

Features

- Low gate charge
- 100% avalanche tested
- Improved dv/dt capability
- RoHS compliant
- JEDEC Qualification

$$V_{DSS} = 660 \text{ V @ } T_{jmax}$$

$$I_D = 20 \text{ A}$$

$$R_{DS(on)} = 0.33 \Omega(\text{max}) @ V_{GS} = 10 \text{ V}$$

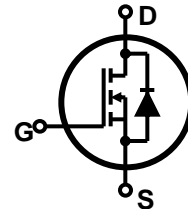
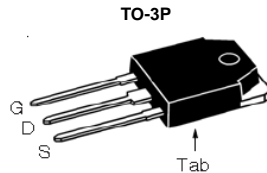

Device	Package	Marking	Remark
GP1M020A060M	TO-3P	GP1M020A060M	RoHS

Absolute Maximum Ratings

Parameter	Symbol	Value	Unit
Drain-Source Voltage	V_{DS}	600	V
Gate-Source Voltage	V_{GS}	±30	V
Continuous Drain Current	I_D	$T_C = 25 \text{ }^\circ\text{C}$	20
		$T_C = 100 \text{ }^\circ\text{C}$	12.4
Pulsed Drain Current (Note 1)	I_{DM}	80	A
Single Pulse Avalanche Energy (Note 2)	E_{AS}	1330	mJ
Repetitive Avalanche Current (Note 1)	I_{AR}	20	A
Repetitive Avalanche Energy (Note 1)	E_{AR}	34.7	mJ
Power Dissipation	P_D	$T_C = 25 \text{ }^\circ\text{C}$	347
		Derate above 25 °C	2.77
Peak Diode Recovery dv/dt (Note 3)	dv/dt	4.5	V/ns
Operating Junction and Storage Temperature Range	T_J, T_{STG}	-55~150	°C
Maximum lead temperature for soldering purposes, 1/8" from case for 5 seconds	T_L	300	°C

* Limited only by maximum junction temperature

Thermal Characteristics

Parameter	Symbol	Value	Unit
Maximum Thermal resistance, Junction-to-Case	$R_{\theta JC}$	0.36	°C/W
Maximum Thermal resistance, Junction-to-Ambient	$R_{\theta JA}$	62.5	°C/W

Electrical Characteristics : $T_C=25^\circ\text{C}$, unless otherwise noted

Parameter	Symbol	Test condition	Min	Typ	Max	Units
OFF						
Drain-Source Breakdown Voltage	BV_{DSS}	$V_{GS} = 0\text{ V}, I_D = 250\ \mu\text{A}$	600	--	--	V
Zero Gate Voltage Drain Current	I_{DSS}	$V_{DS} = 600\text{ V}, V_{GS} = 0\text{ V}$	--	--	1	μA
		$V_{DS} = 480\text{ V}, T_C = 125^\circ\text{C}$	--	--	10	μA
Forward Gate-Source Leakage Current	I_{GSSF}	$V_{GS} = 30\text{ V}, V_{DS} = 0\text{ V}$	--	--	100	nA
Reverse Gate-Source Leakage Current	I_{GSSR}	$V_{GS} = -30\text{ V}, V_{DS} = 0\text{ V}$	--	--	-100	nA

ON

Gate Threshold Voltage	$V_{GS(th)}$	$V_{DS} = V_{GS}, I_D = 250\ \mu\text{A}$	2	--	4	V
Drain-Source On-Resistance	$R_{DS(on)}$	$V_{GS} = 10\text{ V}, I_D = 10\text{ A}$	--	0.27	0.33	Ω
Forward Transconductance ^(Note 4)	g_{FS}	$V_{DS} = 30\text{ V}, I_D = 10\text{ A}$	--	30	--	S

DYNAMIC

Input Capacitance	C_{iss}	$V_{DS} = 25\text{ V}, V_{GS} = 0\text{ V},$ $f = 1.0\text{ MHz}$	--	2097	--	pF
Output Capacitance	C_{oss}		--	146	--	pF
Reverse Transfer Capacitance	C_{rss}		--	14	--	pF

SWITCHING

Turn-On Delay Time ^(Note 4,5)	$t_{d(on)}$	$V_{DD} = 300\text{ V}, I_D = 20\text{ A},$ $R_G = 25\ \Omega$	--	73	--	ns
Turn-On Rise Time ^(Note 4,5)	t_r		--	63	--	ns
Turn-Off Delay Time ^(Note 4,5)	$t_{d(off)}$		--	384	--	ns
Turn-Off Fall Time ^(Note 4,5)	t_f		--	72	--	ns
Total Gate Charge ^(Note 4,5)	Q_g	$V_{DS} = 480\text{ V}, I_D = 20\text{ A},$ $V_{GS} = 10\text{ V}$	--	76	--	nC
Gate-Source Charge ^(Note 4,5)	Q_{gs}		--	14.4	--	nC
Gate-Drain Charge ^(Note 4,5)	Q_{gd}		--	25	--	nC

SOURCE DRAIN DIODE

Maximum Continuous Drain-Source Diode Forward Current	I_S	---	--	--	20	A
Maximum Pulsed Drain-Source Diode Forward Current	I_{SM}	---	--	--	80	A
Drain-Source Diode Forward Voltage	V_{SD}	$V_{GS} = 0\text{ V}, I_S = 20\text{ A}$	--	--	1.5	V
Reverse Recovery Time ^(Note 4)	t_{rr}	$V_{GS} = 0\text{ V}, I_S = 20\text{ A}$ $di_F / dt = 100\text{ A}/\mu\text{s}$	--	452	--	ns
Reverse Recovery Charge ^(Note 4)	Q_{rr}		--	5.9	--	μC

Note :

1. Repeated rating : Pulse width limited by safe operating area
2. $L=6.1\text{mH}, I_{AS} = 20\text{A}, V_{DD} = 50\text{V}, R_G = 25\Omega$, Starting $T_J = 25^\circ\text{C}$
3. $I_{SD} \leq 20\text{A}, di/dt \leq 200\text{A}/\mu\text{s}, V_{DD} \leq BV_{DS}$, Starting $T_J = 25^\circ\text{C}$
4. Pulse Test : Pulse width $\leq 300\mu\text{s}$, Duty Cycle $\leq 2\%$
5. Essentially Independent of Operating Temperature Typical Characteristics

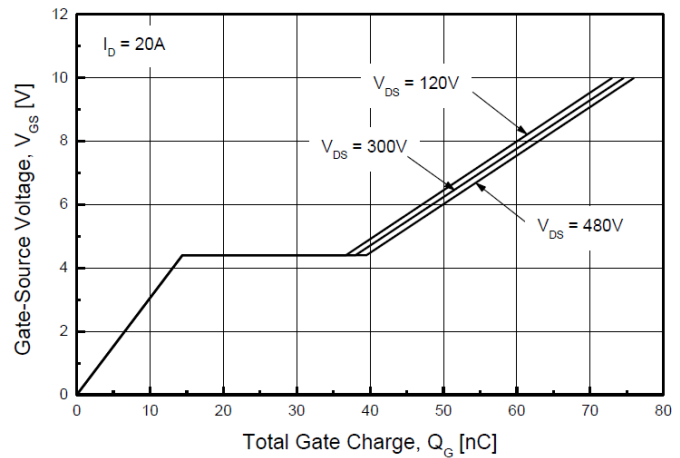
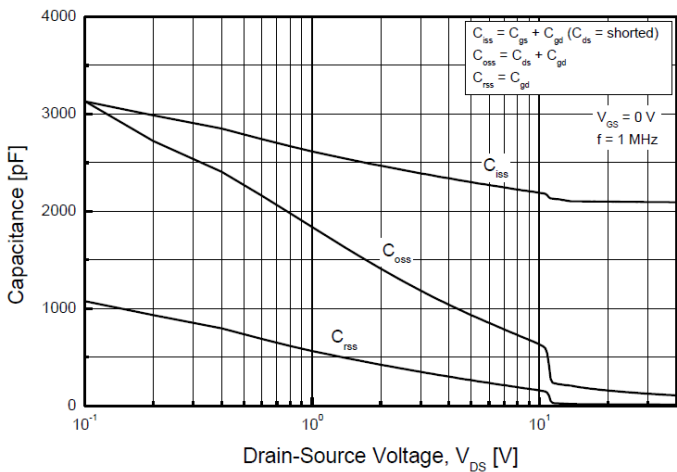
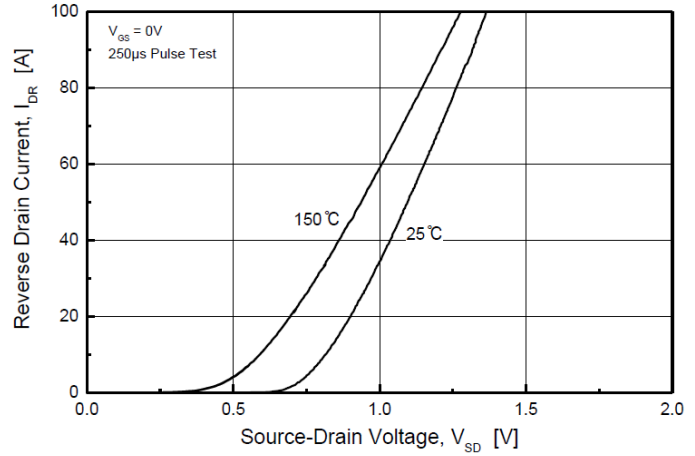
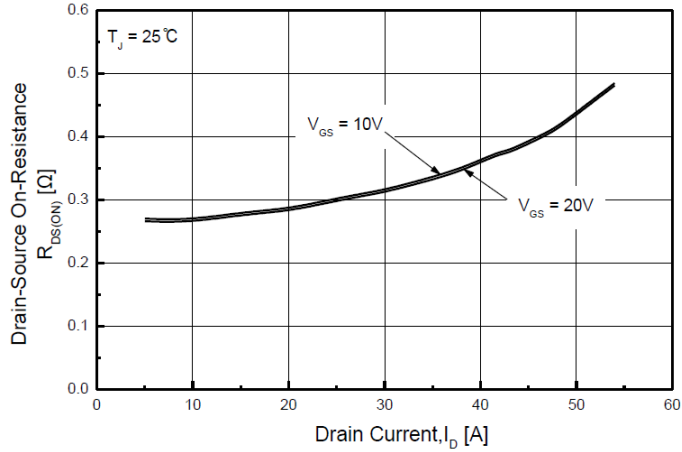
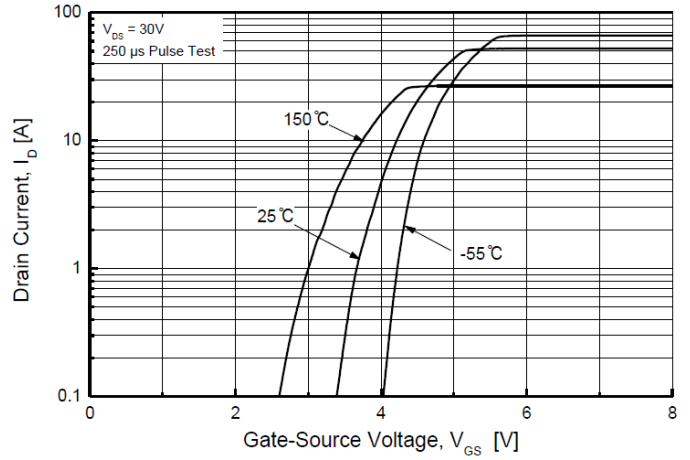
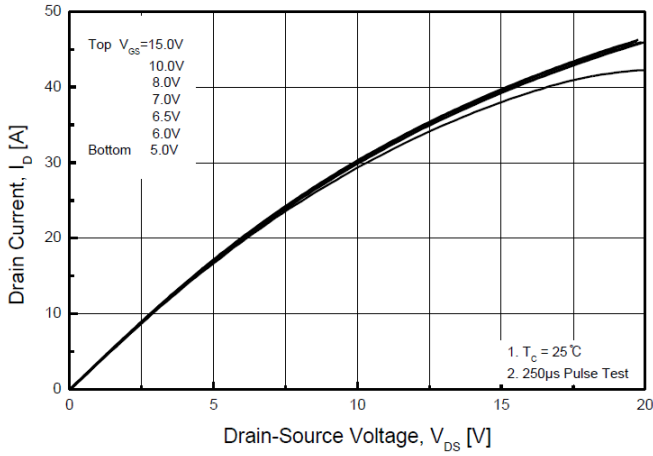

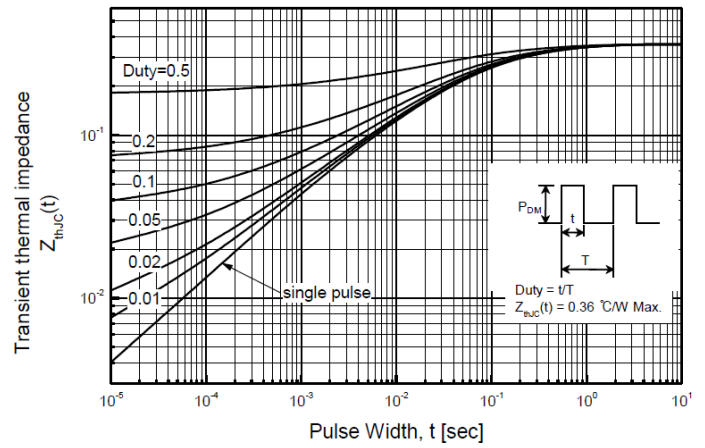
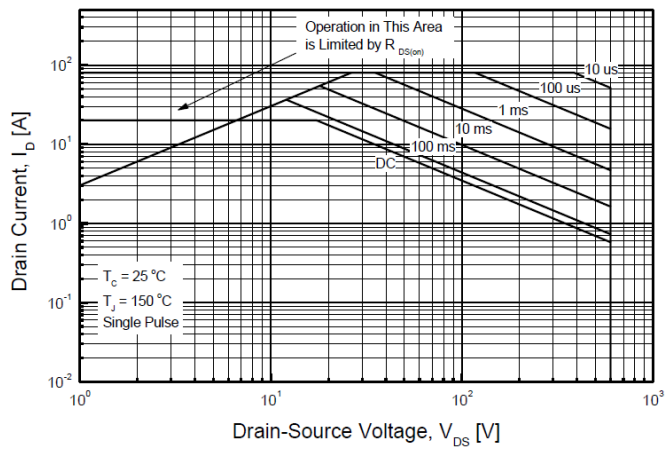
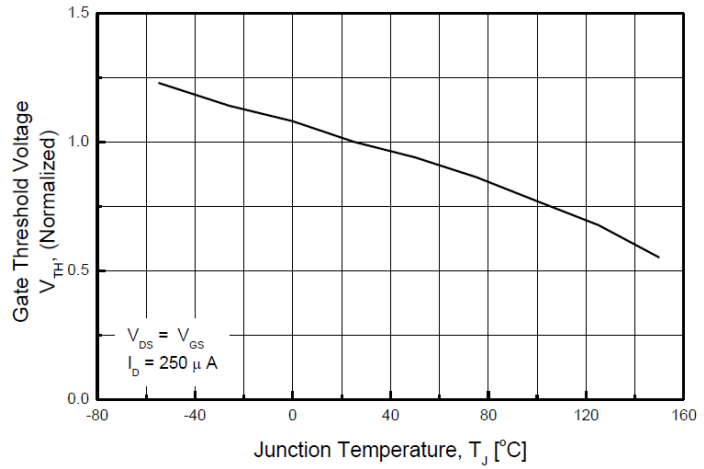
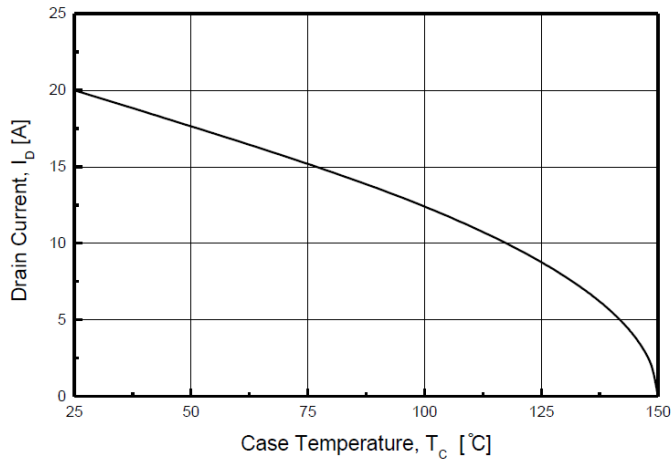
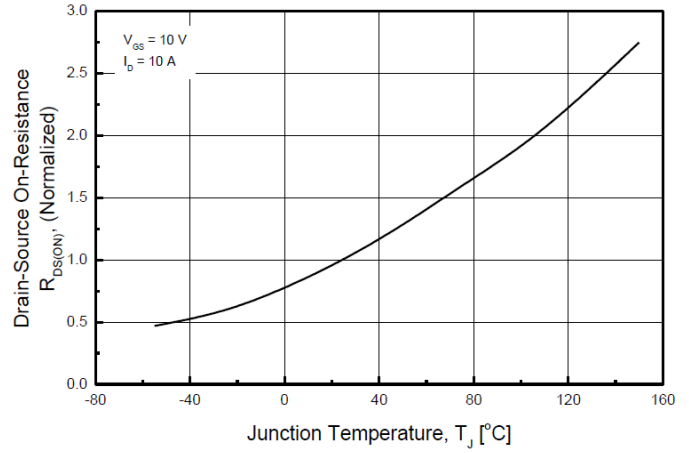
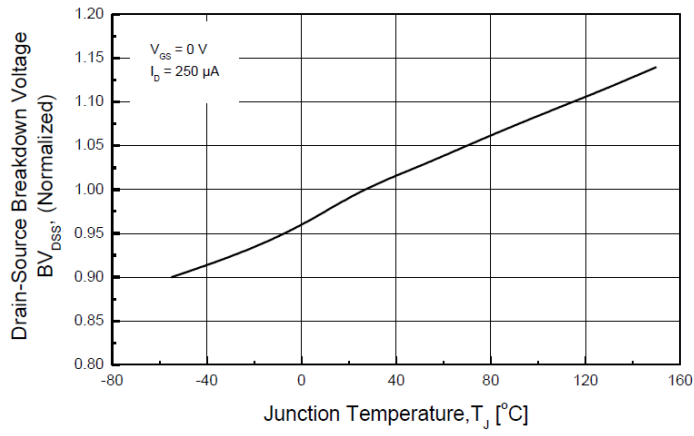

TO-3P MECHANICAL DATA

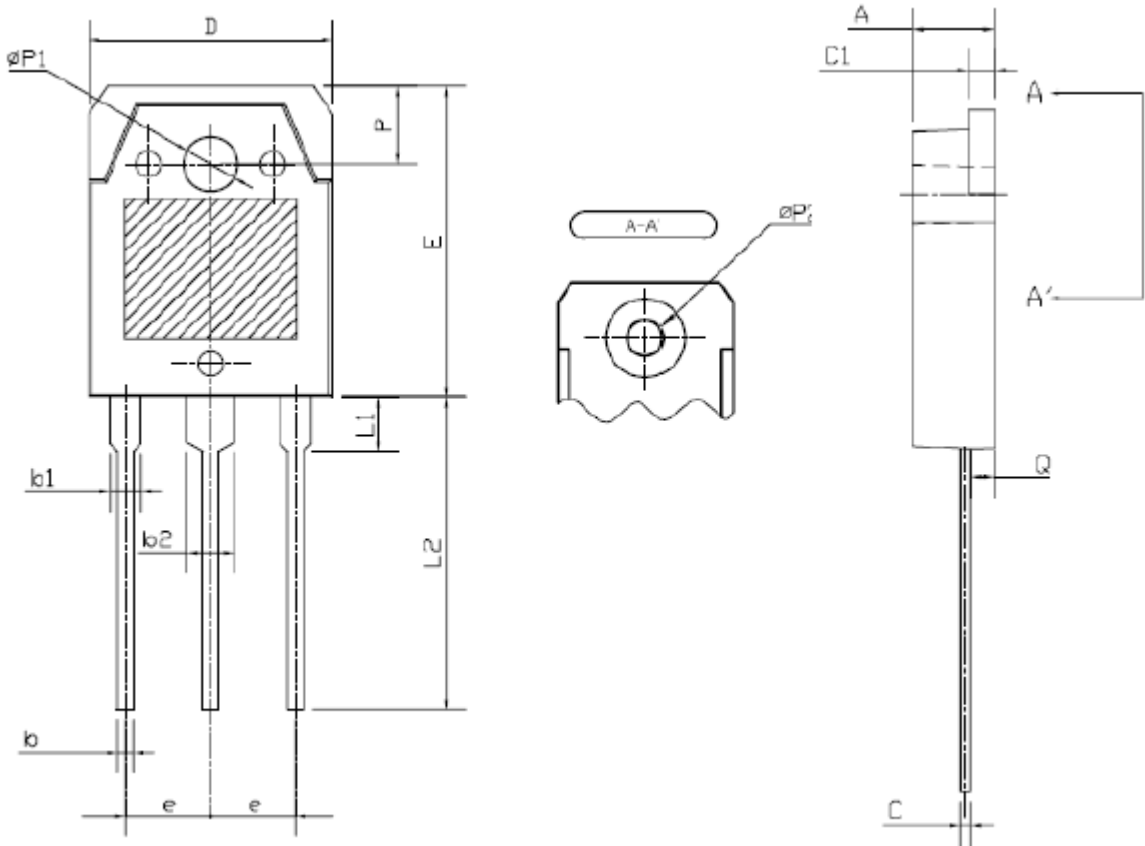

SYMBOL	MIN	NOM	MAX
A	4.60	4.80	5.00
b	0.80	1.00	1.20
b1	1.80	2.00	2.20
b2	2.80	3.00	3.20
C	0.55	0.60	0.75
C1	1.45	1.50	1.65
D	15.40	15.60	15.80
E	19.70	19.90	20.10
e	5.15	5.45	5.75
L1	3.30	3.50	3.70
L2	19.80	20.00	20.20
P	4.80	5.00	5.20
$\phi P1$	3.30	3.40	3.50
$\phi P2$	(3.20)		
Q	1.20	1.40	1.60

Disclaimer :

Global Power Technologies Group reserves the right to make changes without notice to products herein to improve reliability, performance, or design. The information given in this document is believed to be accurate and reliable. However, it shall in no event be regarded as a guarantee of conditions and characteristics. With respect to any information regarding the application of the device, Global Power Technologies Group hereby disclaims any and all warranties and liabilities of any kind, including without limitation, warranties of non-infringement of patent rights of any third party.