

# NB4N855SMEVB

## Evaluation Board User's Manual for NB4N855S



ON Semiconductor®

<http://onsemi.com>

### EVAl BOARD USER'S MANUAL

#### Description

ON Semiconductor has developed an evaluation board for the NB4N855S device as a convenience for the customers interested in performing their own device engineering assessment. This board provides a high bandwidth 50  $\Omega$  controlled impedance environment. The pictures in Figure 1 show the top and bottom view of the evaluation board, which can be configured in several different ways.

This NB4N855S evaluation board manual contains:

- Appropriate Lab Setup
- Assembly Instructions
- Bill of Materials

This manual should be used in conjunction with the NB4N855S device data sheet, which contains full technical details on the device specifications and operation.

#### Board Lay-Up

The NB4N855S evaluation board is implemented in four layers with split (dual) power supplies (Figure 6, Evaluation Board Lay-up). For standard lab setup, a split (dual) power supply is essential to enable the 50  $\Omega$  internal impedance in the oscilloscope as a devices termination. The first layer or primary trace layer is 0.005" thick Rogers RO4003 material, which is designed to have equal electrical length on all signal traces from the device under the test (DUT) to the sense output. The second layer is the 1.0 oz copper ground plane. The FR4 dielectric material is placed between second and third layer and between third and fourth layer. The third layer is also 1.0 oz copper ground plane. The fourth layer is the secondary trace layer.

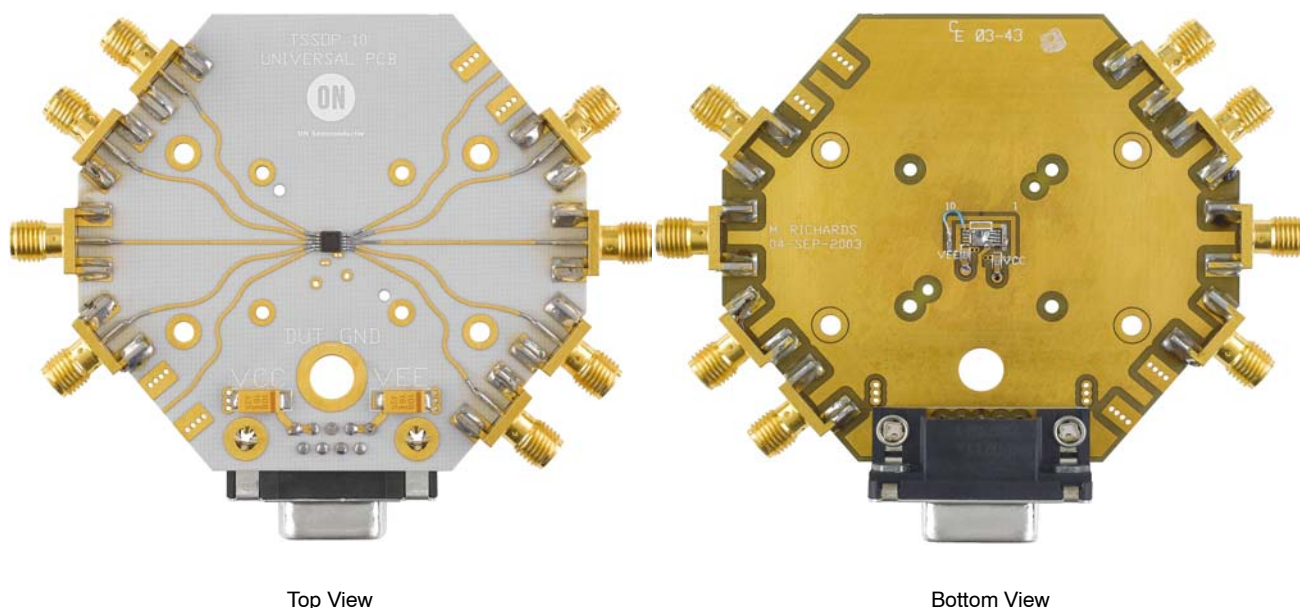

Figure 1. Top and Bottom View of the NB4N855S Evaluation Board

4-LAYER STACKUP

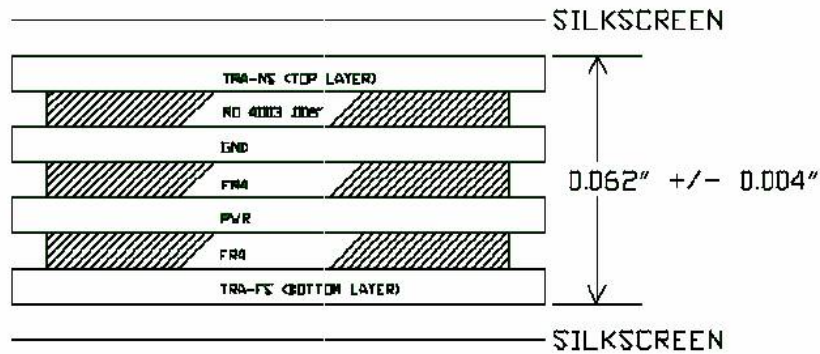

Figure 2. Evaluation Board Lay-up

Connecting Power and Ground Planes

The side launch 9 pin power supply connector is wired as shown in Figure 3. Test points can be soldered on the top of

the PCB to accommodate easier connections. Exact values that need to be applied can be found in Table 1.

Table 1. Power Supply Levels

Power Supply Span	V <sub>CC</sub> (Pin 10)	V <sub>EE</sub> / GND (Pin 5)	DUT_GND (PCB SMA Ground))
3.0 V	1.75 V	-1.25 V	0 V
3.3 V	2.05 V	-1.25 V	0 V
3.6 V	2.35 V	-1.25 V	0 V

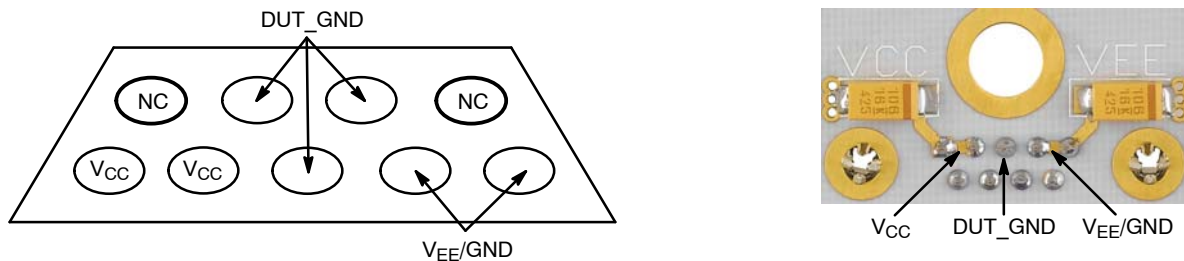

Figure 3. Power Supply Connector – 9 Pin Side View (Left) and PCB Top View (Right)

Stimulus (Generator) Termination

All ECL outputs need to be terminated to V<sub>TT</sub> (V<sub>TT</sub> = V<sub>CC</sub> - 2.0 V = GND) via a 50 Ω resistor. The current board design utilizes the space for placement of the external termination resistors. (More information on termination is provided in AN8020). The 0402 chip resistor pads are provided on the

bottom side of the evaluation board. Solder the chip resistors to the bottom side of the board between the appropriate input of the device pin pads and the ground pads as shown in Figure 4 (for split power supply setup, PCB is assembled in this configuration).

## NB4N855SMEVB

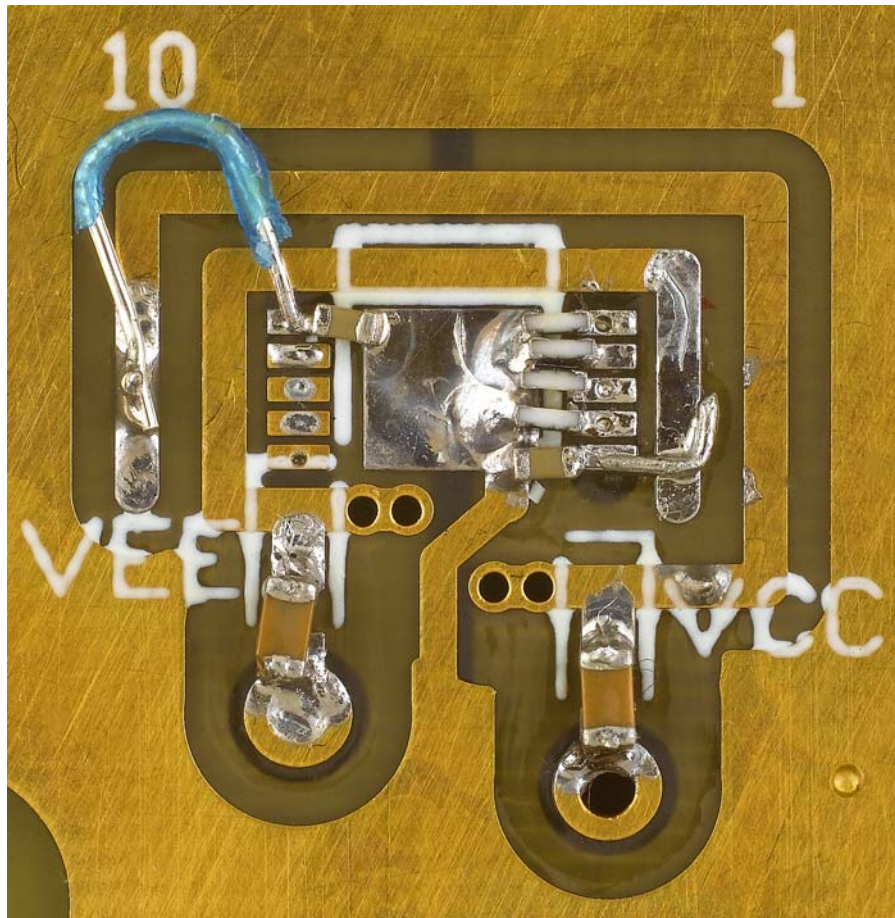

**Figure 4. Expanded Bottom View**

Likewise for CML outputs, CML stimulus signal need to be terminated to  $V_{CC}$  via a  $50\ \Omega$  resistor. To accomplish this configuration the external termination resistor has to be moved from DUT\_GND ring to  $V_{CC}$  ring on the bottom of the board.

For the LVDS configuration Input pin pads of the D0 or D1 input has to be shorted using  $100\ \Omega$  resistor across differential lines.

### DUT Termination

For standard lab setup and test, a split (dual) power supply is required enabling the  $50\ \Omega$  internal impedance in the

oscilloscope to be used as a termination of the signals (in split power supply setup DUT\_GND is the system ground,  $V_{CC}$  is varied, and  $V_{EE}$  is  $-1.25\ \text{V}$ ; see Table 1, Power Supply Levels).

### Board Components Configuration

The NB4N855SMEVB evaluation board requires eight side SMA connectors. Placement locations are described in the Table 2 below.

**Table 2. SMA Connectors and Jumpers Placement**

Device	J1/D0	J2/D0b	J3/D1	J4/D1b	J5	J6/Q1b	J7/Q1	J8/Q0	J9/Q0b	J10
Pin #	1	2	3	4	5	6	7	8	9	10
Connector	Yes	Yes	Yes	Yes	No	Yes	Yes	Yes	Yes	No
Resistor (bottom)	0402 $50\ \Omega$	0402 $50\ \Omega$	0402 $50\ \Omega$	0402 $50\ \Omega$	0402 $0.01\ \mu\text{F}$	No	No	No	No	0402 $0.01\ \mu\text{F}$
Wire	No	No	No	No	to $V_{EE}/\text{GND}$	No	No	No	No	to $V_{CC}$

## NB4N855SMEVB

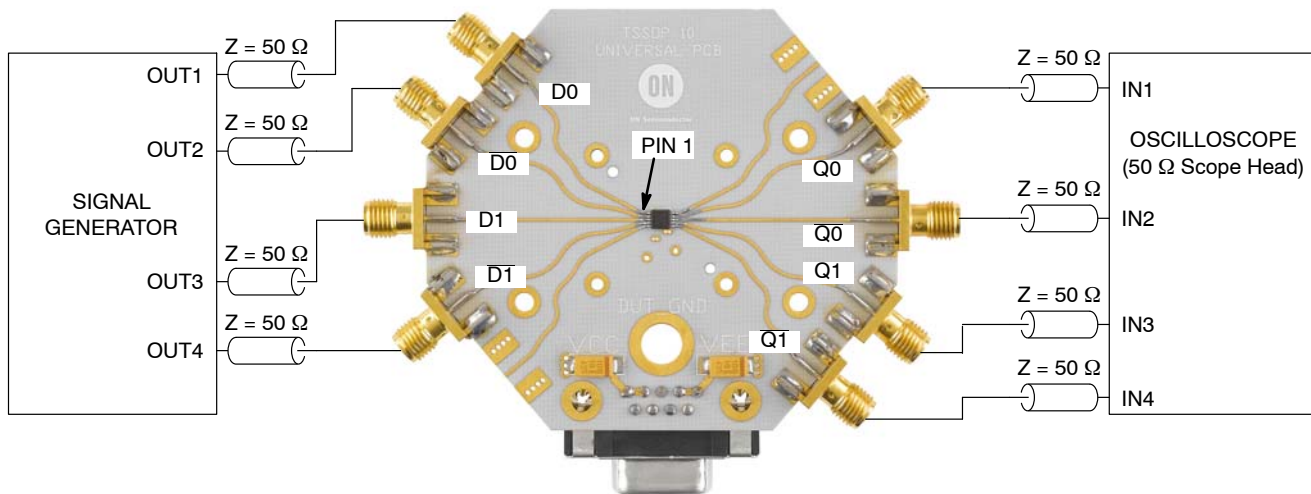

**Figure 5. Lab Setup**

1. Connect appropriate power supplies to  $V_{CC}$ ,  $V_{EE}/GND$  and  $DUT\_GND$  (See Table 1)
2. Connect a signal generator to the input SMA connectors via matched cables. Setup input signal according to the device data sheet.
3. Connect a test measurement device on the device output SMA connectors via matched cables.

NOTE: The test measurement device must contain 50  $\Omega$  termination.

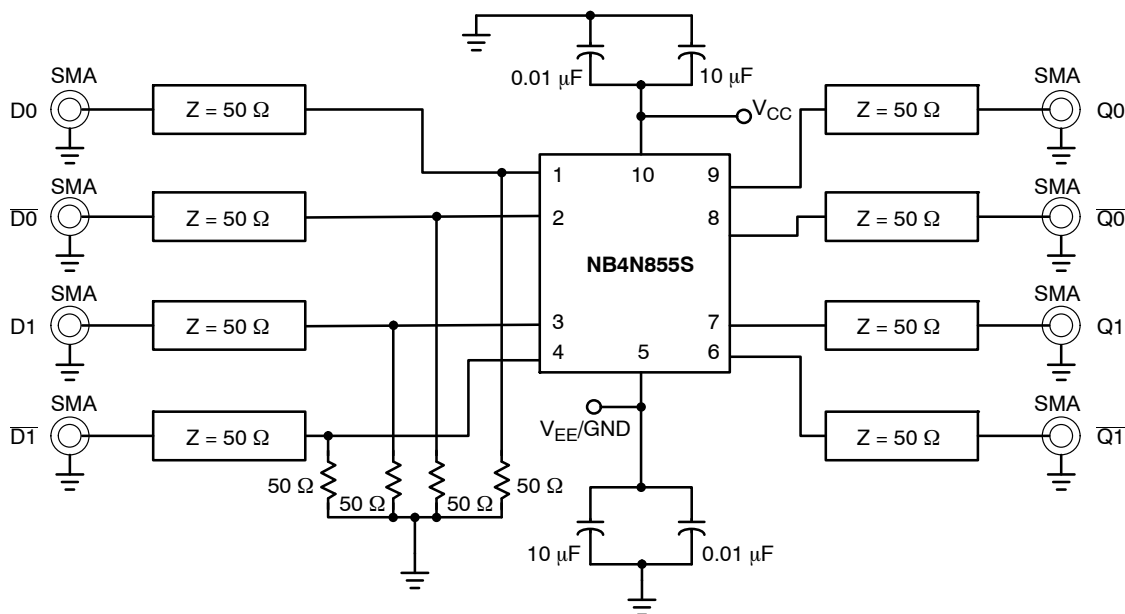

**Figure 6. Evaluation Board Schematic**

## NB4N855SMEVB

**Table 3. Bill of Materials**

Components	Manufacturer	Description	Part Number	Qty.	Web Site
SMA Connector	Johnson*	SMA Connector – Side Launch	142-0701-851	8	<a href="http://www.johnsoncomponents.com">http://www.johnsoncomponents.com</a>
9 Pin D-Sub Receptacle	Amphenol	Connector, Female, 9-Pin, Right Angle	788796-1	1	<a href="http://www.amphenol.com">http://www.amphenol.com</a>
Surface Mount Test Points†	Keystone*	SMT Miniature Test Point	5015	3	<a href="http://www.keyelco.com">http://www.keyelco.com</a>
		SMT Compact Test Point	5016		
Chip Capacitor	AVC Corporation*	0402 0.01 $\mu$ F $\pm$ 10%	04025C103KAT2A	4	<a href="http://www.avxcorp.com">http://www.avxcorp.com</a>
		10 $\mu$ F $\pm$ 10%	T491C106K016AS	2	
Chip Resistor	Panasonic*	0402 50 $\Omega$ $\pm$ 1% Precision Thick Film Chip Resistor	ERJ-2RKF49R9X	4	<a href="http://www.panasonic.com">http://www.panasonic.com</a>
Evaluation Board	ON Semiconductor	Micro-10 Evaluation Board	N/A	1	<a href="http://www.onsemi.com">http://www.onsemi.com</a>
Device Samples	ON Semiconductor	Micro-10 Package Device	NB4N855SM	1	<a href="http://www.onsemi.com">http://www.onsemi.com</a>

\*Components are available through most distributors, i.e. [www.newark.com](http://www.newark.com), [www.Digikey.com](http://www.digikey.com)

†Surface Mount Test Points can be used for power supply connection in place of power supply cable connector. See Figure 3 for test point placement.

# NB4N855SMEVB

## PACKAGE DIMENSIONS

Micro-10  
CASE 846B-03  
ISSUE D

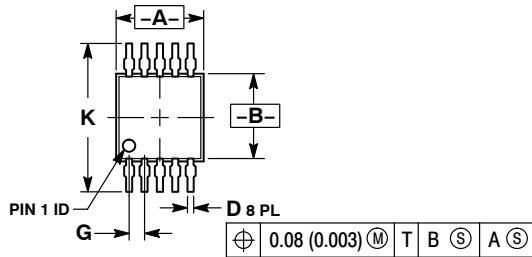

NOTES:

1. DIMENSIONING AND TOLERANCING PER ANSI Y14.5M, 1982.
2. CONTROLLING DIMENSION: MILLIMETER.
3. DIMENSION "A" DOES NOT INCLUDE MOLD FLASH, PROTRUSIONS OR GATE BURRS. MOLD FLASH, PROTRUSIONS OR GATE BURRS SHALL NOT EXCEED 0.15 (0.006) PER SIDE.
4. DIMENSION "B" DOES NOT INCLUDE INTERLEAD FLASH OR PROTRUSION. INTERLEAD FLASH OR PROTRUSION SHALL NOT EXCEED 0.25 (0.010) PER SIDE.
5. 846B-01 OBSOLETE. NEW STANDARD 846B-02

DIM	MILLIMETERS		INCHES	
	MIN	MAX	MIN	MAX
A	2.90	3.10	0.114	0.122
B	2.90	3.10	0.114	0.122
C	0.95	1.10	0.037	0.043
D	0.20	0.30	0.008	0.012
G	0.50 BSC		0.020 BSC	
H	0.05	0.15	0.002	0.006
J	0.10	0.21	0.004	0.008
K	4.75	5.05	0.187	0.199
L	0.40	0.70	0.016	0.028

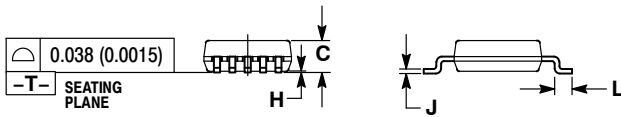

### SOLDERING FOOTPRINT\*

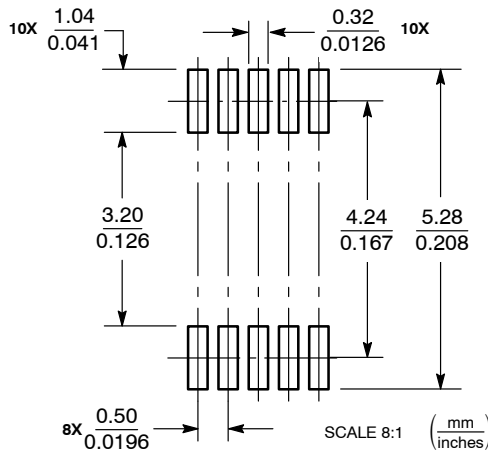

\*For additional information on our Pb-Free strategy and soldering details, please download the ON Semiconductor Soldering and Mounting Techniques Reference Manual, SOLDERRM/D.

ON Semiconductor and are registered trademarks of Semiconductor Components Industries, LLC (SCILLC). SCILLC reserves the right to make changes without further notice to any products herein. SCILLC makes no warranty, representation or guarantee regarding the suitability of its products for any particular purpose, nor does SCILLC assume any liability arising out of the application or use of any product or circuit, and specifically disclaims any and all liability, including without limitation special, consequential or incidental damages. "Typical" parameters which may be provided in SCILLC data sheets and/or specifications can and do vary in different applications and actual performance may vary over time. All operating parameters, including "Typicals" must be validated for each customer application by customer's technical experts. SCILLC does not convey any license under its patent rights nor the rights of others. SCILLC products are not designed, intended, or authorized for use as components in systems intended for surgical implant into the body, or other applications intended to support or sustain life, or for any other application in which the failure of the SCILLC product could create a situation where personal injury or death may occur. Should Buyer purchase or use SCILLC products for any such unintended or unauthorized application, Buyer shall indemnify and hold SCILLC and its officers, employees, subsidiaries, affiliates, and distributors harmless against all claims, costs, damages, and expenses, and reasonable attorney fees arising out of, directly or indirectly, any claim of personal injury or death associated with such unintended or unauthorized use, even if such claim alleges that SCILLC was negligent regarding the design or manufacture of the part. SCILLC is an Equal Opportunity/Affirmative Action Employer. This literature is subject to all applicable copyright laws and is not for resale in any manner.

### PUBLICATION ORDERING INFORMATION

**LITERATURE FULFILLMENT:**  
Literature Distribution Center for ON Semiconductor  
P.O. Box 5163, Denver, Colorado 80217 USA  
**Phone:** 303-675-2175 or 800-344-3860 Toll Free USA/Canada  
**Fax:** 303-675-2176 or 800-344-3867 Toll Free USA/Canada  
**Email:** orderlit@onsemi.com

**N. American Technical Support:** 800-282-9855 Toll Free USA/Canada  
**Europe, Middle East and Africa Technical Support:**  
Phone: 421 33 790 2910  
**Japan Customer Focus Center**  
Phone: 81-3-5817-1050

**ON Semiconductor Website:** [www.onsemi.com](http://www.onsemi.com)  
**Order Literature:** <http://www.onsemi.com/orderlit>

For additional information, please contact your local Sales Representative