

SPECIFICATIONS



Model Number: MDD12K1E2X-E3
Part Number: 17001165A

Version: 00
Jun. 12, 2018

Mechanical Drawing:

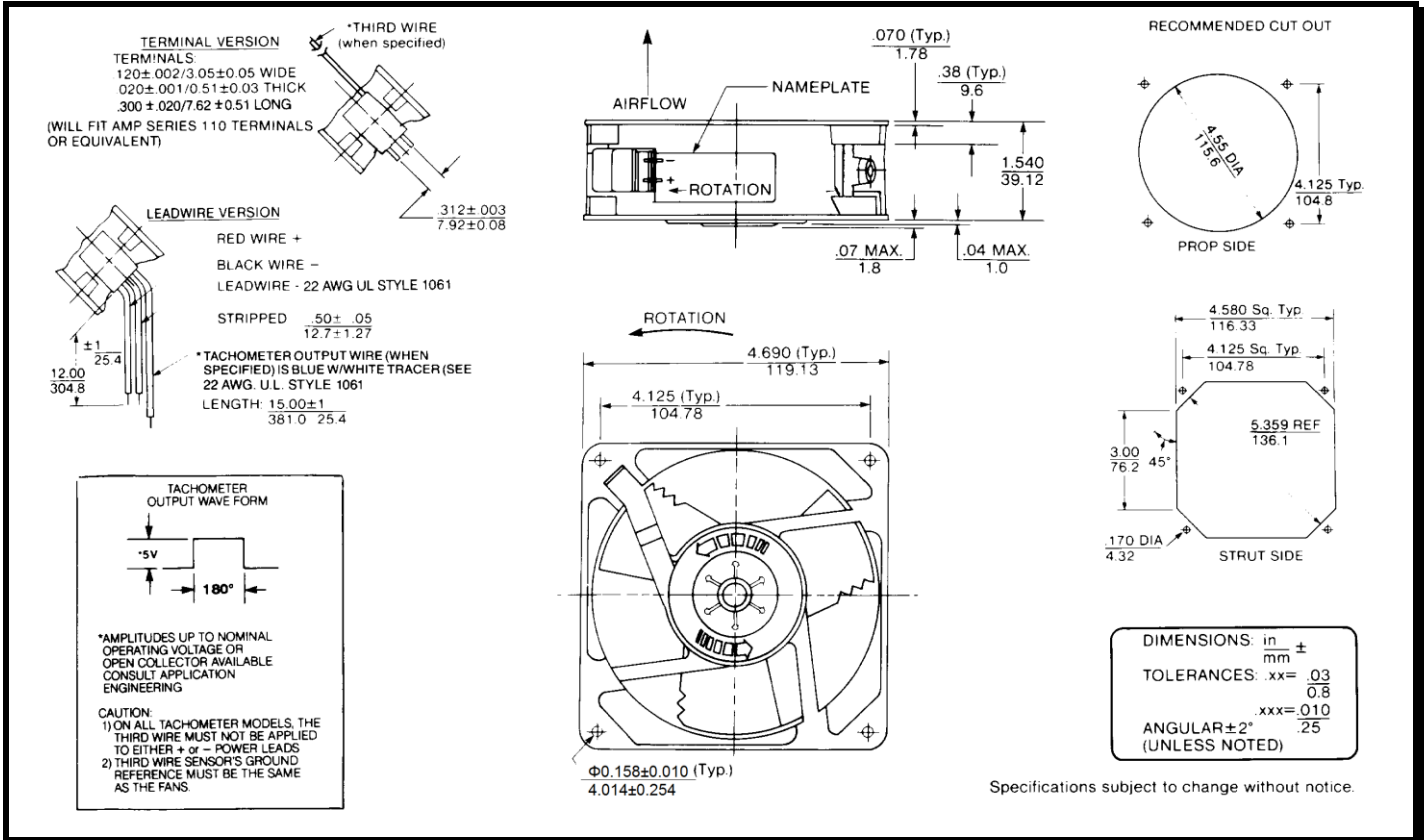

Motor:

Nominal Voltage = 12 vdc
 Operating Voltage Range = 8 - 16vdc
 Nominal Running Current = 0.72 amps
 Locked Rotor Current = 2.0 amps
 Running Power = 8.6 watts
 Average Speed = 3650 rpm
 Bearings = Ball
 Air Flow = 125 CFM
 Acoustic = 53.5 dBA

Construction:

Venturi: Die-Cast Aluminum, Black
 Propeller: Plastic, Black, UL 94V-0

Life Expectancy:

This fan is designed for continuous duty life of 55,000 hours at 70°C.

Termination:

12"±1" (304.8±25.4mm) 22AWG UL1061 Leadwires
 Red = Power(+)
 Black = Return(-)
 Blue/White = Tach output
 Yellow = PWM control

Additional Features:

Brushless DC Motor
 Automatic Restart Capability
 Electronic Locked Rotor Protection
 Polarity Protected
 Operating Temperature: -10°C to 70°C
 Storage Temperature: -40°C to 85°C
 Environmental Protection: Type 3(IP68)

Tachometer:

Output: Open Collector
 Ic: 20 mA max.
 Vcc: 32 Vdc max.
 Pulses per Revolution: 2
 Isolated: No

Speed Control:

PWM: 200 ~ 2 KHz, Open Collector
 <10% Duty: Off
 10%~95% Duty: Linear Ramp
 >95% Duty or Open Lead Wire: Full Speed

Agencies:

UL, CUL, CE

PQ Curve:

