

# SMD Power Inductor CDRH2D16/LD

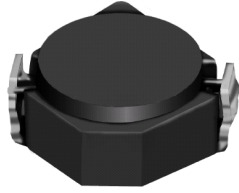

## Description

- Ferrite drum core construction.
- Magnetically shielded.
- L × W × H: 3.2 × 3.2 × 1.8mm Max.
- Product weight: 60mg(Ref.)
- Moisture Sensitivity Level: 1
- RoHS compliance.

## Environmental Data

- Operating temperature range: -40°C ~ +100°C (including coil's self temperature rise)
- Storage temperature range: -40°C ~ +100°C
- Solder reflow temperature: 260 °C peak.

## Packaging

- Carrier tape and reel packaging
- 7.0" diameter reel
- 1000pcs per reel

## Applications

- Ideally used in Mobilephone, PDA, MP3, DSC/DVC, etc. as DC-DC converter inductors.

## Dimension - [mm]

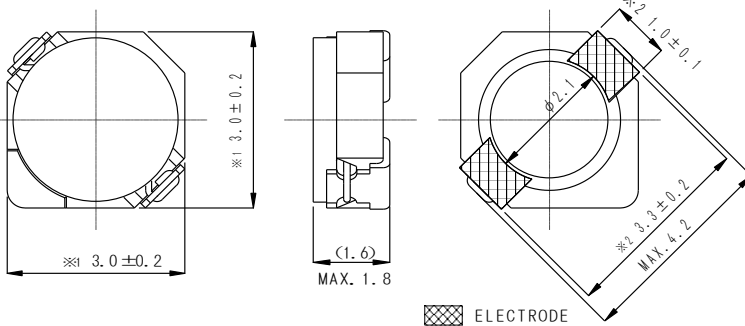

## Land pattern and Schematics - [mm]

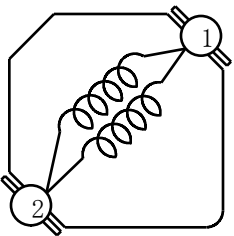
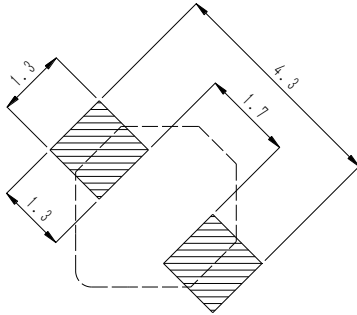

(2.2μH ~ 4.7μH)

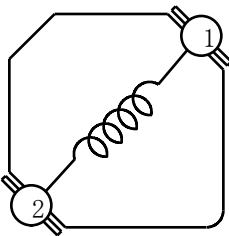

(5.6μH ~ 27μH)

# SMD Power Inductor CDRH2D16/LD



## Electrical Characteristics

Part Name	Stamp	Inductance ( $\mu\text{H}$ ) [ within ] ※1	D.C.R. (m $\Omega$ ) Max. (Typ.) (at 20°C)	Saturation Current (A) ※2		Temperature Rise Current (A) ※3
				at 20°C	at 100°C	
CDRH2D16LDNP-2R2NC	A	2.2 $\pm$ 30%	47(38)	0.86	0.65	2.20
CDRH2D16LDNP-2R7NC	B	2.7 $\pm$ 30%	61(49)	0.82	0.60	1.90
CDRH2D16LDNP-3R3NC	C	3.3 $\pm$ 30%	67(54)	0.72	0.52	1.74
CDRH2D16LDNP-3R9NC	D	3.9 $\pm$ 30%	75(60)	0.70	0.48	1.60
CDRH2D16LDNP-4R7NC	E	4.7 $\pm$ 30%	101(81)	0.62	0.45	1.32
CDRH2D16LDNP-5R6NC	F	5.6 $\pm$ 30%	123(98)	0.57	0.40	1.25
CDRH2D16LDNP-6R8NC	G	6.8 $\pm$ 30%	158(127)	0.50	0.35	1.00
CDRH2D16LDNP-8R2NC	H	8.2 $\pm$ 30%	171(137)	0.45	0.33	0.95
CDRH2D16LDNP-100NC	I	10.0 $\pm$ 30%	195(156)	0.42	0.30	0.92
CDRH2D16LDNP-120NC	J	12.0 $\pm$ 30%	223(179)	0.39	0.28	0.85
CDRH2D16LDNP-150NC	K	15.0 $\pm$ 30%	248(198)	0.35	0.26	0.81
CDRH2D16LDNP-180NC	L	18.0 $\pm$ 30%	316(252)	0.32	0.23	0.73
CDRH2D16LDNP-220NC	M	22.0 $\pm$ 30%	418(335)	0.28	0.21	0.60
CDRH2D16LDNP-270NC	N	27.0 $\pm$ 30%	466(373)	0.26	0.18	0.53

※1 Inductance measuring condition: at 100 kHz.

※2 Saturation current: The DC current at which the inductance decreases to 65% of its nominal value.

※3 Temperature rise current: The DC current at which the temperature rise is  $\Delta T = 40^\circ\text{C}$ . ( $T_a = 20^\circ\text{C}$ )

# SMD Power Inductor CDRH2D16/LD



## Saturation Current & Temperature Rise Graph

— L (20°C) — L (100°C) —  $\Delta T$

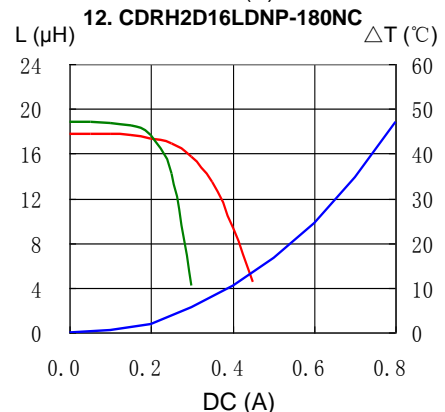
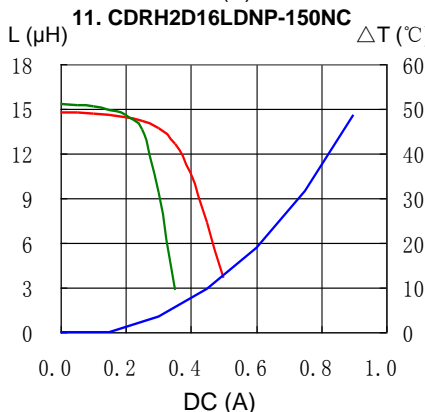
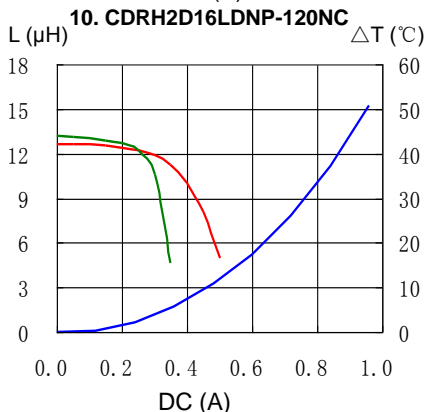
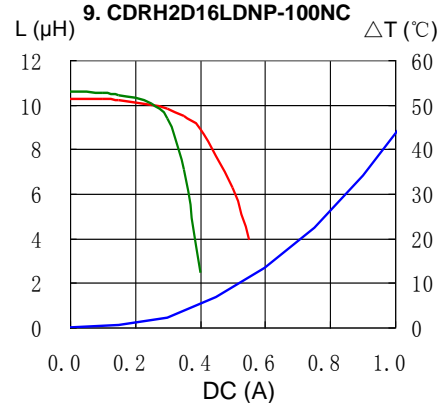
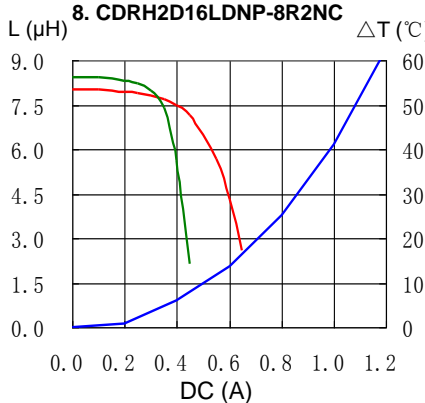
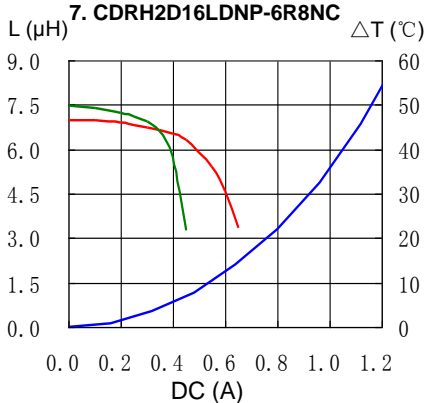
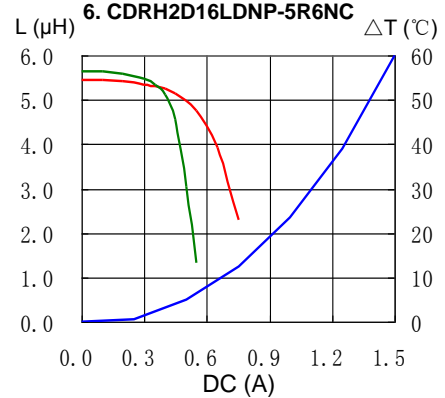
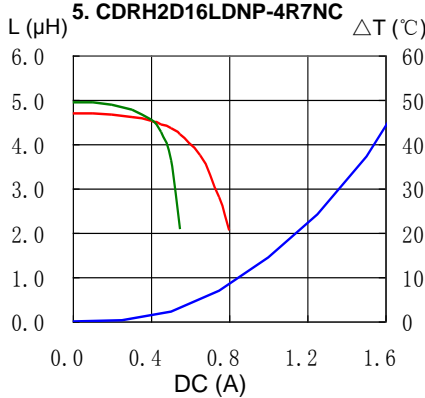
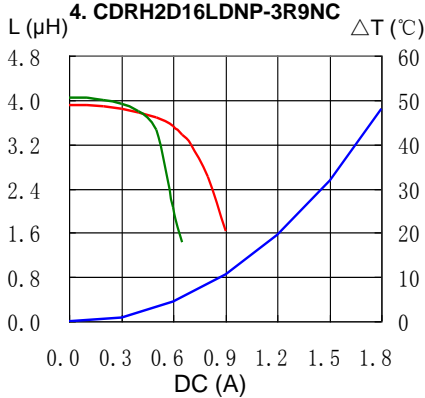
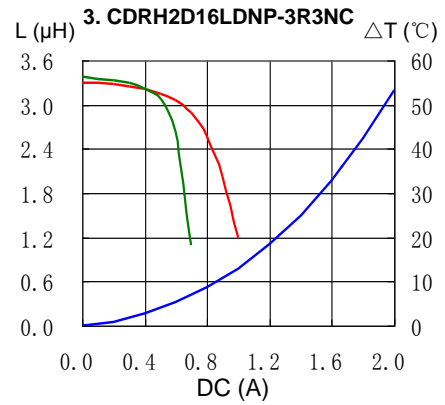
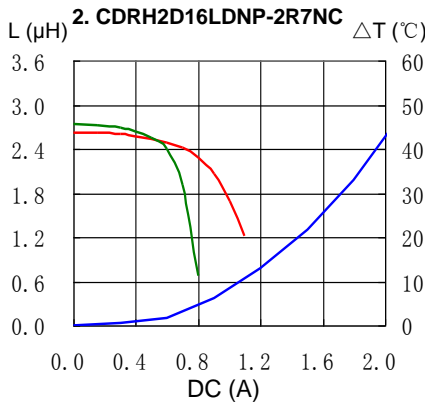
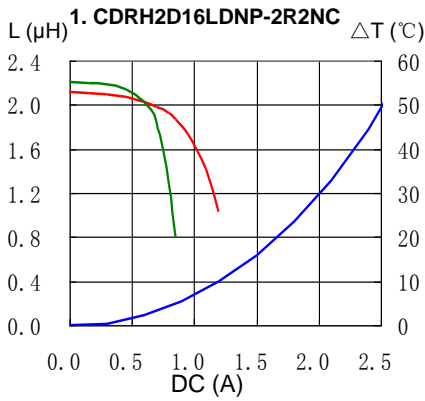

# SMD Power Inductor CDRH2D16/LD



## Saturation Current & Temperature Rise Graph

— L (20°C) — L (100°C) —  $\Delta T$

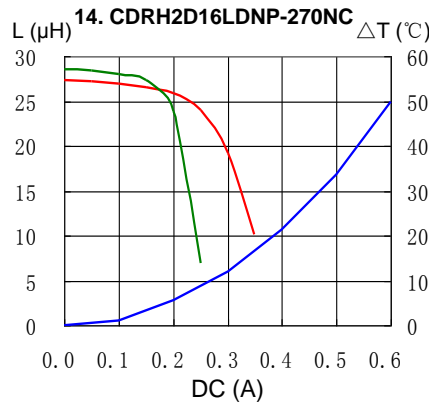
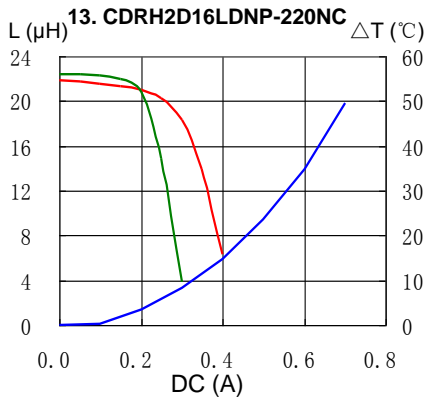

## Solder Reflow Condition

Heat Endurance

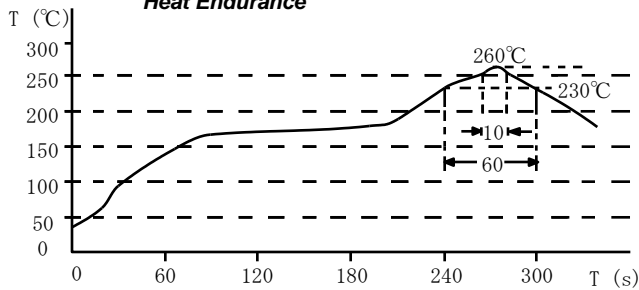

Temperature Chart

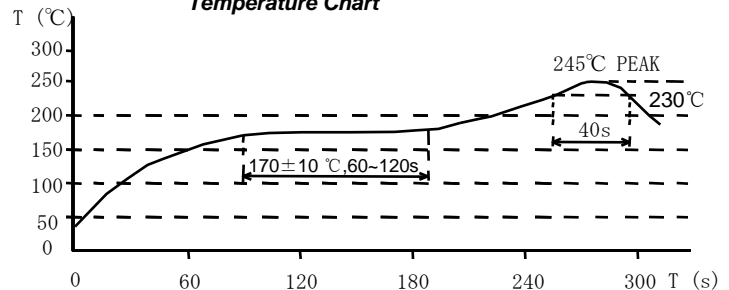

Please refer to the sales offices on our website - <http://www.sumida.com>

### Hong Kong

Tel.+852-2880-6781  
FAX.+852-2565-9600  
[sales@hk.sumida.com](mailto:sales@hk.sumida.com)

### Saitama(Japan)

Tel.+81-48-691-7300  
FAX.+81-48-691-7340  
[sales@jp.sumida.com](mailto:sales@jp.sumida.com)

### Chicago

Tel.+1-847-545-6700  
FAX. +1-847-545-6720  
[sales@us.sumida.com](mailto:sales@us.sumida.com)

### Shanghai

Tel.+86-21-5836-3299  
FAX.+86-21-5836-3266  
[shanghai.sales@cn.sumida.com](mailto:shanghai.sales@cn.sumida.com)

### Seoul

Tel.+82-2-6237-0777  
FAX.+82-2-6237-0778  
[sales@kr.sumida.com](mailto:sales@kr.sumida.com)

### Obernzell

Tel.+49-8591-937-0  
FAX. +49-8591-937-103  
[contact@eu.sumida.com](mailto:contact@eu.sumida.com)

### Shenzhen

Tel.+86-755-8291-0228  
FAX.+86-755-8291-0338  
[shenzhen.sales@cn.sumida.com](mailto:shenzhen.sales@cn.sumida.com)

### Singapore

Tel.+65-6296-3388  
FAX.+65-6841-4426  
[sales@sg.sumida.com](mailto:sales@sg.sumida.com)

### Neumarkt

Tel.+49-9181-4509-110  
FAX. +49-9181-4509-310  
[infocomp@eu.sumida.com](mailto:infocomp@eu.sumida.com)

### Taipei

Tel.+886-2-8751-2737  
FAX.+886-2-8751-2738  
[sales@tw.sumida.com](mailto:sales@tw.sumida.com)

### San Jose

Tel.+1-408-321-9660  
FAX.+1-408-321-9308  
[sales@us.sumida.com](mailto:sales@us.sumida.com)