

TFPMN Series Tuning Fork Crystal

Features

- 32.7680kHz Frequency Reference
- Tuning Fork Crystal Design
- Plastic Molded Surface Mount Package, Narrow Body
- Compatible to Citizen CM310 and Epson MC-146
- Frequency Tolerance, ± 20 ppm Standard
- Parabolic Temperature Coefficient
- Tape and Reel Packaging, EIA-418



Part Dimensions:
6.9 × 1.4 × 1.3mm • 28.2603mg

RoHS Compliant in Accordance with EU Directive 2011/65/EU

- Lead-Free Termination Finish
- Exemption 7(a), Lead [Pb] in high melting temperature type solders

Applications

- Real Time Clock Reference
- FPGAs & Microcontrollers
- Wireless Communications
- Consumer Electronics
- Computer Peripherals
- IoT Applications
- Instrumentation
- Industrial Electronics

Description

CTS TFPMN Series is ideal for supporting wide range of electronic designs requiring a Real Time Clock reference. This series will support general commercial and industrial applications.

Ordering Information

Model		Frequency Tolerance	Load Capacitance	Frequency Code [kHz]	Packaging
TF	PMN	2	P	32K7680	R
Code Package			Code Capacitance		Code Packing
PMN 8.0x3.8mm [Plastic Molded Narrow]			P 12.5pF J 9pF V 7pF		R 3k pcs./reel
		Code @ +25°C		Code Frequency	
		2 ± 20 ppm 1 ± 10 ppm ¹		Product Frequency Code ²	

Notes:

- 1] Check factory for availability.
- 2] Frequency is recorded with two leading digits before the 'K' and 4 significant digits after the 'K' [including zeros].

**Not all performance combinations and frequencies may be available.
Contact your local CTS Representative or CTS Customer Service for availability.**

This product is specified for use only in standard commercial applications. Supplier disclaims all express and implied warranties and liability in connection with any use of this product in any non-commercial applications or in any application that may expose the product to conditions that are outside of the tolerances provided in its specification.

Electrical Specifications

Operating Conditions

PARAMETER	SYMBOL	CONDITIONS	MIN	TYP	MAX	UNIT
Operating Temperature	T _A	-	-40	+25	+85	°C
Turnover Temperature	T _M	-	+20	+25	+30	°C
Storage Temperature	T _{STG}	-	-55	-	+125	°C

Frequency Stability

PARAMETER	SYMBOL	CONDITIONS	MIN	TYP	MAX	UNIT
Frequency	f ₀	-		32.7680		kHz
Frequency Tolerance [Note 1]	Δf/f ₀	Standard @ +25°C	-20	-	20	ppm
Parabolic Coefficient	β	See Figure 1		-0.040 ±0.010		ppm/°C ²
Aging	Δf/f ₀	First Year @ +25°C	-3	-	3	ppm

Crystal Parameters

PARAMETER	SYMBOL	CONDITIONS	MIN	TYP	MAX	UNIT
Operating Mode	-	-		Flexural Mode [Tuning Fork]		-
Load Capacitance [Note 1]	C _L	Standard	-	12.5	-	pF
Shunt Capacitance	C ₀	-	-	0.8	-	pF
Motional Capacitance	C ₁	-	-	1.9	-	fF
Series Resistance	R ₁	-	-	-	65	kΩ
Drive Level	DL	-	-	0.5	1.0	μW
Insulation Resistance	R _i	+100Vdc ±15Vdc	500	-	-	MΩ

1.] See Ordering Information for available options.

Figure 1

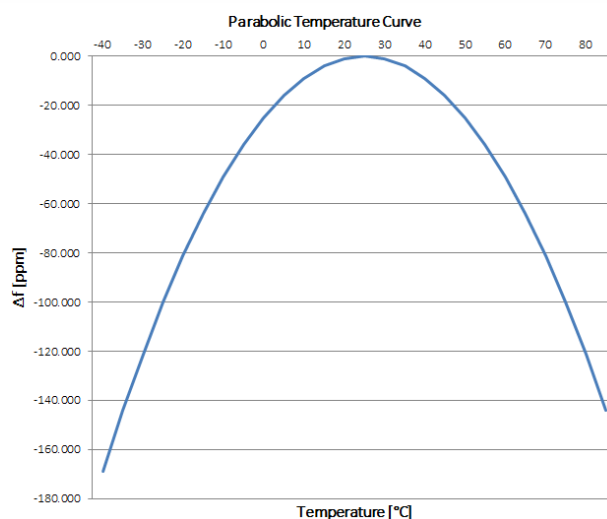

Frequency Stability [Δf] at a given temperature,

$$\Delta f = \beta [T_A - T_M]^2$$

β = Parabolic Coefficient
T_A = Ambient Temperature
T_M = Turnover Temperature

Ex. Find frequency stability at T_A = +45°C
 $\Delta f = -0.040[45-25]^2$
 $\Delta f = -0.040[20]^2$
 $\Delta f = -16.0 \text{ ppm}$

Mechanical Specifications

Package Drawing

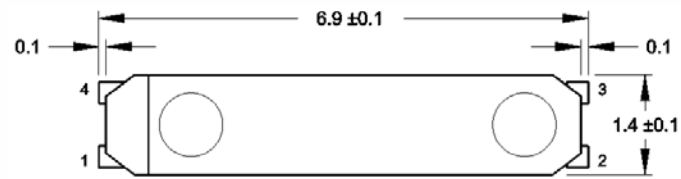

Internal Connection

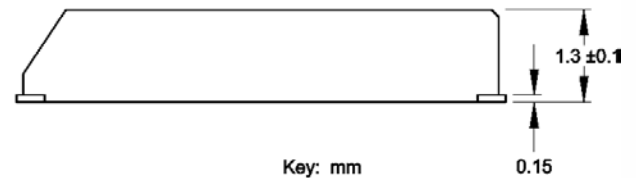
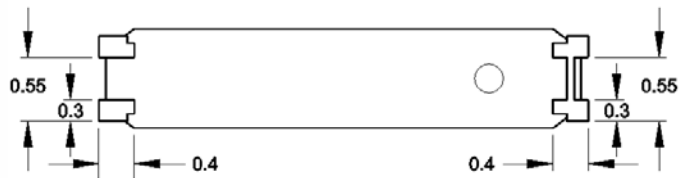
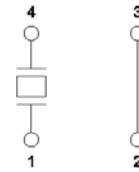

Recommended Pad Layout

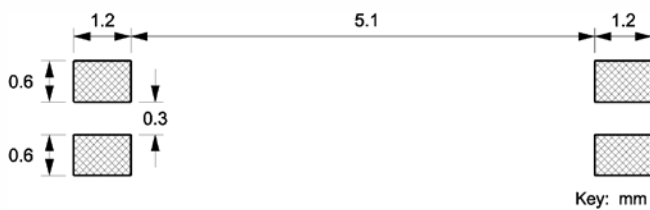

Marking Information

Refer to document 016-0071-0, TF Marking Guide, for marking formats by product platform.

Notes

1. JEDEC termination code (e3). Barrier-plating is nickel [Ni] with tin [Sn] plate.
2. Reflow conditions per JEDEC J-STD-020; +260°C maximum, 5 seconds.
3. MSL = 1.

Packaging - Tape and Reel

Tape Drawing

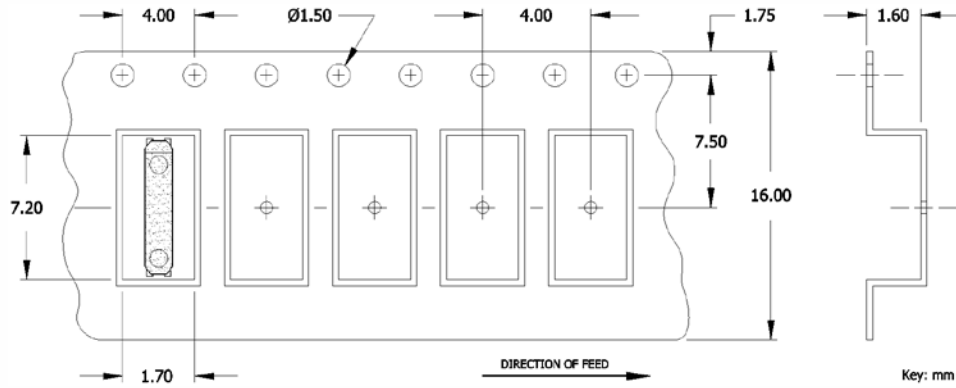

Reel Drawing

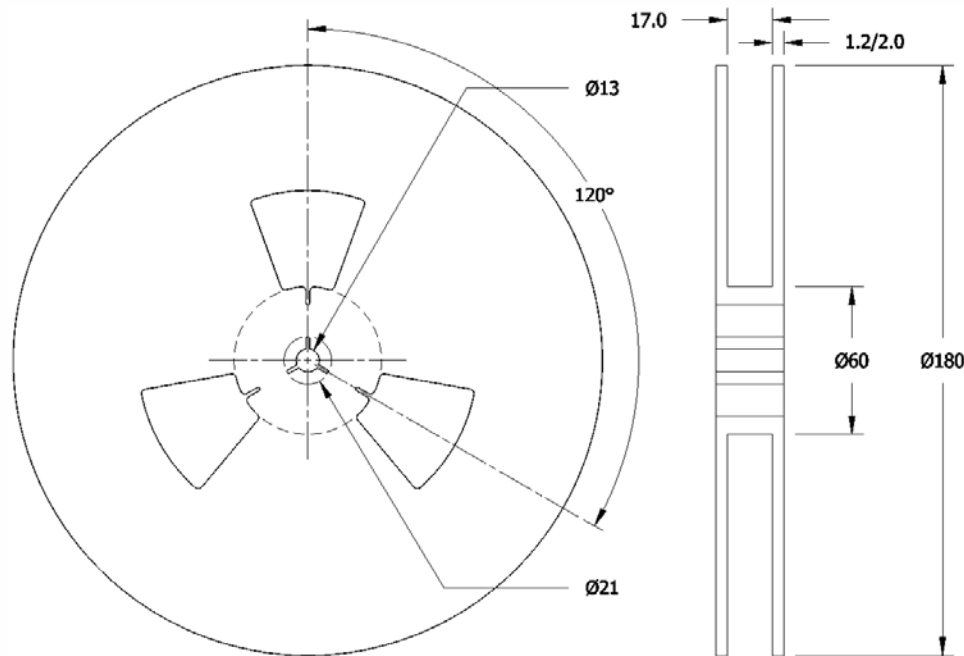

Notes

1. Device quantity is 3k pieces maximum per 180mm reel.
2. Complete CTS part number, frequency value, date code and manufacturing site code information must appear on reel and carton labels.