

## 3-line IPAD™, EMI filter including ESD protection

### Features

- EMI symmetrical (I/O) low-pass filter
- high efficiency in EMI/ESD protection
- lead-free package
- very thin package
- high reliability offered by monolithic integration
- high reduction of parasitic elements through integration and wafer level packaging

### Complies with the following standards

- IEC 61000-4-2 level 4:
  - ± 15 kV (air discharge)
  - ± 8 kV (contact discharge)
- IEC 61000-4-2 level 1:
  - ± 2 kV (air discharge)
  - ± 2 kV (contact discharge)
- ETSI 102.221 (configuration FIDI = 97)

### Applications

Where EMI filtering in ESD sensitive equipment is required:

- mobile phones and communication systems
- computers, printers and MCU Boards

### Description

The EMIF03-SIM03F3 chip is a very low capacitance EMI filter designed to suppress EMI/RFI noise in all systems subjected to electromagnetic interference.

This filter includes ESD protection circuitry, which prevents damage to the protected device when subjected to ESD surges up to 15 kV.

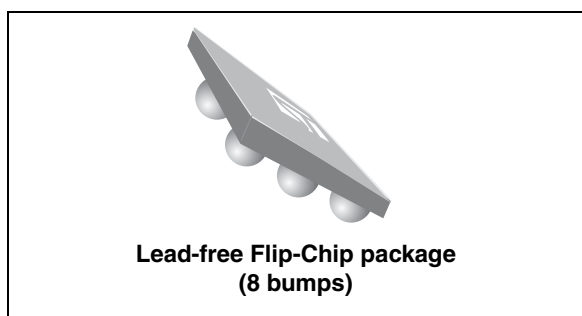

Figure 1. Pin configuration (bump side)

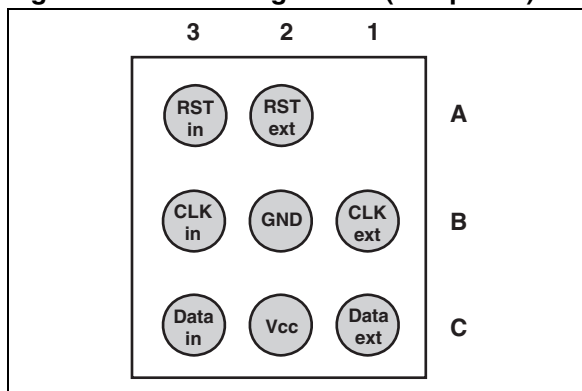
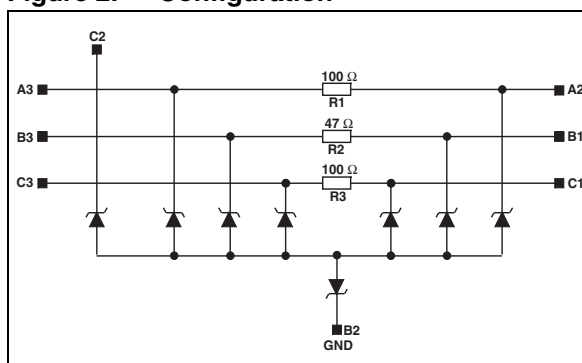

Figure 2. Configuration



TM: IPAD is a trademark of STMicroelectronics.

# 1 Electrical characteristics

**Table 1. Absolute maximum ratings ( $T_{amb} = 25\text{ }^{\circ}\text{C}$ )**

Symbol	Parameter	Value	Unit
$V_{PP}$	<b>Internal pins (A3, B3, C3):</b>		
	ESD discharge IEC 61000-4-2, level 1, air discharge	2	kV
	ESD discharge IEC 61000-4-2, level 1, contact discharge	2	
	<b>External pins (A2, B1, C1, C2):</b>		
ESD discharge IEC 61000-4-2, level 4, air discharge	15		
	ESD discharge IEC 61000-4-2, level 4, contact discharge	8	
$P_d$	Line resistance power dissipation at 70 °C	60	mW
$T_{op}$	Operating temperature range	- 40 to + 85	°C
$T_{stg}$	Storage temperature range	- 55 to 150	°C

**Figure 3. Electrical characteristics - definitions**

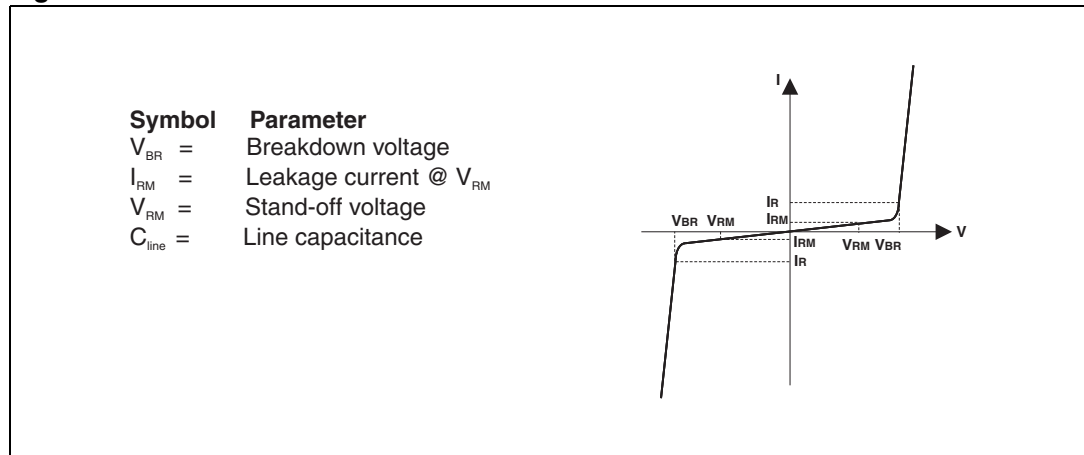

**Table 2. Electrical characteristics - values ( $T_{amb} = 25\text{ }^{\circ}\text{C}$ )**

Symbol	Test conditions	Min.	Typ.	Max.	Unit
$V_{BR}$	$I_R = 1\text{ mA}$	14			V
$I_{RM}$	$V_{RM} = 3\text{ V per line}$		50	200	nA
$R_1, R_3$	Tolerance $\pm 20\%$	80	100	120	$\Omega$
$R_2$	Tolerance $\pm 20\%$	37.6	47	56.4	$\Omega$
$C_{line}$	$V_{line} = 0\text{ V}, V_{osc} = 30\text{ mV}, F = 1\text{ MHz}$ (measured under zero light conditions)	8	10	12	pF

Figure 4. Attenuation measurement A2 - A3

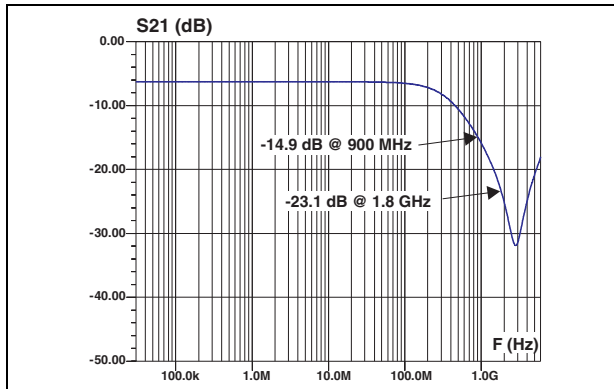

Figure 5. Attenuation measurement B1 - B3

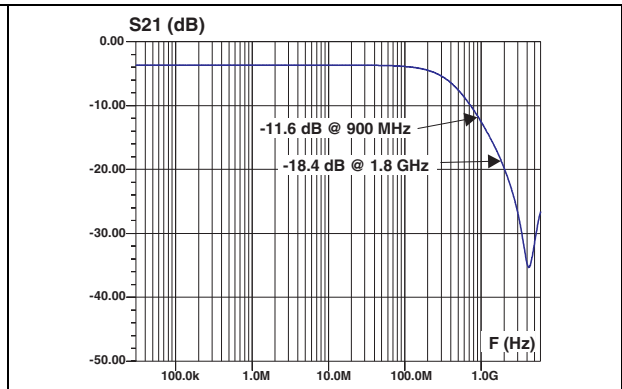

Figure 6. Attenuation measurement C1 - C3

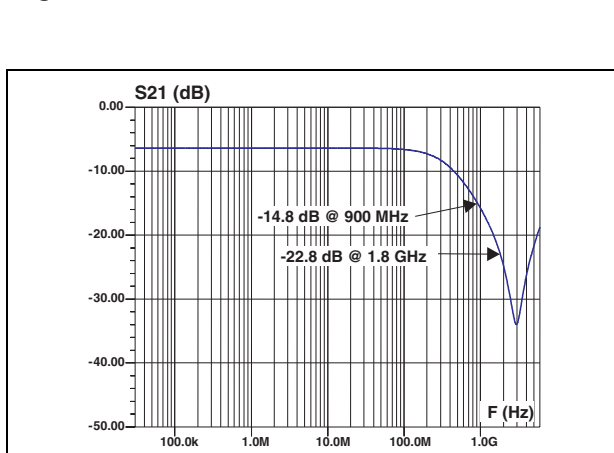

Figure 7. Analog crosstalk measurement A2 - B3 (30 kHz < F < 6 GHz > 11.8 dB)

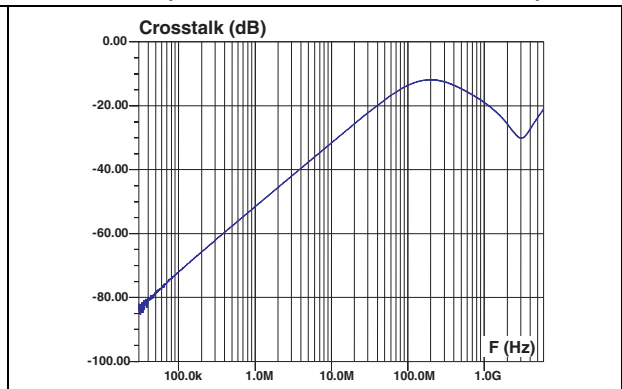

Figure 8. Analog crosstalk measurement A2 - C3 (30 kHz < F < 6 GHz > 13.8 dB)

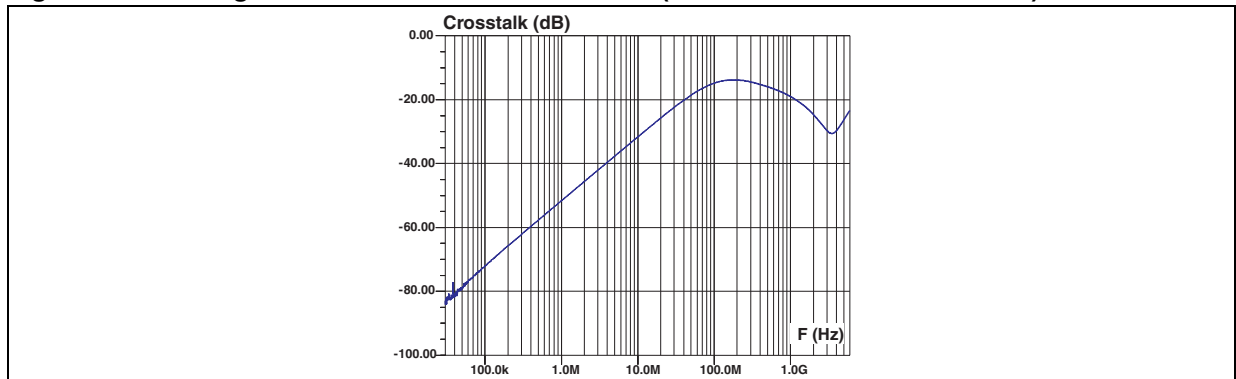

Figure 9. Digital crosstalk measurements

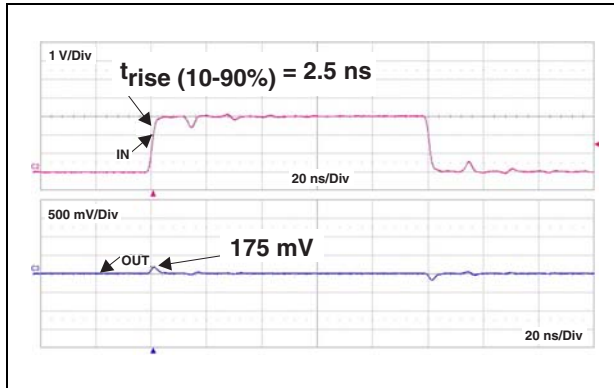

Figure 10. ESD response to IEC 61000-4-2 (+15 kV air discharge) on one line

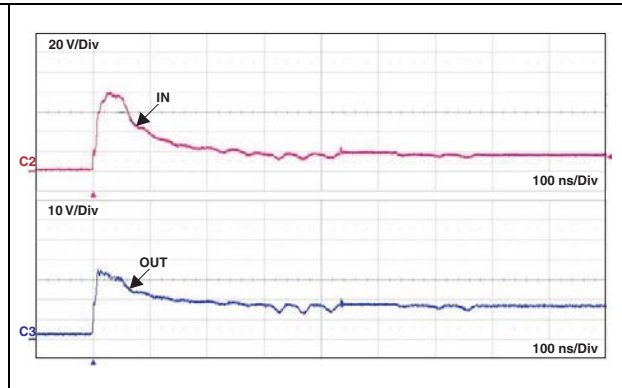

Figure 11. ESD response to IEC 61000-4-2 (-15 kV air discharge) on one line

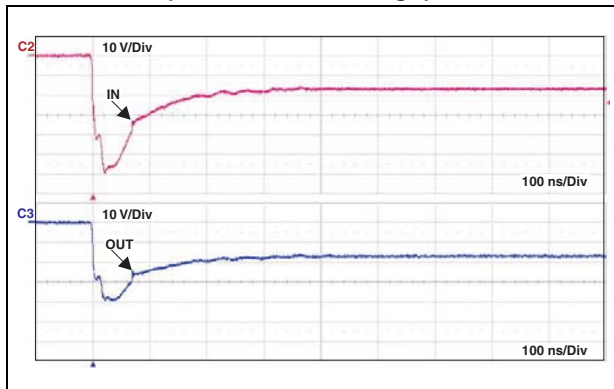
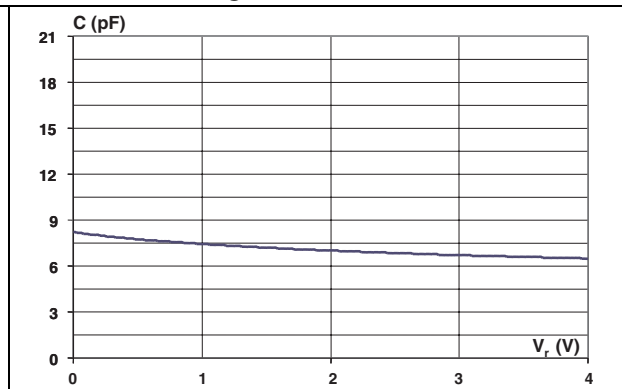
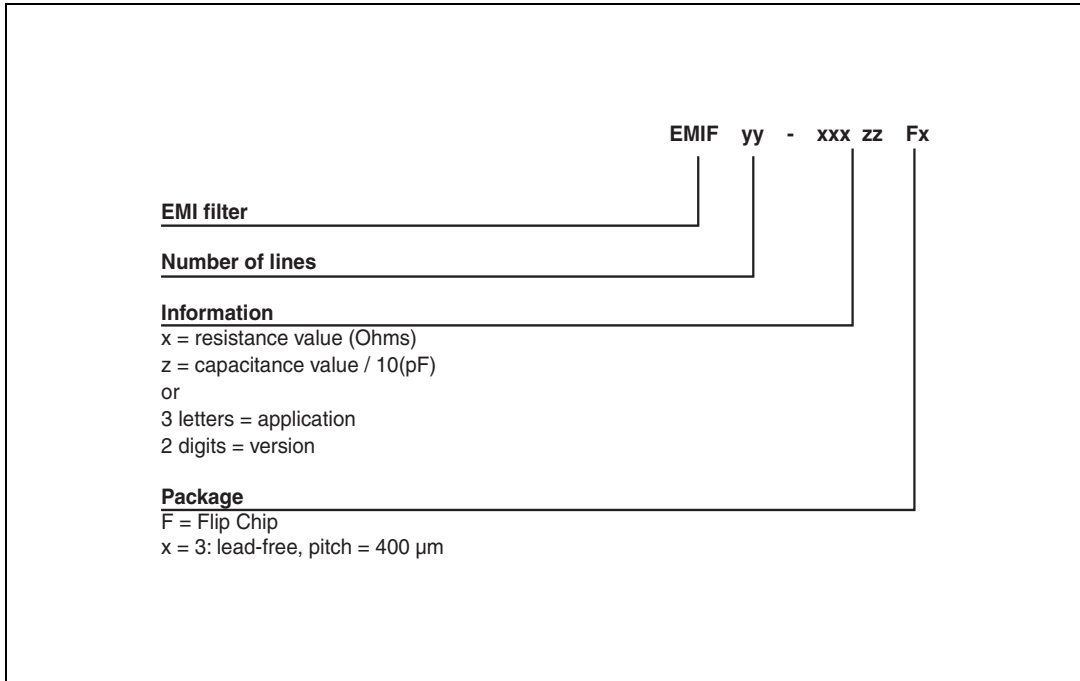

Figure 12. Line capacitance versus applied voltage



## 2 Ordering information scheme

Figure 13. Ordering information scheme



### 3 Package information

In order to meet environmental requirements, ST offers these devices in different grades of ECOPACK® packages, depending on their level of environmental compliance. ECOPACK® specifications, grade definitions and product status are available at: [www.st.com](http://www.st.com). ECOPACK® is an ST trademark.

Figure 14. Package dimensions

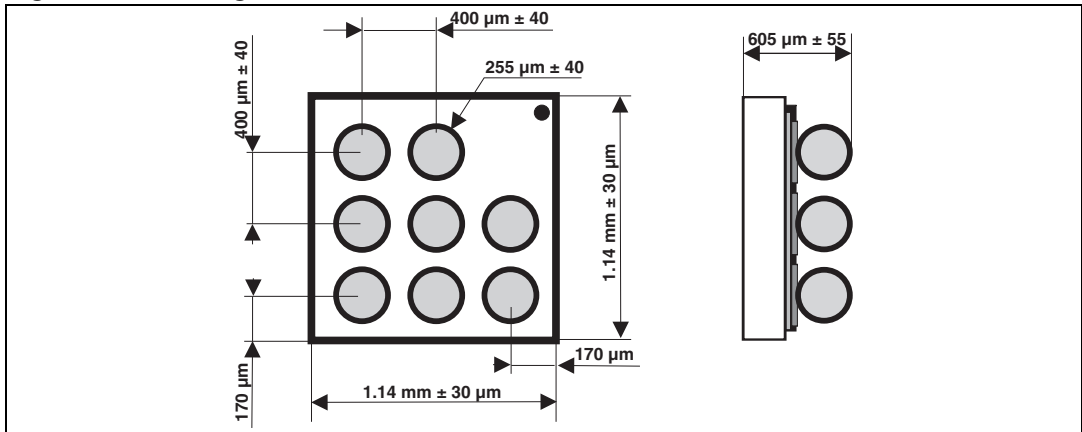

Figure 15. Footprint

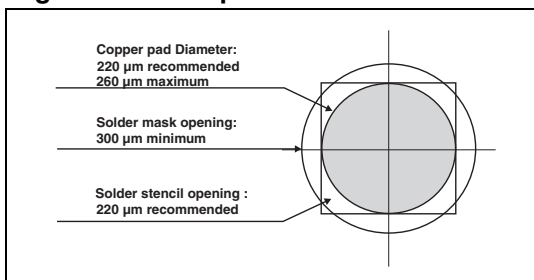

Figure 16. Marking

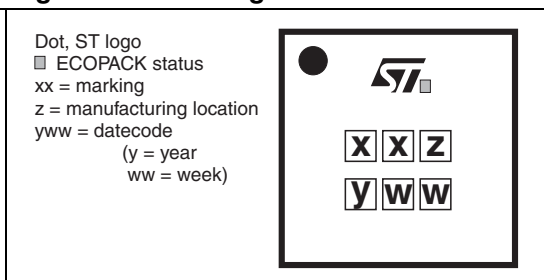
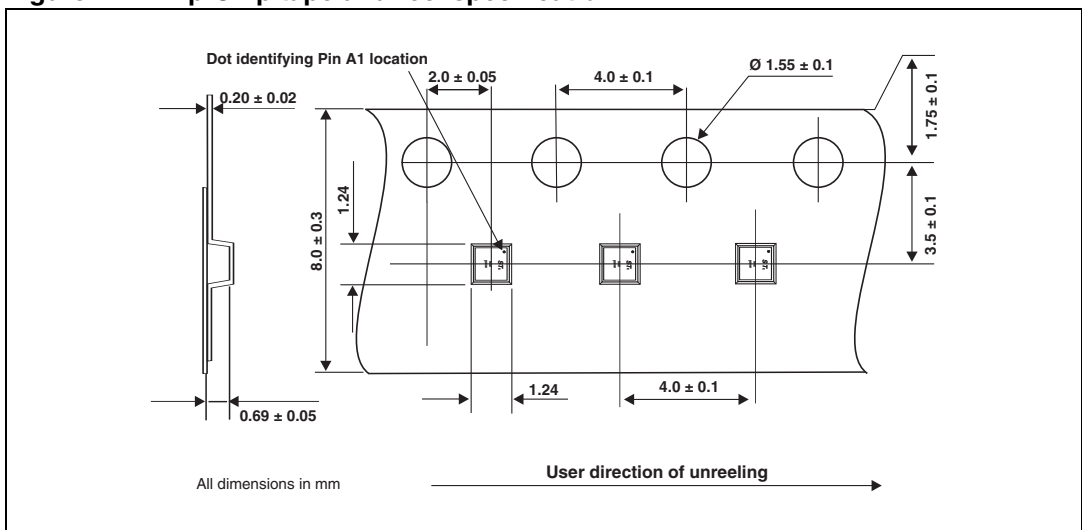

Figure 17. Flip-Chip tape and reel specification



## 4 Ordering information

**Table 3. Ordering information**

Order code	Marking	Package	Weight	Base qty	Delivery mode
EMIF03-SIM03F3	JH	Flip Chip	1.8 mg	5000	Tape and reel 7"

Note:

*More information is available in the application notes:*

*AN2348: "STMicroelectronics 400 micro-metre Flip Chip: package description and recommendation for use"*

*AN1751: "EMI filters: recommendations and measurements"*

## 5 Revision history

**Table 4. Document revision history**

Date	Revision	Changes
03-May-2010	1	Initial release.
12-Oct-2010	2	Updated <a href="#">Figure 2</a> and value $I_{RM}$ in <a href="#">Table 2</a> .

**Please Read Carefully:**

Information in this document is provided solely in connection with ST products. STMicroelectronics NV and its subsidiaries ("ST") reserve the right to make changes, corrections, modifications or improvements, to this document, and the products and services described herein at any time, without notice.

All ST products are sold pursuant to ST's terms and conditions of sale.

Purchasers are solely responsible for the choice, selection and use of the ST products and services described herein, and ST assumes no liability whatsoever relating to the choice, selection or use of the ST products and services described herein.

No license, express or implied, by estoppel or otherwise, to any intellectual property rights is granted under this document. If any part of this document refers to any third party products or services it shall not be deemed a license grant by ST for the use of such third party products or services, or any intellectual property contained therein or considered as a warranty covering the use in any manner whatsoever of such third party products or services or any intellectual property contained therein.

**UNLESS OTHERWISE SET FORTH IN ST'S TERMS AND CONDITIONS OF SALE ST DISCLAIMS ANY EXPRESS OR IMPLIED WARRANTY WITH RESPECT TO THE USE AND/OR SALE OF ST PRODUCTS INCLUDING WITHOUT LIMITATION IMPLIED WARRANTIES OF MERCHANTABILITY, FITNESS FOR A PARTICULAR PURPOSE (AND THEIR EQUIVALENTS UNDER THE LAWS OF ANY JURISDICTION), OR INFRINGEMENT OF ANY PATENT, COPYRIGHT OR OTHER INTELLECTUAL PROPERTY RIGHT.**

**UNLESS EXPRESSLY APPROVED IN WRITING BY AN AUTHORIZED ST REPRESENTATIVE, ST PRODUCTS ARE NOT RECOMMENDED, AUTHORIZED OR WARRANTED FOR USE IN MILITARY, AIR CRAFT, SPACE, LIFE SAVING, OR LIFE SUSTAINING APPLICATIONS, NOR IN PRODUCTS OR SYSTEMS WHERE FAILURE OR MALFUNCTION MAY RESULT IN PERSONAL INJURY, DEATH, OR SEVERE PROPERTY OR ENVIRONMENTAL DAMAGE. ST PRODUCTS WHICH ARE NOT SPECIFIED AS "AUTOMOTIVE GRADE" MAY ONLY BE USED IN AUTOMOTIVE APPLICATIONS AT USER'S OWN RISK.**

Resale of ST products with provisions different from the statements and/or technical features set forth in this document shall immediately void any warranty granted by ST for the ST product or service described herein and shall not create or extend in any manner whatsoever, any liability of ST.

ST and the ST logo are trademarks or registered trademarks of ST in various countries.

Information in this document supersedes and replaces all information previously supplied.

The ST logo is a registered trademark of STMicroelectronics. All other names are the property of their respective owners.

© 2010 STMicroelectronics - All rights reserved

STMicroelectronics group of companies

Australia - Belgium - Brazil - Canada - China - Czech Republic - Finland - France - Germany - Hong Kong - India - Israel - Italy - Japan - Malaysia - Malta - Morocco - Philippines - Singapore - Spain - Sweden - Switzerland - United Kingdom - United States of America

[www.st.com](http://www.st.com)