

FMMT619-G (NPN)

RoHS Device

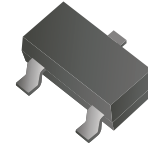

Features

-Low Saturation Voltage.

Diagram:

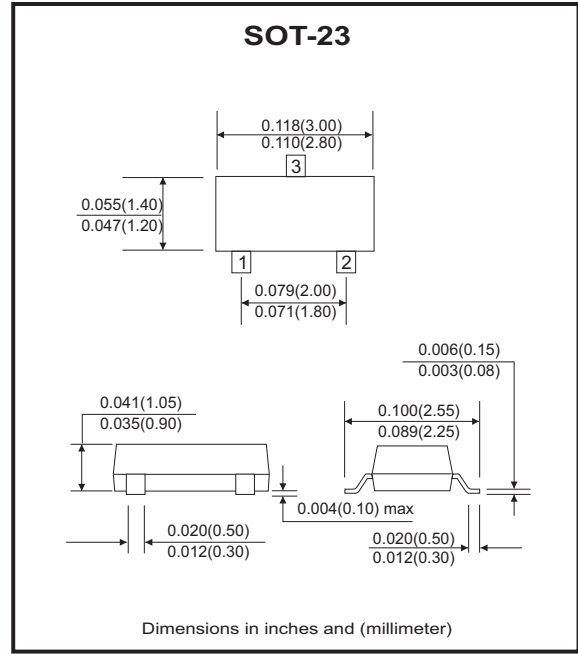
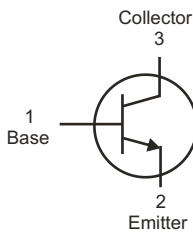

Maximum Ratings (at $T_A=25^{\circ}\text{C}$ unless otherwise noted)

Parameter	Symbol	Value	Units
Collector-Base voltage	V_{CB0}	50	V
Collector-Emitter voltage	V_{CEO}	50	V
Emitter-Base voltage	V_{EBO}	5.0	V
Collector current-continuous	I_C	2	A
Power dissipation	P_C	350	mW
Thermal resistance from junction to ambient	$R_{\theta JA}$	357	$^{\circ}\text{C}/\text{W}$
Maximum power dissipation (Note 1)	P_{CM}	625	mW
Thermal resistance from junction to ambient (Note 1)	$R_{\theta JA}$	200	$^{\circ}\text{C}/\text{W}$
Junction temperature	T_J	150	$^{\circ}\text{C}$
Storage temperature range	T_{STG}	-55 to +150	$^{\circ}\text{C}$

Notes:

1. Maximum power dissipation is calculated assuming that the device is mounted on a ceramic substrate measuring $15 \times 15 \times 0.6\text{mm}$.

Company reserves the right to improve product design, functions and reliability without notice.

REV: A

Electrical Characteristics (at $T_A=25^\circ\text{C}$ unless otherwise noted)

Parameter	Symbol	Conditions	Min.	Typ.	Max.	Units
Collector-Base breakdown voltage	$V_{(BR)CBO}$	$I_C=100\mu\text{A}$, $I_E=0$	50	-	-	V
Collector-Emitter breakdown voltage (Note 1)	$V_{(BR)CEO}$	$I_C=10\text{mA}$, $I_B=0$	50	-	-	V
Emitter-Base breakdown voltage	$V_{(BR)EBO}$	$I_E=100\mu\text{A}$, $I_C=0$	5	-	-	V
Collector cut-off current	I_{CBO}	$V_{CB}=40\text{V}$, $I_E=0$		-	100	nA
Emitter cut-off current	I_{EBO}	$V_{EB}=4\text{V}$, $I_C=0$	-	-	100	nA
DC current gain (Note 1)	$h_{FE(1)}$	$V_{CE}=2\text{V}$, $I_C=10\text{mA}$	200	-	-	
	$h_{FE(2)}$	$V_{CE}=2\text{V}$, $I_C=0.2\text{A}$	300	-	-	
	$h_{FE(3)}$	$V_{CE}=2\text{V}$, $I_C=1\text{A}$	200	-	-	
	$h_{FE(4)}$	$V_{CE}=2\text{V}$, $I_C=2\text{A}$	100	-	-	
	$h_{FE(5)}$	$V_{CE}=2\text{V}$, $I_C=6\text{A}$	-	40	-	
Collector-Emitter saturation voltage (Note 1)	$V_{CE(sat)1}$	$I_C=0.1\text{A}$, $I_B=10\text{mA}$	-	-	20	mV
	$V_{CE(sat)2}$	$I_C=1\text{A}$, $I_B=10\text{mA}$	-	-	200	mV
	$V_{CE(sat)3}$	$I_C=2\text{A}$, $I_B=100\text{mA}$	-	-	220	mV
Base-Emitter saturation voltage (Note 1)	$V_{BE(sat)}$	$I_C=2\text{A}$, $I_B=50\text{mA}$	-	-	1	V
Base-Emitter on voltage (Note 1)	$V_{BE(on)}$	$I_C=2\text{A}$, $V_{CE}=2\text{V}$	-	-	1	V
Output capacitance	C_{ob}	$V_{CB}=10\text{V}$, $f=1\text{MHz}$	-	-	20	pF
Turn-on time	$t_{(on)}$	$V_{CC}=10\text{V}$, $I_C=1\text{A}$ $I_{B1}=-I_{B2}=10\text{mA}$	-	170	-	nS
Turn-off time	$t_{(off)}$		-	750	-	nS
Transition frequency	f_T	$V_{CE}=10\text{V}$, $I_C=50\text{mA}$ $f=100\text{MHz}$	100	-	-	MHz

Notes:

1. Pulse test: Pulse Width $\leq 300\mu\text{s}$, Duty Cycle $\leq 2.0\%$.

RATING AND CHARACTERISTIC CURVES (FMMT619-G)

Fig.1 - Static Characteristic

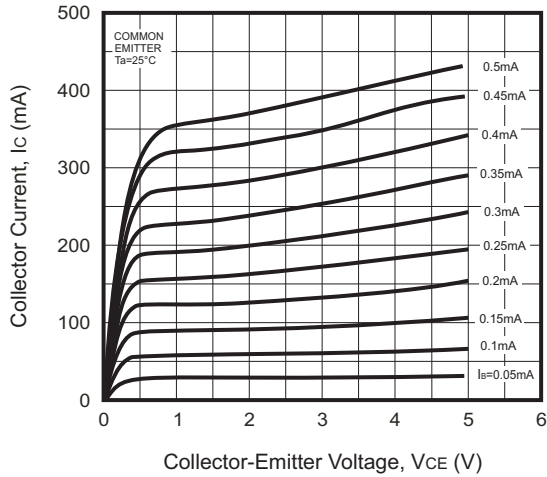

Fig.2 - $h_{FE} - I_c$

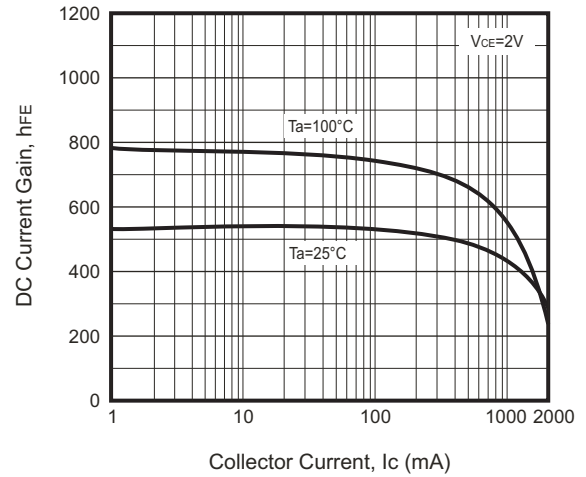

Fig.3 - $V_{BEsat} - I_c$

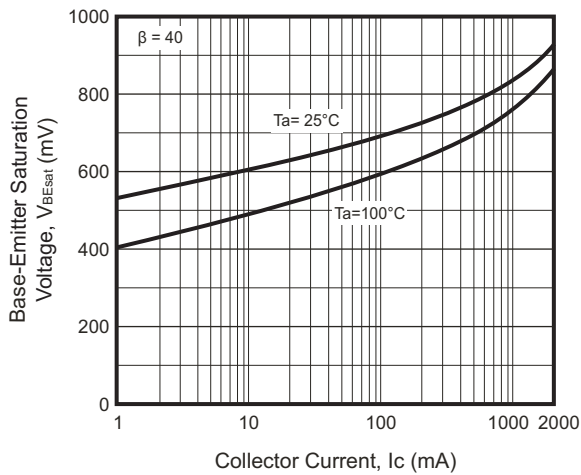

Fig.4 - $V_{CEsat} - I_c$

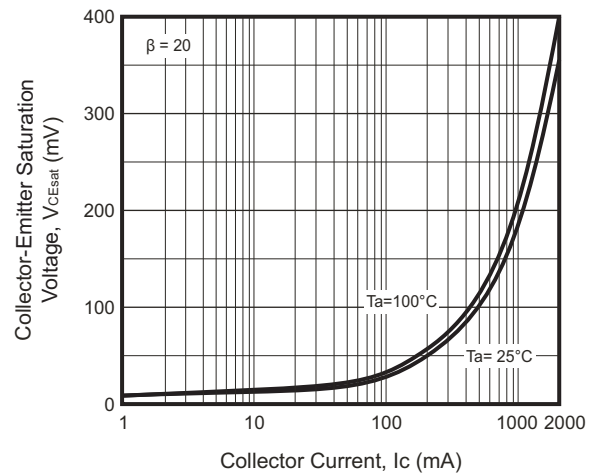

Fig.5 - $f_T - I_c$

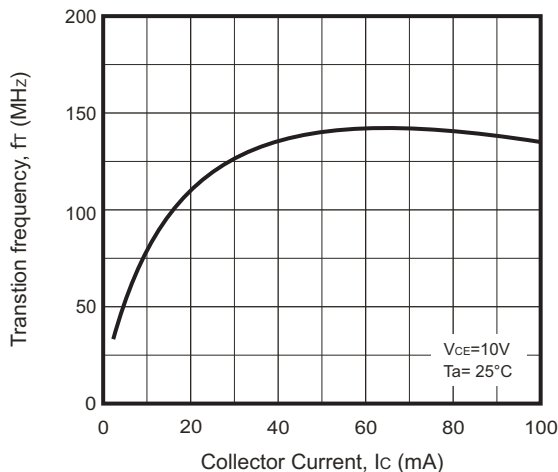
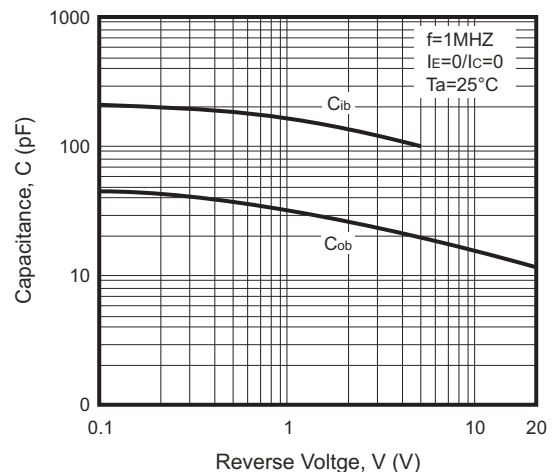

Fig.6 - $C_{ob}/C_{ib} - V_{CB}/V_{EB}$



Company reserves the right to improve product design, functions and reliability without notice.

REV: A

RATING AND CHARACTERISTIC CURVES (FMMT619-G)

Fig.7 - $V_{BE} - I_c$

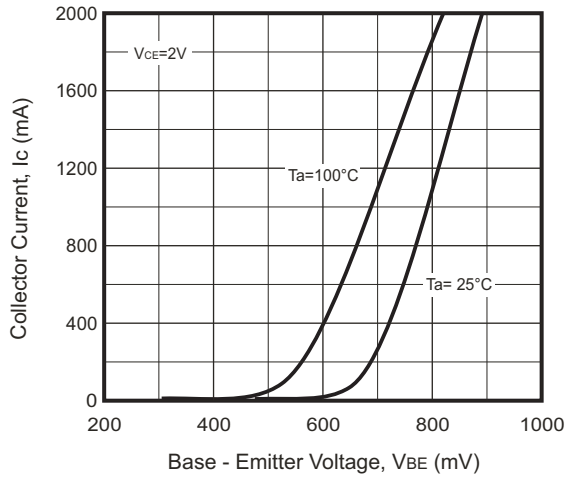
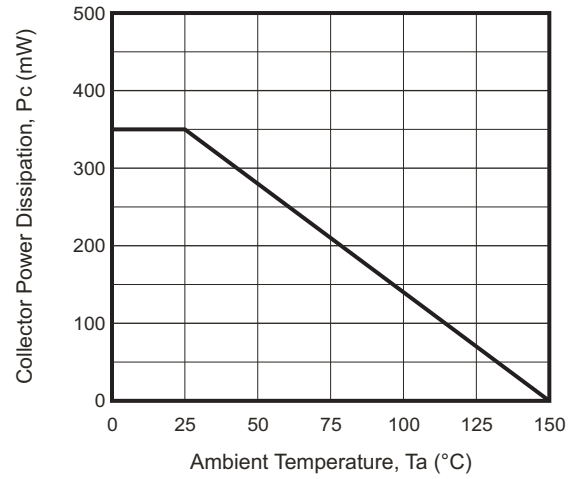
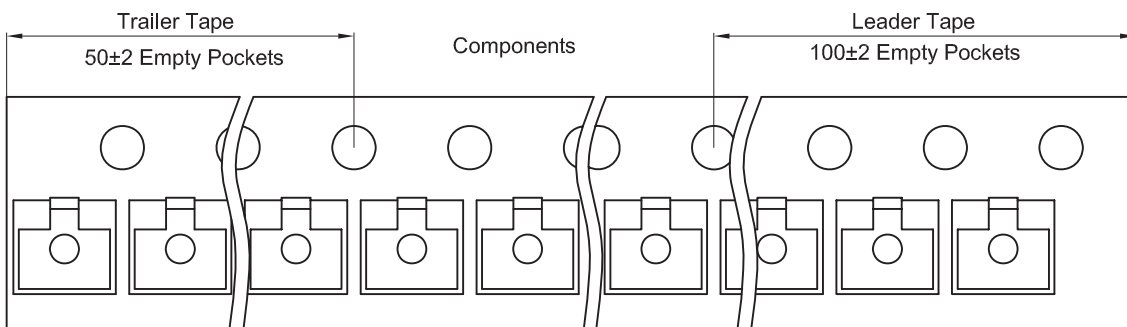
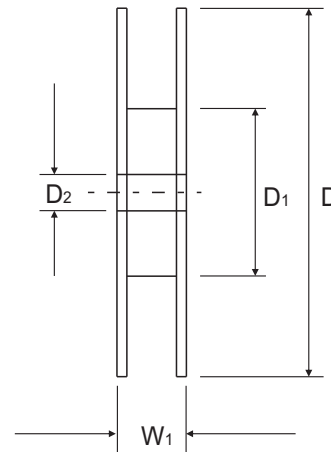
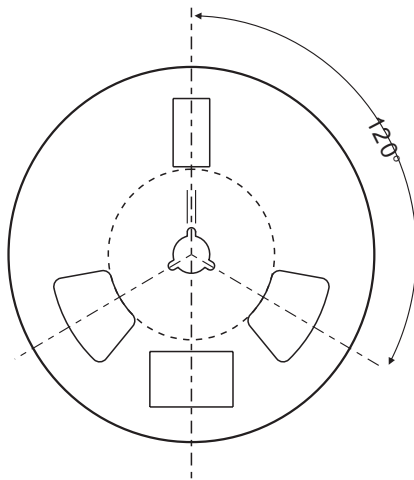
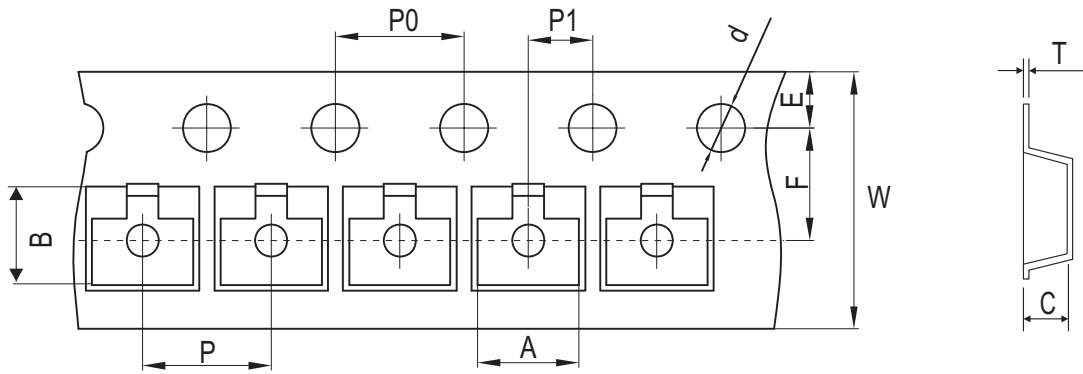

Fig.8 - $P_c - T_a$



Reel Taping Specification



SOT-23	SYMBOL	A	B	C	d	D	D1	D2
	(mm)	3.15 ± 0.10	2.77 ± 0.10	1.22 ± 0.10	1.50 ± 0.10	178.00 ± 2.00	54.40 ± 1.00	13.00 ± 1.00
	(inch)	0.124 ± 0.004	0.109 ± 0.004	0.048 ± 0.004	0.059 ± 0.004	7.087 ± 0.079	2.142 ± 0.039	0.512 ± 0.039

SOT-23	SYMBOL	E	F	P	P0	P1	W	W1
	(mm)	1.75 ± 0.10	3.50 ± 0.10	4.00 ± 0.10	4.00 ± 0.10	2.00 ± 0.10	8.00 + 0.30 / - 0.10	12.30 ± 1.00
	(inch)	0.069 ± 0.004	0.138 ± 0.004	0.157 ± 0.004	0.157 ± 0.004	0.079 ± 0.004	0.315 + 0.012 / - 0.004	0.484 ± 0.039

Company reserves the right to improve product design, functions and reliability without notice.

REV: A

Marking Code

Part Number	Marking Code
FMMT619-G	619

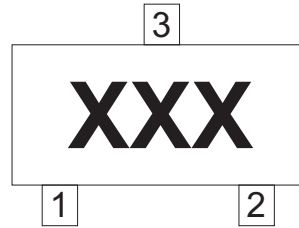

xx = Product type marking code

Suggested PAD Layout

SIZE	SOT-23	
	(mm)	(inch)
A	0.80	0.031
B	0.60	0.024
C	1.90	0.075
D	2.02	0.080

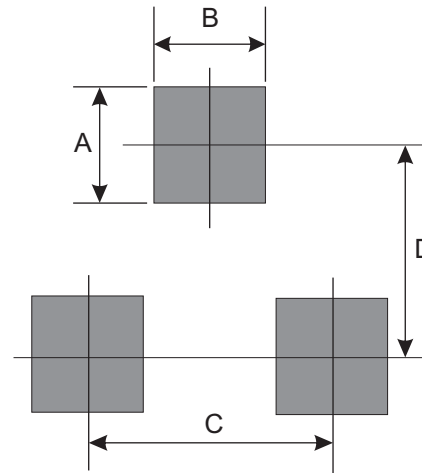

Note:

1. General tolerance: $\pm 0.05\text{mm}$.
2. The pad layout is for reference purposes only.

Standard Packaging

Case Type	REEL PACK	
	REEL (pcs)	Reel Size (inch)
SOT-23	3,000	7