

Bourns® Rectifier Diodes

Short Form Brochure

Bridge Rectifier Diodes • Schottky Bridge Rectifier Diodes • Fast Response Rectifier Diodes • Standard Rectifier Diodes • Schottky Rectifier Diodes



BOURNS®

Introduction

Bourns® Rectifier Diodes

A rectifier is an electrical device used to convert alternating current (AC) which periodically reverses direction, to direct current (DC) which flows in only one direction. Bourns offers a wide variety of rectifier products including bridge rectifiers and discrete rectifiers. Bourns® bridge rectifiers perform with higher forward current and low forward voltages for use in low voltage and high efficiency designs. Fast response rectifier diodes support fast reverse recovery time with high forward current capability for high speed switched-mode power supply applications. Standard rectifier diodes provide high forward current capability with low reverse leakage current, and Schottky rectifier diodes can perform with high forward current and low forward voltage for low heat dissipation. AC to DC and DC to DC converters are common applications of rectifier diodes.

Bourns® Rectifier Diode Product Offering

- Bridge Rectifier Diodes
- Schottky Bridge Rectifier Diodes
- Fast Response Rectifier Diodes
- Standard Rectifier Diodes
- Schottky Rectifier Diodes

AC to DC Converter

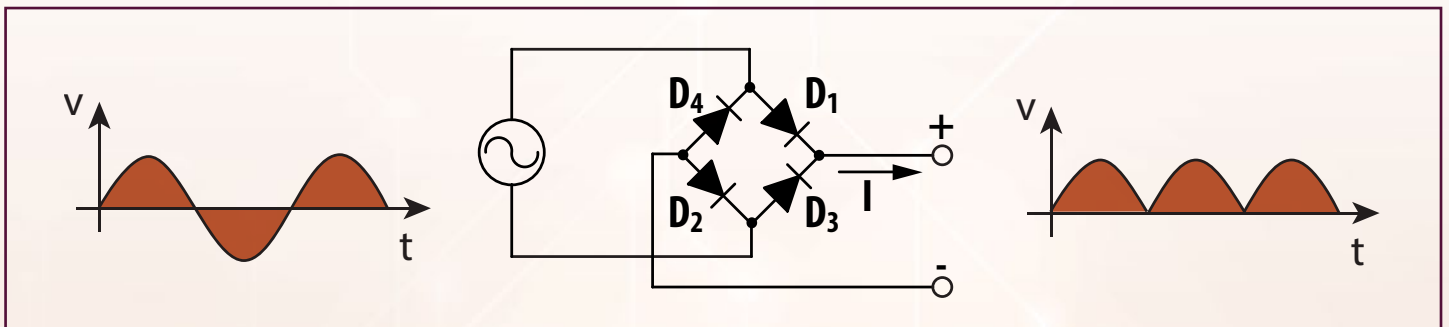

A bridge rectifier diode or four discrete rectifier diodes connected in a closed loop “bridge” configuration provide full-wave rectification from AC input into a DC output. The bridge rectifier diode blocks the current in the reverse direction and allows the current in the forward direction to keep the output current in one direction. During the positive

half cycle of the supply, diodes D_1 and D_2 conduct in series while diodes D_3 and D_4 are reverse biased and the current flows through the load. During the negative half cycle of the supply, diodes D_3 and D_4 conduct in series, but diodes D_1 and D_2 switch “OFF” which are reverse biased. The current flowing through the load.

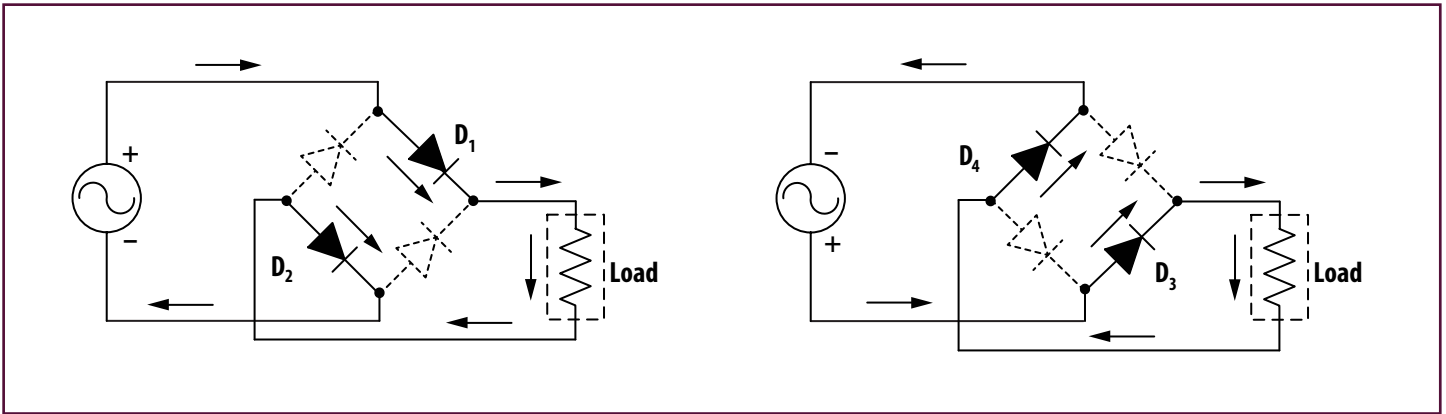

DC to DC Converter

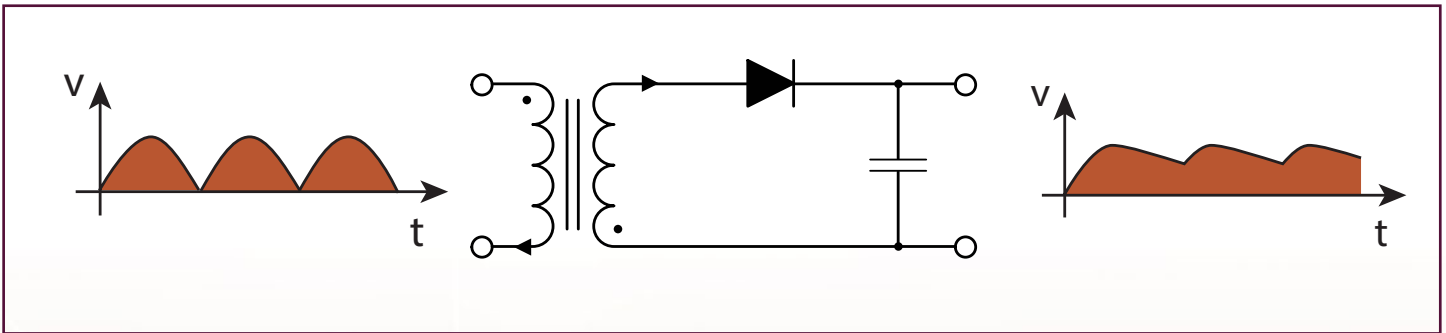

Switched-mode DC to DC converters transform one DC voltage level to another, which may be higher (boost) or lower (buck), by storing the input energy temporarily and then releasing that energy to the output at a different voltage. When the switch is in the on-state, the rectifier diode blocks the reverse current and the

energy is transferred from the input voltage source to the transformer and the output capacitor supplies energy to the output load. When the switch is in the off-state, the energy is transferred from the transformer to the output load and the output capacitor.

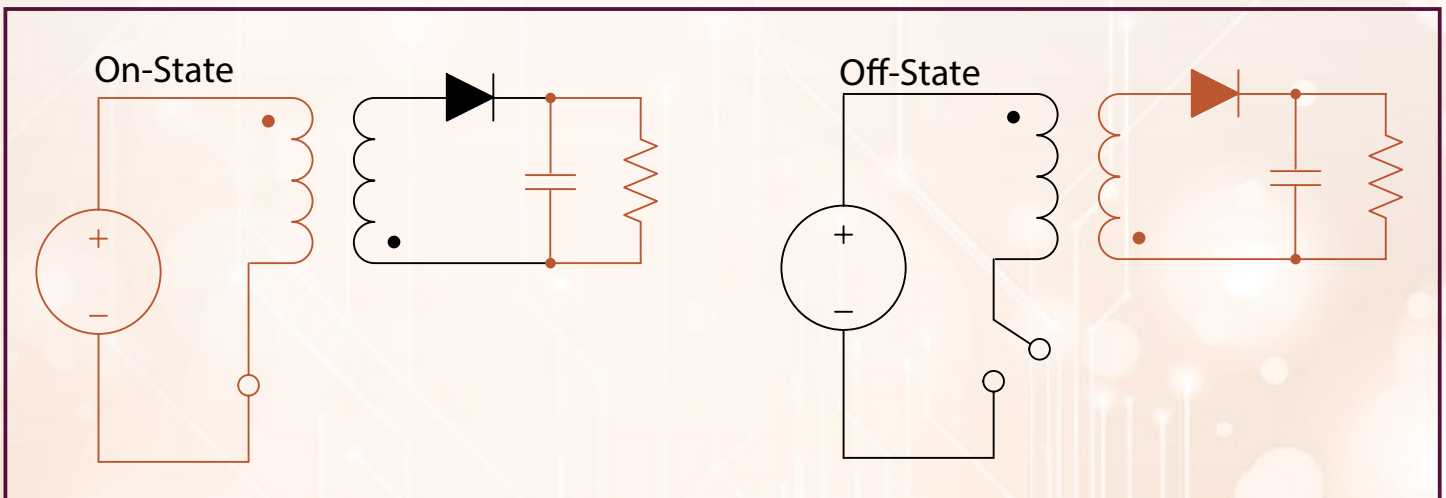

Product Selection

General Rectifier Diode Parameters

Maximum Repetitive Peak Reverse Voltage (V_{RRM}) is the maximum voltage a rectifier diode can withstand in the reverse direction without breaking down or avalanching, and rectifier diodes must have a peak inverse voltage rating higher than the maximum voltage being applied to them in the application.

Maximum Average Forward Rectified Current (I_F) is the maximum allowable average forward current in the normal operating temperature range.

Maximum Peak Forward Surge Current (I_{FSM}) is the maximum allowable non-repetitive half-sine wave surge current with a pulse width of 8.3 milliseconds.

Forward Voltage (V_F) is the rectifier diode's forward voltage and low V_F rectifier diodes have less power dissipation in the forward direction to save energy.

Reverse Leakage Current (I_R) is the diode's reverse leakage current, and low I_R rectifier diodes have less power dissipation in the reverse direction for power reduction.

Junction Capacitance (C_J) is the junction capacitance, and Reverse Recovery Time (T_{rr}) is the turn-off delay from the forward direction to the reverse direction. Low junction capacitance and fast reverse recovery time rectifier diodes are used for high-speed switching converter applications.

Thermal Resistance to Air ($R_{\theta JA}$) is the resistance to heat flow. Low thermal resistance rectifier diodes generate less heat, making them a good quality insulator.

Symbol	Parameter	Unit	Description
V_{RRM}	Maximum Repetitive Peak Reverse Voltage	V	Maximum allowable repetitive instantaneous value of the diode's reverse voltage
I_F	Maximum Average Forward Rectified Current	A	Maximum allowable average forward current
I_{FSM}	Maximum Peak Forward Surge Current	A	Maximum allowable non-repetitive half-sine wave surge current
V_F	Forward Voltage	V	Voltage of the diode at I_F
I_R	Reverse Leakage Current	μA	Reverse leakage current at V_{RRM}
C_J	Junction Capacitance	pF	Junction capacitance of the diode
T_{rr}	Reverse Recovery Time	ns	Duration of time for diode to "turn off" when alternating current is from forward-bias to reverse-bias polarity
$R_{\theta JA}$	Thermal Resistance to Air	$^{\circ}C/W$	Temperature difference between junction and outside air per watt

Bridge Rectifier Selection

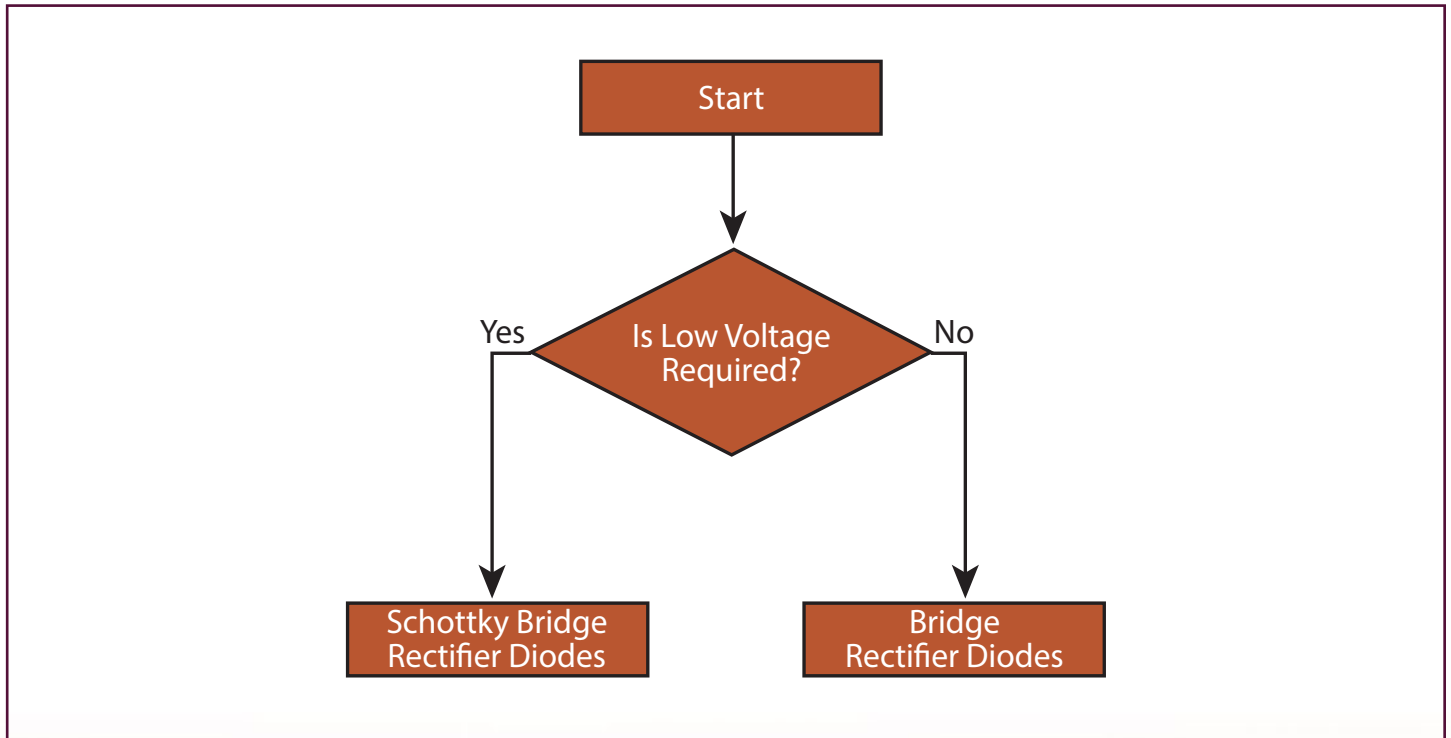

Discrete Rectifier Selection

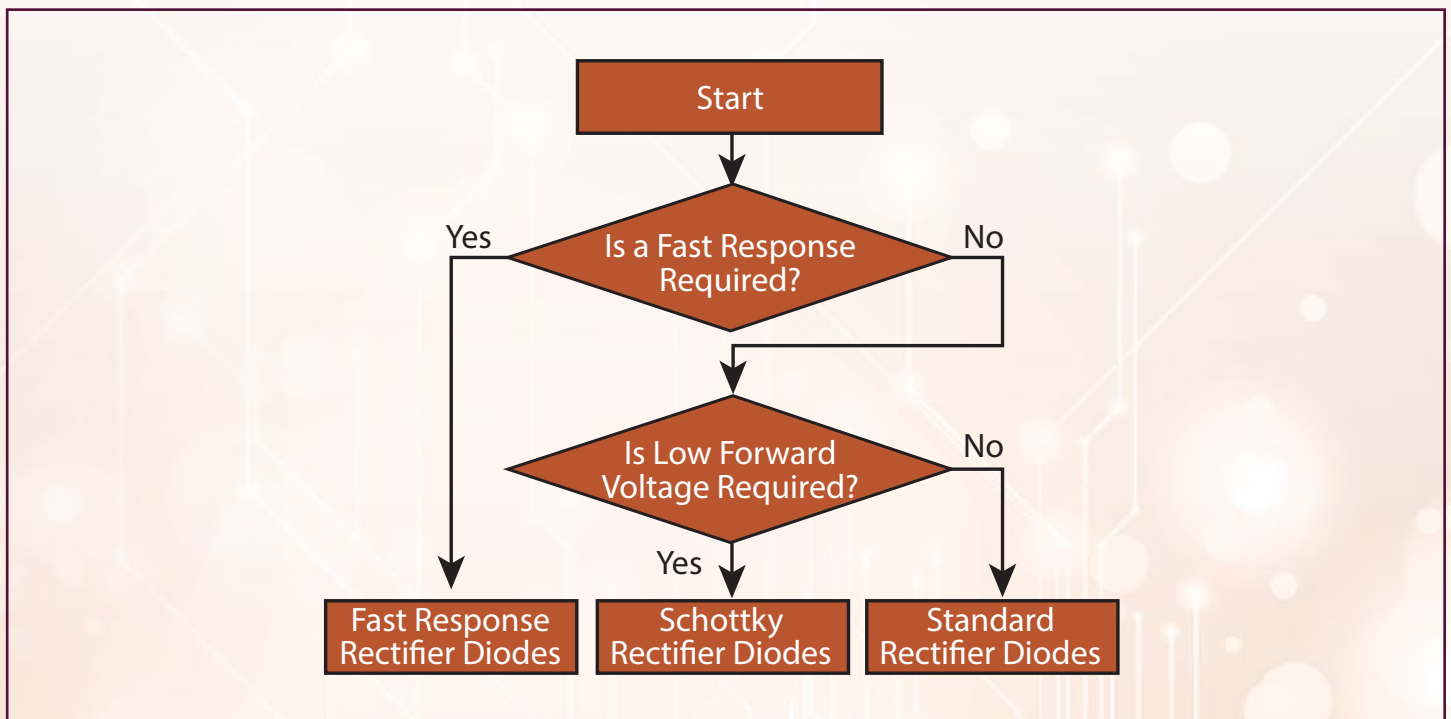

Rectifier Diode Applications

Flyback Converter Topology

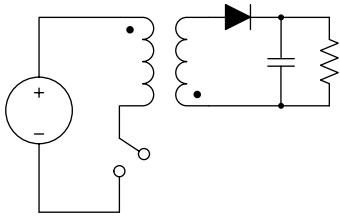

Isolation	Yes
Max. Power (W)	100
Strengths	Ground referenced switch, multiple outputs, fewer components
Weaknesses	Limited to 10 A output, high stress on diode, inefficient (use of ZVS converters improves losses)
Applications	AC/DC and DC/DC appliances, solar inverters, LED lighting, AC adaptors, E-meters, battery chargers, automotive, circuit breakers, TVs, STBs, PoE

Forward Topology

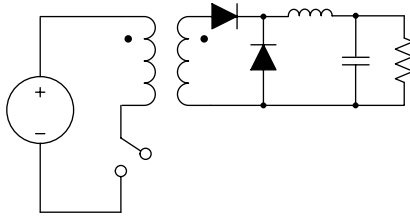

Isolation	Yes
Max. Power (W)	200
Strengths	Large step-down ratio
Weaknesses	High voltage on-switch increases power lost
Applications	AC/DC, DC/DC industrial controls

Two-Switch Forward Topology

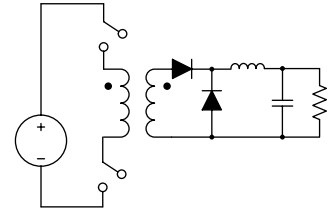

Isolation	Yes
Max. Power (W)	1000
Strengths	Very rugged circuit
Weaknesses	Noisy input
Applications	AC/DC, DC/DC industrial controls

Half Bridge Forward Topology

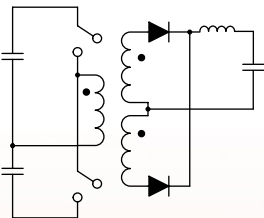

Isolation	Yes
Max. Power (W)	500
Strengths	Reduced core loss
Weaknesses	Does not work well with current mode, making it less than ideal for off-line power supplies
Applications	DC/DC industrial controls, telecom, data processing

Full Bridge Forward Topology

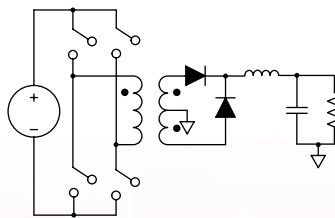

Isolation	Yes
Max. Power (W)	5000
Strengths	Clamped primary switch and minimal switching losses
Weaknesses	Requires experience to get functioning properly
Applications	AC/DC and DC/DC industrial controls, telecom, data processing, automotive HEV / EV

Full Bridge Resonant Topology

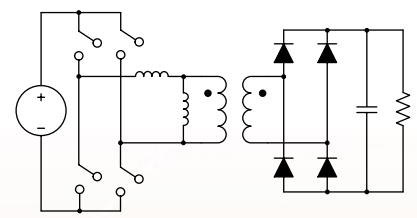

Isolation	Yes
Max. Power (W)	5000
Strengths	Soft switching
Weaknesses	Narrow input range
Applications	Lighting

Push Pull Converter Topology

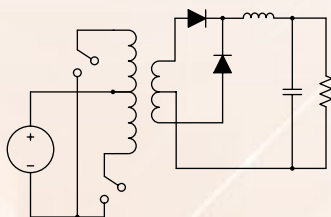

Isolation	Yes
Max. Power (W)	500
Strengths	Ground referenced switches
Weaknesses	Limited to low input voltages
Applications	DC/DC battery chargers, servers

Boost Converter Topology

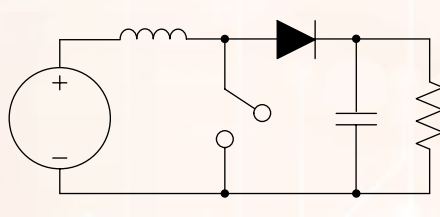

Isolation	No
Max. Power (W)	1000
Strengths	Low noise input
Weaknesses	Requires current mode control and has no isolation
Applications	AC/DC and DC/DC power factor correction circuits, automotive electric vehicles, motor drives (appliances)

Buck Converter Topology

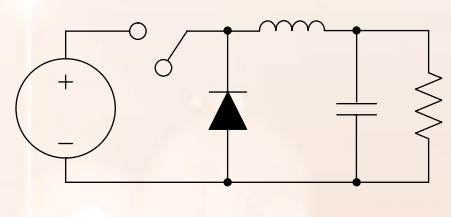

Isolation	No
Max. Power (W)	1000
Strengths	Low noise output
Weaknesses	Optimum input/output ratio must be less than 10; no isolation
Applications	AC/DC and DC/DC notebooks, servers, graphic processors, automotive

Bridge Rectifier Diodes



Features

High current capability
Low profile package

Applications

Switch Mode Power Supplies (SMPS)
Power Supplies

Part Number	V_{RRM} (V)	I_F (A)	I_{FSM} (A)	$V_F @ I_F$ (V)	I_R (μ A)	Capacitance (pF)	Compliant Package	Length (mm)	Width (mm)	$R_{\theta JA}$ ($^{\circ}$ C/W)
CD-DF410SL	1000	4	150	0.9	5	45	DFS-4	10.6	8.2	35
CD-DF408SL	800									
CD-DF406SL	600									
CD-DF410S	1000			0.95						
CD-DF408S	800									
CD-DF406S	600									
CD-MBL210SL	1000	2	60	0.96	5	35	2320	5.9	5.4	95
CD-MBL208SL	800									
CD-MBL206SL	600									
CD-MBL210S	1000			1						
CD-MBL208S	800									
CD-MBL206S	600									
CD-MBL110SL	1000	1	45	0.95	5	25	2320	5.9	5.4	95
CD-MBL108SL	800									
CD-MBL106SL	600									
CD-MBL110S	1000			1						
CD-MBL108S	800									
CD-MBL106S	600									
CD-MBL104S	400	0.8	30	1	5	26	NBS04	7	4.9	50
CD-MBL102S	200									
CDNBS04-B08800	800									
CDNBS04-B08600	600									
CDNBS04-B08400	400									
CDNBS04-B08200	200									

Schottky Bridge Rectifier Diodes

Features

- High current capability
- Low forward voltage
- Low profile package

Applications

- Switch Mode Power Supplies (SMPS)
- Power Supplies

Part Number	V_{RRM} (V)	I_F (A)	I_{FSM} (A)	$V_F @ I_F$ (V)	I_R (μ A)	Capacitance (pF)	Compliant Package	Length (mm)	Width (mm)	$R_{\theta JA}$ ($^{\circ}$ C/W)
CD-HD201L	100	2	60	0.8	100	250	TO-269AA	6.25	4.85	145
CD-HD2006L	60		50	0.55						
CD-HD2004	40		50	0.5						
CD-HD201	100	1	30	0.85	200	250	TO-269AA	6.25	4.85	110
CD-HD2006	60			0.7						
CD-HD01	100			0.85						
CD-HD006	60	1	30	0.7	200	250	TO-269AA	6.25	4.85	110
CD-HD004	40			0.5						

Schottky Rectifier Diodes



Part Number	V _{RRM} (V)	I _F (A)	I _{FSM} (A)	V _F @ I _F (V)	I _R (μA)	Capacitance (pF)	Compliant Package	Length (mm)	Width (mm)	R _{θJA} (°C/W)
CD214C-B360LF	60			0.7						
CD214C-B350LF	50			0.7						
CD214C-B340LF	40	3	100	0.5	500	250	DO-214AB/SMC	6.9	5.9	60
CD214C-B330LF	30			0.5						
CD214C-B320LF	20			0.5						
CD214B-B360LF	60			0.7						
CD214B-B350LF	50			0.7						
CD214B-B340LF	40	3	100	0.5	500	250	DO-214AA/SMB	4.3	3.6	95
CD214B-B330LF	30			0.5						
CD214B-B320LF	20			0.5						
CD214A-B360LF	60			0.7						
CD214A-B350LF	50		100	0.7						
CD214A-B340LF	40	3		0.5	500	250	DO-214AC/SMA	4.3	2.6	100
CD214A-B340LLF	40		70	0.45						
CD214A-B330LF	30		100	0.5						
CD214A-B320LF	20			0.5						
CD214B-B260LF	60			0.7	500					60
CD214B-B250LF	50			0.7						
CD214B-B240LF	40	2	50	0.5	500	200	DO-214AA/SMB	4.3	3.6	
CD214B-B230LF	30			0.5	500					50
CD214B-B220LF	20			0.5	500					
CD214A-B260LF	60			0.7	500					65
CD214A-B250LF	50			0.7	500					
CD214A-B240LF	40	2	50	0.5	500	200	DO-214AC/SMA	4.3	2.6	70
CD214A-B240LLF	40			0.43	200					
CD214A-B230LF	30			0.5	500					65
CD214A-B220LF	20			0.5	500					
CD1206-B2100	100			0.85	500					
CD1206-B260	60	2	40	0.7	500	200	SOD-87/SOD-123	3.4	1.9	75
CD1206-B240	40			0.5	500					
CD1206-B220	20			0.5	500					
CD214B-B160LF	60			0.7	500					
CD214B-B150LF	50			0.7	500					
CD214B-B140LF	40		30	0.5	500	110	DO-214AA/SMB	4.3	3.6	22
CD214B-B130LF	30			0.5	500					
CD214B-B120LF	20			0.5	500					
CD214A-B1100LF	100			0.79	500					
CD214A-B190LF	90			0.79	500	30				50
CD214A-B180LF	80			0.79	500					
CD214A-B170LF	70	1		0.79	500					
CD214A-B160LF	60		30	0.7	500	110				65
CD214A-B150LF	50			0.7	500	100	DO-214AC/SMA	4.3	2.6	
CD214A-B140LF	40			0.5	500	110				
CD214A-B130LF	30			0.5	500	110				
CD214A-B130LLF	30		25	0.41	1000	100				70
CD214A-B120LF	20		30	0.5	500	110				
CD214A-B120LLF	20		25	0.41	1000	100				
CD2010-B160	60	1	50	0.52	500	300	SOD-106	4.5	2.2	75
CD2010-B140	40		70	0.45	100	300				
CD216A-B140LF	40		40	0.55	500	60				
CD216A-B130LLF	30	1		0.38	410	70				
CD216A-B120LLF	20		50	0.45	400	90	DO-216AA	3.95	2.05	250
CD216A-B120RLF	20			0.53	10	75				
CD123D-B120R	20			0.46	15					
CD123D-B140R	40	1	20	0.46	15	110	SOD-123	3.4	1.9	190
CD123D-B140LR	40			0.37	300	115				
CD0603-B0240R	40	0.2		0.43	0.5					
CD0603-B0340R	40	0.3	2	0.47	3	35	0603 (1608 metric)	1.6	0.9	160

Worldwide Sales Offices

Country/Region	Phone	Email
Americas:	+1-951-781-5500	americus@bourns.com
Brazil:	+55 11 5505 0601	americus@bourns.com
China:	+86 21 64821250	asiacus@bourns.com
Europe, Middle East, Africa:	+36 88 520 390	eurocus@bourns.com
Japan:	+81 49 269 3204	asiacus@bourns.com
Korea:	+82 70 4036 7730	asiacus@bourns.com
Singapore:	+65 6348 7227	asiacus@bourns.com
Taiwan:	+886 2 25624117	asiacus@bourns.com
Other Asia-Pacific Countries:	+886 2 25624117	asiacus@bourns.com

Technical Assistance Region	Phone	Email
Asia-Pacific:	+886 2 25624117	techweb@bourns.com
Europe, Middle East, Africa:	+36 88 520 390	eurotech@bourns.com
Americas:	+1-951-781-5500	techweb@bourns.com

www.bourns.com

Bourns® products are available through an extensive network of manufacturer's representatives, agents and distributors. To obtain technical applications assistance, a quotation, or to place an order, contact a Bourns representative in your area.

Specifications subject to change without notice. Actual performance in specific customer applications may differ due to the influence of other variables. Customers should verify actual device performance in their specific applications.

BOURNS®

"Bourns" is a registered trademark of Bourns, Inc. in the U.S. and other countries.

COPYRIGHT© 2017, BOURNS, INC. • LITHO IN U.S.A. • 10/17 • e/ESD1719