



## GaAs InGaP HBT MMIC POWER AMPLIFIER, 5 - 7 GHz

### Typical Applications

This amplifier is ideal for use as a power amplifier for 5 - 7 GHz applications:

- UNII
- HiperLAN

### Features

- Gain: 15 dB
- Saturated Power: +29 dBm
- 28% PAE
- Supply Voltage: +5V
- Power Down Capability
- No External Matching Required

### Functional Diagram

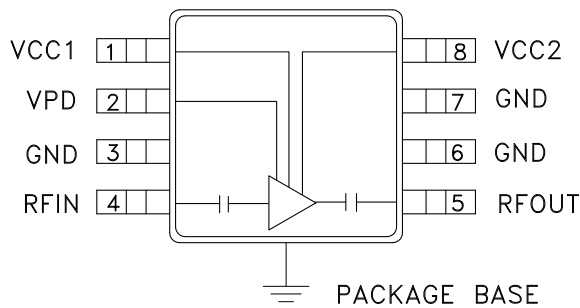

### General Description

The HMC407MS8G & HMC407MS8GE are high efficiency GaAs InGaP Heterojunction Bipolar Transistor (HBT) MMIC Power amplifiers which operate between 5 and 7 GHz. The amplifier requires no external matching to achieve operation and is thus truly 50 Ohm matched at input and output. The amplifier is packaged in a low cost, surface mount 8 leaded package with an exposed base for improved RF and thermal performance. The amplifier provides 15 dB of gain, +29 dBm of saturated power at 28% PAE from a +5V supply voltage. Power down capability is available to conserve current consumption when the amplifier is not in use.

### Electrical Specifications, $T_A = +25^\circ C$ , $V_s = 5V$ , $V_{pd} = 5V$

Parameter	Min.	Typ.	Max.	Min.	Typ.	Max.	Units
Frequency Range	5 - 7			5.6 - 6.0			GHz
Gain	10	15	18	12	15	18	dB
Gain Variation Over Temperature		0.025	0.035		0.025	0.035	dB/ °C
Input Return Loss		12			12		dB
Output Return Loss		15			15		dB
Output Power for 1 dB Compression (P1dB)	21	25		22	25		dBm
Saturated Output Power (P <sub>sat</sub> )		29			29		dBm
Output Third Order Intercept (IP <sub>3</sub> )	32	37		36	40		dBm
Noise Figure		5.5			5.5		dB
Supply Current (I <sub>cq</sub> )	V <sub>pd</sub> = 0V/5V		0.002 / 230	0.002 / 230			mA
Control Current (I <sub>pd</sub> )	V <sub>pd</sub> = 5V		7	7			mA
Switching Speed	t <sub>ON</sub> , t <sub>OFF</sub>		30	30			ns

Information furnished by Analog Devices is believed to be accurate and reliable. However, no responsibility is assumed by Analog Devices for its use, nor for any infringements of patents or other rights of third parties that may result from its use. Specifications subject to change without notice. No license is granted by implication or otherwise under any patent or patent rights of Analog Devices. Trademarks and registered trademarks are the property of their respective owners.

For price, delivery, and to place orders: Analog Devices, Inc., One Technology Way, P.O. Box 9106, Norwood, MA 02062-9106  
Phone: 781-329-4700 • Order online at [www.analog.com](http://www.analog.com)  
Application Support: Phone: 1-800-ANALOG-D

# HMC407\* PRODUCT PAGE QUICK LINKS

Last Content Update: 02/23/2017

---

## COMPARABLE PARTS

View a parametric search of comparable parts.

## EVALUATION KITS

- HMC407MS8G Evaluation Board

## DOCUMENTATION

### Application Notes

- AN-1363: Meeting Biasing Requirements of Externally Biased RF/Microwave Amplifiers with Active Bias Controllers
- Broadband Biasing of Amplifiers General Application Note
- MMIC Amplifier Biasing Procedure Application Note
- Thermal Management for Surface Mount Components General Application Note

### Data Sheet

- HMC407 Data Sheet

## TOOLS AND SIMULATIONS

- HMC407 S-Parameter

## REFERENCE MATERIALS

### Quality Documentation

- HMC Legacy PCN: MS##, MS##E and MS##G,MS##GE packages - Relocation of pre-existing production equipment to new building
- Package/Assembly Qualification Test Report: MS8G (QTR: 2014-00393)
- PCN: MS, QS, SOT, SOIC packages - Sn/Pb plating vendor change
- Semiconductor Qualification Test Report: GaAs HBT-B (QTR: 2013-00229)

## DESIGN RESOURCES

- HMC407 Material Declaration
- PCN-PDN Information
- Quality And Reliability
- Symbols and Footprints

## DISCUSSIONS

View all HMC407 EngineerZone Discussions.

## SAMPLE AND BUY

Visit the product page to see pricing options.

## TECHNICAL SUPPORT

Submit a technical question or find your regional support number.

## DOCUMENT FEEDBACK

Submit feedback for this data sheet.

---



**GaAs InGaP HBT MMIC  
POWER AMPLIFIER, 5 - 7 GHz**

**Broadband Gain & Return Loss**

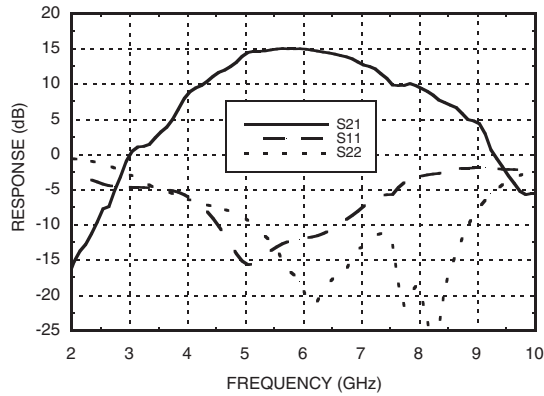

**Gain vs. Temperature**

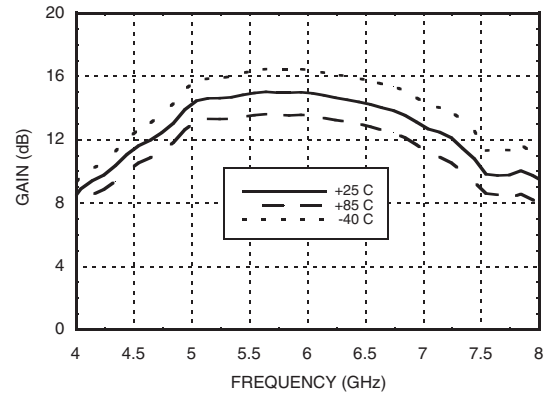

**Input Return Loss vs. Temperature**

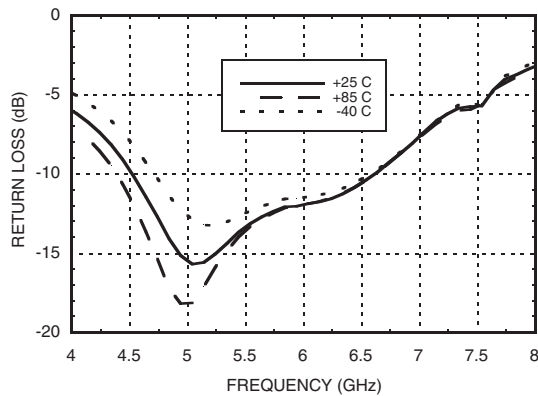

**Output Return Loss vs. Temperature**

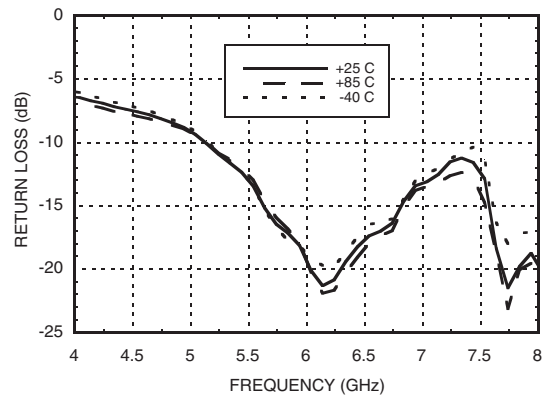

**P1dB vs. Temperature**

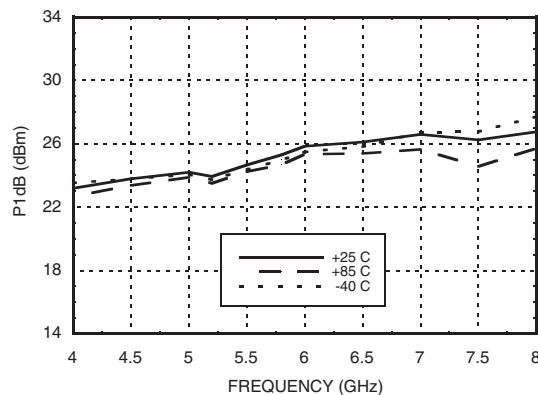

**Psat vs. Temperature**

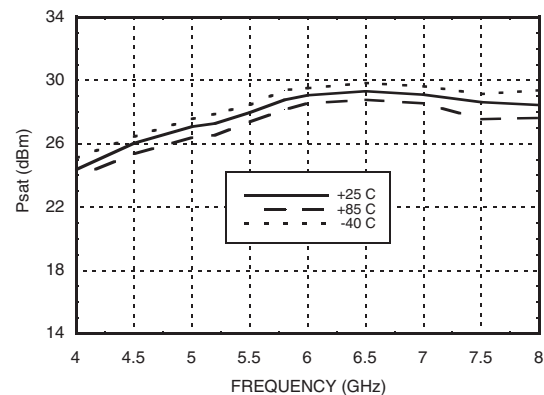

Information furnished by Analog Devices is believed to be accurate and reliable. However, no responsibility is assumed by Analog Devices for its use, nor for any infringements of patents or other rights of third parties that may result from its use. Specifications subject to change without notice. No license is granted by implication or otherwise under any patent or patent rights of Analog Devices. Trademarks and registered trademarks are the property of their respective owners.

For price, delivery, and to place orders: Analog Devices, Inc., One Technology Way, P.O. Box 9106, Norwood, MA 02062-9106 Phone: 781-329-4700 • Order online at [www.analog.com](http://www.analog.com) Application Support: Phone: 1-800-ANALOG-D



**GaAs InGaP HBT MMIC  
POWER AMPLIFIER, 5 - 7 GHz**

**Power Compression @ 5.8 GHz**

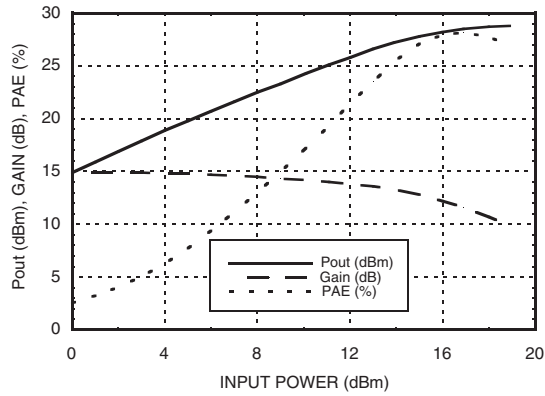

**Output IP3 vs. Temperature**

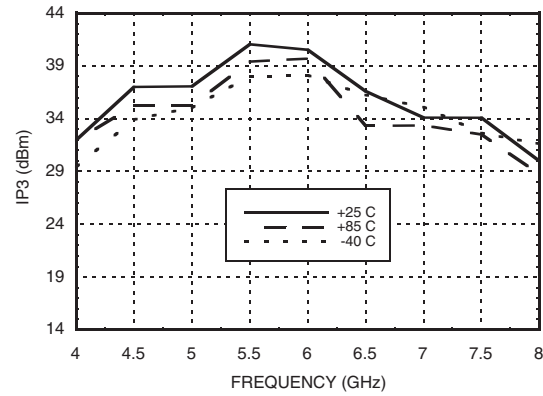

**Noise Figure vs. Temperature**

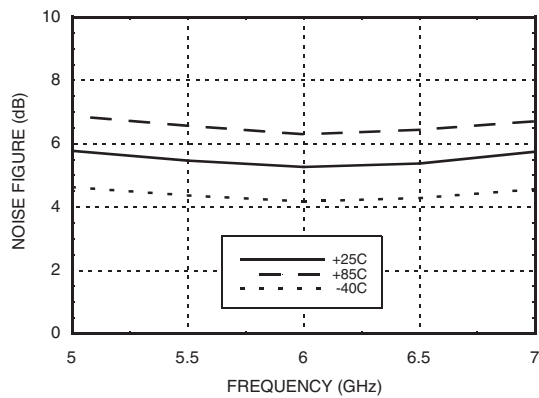

**Gain & Power vs. Supply Voltage**

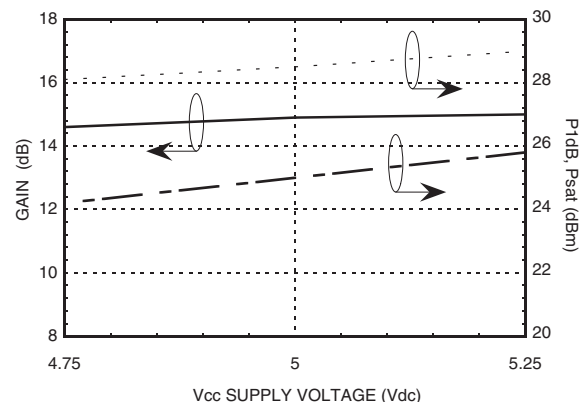

**Reverse Isolation vs. Temperature**

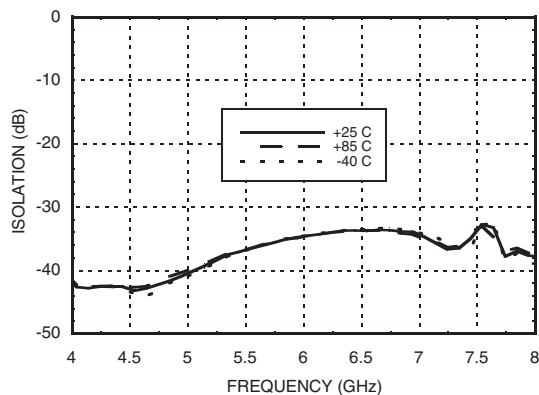

**Power Down Isolation**

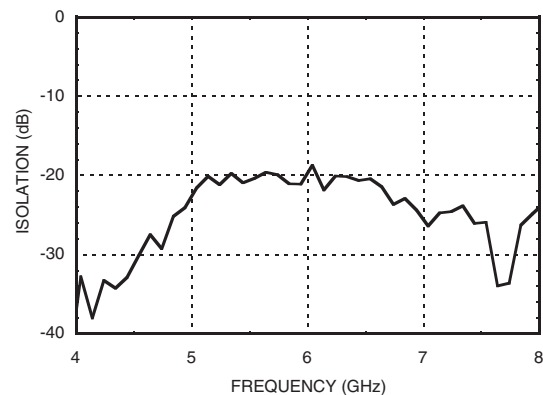

Information furnished by Analog Devices is believed to be accurate and reliable. However, no responsibility is assumed by Analog Devices for its use, nor for any infringements of patents or other rights of third parties that may result from its use. Specifications subject to change without notice. No license is granted by implication or otherwise under any patent or patent rights of Analog Devices. Trademarks and registered trademarks are the property of their respective owners.

For price, delivery, and to place orders: Analog Devices, Inc., One Technology Way, P.O. Box 9106, Norwood, MA 02062-9106 Phone: 781-329-4700 • Order online at [www.analog.com](http://www.analog.com) Application Support: Phone: 1-800-ANALOG-D

## GaAs InGaP HBT MMIC POWER AMPLIFIER, 5 - 7 GHz



### Gain, Power & Quiescent Supply Current vs. Vpd @ 5.8 GHz

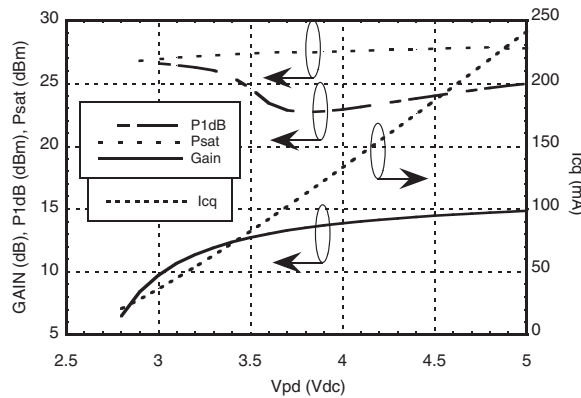

### Absolute Maximum Ratings

Collector Bias Voltage (Vcc1, Vcc2)	+5.5 Vdc
Control Voltage (Vpd)	+5.5 Vdc
RF Input Power (RFIN)(Vs = Vpd = +5Vdc)	+20 dBm
Junction Temperature	150 °C
Continuous P <sub>diss</sub> (T = 85 °C) (derate 31 mW/°C above 85 °C)	2 W
Thermal Resistance (junction to ground paddle)	32 °C/W
Storage Temperature	-65 to +150 °C
Operating Temperature	-40 to +85 °C



ELECTROSTATIC SENSITIVE DEVICE  
OBSERVE HANDLING PRECAUTIONS

### Outline Drawing

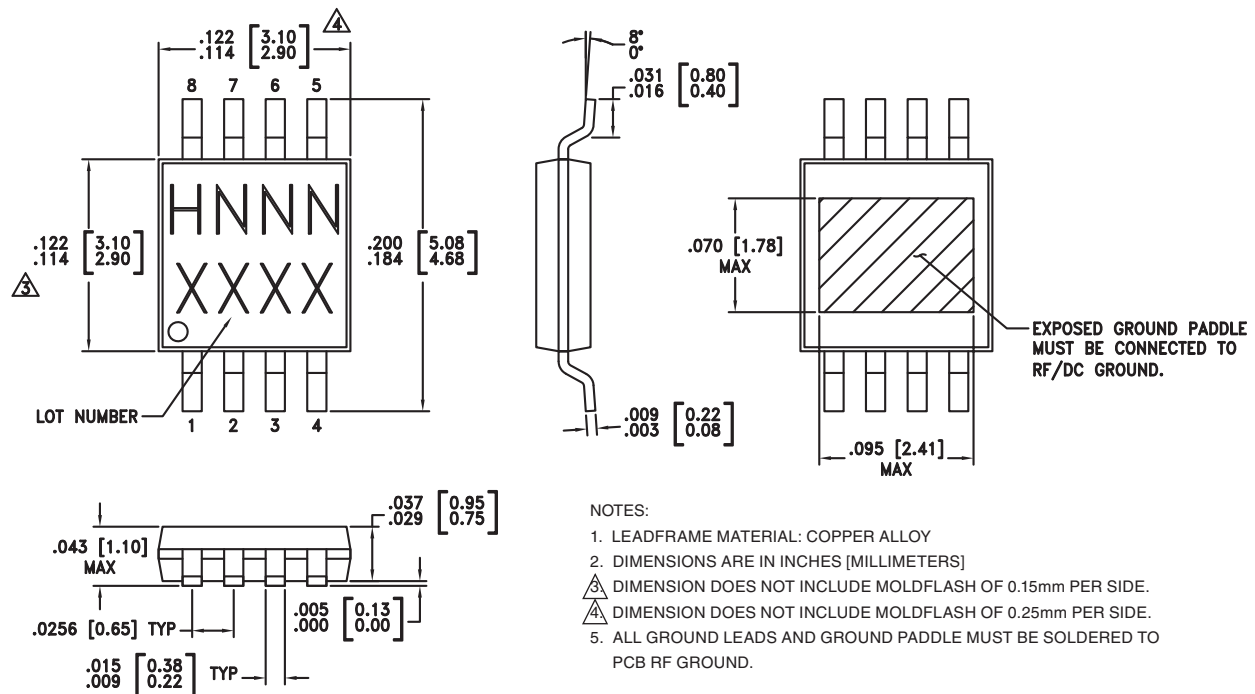

### Package Information

Part Number	Package Body Material	Lead Finish	MSL Rating	Package Marking <sup>[3]</sup>
HMC407MS8G	Low Stress Injection Molded Plastic	Sn/Pb Solder	MSL1 <sup>[1]</sup>	H407 XXXX
HMC407MS8GE	RoHS-compliant Low Stress Injection Molded Plastic	100% matte Sn	MSL1 <sup>[2]</sup>	H407 XXXX

[1] Max peak reflow temperature of 235 °C

[2] Max peak reflow temperature of 260 °C

[3] 4-Digit lot number XXXX



### Pin Descriptions

Pin Number	Function	Description	Interface Schematic
1	Vcc1	Power supply voltage for the first amplifier stage. An external bypass capacitor of 330 pF is required as shown in the application schematic.	
2	Vpd	Power control pin. For maximum power, this pin should be connected to 5V. A higher voltage is not recommended. For lower die current, this voltage can be reduced.	
3, 6, 7	GND	Ground: Backside of package has exposed metal ground slug that must be connected to ground thru a short path. Vias under the device are required.	
4	RFIN	This pin is AC coupled and matched to 50 Ohms.	
5	RFOUT	This pin is AC coupled and matched to 50 Ohms.	
8	Vcc2	Power supply voltage for the output amplifier stage. An external bypass capacitor of 330 pF is required. This capacitor should be placed no more than 20 mils from package lead.	

### Application Circuit

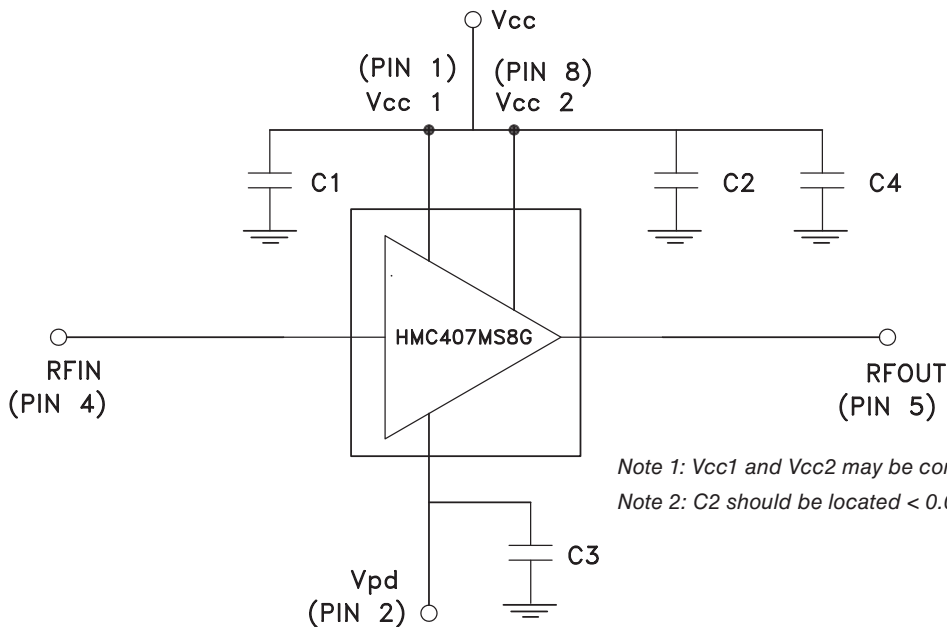

Note 1: Vcc1 and Vcc2 may be connected to a common Vcc.

Note 2: C2 should be located < 0.020" from Pin 8 (Vcc2).



## Evaluation PCB

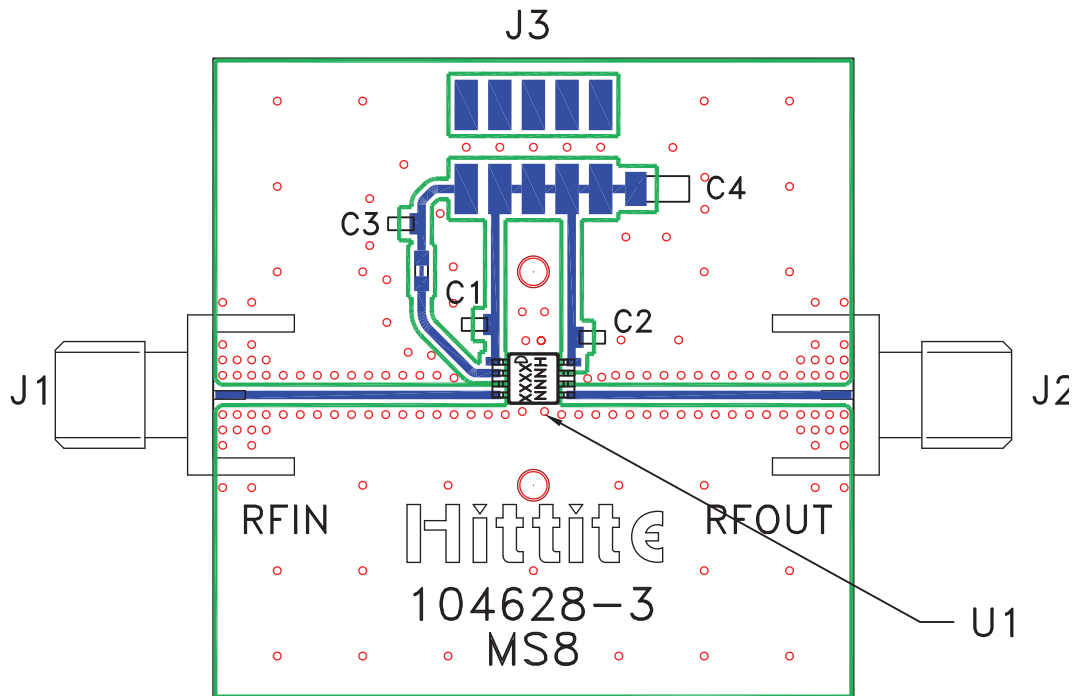

### List of Materials for Evaluation PCB 104987 [1]

Item	Description
J1 - J2	PCB Mount SMA RF Connector
J3	2 mm DC Header
C1 - C3	330 pF Capacitor, 0603 Pkg.
C4	2.2 μF Capacitor, Tantalum
U1	HMC407MS8G / HMC407MS8GE Amplifier
PCB [2]	104628 Eval Board

[1] Reference this number when ordering complete evaluation PCB

[2] Circuit Board Material: Roger 4350

The circuit board used in the final application should use RF circuit design techniques. Signal lines should have 50 ohm impedance while the package ground leads and exposed paddle should be connected directly to the ground plane similar to that shown. A sufficient number of via holes should be used to connect the top and bottom ground planes. The evaluation board should be mounted to an appropriate heat sink. The evaluation circuit board shown is available from Hittite upon request.