Touch Sensing Software Evaluation Board Users Guide

Document Number: TSSEVBUG
Rev. 6
7/2010

How to Reach Us:

Home Page:

www.freescale.com

E-mail:

support@freescale.com

USA/Europe or Locations Not Listed:

Freescale Semiconductor
Technical Information Center, CH370
1300 N. Alma School Road
Chandler, Arizona 85224
+1-800-521-6274 or +1-480-768-2130
support@freescale.com

Europe, Middle East, and Africa:

Freescale Halbleiter Deutschland GmbH
Technical Information Center
Schatzbogen 7
81829 Muenchen, Germany
+44 1296 380 456 (English)
+46 8 52200080 (English)
+49 89 92103 559 (German)
+33 1 69 35 48 48 (French)
support@freescale.com

Japan:

Freescale Semiconductor Japan Ltd.
Headquarters
ARCO Tower 15F
1-8-1, Shimo-Meguro, Meguro-ku,
Tokyo 153-0064, Japan
0120 191014 or +81 3 5437 9125
support.japan@freescale.com

Asia/Pacific:

Freescale Semiconductor China Ltd.
Exchange Building 23F
No. 118 Jianguo Road
Chaoyang District
Beijing 100022
China
+86 10 5879 8000
support.asia@freescale.com

For Literature Requests Only:

Freescale Semiconductor Literature Distribution Center
1-800-441-2447 or 303-675-2140
Fax: 303-675-2150
LDCForFreescaleSemiconductor@hibbertgroup.com

Information in this document is provided solely to enable system and software implementers to use Freescale Semiconductor products. There are no express or implied copyright licenses granted hereunder to design or fabricate any integrated circuits or integrated circuits based on the information in this document.

Freescale Semiconductor reserves the right to make changes without further notice to any products herein. Freescale Semiconductor makes no warranty, representation or guarantee regarding the suitability of its products for any particular purpose, nor does Freescale Semiconductor assume any liability arising out of the application or use of any product or circuit, and specifically disclaims any and all liability, including without limitation consequential or incidental damages. "Typical" parameters that may be provided in Freescale Semiconductor data sheets and/or specifications can and do vary in different applications and actual performance may vary over time. All operating parameters, including "Typicals", must be validated for each customer application by customer's technical experts. Freescale Semiconductor does not convey any license under its patent rights nor the rights of others. Freescale Semiconductor products are not designed, intended, or authorized for use as components in systems intended for surgical implant into the body, or other applications intended to support or sustain life, or for any other application in which the failure of the Freescale Semiconductor product could create a situation where personal injury or death may occur. Should Buyer purchase or use Freescale Semiconductor products for any such unintended or unauthorized application, Buyer shall indemnify and hold Freescale Semiconductor and its officers, employees, subsidiaries, affiliates, and distributors harmless against all claims, costs, damages, and expenses, and reasonable attorney fees arising out of, directly or indirectly, any claim of personal injury or death associated with such unintended or unauthorized use, even if such claim alleges that Freescale Semiconductor was negligent regarding the design or manufacture of the part.



Freescale™ and the Freescale logo are trademarks of Freescale Semiconductor, Inc. ARC, the ARC logo, ARCangel, ARCform, ARChitect, ARCcompact, ARctangent, BlueForm, CASSEIA, High C/C++, High C++, iCon186, MetaDeveloper, MQX, Precise Solution, Precise/BlazeNet, Precise/EDS, Precise/MFS, Precise/MQX, Precise/MQX Test Suites, Precise/RTCS, RTCS, SeeCode, TotalCore, Turbo186, Turbo86, V8 µ RISC, V8 microRISC, and VAutomation are trademarks of ARC International. High C and MetaWare are registered under ARC International. The PowerPC name is a trademark of IBM Corp. and is used under license. The described product contains a PowerPC processor core. The PowerPC name is a trademark of IBM Corp. and used under license. The described product is a PowerPC microprocessor. The PowerPC name is a trademark of IBM Corp. and is used under license. The described product is a PowerPC microprocessor core. The PowerPC name is a trademark of IBM Corp. and is used under license. All other product or service names are the property of their respective owners.

© 1994-2008 ARC™ International. All rights reserved.

© Freescale Semiconductor, Inc. 2009. All rights reserved.

Document Number: TSSEVBUG

Rev. 6

7/2010

Revision History

To provide the most up-to-date information, the revision of our documents on the World Wide Web will be the most current. Your printed copy may be an earlier revision. To verify you have the latest information available, refer to:

<http://www.freescale.com>

The following revision history table summarizes changes contained in this document.

Revision Number	Revision Date	Description of Changes
Rev. 1	07/2009	Launch Release.
Rev. 2	09/2009	Updated BOM, schematics, and silk screen.
Rev. 3	10/2009	Updated GPIO port allocation table.
Rev. 4	11/2009	Added Section 2.1.10, “Overlays” and Section 2.3.8.1, “Using the TSSEVB IIC Communication Module” sections.
Rev. 5	12/2009	Added Section 2.1.1, “TSSEVB Modules” and Section 3.1.1, “Re-Programming MC9S08JM60 Comm MCU on the TSSEVB” sections.
Rev. 6	7/2010	Edits done

Freescale™ and the Freescale logo are trademarks of Freescale Semiconductor, Inc.
© Freescale Semiconductor, Inc., 2009. All rights reserved.

Chapter 1

Before You Begin

1.1	About This Book	1-1
1.2	Reference Material	1-1
1.3	Conventions	1-1
1.4	Acronyms and Abbreviations	1-2

Chapter 2

System Overview

2.1	Introduction	2-1
2.2	Features	2-1
2.2.1	TSSEVB Modules	2-1
2.2.2	Microcontroller Unit (MCU)	2-2
2.2.3	General-Purpose I/O and Peripheral Ports	2-3
2.2.4	Power Supply	2-5
2.2.5	Buzzer	2-6
2.2.6	Clock	2-6
2.2.7	LCD	2-6
2.2.8	TSSEVB Electrodes	2-6
2.2.9	RESET	2-7
2.2.10	Overlays	2-7
2.3	Schematic and Bill of Materials (BOM)	2-7
2.3.1	TSSEVB Bill of Materials	2-15
2.3.2	TSSEVB Silk Screen	2-17
2.4	Header and Jumper Connections	2-17
2.4.1	USB Power Selection	2-17
2.4.2	External Power Supply	2-18
2.4.3	Voltage Selection	2-18
2.4.4	MC9S08LG32 UART	2-19
2.4.5	Test Points	2-19
2.4.6	BDM Header	2-20
2.4.7	Comm PORT	2-20
2.4.8	IIC Communication	2-20
2.4.8.1	Using the TSSEVB IIC Communication Module	2-21

Chapter 3

TSSEVB Interfaces

3.1	MC9S08JM60 Comm MCU	3-1
3.1.1	Re-Programming MC9S08JM60 Comm MCU on the TSSEVB	3-1
3.2	IIC Interface	3-2

3.3	USB Interface	3-2
3.4	SCI Interface	3-2
3.5	OSBDM MCU	3-2
3.6	Additional BDM Connector for MC9S08LG32	3-2

Chapter 1

Before You Begin

1.1 About This Book

This guide describes the hardware of the Touch Sensing Software Evaluation Board (TSSEVB). The TSSEVB provides all the necessary components to evaluate and use the Touch Sensing Software (TSS). TSSEVB is built around Freescale's TSS library. The Freescale MC9S08LG32 microcontroller unit uses the TSS library.

This *TSSEVB Users Guide* is written for software, hardware, and system engineers, who are developing their products or software applications using the TSS library to integrate capacitive sensing.

Table 1-1 shows the summary of chapters in this guide.

Table 1-1. TSSEVB Summary

Chapter Title	Description
Before You Begin	Lists the prerequisites of reading this book.
System Overview	Provides information about the microcontroller part and its surrounding.
TSSEVB Interfaces	Describes the board design and ways to interface with the board.

1.2 Reference Material

Use this book in conjunction with:

- *Touch Sensing Software Users Guide* (document TSSUG)
- *Touch Sensing Software API Reference Manual* (document TSSAPIRM)
- *Touch Sensing Software EVB Quick Start Guide* (document TSSEVBQSG)

1.3 Conventions

This guide uses the following notations:

- Courier monospaced type indicates commands, command parameters, code examples, expressions, datatypes, and directives.
- Italic type indicates replaceable command parameters.
- All source code examples are in C.

1.4 Acronyms and Abbreviations

BOM	Bill of Material
CPU	Central Processing Unit
Comm MCU	Communication Microcontroller Unit
EGT	Electrode Graphing Tool
FLL	Frequency-Locked Loop
GPIO	General-Purpose Input/Output
IIC	Inter-Integrated Circuit
ICS	Internal Clock Source
LG MCU	MC9S08LG32 Microcontroller Unit
MCU	Microcontroller Unit
OSBDM	Open Source Background Debug Module
PC	Personal Computer
PCB	Printed Circuit Board
QFN	Quad Flat Non-lead package
RAM	Random Access Memory
Rx	Receiver
SCI	Serial Communication Interface
SPI	Serial Peripheral Interface
TSSEVB	Touch Sensing Software Evaluation Board
Tx	Transmitter

Chapter 2

System Overview

2.1 Introduction

This chapter describes the basic components, functionality, and power supply options of TSSEVB. It also includes the schematic and Bill of Materials (BOM) for the TSSEVB. For more information on how to set the Freescale Touch Sensing Software primitives and the development environment, refer to the *Touch Sensing Software API Reference Manual* (document TSSAPIRM).

Features of TSSEVB:

- TSSEVB includes a demonstration application that allows you to start testing TSS within minutes.
- TSSEVB includes a Communication MCU (MC9S08JM60 Comm MCU) that serves as a bridge between the application and the PC to evaluate the Electrode Graphing Tool (EGT) along with TSS.
- TSSEVB includes all the decoding structures supported by TSS along with special electrodes, such as different size electrodes and multiplexed electrodes supported by TSS.
- The EVB also contains a custom on-board display that allows you to explore the software development combining the integrated LCD driver with TSS. The LCD contains special segments to be used with TSS.
- TSSEVB includes an MC9S08LG32 device from the S08 family of 8-bit microcontrollers. The LG family offers improved performance and flexible pin functionality for a wide range of industrial and automotive applications, such as electric metering, home appliances, HVAC systems, and entry level instrument clusters.
- TSSEVB includes an OSBDM module that allows programming of the MC9S08LG32 MCU and the MC9S08JM60 Comm MCU. There is no need to use an external BDM module to load applications into the MC9S08LG32 MCU.
- TSSEVB can be powered using three different sources:
 - Through the USB port
 - Through the mini USB port
 - By connecting the board to the voltage converter included in the TSSEVB kit.

2.1.1 TSSEVB Modules

Figure 2-1 shows the front view of TSSEVB and the main modules present.

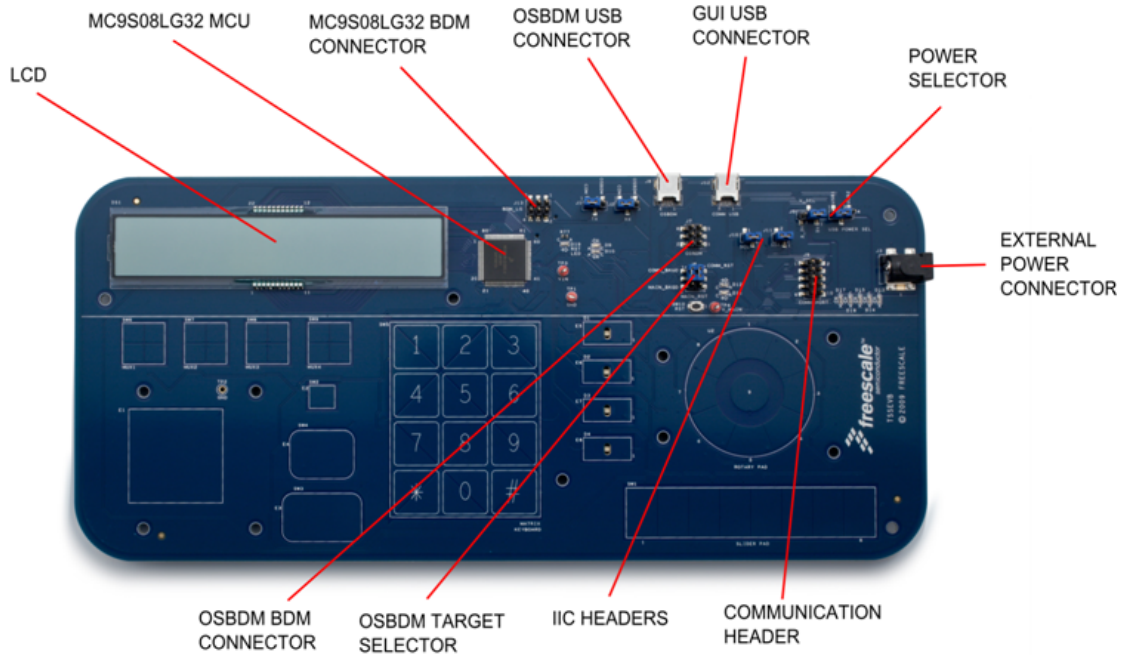

Figure 2-1. TSSEVB front view

Figure 2-2 shows the back view of TSSEVB and the main modules present.

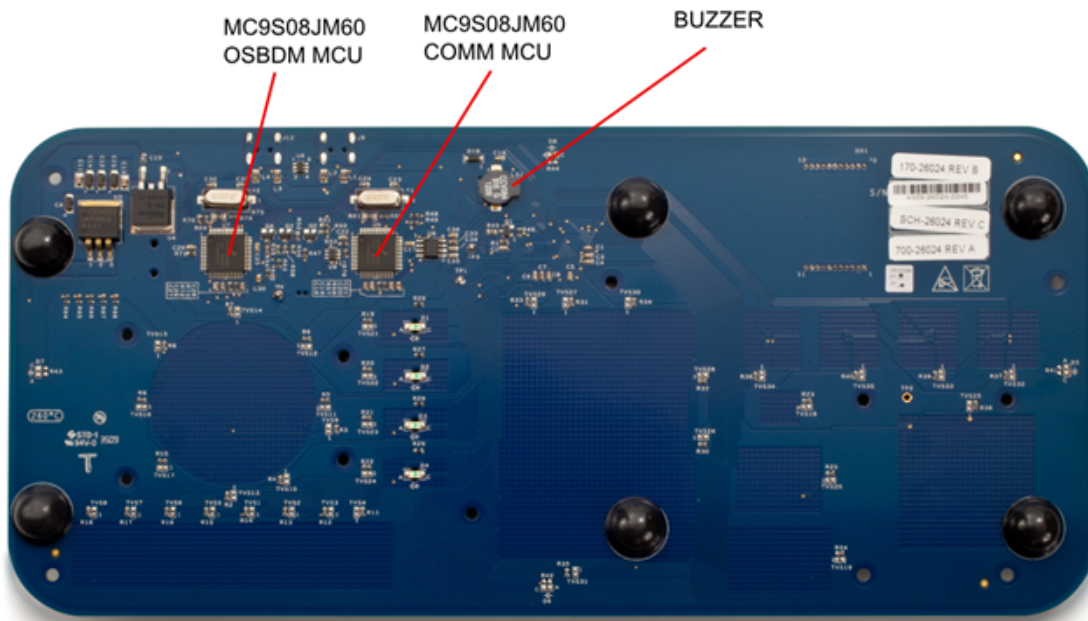

Figure 2-2. TSSEVB back view

2.1.2 Microcontroller Unit (MCU)

MC9S08LG32 drives liquid crystal displays (LCD) with up to 296 segments. The 5V segment LCD MCU, MC9S08LG32 offers improved performance and flexible pin functionality for a wide range of industrial

and automotive applications, such as electric metering, home appliances, HVAC systems, and entry level instrument cluster. The MC9S08LG32 has 32 KB of on-chip programmable flash memory and 2 KB of RAM available.

The MC9S08LG32 provides an LCD driver module, configurable up to 8×37 or 4×41 . The LCD driver module remains active even in low-power modes. It also includes an internal regulated charge pump for contrast control. All LCD pins are multiplexed with GPIOs.

TSSEVB uses the MC9S08LG32 Inter-Integrated Circuit (IIC) module to establish communication with the MC9S08JM60 Comm MCU when the TSSEVB is used along with EGT. To use the IIC module with the EGT, jumpers on headers J10 and J11 respectively must be properly configured. For more information on jumper configurations, refer to [Section 2.3, “Header and Jumper Connections.”](#)

The EVB includes two MC9S08JM60 MCUs, one is open source BDM that is used to program and debug, while the other is used to communicate with the EGT GUI on a PC.

The MC9S08LG32 includes a Serial Communication Interface (SCI) module. The SCI module can be connected to both MC9S08JM60 MCUs included in the TSSEVB and you can select either by changing the position on J1 and J2 jumpers. The SCI module is included in the TSSEVB for future demo applications.

MC9S08LG32 is packaged in an 80-pin quad flat non-lead package (QFN).

2.1.3 General-Purpose I/O and Peripheral Ports

MC9S08LG32 has nine I/O ports that include a total of up to 69 GPIO pins. Most of these pins are shared with the on-chip peripherals such as timer systems, external interrupts, or keyboard interrupts. When these modules are not controlling the port pins, they revert to GPIO control. Immediately after reset, all 69 GPIO pins are configured as high-impedance general-purpose inputs with internal pull-up devices disabled. The port allocation of the general-purpose I/O and on-chip peripheral functions on the EVB are listed in [Table 2-1](#) along with a brief description.

Table 2-1. GPIO Port Allocation

MCU Port	TSSEVB Functionality	I/O	Description
PTA0/LCD21	LCD21	I/O	LCD Control pin
PTA1/SCL/LCD22	ER9	I	Rotary Structure Electrode
PTA2/SDA/ADC0/LCD23	EGR1	I	Different Size Electrode
PTA3/KBI4/TX2/ADC1/LCD24	OSBDM_TX/COM_TX	O	SCI Transmitter (future use)
PTA4/KBI5/RX2/ADC2/LCD25	OSBDM_RX/COM_RX	I	SCI Receiver (future use)
PTA5/KBI6/TPM2CH0/ADC3/LCD26	ETK_6	I	Numeric Keyboard Electrode
PTA6/KBI7/TPM2CH1/ADC4/LCD27	Buzzer	O	Buzzer
PTA7/TCLK/ADC5/LCD28	ETK_5	I	Numeric Keyboard Electrode
PTB0/LCD29	ESLIDER1	I	Slider Structure Electrode
PTB1/LCD30	ESLIDER2	I	Slider Structure Electrode

Table 2-1. GPIO Port Allocation (continued)

MCU Port	TSSEVB Functionality	I/O	Description
PTB2/LCD31	ESLIDER7	I	Slider Structure Electrode
PTB3/LCD32	ESLIDER8	I	Slider Structure Electrode
PTB4/LCD37	ESLIDER3	I	Slider Structure Electrode
PTB5/LCD38	ESLIDER4	I	Slider Structure Electrode
PTB6/LCD39	ESLIDER5	I	Slider Structure Electrode
PTB7/LCD40	ESLIDER6	I	Slider Structure Electrode
PTC0/LCD16	LCD16	I/O	LCD Control pin
PTC1/LCD17	LCD17	I/O	LCD Control pin
PTC2/LCD18	LCD18	I/O	LCD Control pin
PTC3/LCD19	LCD19	I/O	LCD Control pin
PTC4/LCD20	LCD20	I/O	LCD Control pin
PTC5/BKGD/MS	MAIN_BKGD	I/O	MCU Programming pin
PTC6/RESET	MAIN_RST	I/O	MCU Reset pin
PTD0/LCD0	LCD0	I/O	LCD Control pin
PTD1/LCD1	LCD1	I/O	LCD Control pin
PTD2/LCD2	LCD2	I/O	LCD Control pin
PTD3/LCD3	LCD3	I/O	LCD Control pin
PTD4/LCD4	LCD4	I/O	LCD Control pin
PTD5/LCD5	LCD5	I/O	LCD Control pin
PTD6/LCD6	LCD6	I/O	LCD Control pin
PTD7/LCD7	LCD7	I/O	LCD Control pin
PTE0/LCD8,	LCD8	I/O	LCD Control pin
PTE1/LCD9	LCD9	I/O	LCD Control pin
PTE2/LCD10,	LCD10	I/O	LCD Control pin
PTE3/LCD11	LCD11	I/O	LCD Control pin
PTE4/LCD12	LCD12	I/O	LCD Control pin
PTE5/LCD13	LCD13	I/O	LCD Control pin
PTE6/LCD14	LCD14	I/O	LCD Control pin
PTE7/LCD15	LCD15	I/O	LCD Control pin
PTF0/TX1/KBI3/TPM2CH2/ADC12	ERL1	I	Electrode with LED
PTF1/RX1/TPM1CH0/ADC13	ERL2	I	Electrode with LED
PTF2/SPSCK/TPM1CH1/IRQ/ADC14	ERL3	I	Electrode with LED
PTF3/SS/KBI0/TPM2CH5	ES3	I	Different Size Electrode

Table 2-1. GPIO Port Allocation (continued)

MCU Port	TSSEVB Functionality	I/O	Description
PTF4/MISO/KBI1/TPM2CH4	ER2	I	Rotary Structure Electrode
PTF5/MOSI/KBI2/TPM2CH3	ER1	I	Rotary Structure Electrode
PTF6/XTAL	LED_ER2	O	Electrode's LED
PTF7/XTAL	LED_ER1	O	Electrode's LED
PTG0/LCD33	EMUX1	I	Multiplexed Electrode
PTG1/LCD34	EMUX2	I	Multiplexed Electrode
PTG2/LCD35	LED_ER3	O	Electrode's LED
PTG3/LCD36	ER8	I	Rotary Structure Electrode
PTG4/LCD41	EMUX3	I	Multiplexed Electrode
PTG5/LCD42	EMUX4	I	Multiplexed Electrode
PTG6/LCD43	LED_ER4	O	Electrode's LED
PTG7/LCD44	NC	-	—
PTH0/KBI4/ADC6	ETK_4	I	Numeric Keyboard Electrode
PTH1/KBI5/ADC7	ETK_3	I	Numeric Keyboard Electrode
PTH2/KBI6/ADC8	ETK_2	I	Numeric Keyboard Electrode
PTH3/KBI7/ADC9	ETK_1	I	Numeric Keyboard Electrode
PTH4/RX1/KBI2/TPM1CH1/ADC10	ES1	I	Different Size Electrode
PTH5/TX1/KBI3/TPM1CH0/ADC11	ES2	I	Different Size Electrode
PTH6/TPM2CH5/KBI0/ADC15	ERL4	I	Electrode with LED
PTH7/KBI1/TPM2CH4	ER7	I	Rotary Structure Electrode
PTI0/RX2	ER6	I	Rotary Structure Electrode
PTI1/TMRCLK/TX2	ER5	I	Rotary Structure Electrode
PTI2/TPM2CH3/MISO	ER4	I	Rotary Structure Electrode
PTI3/TPM2CH2/MOSI	ER3	I	Rotary Structure Electrode
PTI4/TPM2CH1/SDA/SPSCK	JM2_SDA	I/O	IIC module pin used for communication with the EGT
PTI5/TPM2CH0/SCL/SS	JM2_SCL	I/O	IIC module pin used for communication with the EGT

2.1.4 Power Supply

Power can be supplied to TSSEVB either through the USB connections by setting J4 or through an external power supply.

- To supply power to the TSSEVB through a USB connection, set the J4 jumper to the selected USB connection.

- To supply power to the board from the OSBDM, place the J4 jumper on the 1–2 positions.
- To supply power to the board from the MC9S08JM60 Comm MCU, place the jumper on the 2–3 positions.
- To supply power to the TSSEVB externally, plug the voltage converter included in the TSSEVB kit to the board's barrel connector. When using the external power supply, the voltage from the USB_BDM is automatically disconnected from the board. Refer to section [Section 2.3, “Header and Jumper Connections,”](#) for more information about how to configure the jumpers.

2.1.5 Buzzer

TSSEVB provides a piezoelectric speaker connected to the PTA6 pin of the MC9S08LG32 microcontroller. This speaker can be easily used with any touch sensing application.

2.1.6 Clock

TSSEVB uses the Internal Clock Source (ICS) of MC9S08LG32 to provide timing to the board. The ICS module contains a Frequency-Locked Loop (FLL) to increase the bus frequency using the internal clock as reference. For more information on the ICS module, refer to the *MC9S08LG32 Reference Manual* (document MC9S08LG32RM).

2.1.7 LCD

TSSEVB provides a custom LCD with special segments that can be used to represent each of the electrodes featured in the board. Depending on the application, these segments can change their functionality. When running the application demo, the LCD allows you to visualize the performance of the electrodes working along with the TSS. You can use the application demo code provided with the TSSEVB documentation as a guideline to configure and use the LCD on any application. The LCD can display up to 4 characters besides the special segments.

2.1.8 TSSEVB Electrodes

The TSSEVB provides all the decoding structures supported by the Touch Sensing Software, and also provides some special electrodes. The TSSEVB features the following electrodes structures.

- Rotary structure formed by 8 electrodes plus one electrode in the middle of the structure.
- Slider structure formed by 8 electrodes.
- Keyboard structure formed by 6 electrodes.
- 4 electrodes with an LED in the middle.
- 4 multiplexed electrodes.
- 4 electrodes of different sizes for user evaluation.

2.1.9 $\overline{\text{RESET}}$

$\overline{\text{RESET}}$ is a dedicated pin with a pull-up device built in. This pin is connected to the 6-pin BDM connector, therefore a development system can directly reset the MCU system. The reset switch (SW10) is active low and provides a way to apply a reset to the MCU. The reset switch is connected directly to the $\overline{\text{RESET}}$ signal of the MC9S08LG32 MCU. A 5.1 k Ω pull-up resistor to V_{DD} on the $\overline{\text{RESET}}$ signal allows normal operation preventing spurious reset detections. When the reset switch is pressed the $\overline{\text{RESET}}$ signal is grounded, and the MCU recognizes a reset.

2.1.10 Overlays

TSSEVB includes two detachable overlays provided by KEE Group. These overlays have an adhesive that can be used to place the overlay over the electrodes. These overlays can be used to test different dielectric constants placed over the electrodes. The overlays can be placed, and removed many times while retaining adherence.

2.2 Schematic and Bill of Materials (BOM)

This section contains the 13192-EVB schematic and BOM.

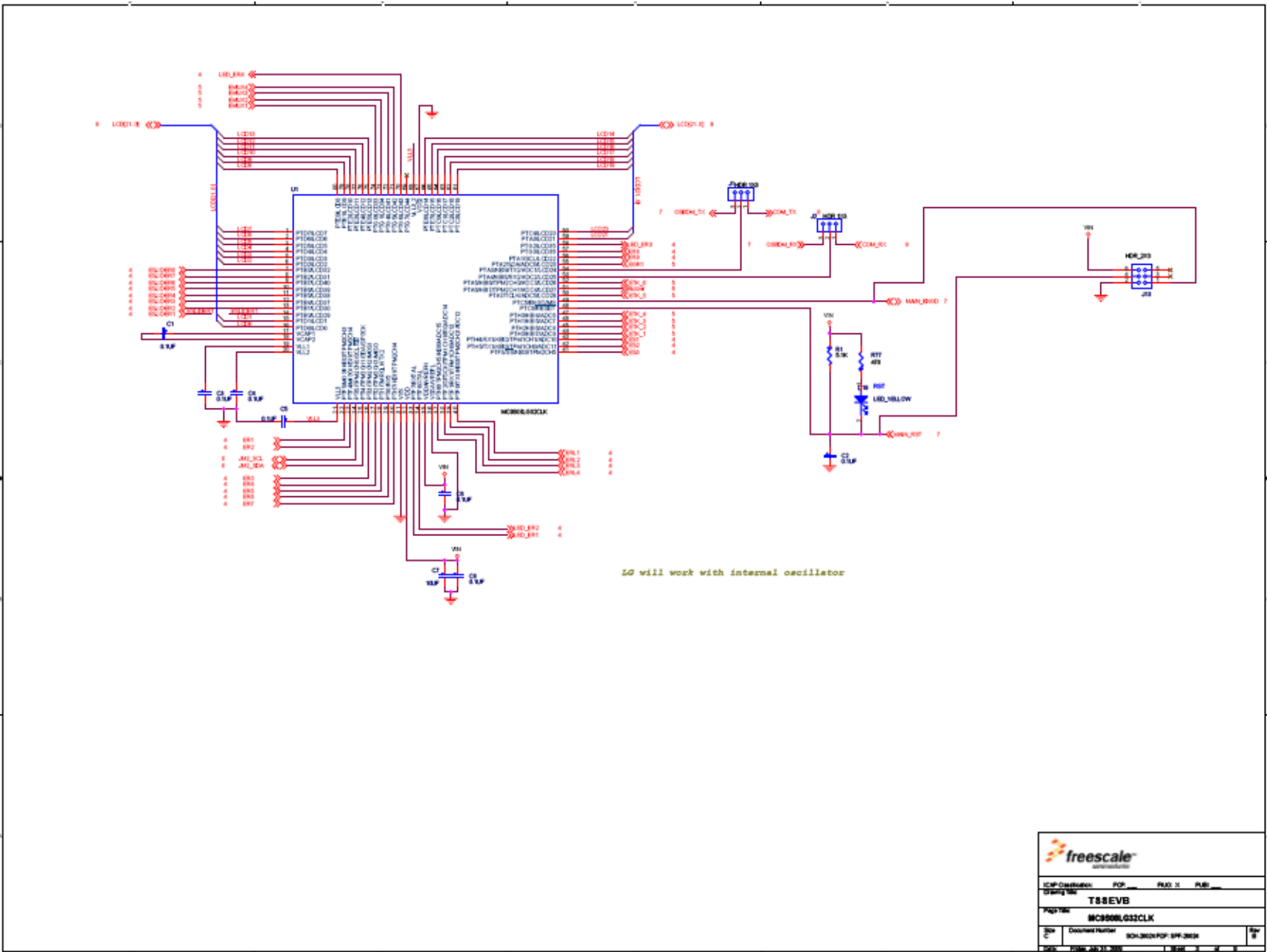

ICAP Overview:	FCP PLAT 21 PLB
Design No:	TS8EVB
Part No:	MC9300LG32CLK
Rev C	DOCUMENT NUMBER: SCH-38224-POP-001-2008 DATE: 03/04/08

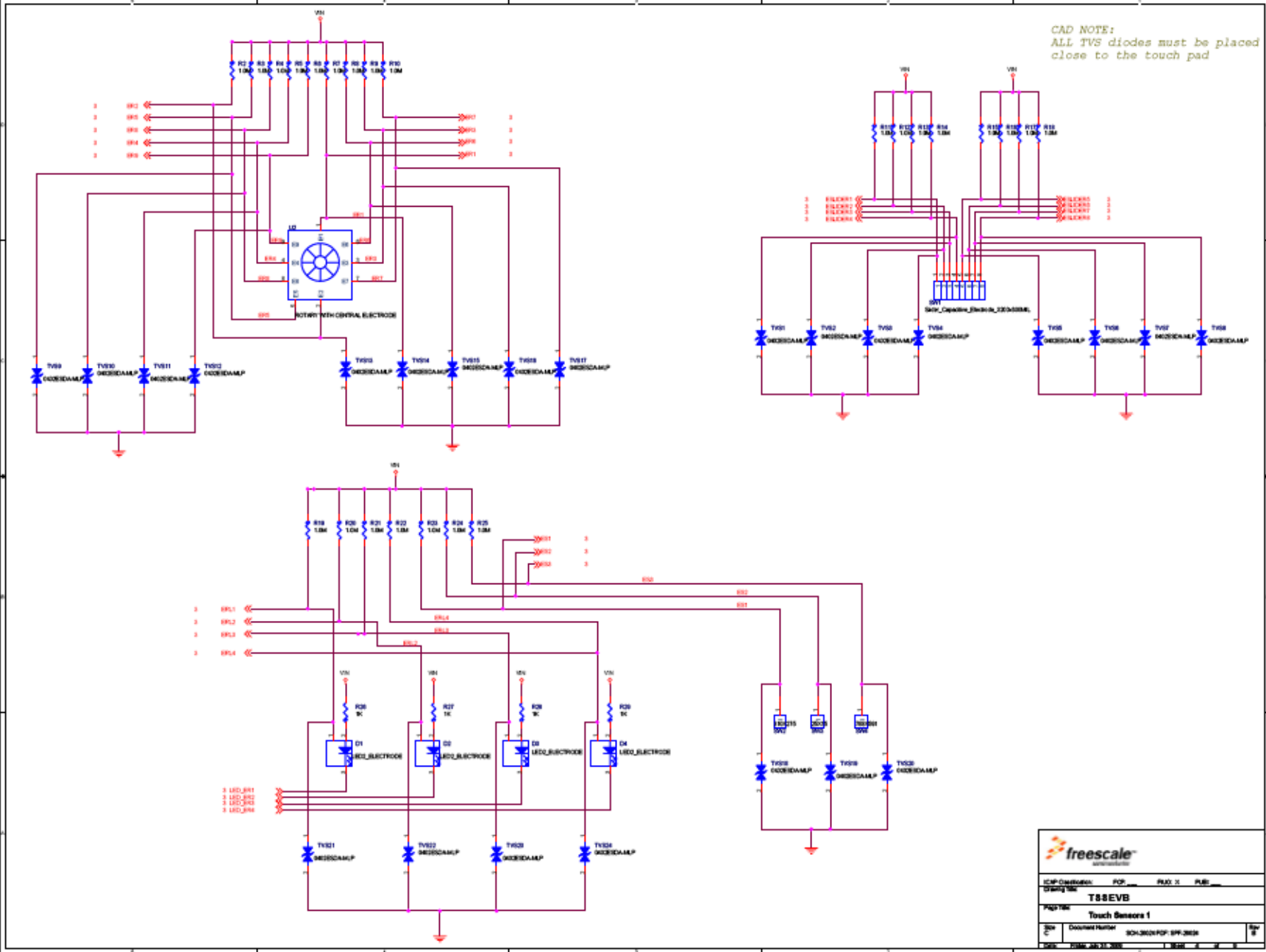

ICMP Contribution:	POP FLX1 X FLX0
Display Name:	TB8EVB
Part Name:	Touch Sensors 1
Doc C:	DocName/Number: 504-3020.PDF, 504-3020
Date:	7/28/11 10:31:20 AM

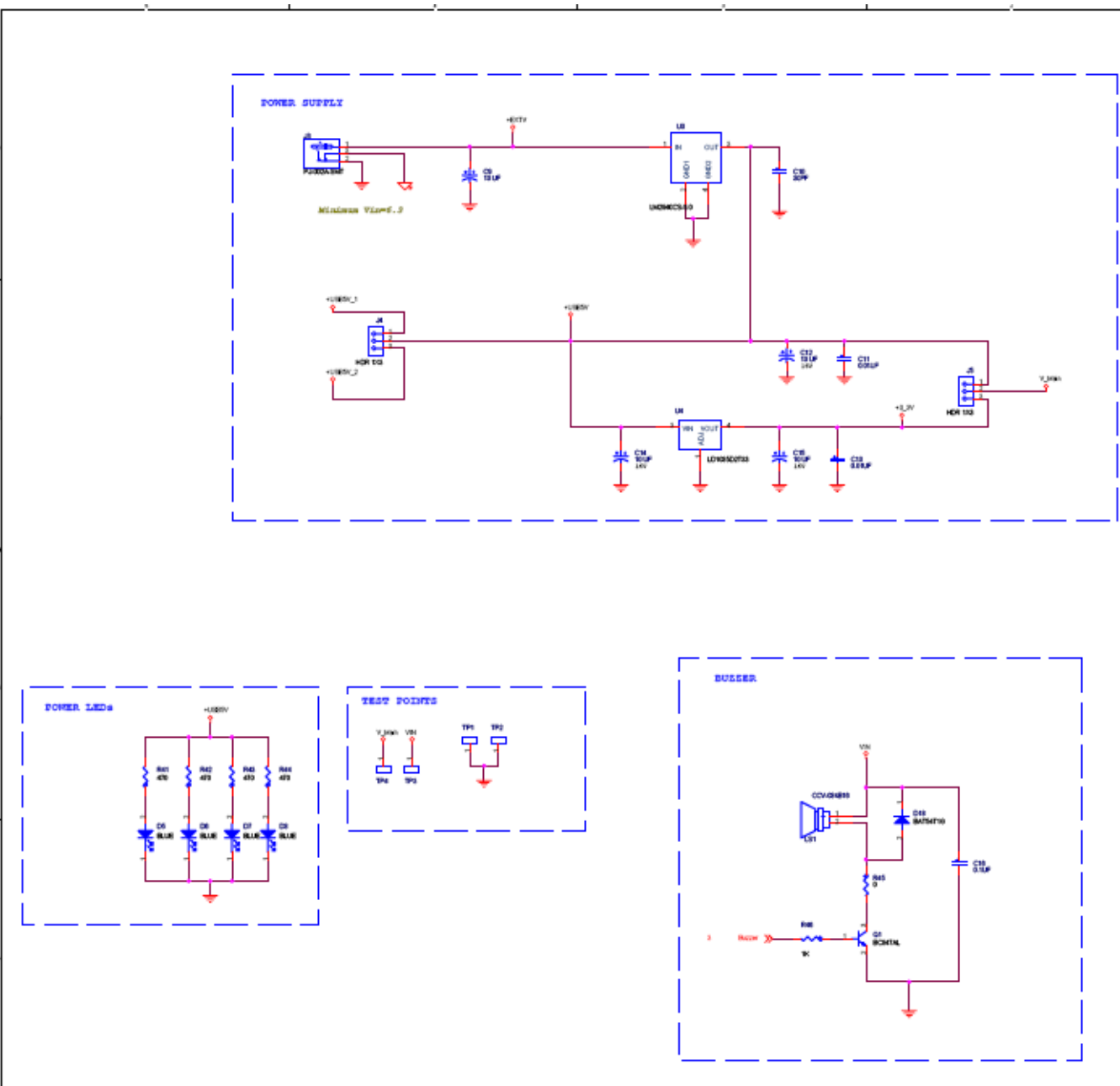

ICMP Classification:	POP, PAB, PLB
DocID: 3886	TS8EVB
Part No:	POWER
Doc No:	DAWG001470M SCH-2002/POP/SP/2003
Rev:	1

	
ICP Contribution:	POP: <input type="checkbox"/> PLX2: <input type="checkbox"/> PLB: <input type="checkbox"/>
Training:	TSBEVB
Part No:	LCD
Doc ID	Document Number: SCH-3824 POP: BPP-2824
Rev	Rev: 1

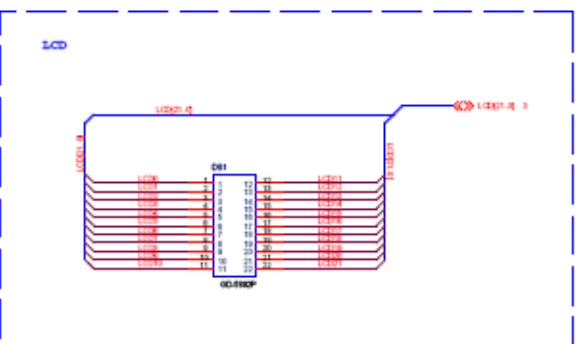

2.2.1 TSSEVB Bill of Materials

Table 2-2. TSSEVB Bill of Materials

Item	BOM.Qty	Manufacturers.Mfr. Name	Manufacturers.Mfr. Part Number	BOM.Ref Des
1	4	NIC COMPONENTS CORP	NTC-T106M16TRAF	C9,C12,C14,C15
2	17	KEMET	C0603C104K3RAC	C1,C2,C3,C4,C5,C6,C8,C16,C17,C19,C22,C25,C27,C29,C34,C35,C36
3	2	KEMET	C0603C474K4PAC	C20,C28
4	4	PANASONIC	ECJ1VB0J106M	C7,C18,C26,C33
5	2	KEMET	C0805C103KARACTU	C11,C13
6	2	AVX	TACL475K010R	C21,C30
7	5	AVX	06033A300KAT2A	C10,C23,C24,C31,C32
8	4	PANASONIC	EXCML20A390U	L1,L2,L3,L4
9	4	KEYSTONE ELECTRONICS	5005	TP1,TP2,TP3,TP4
10	4	SAMTEC	TSM-103-01-S-SV	J1,J2,J4,J5
11	1	SAMTEC	TSM-105-01-S-DV-A-P	J9
12	3	SAMTEC	TSM-103-01-S-DV-P-TR	J6,J7,J13
13	2	SAMTEC	TSM-102-01-SM-SV-P-TR	J10,J11
14	1	CUI STACK	PJ-002A-SMT	J3
15	2	MOLEX	0675031340	J8,J12
16	2	ABRACON CORP	ABLS-4.000MHZ-B2-T	Y1,Y2
17	1	TEXAS INSTRUMENTS	SN74LVC1T45DBVR	U9
18	1	MICREL	MIC2026-1YM	U8
19	2	FREESCALE SEMICONDUCTOR	MC9S08JM60CLD	U5,U7
20	1	NATIONAL SEMICONDUCTOR	LM2940CS-5.0/NOPB	U3
21	1	ST MICROELECTRONICS	LD1085D2T33R	U4
22	1	FREESCALE SEMICONDUCTOR	MC9S08LG32CLK	U1
23	4	LITE ON	LTST-C190TBKT	D5,D6,D7,D8
24	2	KINGBRIGHT	AP1608MGC	D9,D11
25	8	KINGBRIGHT	AP1608SYCK	D10,D12,D13,D14,D15,D16,D17,D19
26	1	S-TEK INC	GD-5892P	DS1
27	4	KOA SPEER	RK73H1JTDD5101F	R1,R53,R71,R76

Table 2-2. TSSEVB Bill of Materials (continued)

Item	BOM.Qty	Manufacturers.Mfr. Name	Manufacturers.Mfr. Part Number	BOM.Ref Des
28	9	KOA SPEER	RK73B1JTDD103J	R50,R51,R52,R54,R55,R56,R58,R69,R70
29	5	VENKEL COMPANY	CR0603-10W-102JT	R26,R27,R28,R29,R46
30	3	BOURNS	CR0805-J/-000ELF	R45,R61,R75
31	35	BOURNS	CR0603-JW-105ELF	R2,R3,R4,R5,R6,R7,R8,R9,R10,R11,R12,R13,R14,R15,R16,R17,R18,R19,R20,R21,R22,R23,R24,R25,R30,R31,R32,R33,R34,R35,R36,R37,R38,R39,R40
32	5	VISHAY INTERTECHNOLOGY	CRCW060333R0JNEA	R47,R57,R59,R72,R73
33	14	VENKEL COMPANY	CR0603-10W-471JT	R41,R42,R43,R44,R48,R49,R62,R63,R64,R65,R66,R67,R68,R77
34	1	ON SEMICONDUCTOR	BC847ALT1G	Q1
35	1	SEMTECH CORP	SRV05-4.TCT	U6
36	1	VISHAY INTERTECHNOLOGY	BAT54W-V-GS08	D18
37	2	FAIRCHILD	MMBT3904K	Q2,Q4
38	1	FAIRCHILD	MMBT3906K	Q3
39	1	CUI STACK	CCV-084B16	LS1
40	1	E SWITCH	TL1015BF160QG	SW10
41	1	LITE ON	LTST-C230TBKT	—

2.2.2 TSSEVB Silk Screen

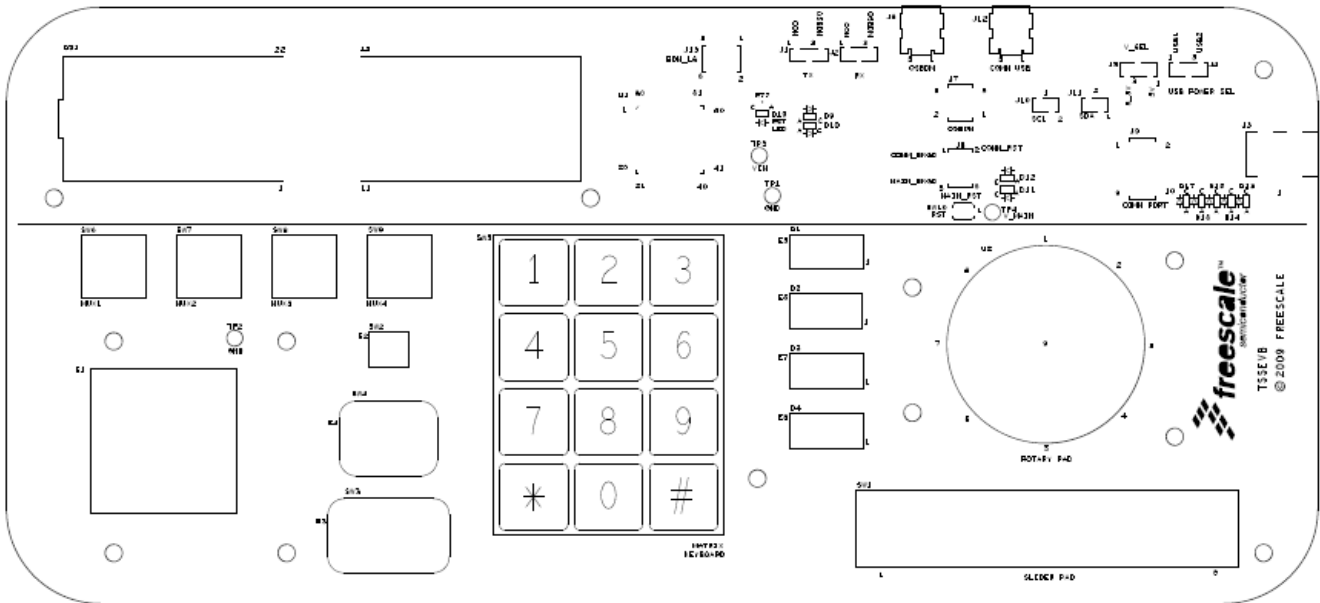

FREESCALE SEMICONDUCTOR		NAME	
4501 WILLICH COMMON DRIVE WEST		TSSEVB	
46073H, TEL: 617 9735 5000			
THIS DOCUMENT CONTAINS INFORMATION		— PUBL (PUBLIC INFORMATION)	
PROPRIETARY TO FREESCALE AND SHALL		— F310 (FREESCALE INTERNAL USE ONLY)	
NOT BE USED FOR ENGINEERING DESIGN		— FCP (FREESCALE CONFIDENTIAL PROPRIETARY)	
PROCUREMENT OR MANUFACTURE IN WHOLE			
OR IN PART WITHOUT THE CONSENT OF			
FREESCALE.			
SHEET	TECH	DATE	NUMBER
2 OF 8	PRIMARY SILKSCREEN	07-22-09	L70-26024 REV B

Figure 2-3. TSSEVB Silk Screen

2.3 Header and Jumper Connections

2.3.1 USB Power Selection

1. To supply power to the TSSEVB with the USB OSBDM source, place the jumper on 1–2 position.

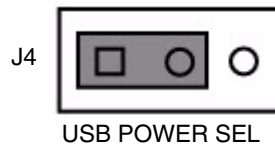

Figure 2-4. Jumper Placement for USB OSBDM Source

2. To supply power to the TSSEVB with the USB COMM source, place the jumper on 2–3 position.

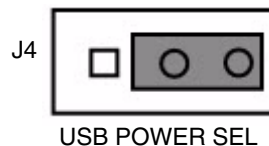

Figure 2-5. Jumper Placement for USB COMM Source

2.3.2 External Power Supply

External power supply can be applied to J3. A minimum of 6.25 V must be applied. When J3 is plugged, the USB power options are disabled.

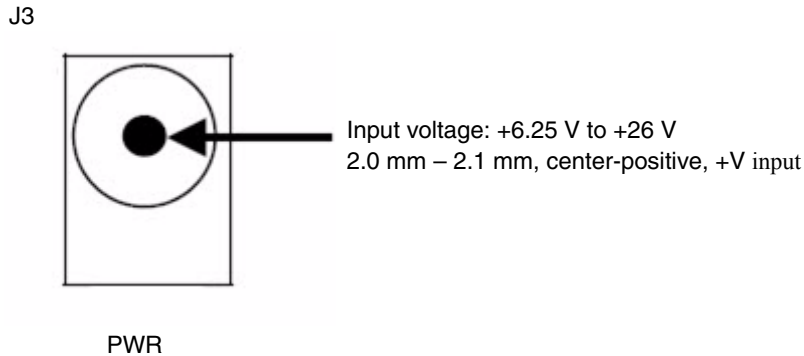

Figure 2-6. Jumper Placement for External Power Supply

2.3.3 Voltage Selection

The system can be operated at 5 V or 3.3 V. Place a jumper on J5 for voltage selection.

1. To supply 5 V to the TSSEVB, place the jumper on 1–2 position.

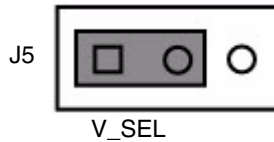

Figure 2-7. Jumper Placement for 5 V

2. To supply 3.3 V to the TSSEVB, place the jumper on 2–3 position.

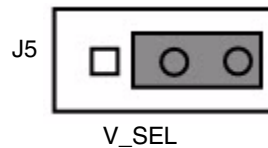
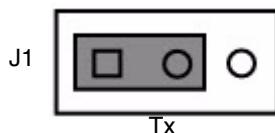

Figure 2-8. Jumper Placement for 3.3 V

2.3.4 MC9S08LG32 UART

The MC9S08LG32 MCU can communicate through the SCI protocol with the MC9S08JM60 Comm MCU or the OSBDM MCU. You can select the communication device placing a jumper on J1 for the MC9S08LG32 transmitter pin and J2 for the MC9S08LG32 receiver pin.

1. To select the MC9S08JM60 Comm MCU as communication device for the Tx SCI signal of the MC9S08LG32 MCU, place the jumper on position 1–2 on J1.



2. To select the OSBDM MCU as a communication device for the Tx SCI signal of the MC9S08LG32 MCU, place the jumper on position on 2-3 on J1.

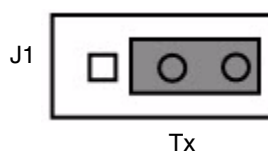

3. To select the MC9S08JM60 Comm MCU as a communication device for the Rx SCI signal of the MC9S08LG32 MCU, place the jumper on position 1-2 on J2.

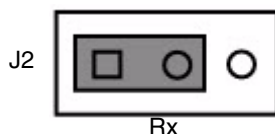

4. To select the MC9S08JM60 Comm MCU as a communication device for the Rx SCI signal of the MC9S08LG32 MCU, place the jumper on position 2-3 on J2.

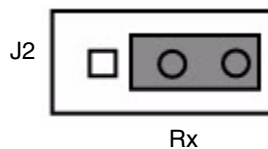

2.3.5 Test Points

TSSEVB includes several test points for electrical test. [Table 2-3](#) lists all the test points.

Table 2-3. Test Points on the TSSEVB

Test Point	Signal
TP1	GND test point
TP2	GND test point
TP3	V _{in} test point
TP4	V_Main test point

2.3.6 BDM Header

BDM has the ability to program either the MC9S08LG32 MCU or the MC9S08JM60 Comm MCU.

1. To choose the MC9S08LG32 MCU as a programming target, place jumpers on position 5–3 and 6–4 on J6.

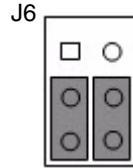

BDM Header

Figure 2-9. Jumper Placement for the MC9S08LG32 MCU

2. To choose the MC9S08JM60 Comm MCU as a programming target, place jumpers on position 3–1 and 4–2 on J6.

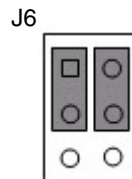

BDM Header

Figure 2-10. Jumper Placement for the MC9S08JM60 Comm MCU

2.3.7 Comm PORT

The communication port provides access to the communication modules of the MC9S08JM60 Comm MCU. [Table 2-4](#) shows the MC9S08JM60 Comm MCU peripherals.

Table 2-4. MC9S08JM60 Comm MCU Peripherals

MISO1	1	2	RX1
MOSI1	3	4	TX1
SPSCK1	5	6	SCL
SS1	7	8	SDA
VIN	9	10	GND

2.3.8 IIC Communication

When using the Electrode Graphing Tool, the communication between the MC9S08LG32 MCU and the MC9S08JM60 Comm MCU is required. The communication is achieved through the IIC module from each MCUs. J10 and J11 connect the IIC modules from both MCUs.

1. To connect the SCL signals of the MC9S08LG32 MCU and the MC9S08JM60 Comm MCU, place the jumper on J10.

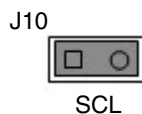

Figure 2-11. Jumper Placement for SCL Signals

2. To connect the SDA signals of the MC9S08LG32 MCU and the MC9S08JM60 Comm MCU, place the jumper on J11.

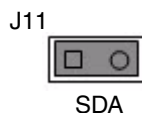

Figure 2-12. Jumper Placement for SDA Signals

2.3.8.1 Using the TSSEVB IIC Communication Module

You can use the TSSEVB board to monitor the capacitance variations on the electrodes from your application. The TSSEVB features a Communication MCU that communicates every TSS application with the Electrode Graphing Tool Software. This section discusses the steps required to use the TSSEVB communication module as a bridge between your application and the Electrode Graphing Tool (EGT) software.

2.3.8.1.1 Setting Up the Software

1. Add the EGT communication files to your application. To do so, you must follow the steps described in "Application Setup" section of the *Touch Sensing Software Electrode Graphing Tool Users Guide* (document TSSEGTUG).
2. To access the EGT communication files, first install the EGT software. After the software is installed, the EGT communication files can be found at the following path:

**C:\Program Files\Freescale\Electrode Graphing Tool x.x\Example\
TSSEVB_EGT_Example\Sources\EGT**

2.3.8.1.2 Setting Up the Hardware

This section describes the steps required to connect the TSS application to the TSSEVB Communication module.

1. Remove the jumpers located in connectors J10 (SCL) and J11 (SDA) from TSSEVB.
2. Select the appropriated voltage on connector J5 depending on the voltage supplied to your application.
3. Set the connector J4 jumper to position 2-3 (USB2).
4. Connect the I2C lines from your application to connector J10 and J11 as shown in [Figure 2-13](#). You must also have a ground (GND) connection between the TSS application hardware and the TSSEVB. The TSSEVB Communication module provides the pull-up resistors for the I2C communication.

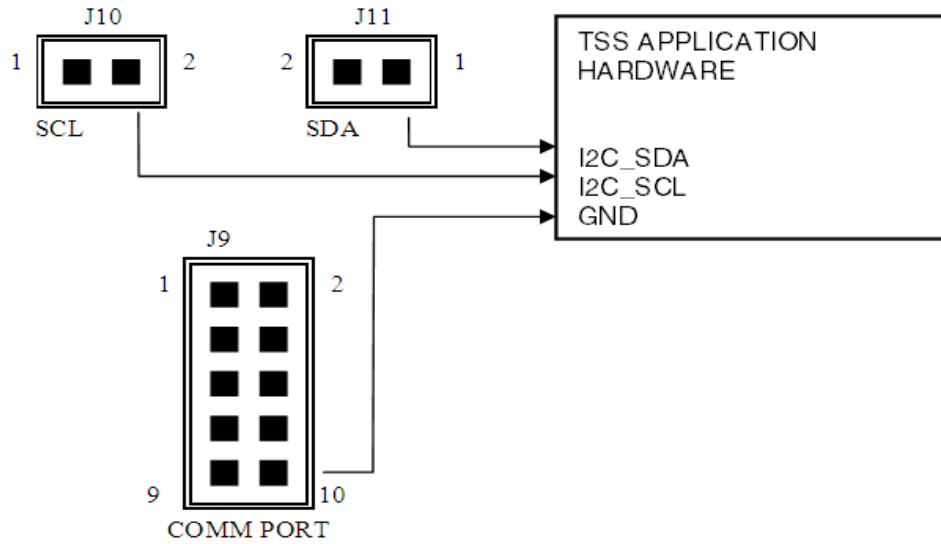

Figure 2-13. Connections Between the TSS Application Hardware and the TSSEVB Board

5. After you have set all the connections, turn on the TSS application hardware and the TSSEVB board, then launch the EGT software. The GUI should start showing the electrodes capacitance measurements. For more information regarding the use of the EGT software, refer to the *Touch Sensing Software Electrode Graphing Tool Users Guide* (document TSSEGTUG).

Chapter 3

TSSEVB Interfaces

3.1 MC9S08JM60 Comm MCU

TSSEVB includes a MC9S08JM60 Comm MCU that works as a bridge between MC9S08LG32 and the PC when using the EGT.

The MC9S08JM60 Comm MCU is loaded with the firmware that allows:

- Communication with the MC9S08LG32 microcontroller through the IIC protocol
- Communication with the PC through the USB protocol

TSSEVB offers the possibility to connect the MC9S08LG32 MCU with the MC9S08JM60 Comm MCU using the SCI module. In the communication port, all the communication modules of the MC9S08JM60 Comm MCU (SCI, IIC, and SPI) are mapped.

3.1.1 Re-Programming MC9S08JM60 Comm MCU on the TSSEVB

If the firmware loaded from factory of the MC9S08JM60 Comm MCU is lost or somehow corrupted, you can reload the firmware back into the MC9S08JM60 Comm MCU.

To re-program the MC9S08JM60 Comm MCU:

1. Ensure that you have installed the latest version of CodeWarrior Development Studio, available on the Freescale web site at www.freescale.com.
2. Download the latest version of the TSSEVB USB Bridge file from the Freescale web site at www.freescale.com/touchsensing.
3. Connect the PC to the MC9S08JM60 Comm MCU USB connector. To locate the MC9S08JM60 Comm MCU USB connector, refer to Section [Section 2.1.1](#).
4. Select the MC9S08JM60 Comm MCU as target of the OSBDM by setting jumpers on position 1–3 and 2–4 from connector J6 on the TSSEVB. [Figure 3-1](#) shows the required configuration of connector J6.

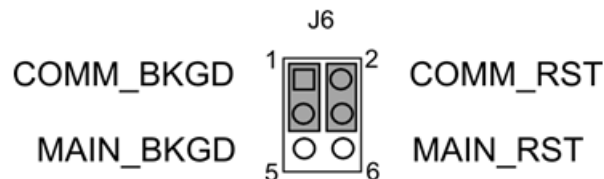

Figure 3-1. MC9S08JM60 Comm MCU programming configuration

5. Open the TSSEVB USB Bridge file using CodeWarrior Development Studio. From the CodeWarrior main menu, select **Project > Debug** to compile and download the firmware into the MC9S08JM60 Comm MCU.

3.2 IIC Interface

The MC9S08JM60 Comm MCU connects to the MC9S08LG32 MCU through the IIC protocol. The communication between the MC9S08JM60 Comm MCU and the MC9S08LG32 MCU is needed when you are using EGT. The MC9S08JM60 Comm MCU acts like a bridge between the MC9S08LG32 MCU with TSS and the PC. The MC9S08JM60 Comm MCU includes the firmware that allows communication with the MC9S08LG32 MCU. The TSSEVB board allows you to use the IIC module of the MC9S08JM60 Comm MCU for your own application. To do so, you must configure J10 and J11 jumpers from the TSSEVB board and you can connect with the IIC module of the MC9S08JM60 Comm MCU module through the communication header.

3.3 USB Interface

When the MC9S08JM60 Comm MCU is acting like a bridge, it communicates with the PC using the USB protocol. The bridge program is loaded to the MC9S08JM60 Comm MCU by default, but the MC9S08JM60 Comm MCU can be re-programmed using the OSBDM and the appropriate jumper configuration on the TSSEVB board. The MC9S08JM60 Comm MCU uses the USB module of MC9S08JM to achieve the communication with the PC.

3.4 SCI Interface

The MC9S08JM60 Comm MCU can communicate with MC9S08LG32 through the Serial Communication Interface (SCI) protocol. To connect both MCUs, configure the jumpers on header J1 and J2 respectively. The communication through SCI is not currently implemented and may be used in a future demo application.

3.5 OSBDM MCU

An Open Source Background Debug Module (OSBDM) interface is available on TSSEVB. The OSBDM interfaces to the MCU, which provides an interface for programming the on-chip flash. The BDM connector provides the ability to connect a debug interface for development and accessing memory data. The BDM has the ability to program MC9S08LG32 or the MC9S08JM60 Comm MCU on the board. This is accomplished by setting the J6 connectors appropriately. The BDM interface can also be used for traditional debugging. Debugging is accomplished using the CodeWarrior IDE for HCS08.

3.6 Additional BDM Connector for MC9S08LG32

The connector for an external BDM is also included in the TSSEVB board. This enables you to use an external BDM to program MC9S08LG32. To enable the external BDM, leave the jumpers on J6 either disconnected, or connected to the Communications MCU between 1-3 and 2-4.