

Base strip - DFK-MSTB 2,5/ 8-G-5,08 - 0707057

Please be informed that the data shown in this PDF Document is generated from our Online Catalog. Please find the complete data in the user's documentation. Our General Terms of Use for Downloads are valid (<http://download.phoenixcontact.com>)



Plug component, Nominal current: 12 A, Rated voltage (III/2): 320 V, Number of positions: 8, Pitch: 5.08 mm, Connection method: Solder/Slip-on connection, Color: green, Contact surface: Tin, Assembly: Direct mounting, Accessory order no. 5030172 can only be used in conjunction with MSTB 2,5/...ST-5,08 and MSTBT 2,5/...ST-5,08.

The illustration shows a 16-position version

Why buy this product

- Outside: plug-in connection for corresponding MSTB 2,5 or FKC 2,5 plugs
- Can be fixed in housing panels up to 6 mm thick using two M3 x 10 screws
- Inside: solder or 2.8 mm slip-on plug-in connection that can be combined
- Headers for assembly in a device/housing panel



Key commercial data

Packing unit	1
Minimum order quantity	50
Catalog page	Page 324 (CC-2011)
GTIN	 4 017918 003838
Custom tariff number	85366990
Country of origin	GERMANY

Technical data

Dimensions / positions

Pitch	5.08 mm
Dimension a	35.56 mm
Number of positions	8

Technical data

Range of articles	DFK-MSTB 2,5/..-G
Insulating material group	I
Rated surge voltage (III/3)	4 kV
Rated surge voltage (III/2)	4 kV
Rated surge voltage (II/2)	4 kV
Rated voltage (III/2)	320 V

Base strip - DFK-MSTB 2,5/ 8-G-5,08 - 0707057

Technical data

Technical data

Rated voltage (II/2)	630 V
Connection in acc. with standard	EN-VDE
Nominal current I _N	12 A
Nominal voltage U _N	320 V
Nominal cross section	2.5 mm ²
Maximum load current	12 A
Insulating material	PA
Inflammability class according to UL 94	V2
Nominal voltage, UL/CUL Use Group B	300 V
Nominal current, UL/CUL Use Group B	15 A
Nominal voltage, UL/CUL Use Group D	300 V
Nominal current, UL/CUL Use Group D	15 A

Connection data

Conductor cross section solid min.	0.2 mm ²
Conductor cross section solid max.	2.5 mm ²
Conductor cross section stranded min.	0.2 mm ²
Conductor cross section stranded max.	2.5 mm ²
Conductor cross section AWG/kcmil min.	24
Conductor cross section AWG/kcmil max	12

Classifications

eclass

eCl@ss 4.0	272607xx
eCl@ss 4.1	27260701
eCl@ss 5.0	27260701
eCl@ss 5.1	27141190
eCl@ss 6.0	27260704
eCl@ss 7.0	27440402

etim

ETIM 3.0	EC001283
ETIM 4.0	EC001283
ETIM 5.0	EC001283

unspsc

UNSPSC 6.01	30211810
UNSPSC 7.0901	39121409
UNSPSC 11	39121409
UNSPSC 12.01	39121409
UNSPSC 13.2	39121409

Base strip - DFK-MSTB 2,5/ 8-G-5,08 - 0707057

Approvals

Approvals

Approvals

CSA / UL Recognized / VDE report with production monitoring / cUL Recognized / GOST / IEC CB Scheme / GOST / cULus Recognized

Ex Approvals

Approvals submitted

Approval details

CSA 		
	B	D
Nominal current I _N	10 A	10 A
Nominal voltage U _N	300 V	300 V

UL Recognized 		
	B	D
Nominal current I _N	15 A	15 A
Nominal voltage U _N	300 V	150 V

VDE report with production monitoring 		
Nominal current I _N	12 A	
Nominal voltage U _N	250 V	

cUL Recognized 		
	B	D
Nominal current I _N	15 A	15 A
Nominal voltage U _N	300 V	150 V

Base strip - DFK-MSTB 2,5/ 8-G-5,08 - 0707057

Approvals



IECEE CB Scheme

Nominal current I _N	12 A
Nominal voltage U _N	250 V

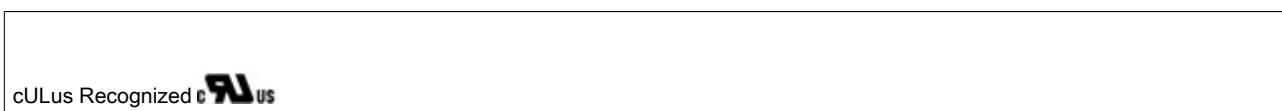

Accessories

Accessories

Assembly

Screw set - DFK-MSTB-SS - 0708263



Screw set, for securing the header to the device wall, consists of an M3 x 10 screw, with a spring washer and a nut

Accessories - MSTB-BL - 1755477



Keying cap, for forming sections, plugs onto header pin, green insulating material

Base strip - DFK-MSTB 2,5/ 8-G-5,08 - 0707057

Accessories

Accessories - DFK-MSTB-R - 5030172



Locking latch, red insulating material, for housings MSTB 2.5/...ST and MSTBT 2.5/...ST

Plug/Adapter

Keying star - CR-MSTB - 1734401



Coding section, inserted into the recess in the header or the inverted plug, red insulating material

Additional products

Printed-circuit board connector - MSTB 2,5/ 8-ST-5,08 - 1757077



Plug component, Nominal current: 12 A, Rated voltage (III/2): 320 V, Number of positions: 8, Pitch: 5.08 mm, Connection method: Screw connection, Color: green, Contact surface: Tin

Printed-circuit board connector - MSTB 2,5/ 8-STZ-5,08 - 1764235



Plug component, Nominal current: 12 A, Rated voltage (III/2): 320 V, Number of positions: 8, Pitch: 5.08 mm, Connection method: Screw connection, Color: green, Contact surface: Tin

Printed-circuit board connector - FRONT-MSTB 2,5/ 8-ST-5,08 - 1777345



Plug component, Nominal current: 12 A, Rated voltage (III/2): 320 V, Number of positions: 8, Pitch: 5.08 mm, Connection method: Screw connection, Color: green, Contact surface: Tin

Base strip - DFK-MSTB 2,5/ 8-G-5,08 - 0707057

Accessories

Base strip - ICV 2,5/ 8-G-5,08 - 1786006



Header, Nominal current: 12 A, Rated voltage (III/2): 320 V, Number of positions: 8, Pitch: 5.08 mm, Color: green, Contact surface: Tin, Assembly: Soldering

Base strip - IC 2,5/ 8-G-5,08 - 1786462



Header, Nominal current: 12 A, Rated voltage (III/2): 320 V, Number of positions: 8, Pitch: 5.08 mm, Color: green, Contact surface: Tin, Assembly: Soldering

Plug - MSTBT 2,5/ 8-ST-5,08 - 1781043



Plug component, Nominal current: 12 A, Rated voltage (III/2): 320 V, Number of positions: 8, Pitch: 5.08 mm, Connection method: Screw connection, Color: green, Contact surface: Tin

Printed-circuit board connector - MVSTBW 2,5/ 8-ST-5,08 - 1792812



Plug component, Nominal current: 12 A, Rated voltage (III/2): 320 V, Number of positions: 8, Pitch: 5.08 mm, Connection method: Screw connection, Color: green, Contact surface: Tin

Printed-circuit board connector - SMSTB 2,5/ 8-ST-5,08 - 1826348



Plug component, Nominal current: 12 A, Rated voltage (III/2): 320 V, Number of positions: 8, Pitch: 5.08 mm, Connection method: Screw connection, Color: green, Contact surface: Tin

Base strip - A-ICV 2,5/ 8-G-5,08 - 1872758



Base strip, Nominal current: 12 A, Nominal voltage: 250 V, Mounting type: DIN rail mounting, Number of positions: 8, Pitch: 5.08 mm, Color: green

Base strip - DFK-MSTB 2,5/ 8-G-5,08 - 0707057

Accessories

Printed-circuit board connector - TMSTBP 2,5/ 8-ST-5,08 - 1853078



Plug component, Nominal current: 12 A, Rated voltage (III/2): 320 V, Number of positions: 8, Pitch: 5.08 mm, Connection method: Screw connection, Color: green, Contact surface: Tin, The plug allows conductors to be looped through from module to module.

Printed-circuit board connector - FKCVR 2,5/ 8-ST-5,08 - 1874015

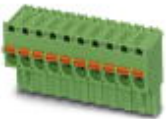

Plug component, Nominal current: 12 A, Rated voltage (III/2): 320 V, Number of positions: 8, Pitch: 5.08 mm, Connection method: Spring-cage conn., Color: green, Contact surface: Tin

Printed-circuit board connector - FKC 2,5/ 8-ST-5,08 - 1873113



Plug component, Nominal current: 12 A, Rated voltage (III/2): 320 V, Number of positions: 8, Pitch: 5.08 mm, Connection method: Spring-cage conn., Color: green, Contact surface: Tin

Printed-circuit board connector - MSTBC 2,5/ 8-ST-5,08 - 1808874



Plug component, Nominal current: 12 A, Rated voltage (III/2): 320 V, Number of positions: 8, Pitch: 5.08 mm, Connection method: Crimp connection, Color: green, Corresponding female crimp contacts with current [A] and conductor cross section range [mm²] data: 10A/MSTBC-MT 0,5-1,0 (3190564); 10A/MSTBC-MT 0,5-1,0 BA (3190645); 12A/MSTBC-MT 1,5-2,5 (3190551); 12A/MSTBC-MT 1,5-2,5 BA (3190658). BA = Bandkontakte

Printed-circuit board connector - MVSTBR 2,5/ 8-ST-5,08 - 1792304



Plug component, Nominal current: 12 A, Rated voltage (III/2): 320 V, Number of positions: 8, Pitch: 5.08 mm, Connection method: Screw connection, Color: green, Contact surface: Tin

Base strip - DFK-MSTB 2,5/ 8-G-5,08 - 0707057

Accessories

Printed-circuit board connector - MSTBP 2,5/ 8-ST-5,08 - 1769078



Plug component, Nominal current: 12 A, Rated voltage (III/2): 320 V, Number of positions: 8, Pitch: 5.08 mm, Connection method: Screw connection, Color: green, Contact surface: Tin

Printed-circuit board connector - MSTBC 2,5/ 8-STZ-5,08 - 1809569



Plug component, Nominal current: 12 A, Rated voltage (III/2): 320 V, Number of positions: 8, Pitch: 5.08 mm, Connection method: Crimp connection, Color: green, Corresponding female crimp contacts with current [A] and conductor cross section range [mm²] data: 10A/MSTBC-MT 0,5-1,0 (3190564); 10A/MSTBC-MT 0,5-1,0 BA (3190645); 12A/MSTBC-MT 1,5-2,5 (3190551); 12A/MSTBC-MT 1,5-2,5 BA (3190658). BA = Bandkontakte

Printed-circuit board connector - FKCVW 2,5/ 8-ST-5,08 - 1873715



Plug component, Nominal current: 12 A, Rated voltage (III/2): 320 V, Number of positions: 8, Pitch: 5.08 mm, Connection method: Spring-cage conn., Color: green, Contact surface: Tin

Printed-circuit board connector - QC 1/ 8-ST-5,08 - 1883310

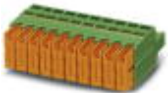

Plug component, Nominal current: 10 A, Rated voltage (III/2): 630 V, Number of positions: 8, Pitch: 5.08 mm, Connection method: Insulation displacement connection QUICKON, Color: green, Contact surface: Tin

Printed-circuit board connector - FKCT 2,5/ 8-ST-5,08 - 1902178



Plug component, Nominal current: 12 A, Rated voltage (III/2): 320 V, Number of positions: 8, Pitch: 5.08 mm, Connection method: Spring-cage conn., Color: green, Contact surface: Tin

Drawings

Base strip - DFK-MSTB 2,5/ 8-G-5,08 - 0707057

Drilling diagram

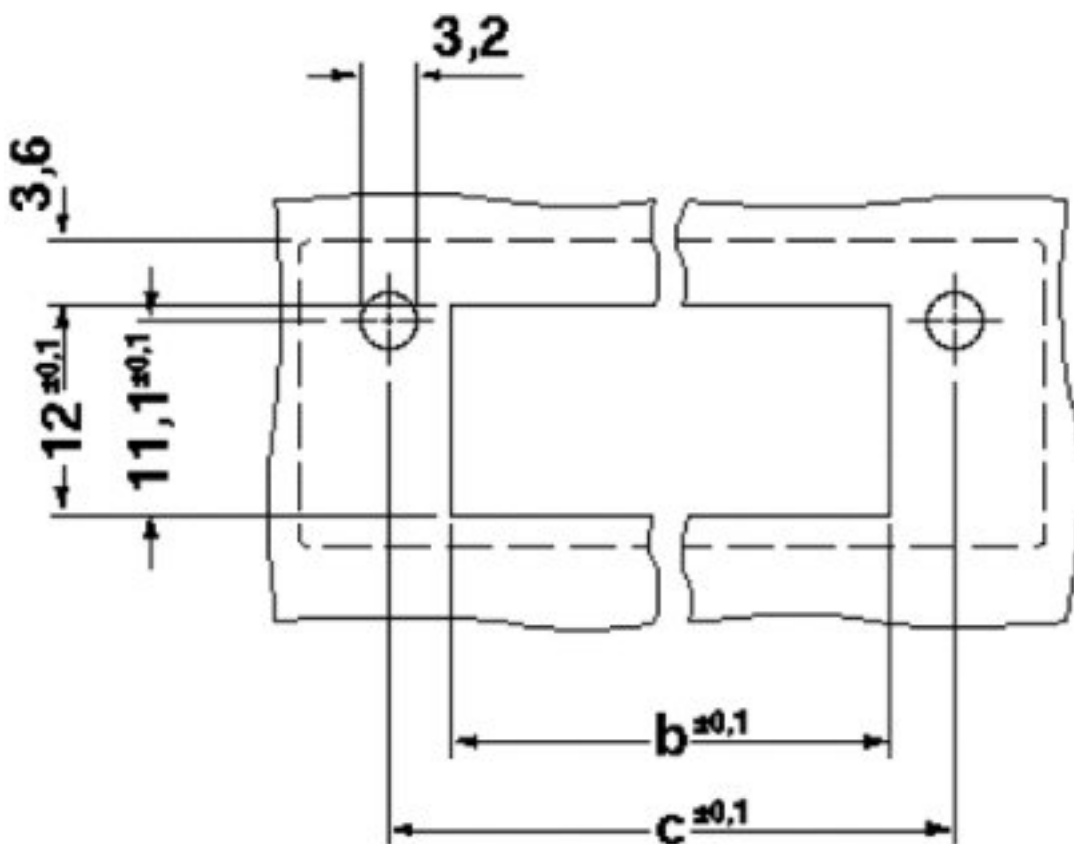

Dimensioned drawing

