



Agency Approvals

AGENCY	AGENCY FILE NUMBER
	E128662

2 Electrode GDT Graphical Symbol



Additional Information



Datasheet



Resources



Samples

Description

Littelfuse SE series GDT offers high surge ratings in a miniature package. It's designed for surface mounting on PCB with small size 3.2x1.6x1.6mm. Low insertion loss is perfectly suited to broadband equipment applications. The capacitance does not vary with voltage, and will not cause operational problems with ADSL2+, where capacitance variation across Tip and Ring is undesirable. These devices are extremely robust and are able to divert a 500A-600A pulse in a miniature package 1206 without destruction.

Features

- RoHS compliant and Lead-free
- GHz working frequency
- Excellent stability on multiple pulse duty cycle
- Excellent response to fast rising transients.
- Ultra Low Insertion Loss
- 0.5-0.6KA surge capability tested with 8/20 μ S pulse as defined by IEC 61000-4-5
- Ultra small devices offered in a variety of mounting lead forms
- Non-Radioactive
- Low capacitance (<0.5pF)
- Voltage Ranges 140V to 500V
- UL recognized
- Conforms to ITU-T K12, IEC 1000-4-5
- Square Outline

Applications

- Communication equipment
- CATV equipment
- Test equipment
- Data lines
- Power supplies
- Telecom SLIC protection
- Broadband equipment
- ADSL equipment, including ADSL2+
- XDSL equipment
- Satellite and CATV equipment
- General telecom equipment

Electrical Characteristics

Part Number	Device Specifications (at 25°C)										Life Ratings	
	DC Breakdown in Volts (@100V/s)			Impulse Breakdown in Volts (@100V/μs)	Impulse Breakdown In Volts (@1 Kv/μsec)	Insulation Resistance	Capacitance (@1MHz)	Arc Voltage (@1A)	Glow to Arc Transition Current	Glow Voltage	Nominal Impulse Discharge Current (x10 @3/20μs)	Nominal Impulse Discharge Current (x10 @5/320μs)
	MIN	TYP	MAX									
SE140	98	140	182	800	900	>1GΩ (at 100VDC)	<0.5 pf	~10 V	<1.0 A	~60 V	0.5 kA	150 A
SE200	140	200	260	700	1100		<0.3 pf		<1.0 A			
SE230	172	230	276	600	800		<0.5 pf		<1.0 A			
SE350	265	350	495	900	1150		<0.5 pf		<1.0 A			
SE470	329	470	611	1050	1200		<0.3 pf		<1.0 A			
SE500	400	500	600	1050	1200		<0.3 pf		<1.0 A			

Product Characteristics

Materials	Device Tin Plated 17.5±12.5 Microns Construction Ceramic Insulator.
Storage and Operational Temperature	-40 to +90 °C

Voltage vs. Time Characteristic

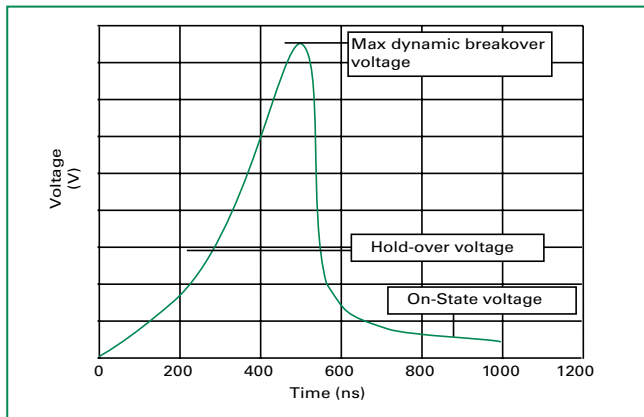

Tape and Reel Dimensions (IEC 60286-3, dimension in mm)

Tape Specifications

IEC 60286-3
Dimensions in mm

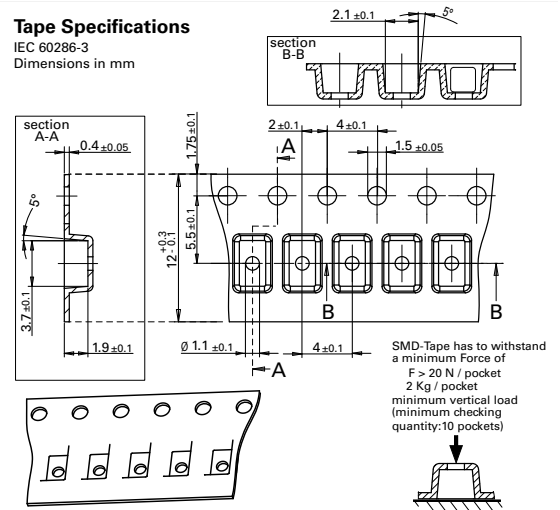

Reel Specifications

IEC 60286-3
Dimensions in mm

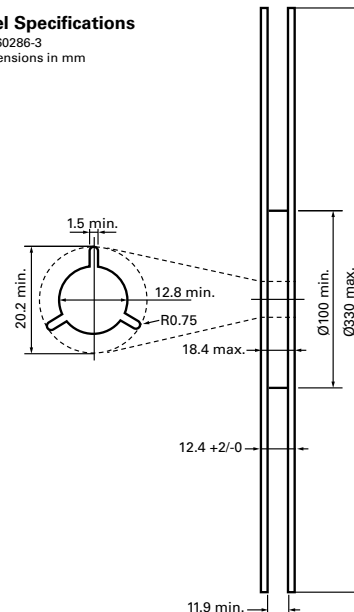

Soldering Parameters - Reflow Soldering (Surface Mount Devices)

Reflow Condition		Pb – Free assembly
Pre Heat	- Temperature Min ($T_{s(min)}$)	150°C
	- Temperature Max ($T_{s(max)}$)	200°C
	- Time (Min to Max) (t_s)	60 – 180 secs
Average ramp up rate (Liquidus Temp (T_L) to peak)		3°C/second max
$T_{s(max)}$ to T_L - Ramp-up Rate		5°C/second max
Reflow	- Temperature (T_L) (Liquidus)	217°C
	- Temperature (t_L)	60 – 150 seconds
Peak Temperature (T_p)		260 ^{+0/-5} °C
Time within 5°C of actual peak Temperature (t_p)		10 – 30 seconds
Ramp-down Rate		6°C/second max
Time 25°C to peak Temperature (T_p)		8 minutes Max.
Do not exceed		260°C

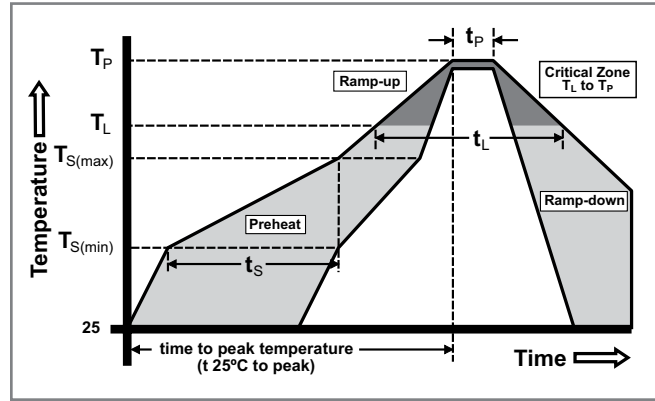

Device Dimensions

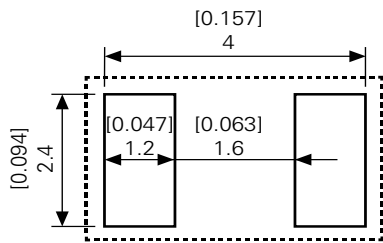
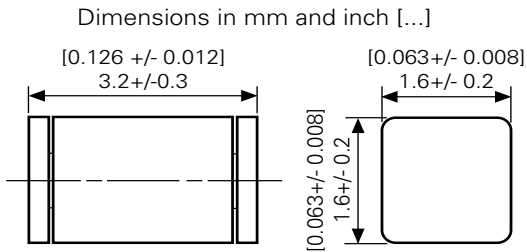

Recommended Pad Layout

Part Numbering System and Ordering Information

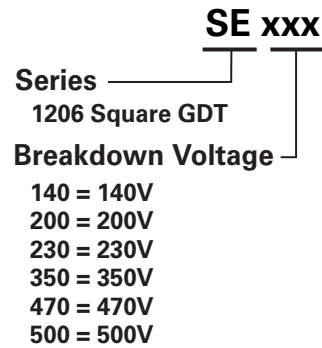

Packaging

Part Number	Packaging Option	Quantity
SE140	Tape and Reel	3,000
SE200	Tape and Reel	3,000
SE230	Tape and Reel	3,000
SE350	Tape and Reel	3,000
SE470	Tape and Reel	3,000
SE500	Tape and Reel	3,000