



# SAW Components

Data Sheet B7701





**SAW Components**

**B7701**

**Low-Loss Filter for Mobile Communication**

**881,5 MHz**

Data Sheet



**Features**

- Low-loss RF filter for mobile telephone AMPS system, receive path
- Low amplitude ripple
- Usable passband 25 MHz
- Unbalanced to balanced operation
- Impedance transformation from 50 Ω to 200 Ω
- Suitable for GPRS class 1 to 12
- Package for **Surface Mounted Technology (SMT)**

**Chip Sized SAW Package QCS5A**

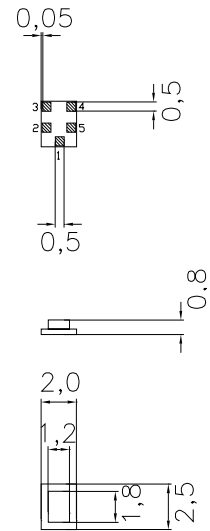

Dimensions in mm, approx. weight 0,015g

**Terminals**

- Ni, gold-plated

**Pin configuration**

- 1                    Input
- 3, 4                Balanced output
- 2, 5                Ground, to be grounded

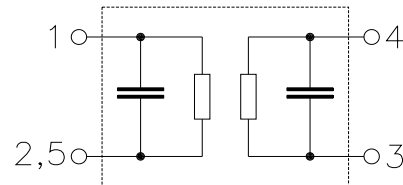

Type	Ordering code	Marking and Package according to	Packing according to
B7701	B39881-B7701-B610	C61157-A7-A71	F61074-V8104-Z000

Electrostatic Sensitive Device (ESD)

**Maximum ratings**

Operable temperature range	$T$	- 40 / + 85	°C	peak power of GSM signal, duty cycle 4:8
Storage temperature range	$T_{stg}$	- 40 / + 85	°C	
DC voltage	$V_{DC}$	5	V	
Input power at GSM850, GSM900, GSM1800 and GSM1900 Tx bands	$P_{IN}$	15	dBm	



SAW Components

B7701

Low-Loss Filter for Mobile Communication

881,5 MHz

Data Sheet



**Characteristics**

Operating temperature range:  $T = +25\text{ °C}$   
 Terminating source impedance:  $Z_S = 50\ \Omega$   
 Terminating load impedance:  $Z_L = 200\ \Omega$

		min.	typ.	max.	
<b>Center frequency</b>	$f_C$	—	881,5	—	MHz
<b>Maximum insertion attenuation</b>	$\alpha_{max}$				
869,0 ... 894,0 MHz		—	2,3	2,6	dB
<b>Amplitude ripple (p-p)</b>	$\Delta\alpha$				
869,0 ... 894,0 MHz		—	0,6	1,0	dB
<b>VSWR</b>					
869,0 ... 894,0 MHz		—	1,8	2,0	
<b>Output phase balance (<math>\phi(S_{31}) - \phi(S_{32}) + 180^\circ</math>)</b>					
869,0 ... 894,0 MHz		-10,0	0	10,0	degree
<b>Output amplitude balance (<math> S_{31}/S_{32} </math>)</b>					
869,0 ... 894,0 MHz		-1,0	0	1,0	dB
<b>Attenuation</b>	$\alpha$				
0,0 ... 824,0 MHz		50,0	60,0	—	dB
824,0 ... 849,0 MHz		35,0	40,0	—	dB
914,0 ... 924,0 MHz		25,0	28,0	—	dB
924,0 ... 970,0 MHz		30,0	36,0	—	dB
970,0 ... 3000,0 MHz		50,0	70,0	—	dB
3000,0 ... 6000,0 MHz		45,0	60,0	—	dB
<b>Tx band suppression</b>	$\alpha$				
824,0 ... 849,0 MHz		35,0	40,0	—	dB



SAW Components

B7701

Low-Loss Filter for Mobile Communication

881,5 MHz

Data Sheet



**Characteristics**

Operating temperature range:  $T = -30$  to  $+85$  °C  
 Terminating source impedance:  $Z_S = 50 \Omega$   
 Terminating load impedance:  $Z_L = 200 \Omega$

		min.	typ.	max.	
<b>Center frequency</b>	$f_C$	—	881,5	—	MHz
<b>Maximum insertion attenuation</b>	$\alpha_{max}$				
	869,0 ... 894,0 MHz	—	2,6	3,0	dB
<b>Amplitude ripple (p-p)</b>	$\Delta\alpha$				
	869,0 ... 894,0 MHz	—	1,0	1,4	dB
<b>VSWR</b>					
	869,0 ... 894,0 MHz	—	1,8	2,0	
<b>Output phase balance (<math>\phi(S_{31}) - \phi(S_{32}) + 180^\circ</math>)</b>					
	869,0 ... 894,0 MHz	-10,0	0	10,0	degree
<b>Output amplitude balance (<math> S_{31}/S_{32} </math>)</b>					
	869,0 ... 894,0 MHz	-1,0	0	1,0	dB
<b>Attenuation</b>	$\alpha$				
	0,0 ... 824,0 MHz	50,0	60,0	—	dB
	824,0 ... 849,0 MHz	35,0	40,0	—	dB
	914,0 ... 924,0 MHz	22,0	26,0	—	dB
	924,0 ... 970,0 MHz	30,0	36,0	—	dB
	970,0 ... 3000,0 MHz	50,0	70,0	—	dB
	3000,0 ... 6000,0 MHz	45,0	60,0	—	dB
<b>Tx band suppression</b>	$\alpha$				
	824,0 ... 849,0 MHz	35,0	40,0	—	dB



SAW Components

B7701

Low-Loss Filter for Mobile Communication

881,5 MHz

Data Sheet



**Characteristics**

Operating temperature range:  $T = -40$  to  $+85$  °C  
 Terminating source impedance:  $Z_S = 50 \Omega$   
 Terminating load impedance:  $Z_L = 200 \Omega$

		min.	typ.	max.	
<b>Center frequency</b>	$f_C$	—	881,5	—	MHz
<b>Maximum insertion attenuation</b>	$\alpha_{max}$				
	869,0 ... 894,0 MHz	—	2,6	3,1	dB
<b>Amplitude ripple (p-p)</b>	$\Delta\alpha$				
	869,0 ... 894,0 MHz	—	1,0	1,5	dB
<b>VSWR</b>					
	869,0 ... 894,0 MHz	—	1,8	2,2	
<b>Output phase balance (<math>\phi(S_{31}) - \phi(S_{32}) + 180^\circ</math>)</b>					
	869,0 ... 894,0 MHz	-10,0	0	10,0	degree
<b>Output amplitude balance (<math> S_{31}/S_{32} </math>)</b>					
	869,0 ... 894,0 MHz	-1,0	0	1,0	dB
<b>Attenuation</b>	$\alpha$				
	0,0 ... 824,0 MHz	50,0	60,0	—	dB
	824,0 ... 849,0 MHz	35,0	40,0	—	dB
	914,0 ... 924,0 MHz	22,0	26,0	—	dB
	924,0 ... 970,0 MHz	30,0	36,0	—	dB
	970,0 ... 3000,0 MHz	50,0	70,0	—	dB
	3000,0 ... 6000,0 MHz	45,0	60,0	—	dB
<b>Tx band suppression</b>	$\alpha$				
	824,0 ... 849,0 MHz	35,0	40,0	—	dB



Transfer function (narrowband measurement)

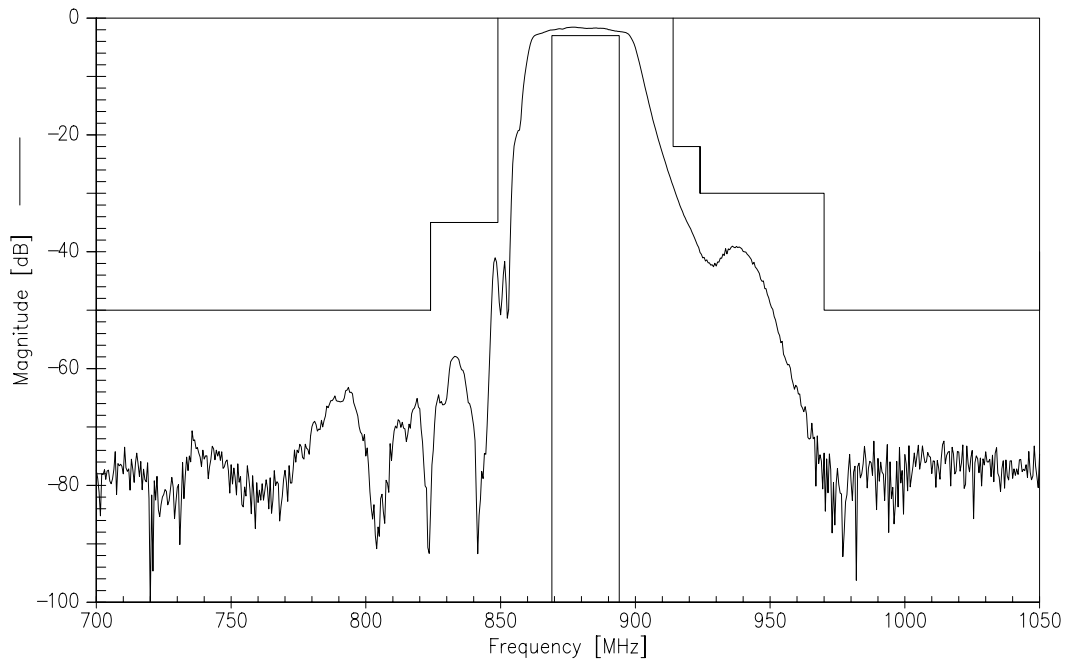

Transfer function (wideband measurement)

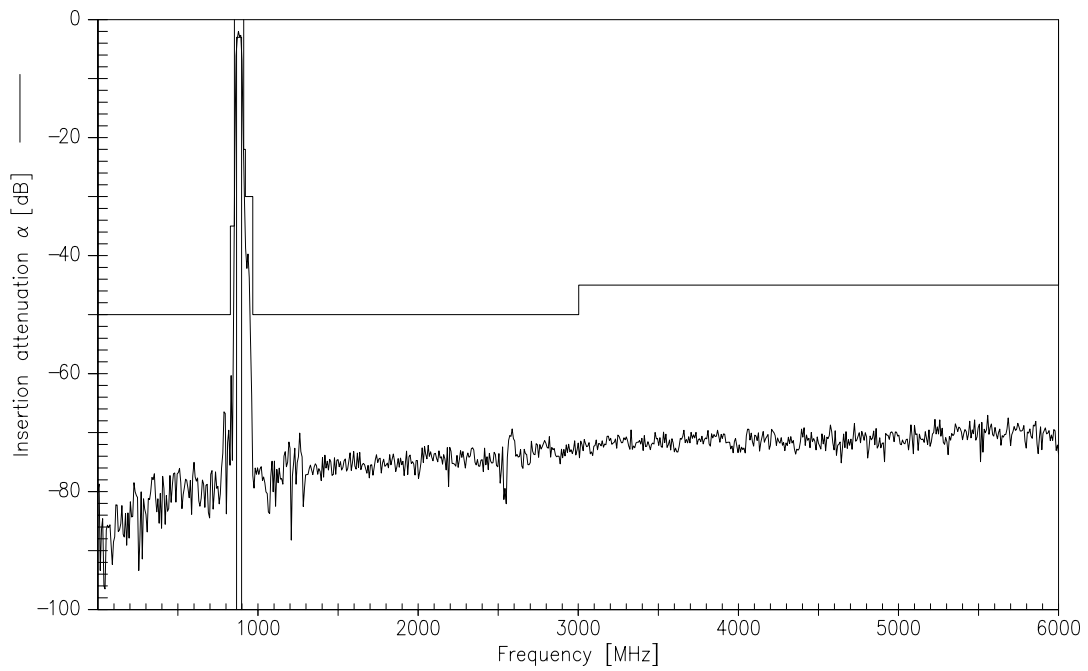



Reflection functions (measurement)

$S_{11}$

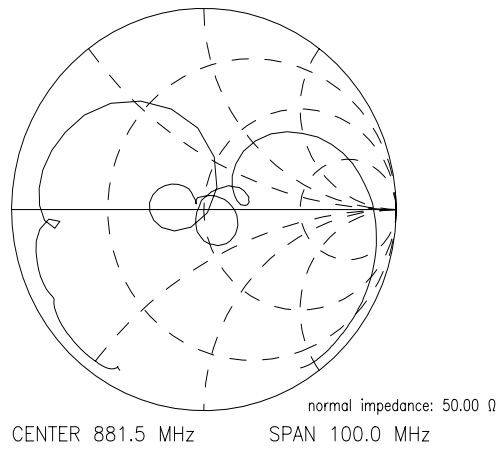
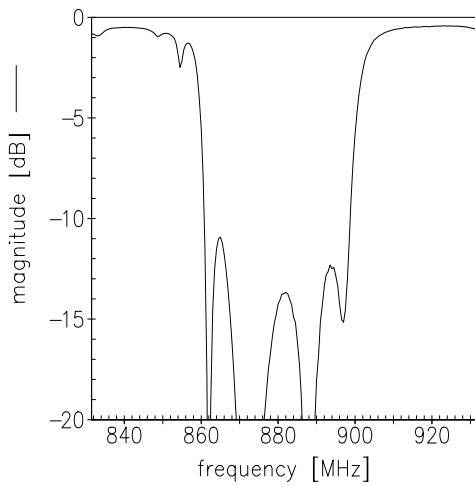

$S_{22}$

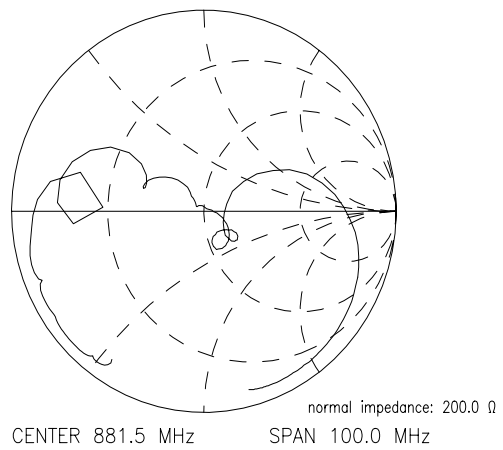
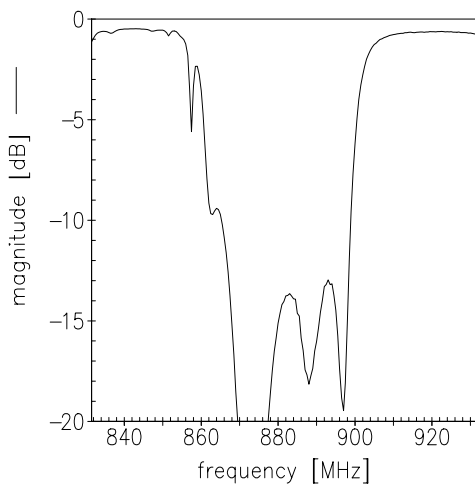



Output amplitude balance ( $|S_{31}/S_{21}|$ ; measurement)

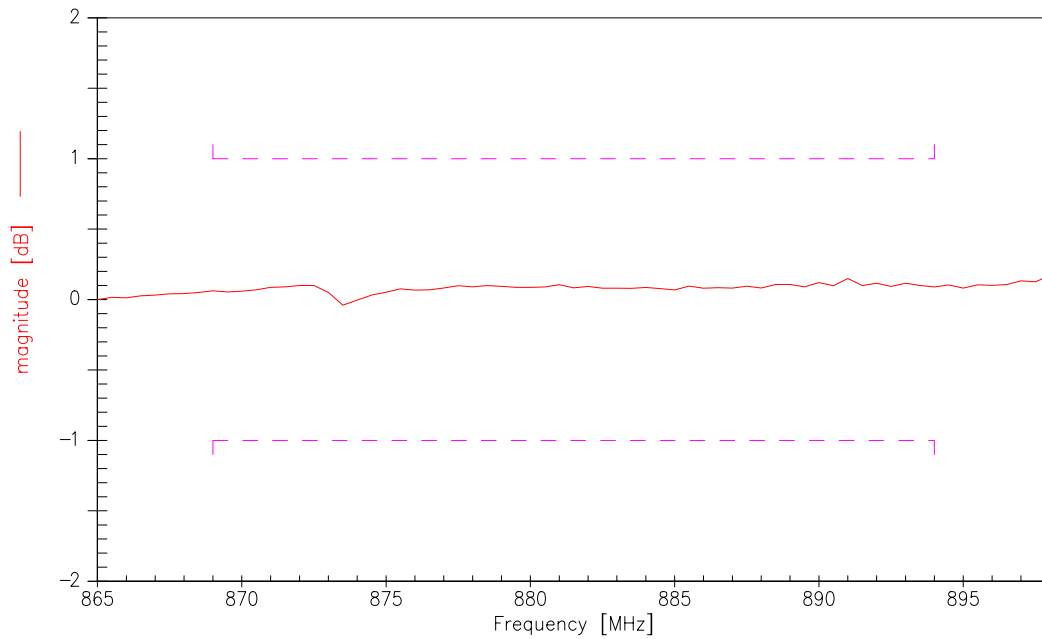

Output phase balance ( $\phi(S_{31})-\phi(S_{21})+180^\circ$ ; measurement)

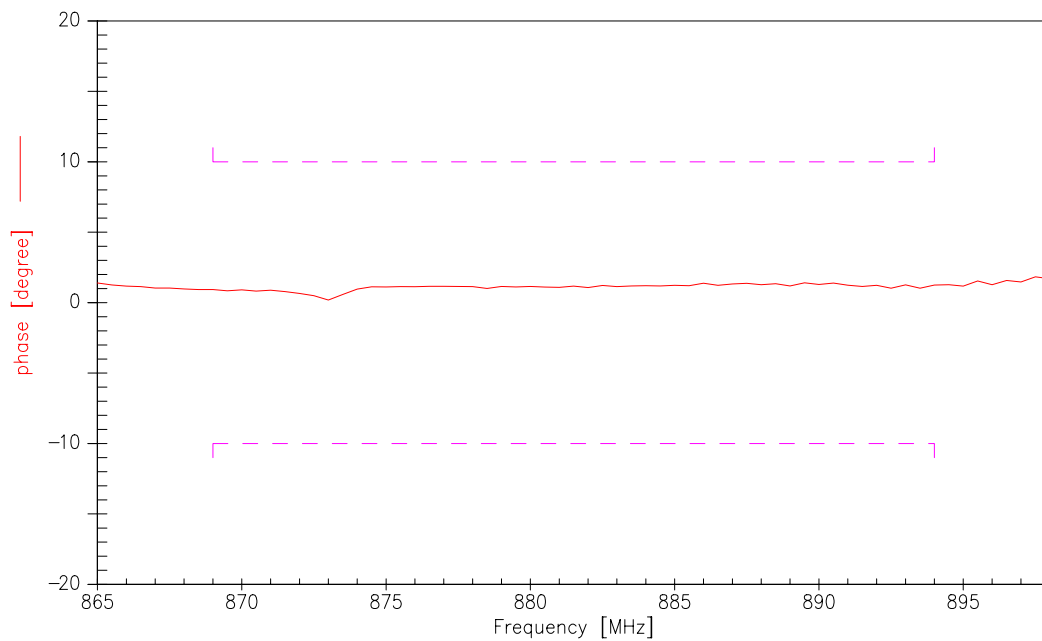





**SAW Components**

**B7701**

**Low-Loss Filter for Mobile Communication**

**881,5 MHz**

Data Sheet



**Published by EPCOS AG**

**Surface Acoustic Wave Components Division, SAW MC WT**

**P.O. Box 80 17 09, 81617 Munich, GERMANY**

© EPCOS AG 2002. Reproduction, publication and dissemination of this brochure and the information contained therein without EPCOS' prior express consent is prohibited.

Purchase orders are subject to the General Conditions for the Supply of Products and Services of the Electrical and Electronics Industry recommended by the ZVEI (German Electrical and Electronic Manufacturers' Association), unless otherwise agreed.

This brochure replaces the previous edition.

For questions on technology, prices and delivery please contact the Sales Offices of EPCOS AG or the international Representatives.

Due to technical requirements components may contain dangerous substances. For information on the type in question please also contact one of our Sales Offices.