

NA1-11

Related Information

- General terms and conditions..... F-7
- Sensor selection guideP.885~
- Glossary of terms..... P.1455~
- General precautions P.1458~

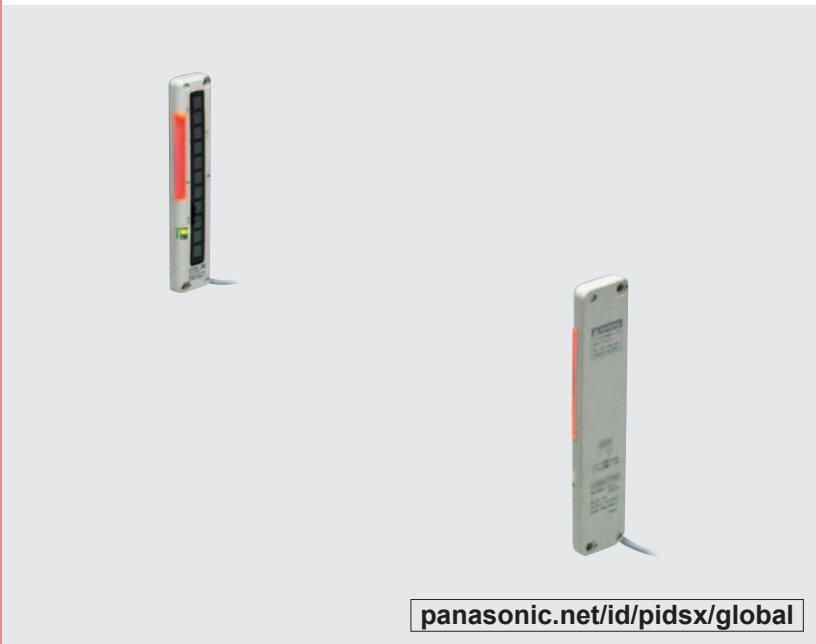

panasonic.net/id/pidsx/global



Make sure to use light curtains when using a sensing device for personnel protection. Refer to p.495~ for details of light curtains.



Cross-beam scanning system to detect slim objects

Letters or business cards detectable!

Slim objects can be detected by the cross-beam scanning system.

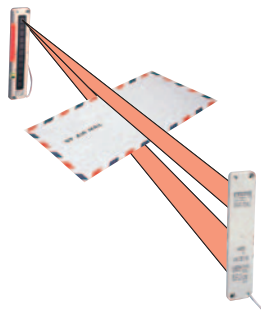

Emitting and receiving element pitch: 10 mm 0.394 in

A minimum sensing object size of $\phi 13.5$ mm $\phi 0.531$ in can be detected by an emitting and receiving element pitch of 10 mm 0.394 in.

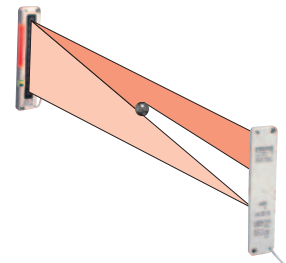

Wide area

Though being extremely slim, it has a wide sensing area of 1 m 3.281 ft length and 100 mm 3.937 in width. It is most suitable for object detection on a wide assembly line, or for detecting the dropping of, or incursion by, small objects whose travel path is uncertain.

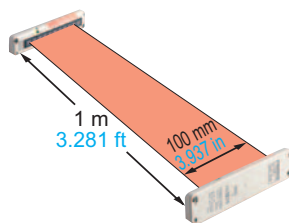

Just 10 mm 0.394 in thick

It is extremely slim, being just 10 mm 0.394 in thick. Further, it can be mounted in a narrow space as you can select from two cable orientation directions.



It is possible to select from two cable orientation directions.

Globally usable

It conforms to the EMC Directive and the UL Recognition. Moreover, PNP output type, which is much in demand in Europe, is also available.

- FIBER SENSORS
- LASER SENSORS
- PHOTOELECTRIC SENSORS
- MICRO PHOTOELECTRIC SENSORS
- AREA SENSORS
- LIGHT CURTAINS / SAFETY COMPONENTS
- PRESSURE / FLOW SENSORS
- INDUCTIVE PROXIMITY SENSORS
- PARTICULAR USE SENSORS**
- SENSOR OPTIONS
- SIMPLE WIRE-SAVING UNITS
- WIRE-SAVING SYSTEMS
- MEASUREMENT SENSORS
- STATIC ELECTRICITY PREVENTION DEVICES
- LASER MARKERS
- PLC
- HUMAN MACHINE INTERFACES
- ENERGY CONSUMPTION VISUALIZATION COMPONENTS
- FA COMPONENTS
- MACHINE VISION SYSTEMS
- UV CURING SYSTEMS

- Selection Guide
- Wafer Detection
- Liquid Leak Detection
- Liquid Level Detection
- Water Detection
- Color Mark Detection
- Hot Melt Glue Detection
- Ultrasonic
- Small / Slim Object Detection
- Obstacle Detection
- Other Products

APPLICATIONS

Detecting post-cards

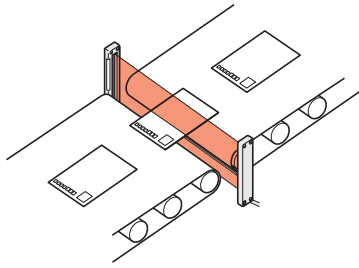

Detecting falling objects whose path is uncertain

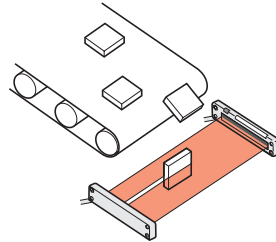

Detecting the edges of moving objects

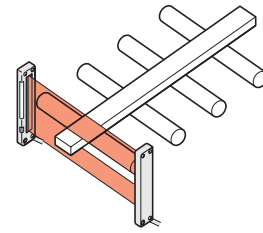

FIBER SENSORS

LASER SENSORS

PHOTOELECTRIC SENSORS

MICRO PHOTOELECTRIC SENSORS

AREA SENSORS

LIGHT CURTAINS / SAFETY COMPONENTS

PRESSURE / FLOW SENSORS

INDUCTIVE PROXIMITY SENSORS

PARTICULAR USE SENSORS

SENSOR OPTIONS

SIMPLE WIRE-SAVING UNITS

WIRE-SAVING SYSTEMS

MEASUREMENT SENSORS

STATIC ELECTRICITY PREVENTION DEVICES

LASER MARKERS

PLC

HUMAN MACHINE INTERFACES

ENERGY CONSUMPTION VISUALIZATION COMPONENTS

FA COMPONENTS

MACHINE VISION SYSTEMS

UV CURING SYSTEMS

Selection Guide

Wafer Detection

Liquid Leak Detection

Liquid Level Detection

Water Detection

Color Mark Detection

Hot Melt Glue Detection

Ultrasonic

Small / Slim Object Detection

Obstacle Detection

Other Products

NA1-11

 **WARNING** Never use this product in any personnel safety application.

No synchronization wire

Wiring is saved and made simple as no synchronization wire is required between the emitter and the receiver.

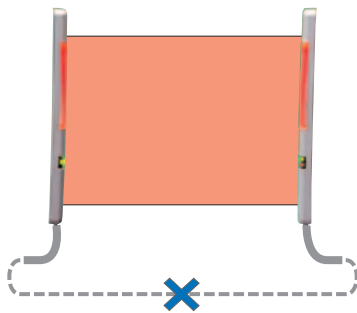

Clearly visible indicator

A clearly visible large indicator, having a 55 mm 2.165 in width, is incorporated on both the emitter and the receiver. Further, if the sensing output is directly connected to the large indicator input, the indicator can be conveniently used as a large operation indicator. Moreover, its operation is selectable between lighting or blinking.

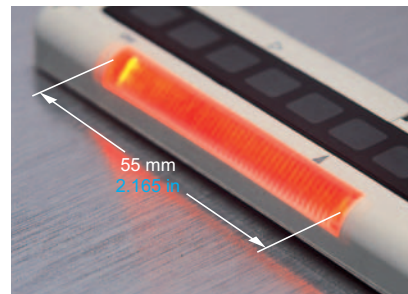

Cross-beam Scanning System

In a conventional area sensor, slim objects cannot be detected since the emitting and the receiving elements are scanned synchronously as a set. In contrast, in **NA1-11**, only the elements ① to ⑪ of the emitter are scanned to obtain emission. The elements of the receiver are not scanned, so that when element ① of the emitter emits light, all the elements of the receiver receive light. Hence, even if there is one element on the receiver which does not receive light, it results in light interrupted operation. With this technique, detection of slim objects is possible.

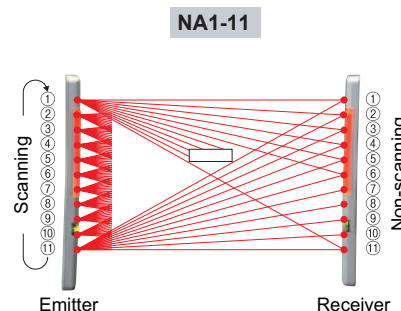
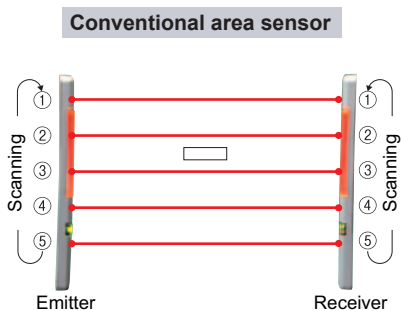

NA1-11

- FIBER SENSORS
- LASER SENSORS
- PHOTO-ELECTRIC SENSORS
- MICRO PHOTO-ELECTRIC SENSORS
- AREA SENSORS
- LIGHT CURTAINS / SAFETY COMPONENTS
- PRESSURE / FLOW SENSORS
- INDUCTIVE PROXIMITY SENSORS
- PARTICULAR USE SENSORS
- SENSOR OPTIONS
- SIMPLE WIRE-SAVING UNITS
- WIRE-SAVING SYSTEMS
- MEASURE-MENT SENSORS
- STATIC ELECTRICITY PREVENTION DEVICES
- LASER MARKERS
- PLC
- HUMAN MACHINE INTERFACES
- ENERGY CONSUMPTION VISUALIZATION COMPONENTS
- FA COMPONENTS
- MACHINE VISION SYSTEMS
- UV CURING SYSTEMS
- Selection Guide
- Wafer Detection
- Liquid Leak Detection
- Liquid Level Detection
- Water Detection
- Color Mark Detection
- Hot Melt Glue Detection
- Ultrasonic
- Small / Slim Object Detection
- Obstacle Detection
- Other Products

ORDER GUIDE

Type	Appearance	Sensing range (Note1)	Model No.(Note2)	Output
NPN output	<p>Sensing height: 100 mm 3.937 in</p> <p>Sensing range: 0.17 to 1 m 0.558 to 3.281 ft</p>	<p>0.17 to 1 m 0.558 to 3.281 ft</p>	NA1-11	NPN open-collector transistor
			NA1-11-C5	
PNP output	<p>No. of elements per emitter / receiver: 11</p> <p>Element pitch: 10 mm 0.394 in</p>	<p>0.17 to 1 m 0.558 to 3.281 ft</p>	NA1-11-PN	PNP open-collector transistor

Notes: 1) The sensing range is the possible setting distance between the emitter and the receiver.

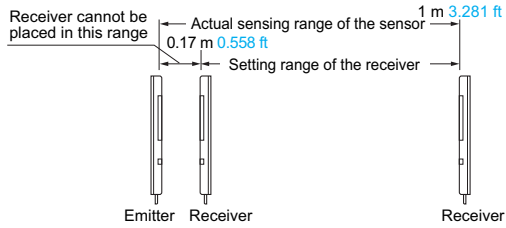

2) The model No. with suffix "P" shown on the label affixed to the product is the emitter, "D" shown on the label is the receiver.

OPTIONS

Designation	Model No.	Description
Sensor mounting bracket	MS-NA1-1	Four bracket set Four M4 (length 15 mm 0.591 in) screws with washers, eight nuts, four hooks, four spacers and eight M4 (length 18 mm 0.709 in) screws with washers are attached. (Spacers are not attached with MS-NA1-1 .)
	MS-NA2-1	

Sensor mounting bracket

• MS-NA1-1

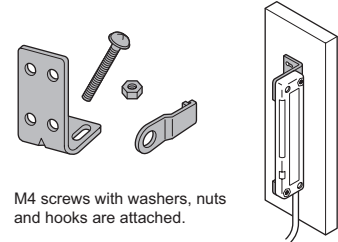

M4 screws with washers, nuts and hooks are attached.

• MS-NA2-1

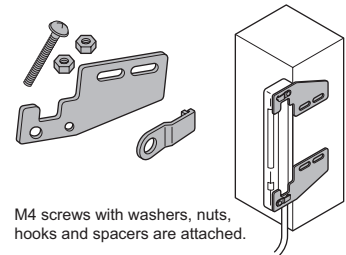

M4 screws with washers, nuts, hooks and spacers are attached.

SPECIFICATIONS

Item	Type	NPN output	PNP output
	Model No.	NA1-11	NA1-11-PN
Sensing height		100 mm 3.937 in	
Sensing range (Note 2)		0.17 to 1 m 0.558 to 3.281 ft	
Element pitch		10 mm 0.394 in	
Number of emitting / receiving elements		11 Nos. each on the emitter and the receiver, respectively	
Sensing object		ø13.5 mm ø0.531 in or more opaque object (Note 3)	
Supply voltage		12 to 24 V DC ±10 % Ripple P-P 10 % or less	
Current consumption		Emitter: 80 mA or less, Receiver: 100 mA or less	
Output		NPN open-collector transistor <ul style="list-style-type: none"> Maximum sink current: 100 mA Applied voltage: 30 V DC or less (between output and 0 V) Residual voltage: 1 V or less (at 100 mA sink current) 0.4 V or less (at 16 mA sink current) 	PNP open-collector transistor <ul style="list-style-type: none"> Maximum source current: 100 mA Applied voltage: 30 V DC or less (between output and +V) Residual voltage: 1 V or less (at 100 mA source current) 0.4 V or less (at 16 mA source current)
	Utilization category	DC-12 or DC-13	
	Output operation	ON or OFF when beam channel is interrupted, selectable by operation mode switch	
	Short-circuit protection	Incorporated	
Response time		In Dark state: 5 ms or less, In Light state: 10 ms or less	
Indicators	Emitter	Power indicator: Green LED (lights up when the power is ON) Large indicator: Orange LED (lights up or blinks when the large indicator input is Low, lighting pattern is selected by operation mode switch)	Power indicator: Green LED (lights up when the power is ON) Large indicator: Orange LED (lights up or blinks when the large indicator input is High, lighting pattern is selected by operation mode switch)
	Receiver	Operation indicator: Orange LED (lights up when the output is ON) Power indicator: Green LED (lights up when the power is ON) Large indicator: Orange LED (lights up or blinks when the large indicator input is Low, lighting pattern is selected by operation mode switch)	Operation indicator: Orange LED (lights up when the output is ON) Power indicator: Green LED (lights up when the power is ON) Large indicator: Orange LED (lights up or blinks when the large indicator input is High, lighting pattern is selected by operation mode switch)
Environmental resistance	Pollution degree	3 (Industrial environment)	
	Protection	IP62 (IEC)	
	Ambient temperature	-10 to 55 °C +14 to +131 °F (No dew condensation or icing allowed), Storage: -20 to +70 °C -4 to +158 °F	
	Ambient humidity	35 to 85 % RH, Storage: 35 to 85 % RH	
	Ambient illuminance	Incandescent light: 3,000 lx at the light-receiving face	
	EMC	EN 60947-5-2	
	Voltage withstandability	1,000 V AC for one min. between all supply terminals connected together and enclosure	
	Insulation resistance	20 MΩ, or more, with 250 V DC megger between all supply terminals connected together and enclosure	
	Vibration resistance	10 to 150 Hz frequency, 1.5 mm 0.059 in amplitude in X, Y and Z directions for two hours each	
	Shock resistance	500 m/s ² acceleration (50 G approx.) in X, Y and Z directions for three times each	
Emitting element		Infrared LED (Peak emission wavelength: 880nm 0.035mil , cross-beam scanning system)	
Material		Enclosure: Heat-resistant ABS, Lens: Acrylic, Indicator cover: Acrylic	
Cable		0.3 mm ² 4-core (emitter: 3-core) oil resistant cabtyre cable, 2 m 6.562 ft long	
Cable extension		Extension up to total 100 m 328.084 ft is possible, for both emitter and receiver, with 0.3 mm ² , or more, cable.	
Weight		Net weight: Emitter 80 g approx., Receiver 85 g approx, Gross Weight: 210 g approx.	

Notes: 1) Where measurement conditions have not been specified precisely, the conditions used were an ambient temperature of +23 °C **+73.4 °F**.

2) The sensing range is the possible setting distance between the emitter and the receiver.

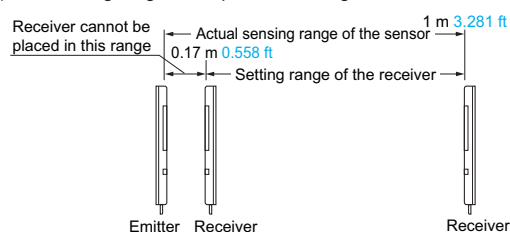

3) Although this product can detect slim objects by using the cross-beam scanning system, the size of the slim object which can be stably detected differs with the setting distance. When this sensor is used to detect slim objects, make sure to confirm stable detection using the actual objects.

FIBER SENSORS

LASER SENSORS

PHOTO-ELECTRIC SENSORS

MICRO PHOTO-ELECTRIC SENSORS

AREA SENSORS

LIGHT CURTAINS / SAFETY COMPONENTS

PRESSURE / FLOW SENSORS

INDUCTIVE PROXIMITY SENSORS

PARTICULAR USE SENSORS

SENSOR OPTIONS

SIMPLE WIRE-SAVING UNITS

WIRE-SAVING SYSTEMS

MEASUREMENT SENSORS

STATIC ELECTRICITY PREVENTION DEVICES

LASER MARKERS

PLC

HUMAN MACHINE INTERFACES

ENERGY CONSUMPTION VISUALIZATION COMPONENTS

FA COMPONENTS

MACHINE VISION SYSTEMS

UV CURING SYSTEMS

Selection Guide

Wafer Detection

Liquid Leak Detection

Liquid Level Detection

Water Detection

Color Mark Detection

Hot Melt Glue Detection

Ultrasonic

Small / Slim Object Detection

Obstacle Detection

Other Products

NA1-11

- FIBER SENSORS
- LASER SENSORS
- PHOTO-ELECTRIC SENSORS
- MICRO PHOTO-ELECTRIC SENSORS
- AREA SENSORS
- LIGHT CURTAINS / SAFETY COMPONENTS
- PRESSURE / FLOW SENSORS
- INDUCTIVE PROXIMITY SENSORS
- PARTICULAR USE SENSORS
- SENSOR OPTIONS
- SIMPLE WIRE-SAVING UNITS
- WIRE-SAVING SYSTEMS
- MEASUREMENT SENSORS
- STATIC ELECTRICITY PREVENTION DEVICES
- LASER MARKERS
- PLC
- HUMAN MACHINE INTERFACES
- ENERGY CONSUMPTION VISUALIZATION COMPONENTS
- FA COMPONENTS
- MACHINE VISION SYSTEMS
- UV CURING SYSTEMS
- Selection Guide
- Wafer Detection
- Liquid Leak Detection
- Liquid Level Detection
- Water Detection
- Color Mark Detection
- Hot Melt Glue Detection
- Ultrasonic
- Small / Slim Object Detection
- Obstacle Detection
- Other Products

I/O CIRCUIT AND WIRING DIAGRAMS

NA1-11

NPN output type

I/O circuit diagram

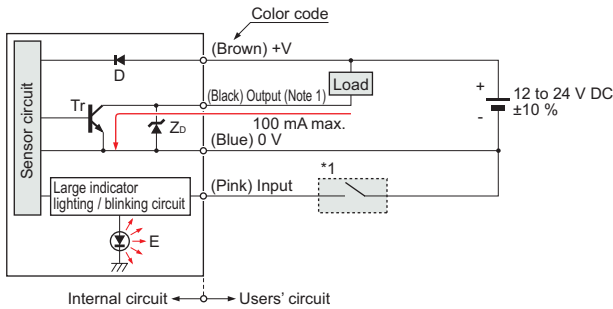

Wiring diagram

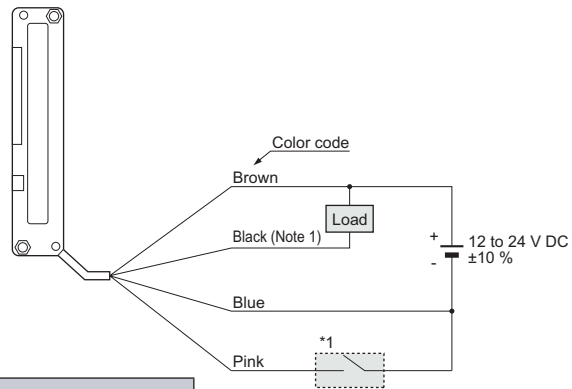

- Notes: 1) The emitter does not incorporate the output (black).
 2) Unused wires must be insulated to ensure that they do not come into contact with wires already in use.

Symbols ... D : Reverse supply polarity protection diode
 Zd: Surge absorption zener diode
 Tr : NPN output transistor
 E : Large indicator (INDICATOR)

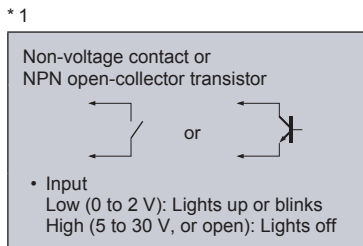

- Notes: 1) The emitter does not incorporate the black lead wire.
 2) Unused wires must be insulated to ensure that they do not come into contact with wires already in use.

NA1-11-PN

PNP output type

I/O circuit diagram

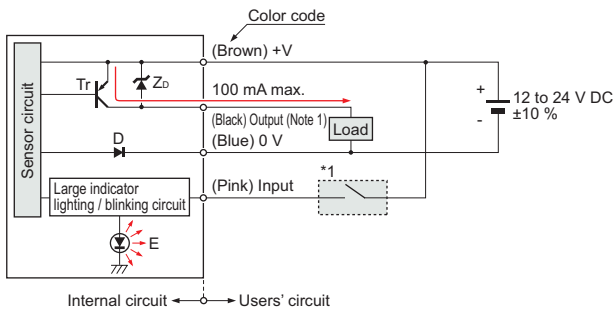

Wiring diagram

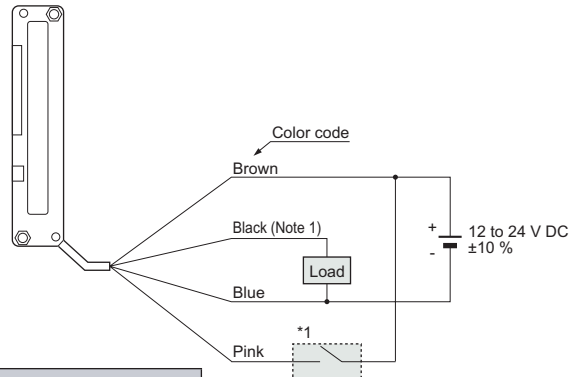

- Notes: 1) The emitter does not incorporate the output (black).
 2) Unused wires must be insulated to ensure that they do not come into contact with wires already in use.

Symbols ... D : Reverse supply polarity protection diode
 Zd: Surge absorption zener diode
 Tr : PNP output transistor
 E : Large indicator (INDICATOR)

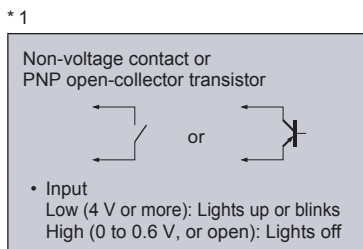

- Notes: 1) The emitter does not incorporate the black lead wire.
 2) Unused wires must be insulated to ensure that they do not come into contact with wires already in use.

SENSING CHARACTERISTICS (TYPICAL)

Correlation between setting distance and excess gain

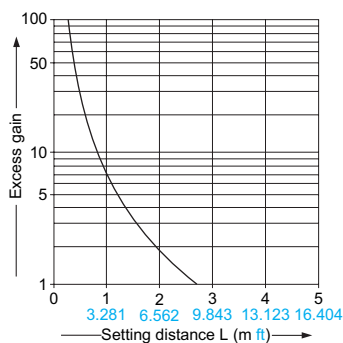

SENSING CHARACTERISTICS (TYPICAL)

Parallel deviation

Vertical direction

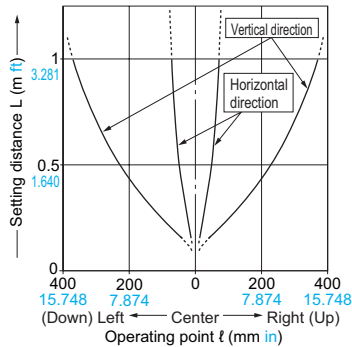
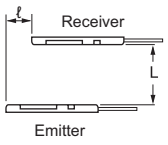

Horizontal direction

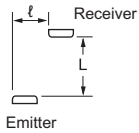

Angular deviation

Emitter angular deviation

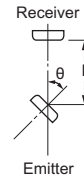

Receiver angular deviation

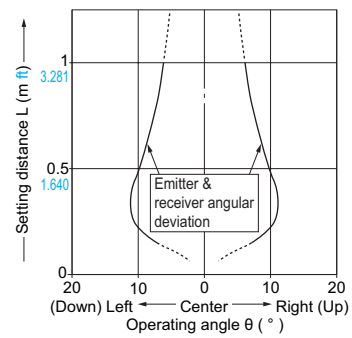
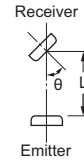

Correlation between setting distance and minimum length of detectable object

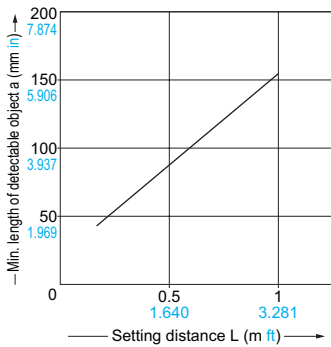

The minimum length of the detectable object, which lies in a plane perpendicular to the sensor front surface, varies with the setting distance, as shown in the left graph. However, note that the minimum length of the detectable object also varies with the object thickness.

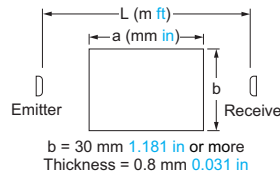

* The sensing object is considered to be placed at the center of the sensing area.

PRECAUTIONS FOR PROPER USE

Refer to p.1458~ for general precautions.



- Never use this product as a sensing device for personnel protection.
- For sensing devices to be used as safety devices for press machines or for personnel protection, use products which meet laws and standards, such as OSHA, ANSI or IEC etc., for personnel protection applicable in each region or country.
- If this product is used as a sensing device for personnel protection, death or serious body injury could result.
- For a product which meets safety standards, use the following products.
Type 4: **SF4C** series (p.531~)
Type 2: **SF2C** series (p.551~)

Mounting

- Use M4 screws with washers and M4 nuts. The tightening torque should be 0.5 N·m or less. (Purchase the screws and nuts separately.)

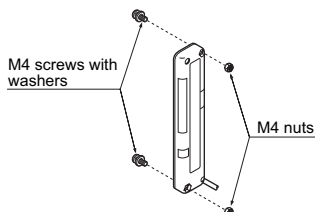

Selection of large indicator operation

- Lighting / Blinking is selected by the operation mode switch on the emitter and the receiver.

Operation of large indicator	Operation mode switch	
	Emitter	Receiver
Lighting	LIGHT <input type="checkbox"/> BLINK <input type="checkbox"/>	LIGHT <input type="checkbox"/> BLINK <input type="checkbox"/>
Blinking	LIGHT <input type="checkbox"/> BLINK <input type="checkbox"/>	LIGHT <input type="checkbox"/> BLINK <input type="checkbox"/>

Selection of output operation

- The output operation mode is selected by the operation mode switch on the receiver.

(The switches must be set with the power supply off. The operation mode does not change if the switch setting is changed with the power supplied.)

Operation mode switch (Receiver)	Output operation	Operation indicator (Orange)
D-ON <input type="checkbox"/> L/ON <input type="checkbox"/>	ON in Dark state	Lights up when the output is ON
L-ON <input type="checkbox"/> L/ON <input type="checkbox"/>	OFF in Dark state	Lights up when the output is ON

Note: LIGHT / BLINK switch is not related to the output operation selection.

FIBER SENSORS

LASER SENSORS

PHOTO-ELECTRIC SENSORS

MICRO PHOTO-ELECTRIC SENSORS

AREA SENSORS

LIGHT CURTAINS / SAFETY COMPONENTS

PRESSURE / FLOW SENSORS

INDUCTIVE PROXIMITY SENSORS

PARTICULAR USE SENSORS

SENSOR OPTIONS

SIMPLE WIRE-SAVING UNITS

WIRE-SAVING SYSTEMS

MEASUREMENT SENSORS

STATIC ELECTRICITY PREVENTION DEVICES

LASER MARKERS

PLC

HUMAN MACHINE INTERFACES

ENERGY CONSUMPTION VISUALIZATION COMPONENTS

FA COMPONENTS

MACHINE VISION SYSTEMS

UV CURING SYSTEMS

Selection Guide

Wafer Detection

Liquid Leak Detection

Liquid Level Detection

Water Detection

Color Mark Detection

Hot Melt Glue Detection

Ultrasonic

Small / Slim Object Detection

Obstacle Detection

Other Products

PRECAUTIONS FOR PROPER USE

Refer to p.1458~ for general precautions.

Others

- Do not use during the initial transient time (0.5 sec.) after the power supply is switched on.
- Although this sensor can detect slim objects by using the cross-beam scanning system, the size of the slim object which can be stably detected differs with the setting distance. Hence, when the sensor is used to detect slim objects, make sure to confirm stable detection using the actual objects.
- In case of this sensor, light from the emitter spreads above and below the sensor. Hence, take care that if there is a reflective object above or below the sensor it will affect the sensing.

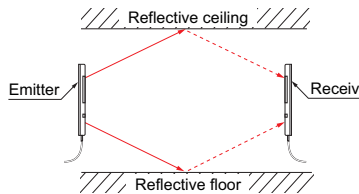

* Refer to p.958 for "Parallel deviation" in "SENSING CHARACTERISTICS (TYPICAL)".

DIMENSIONS (Unit: mm in)

The CAD data in the dimensions can be downloaded from our website.

NA1-11 NA1-11-PN

Sensor

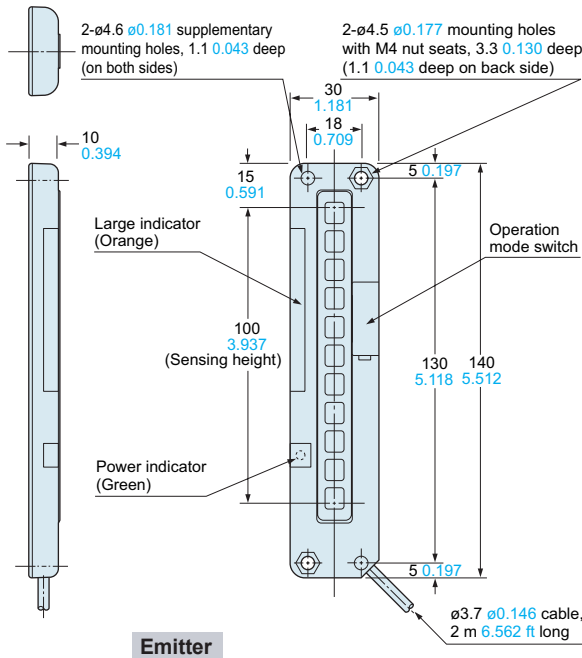

Emitter

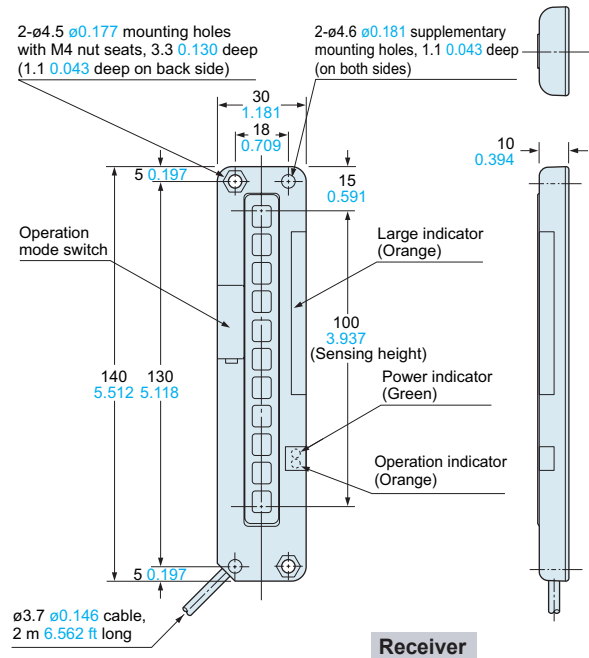

Receiver

FIBER SENSORS

LASER SENSORS

PHOTO-ELECTRIC SENSORS

MICRO PHOTO-ELECTRIC SENSORS

AREA SENSORS

LIGHT CURTAINS / SAFETY COMPONENTS

PRESSURE / FLOW SENSORS

INDUCTIVE PROXIMITY SENSORS

PARTICULAR USE SENSORS

SENSOR OPTIONS

SIMPLE WIRE-SAVING UNITS

WIRE-SAVING SYSTEMS

MEASUREMENT SENSORS

STATIC ELECTRICITY PREVENTION DEVICES

LASER MARKERS

PLC

HUMAN MACHINE INTERFACES

ENERGY CONSUMPTION VISUALIZATION COMPONENTS

FA COMPONENTS

MACHINE VISION SYSTEMS

UV CURING SYSTEMS

Selection Guide

Wafer Detection

Liquid Leak Detection

Liquid Level Detection

Water Detection

Color Mark Detection

Hot Melt Glue Detection

Ultrasonic

Small / Slim Object Detection

Obstacle Detection

Other Products

DIMENSIONS (Unit: mm in)

The CAD data in the dimensions can be downloaded from our website.

MS-NA1-1

Sensor mounting bracket (Optional)

Assembly dimensions

Mounting drawing with the receiver

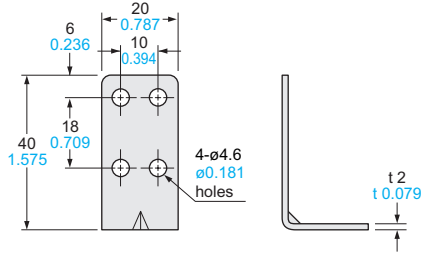

Material: Cold rolled carbon steel (SPCC)
(Uni-chrome plated)

Four bracket set

Four M4 (length 15 mm 0.591 in) screws with washers, eight nuts, four hooks and eight M4 (length 18 mm 0.709 in) screws with washers are attached.
(M4 (length 18 mm 0.709 in) screws with washers are not used for NA1-11.)

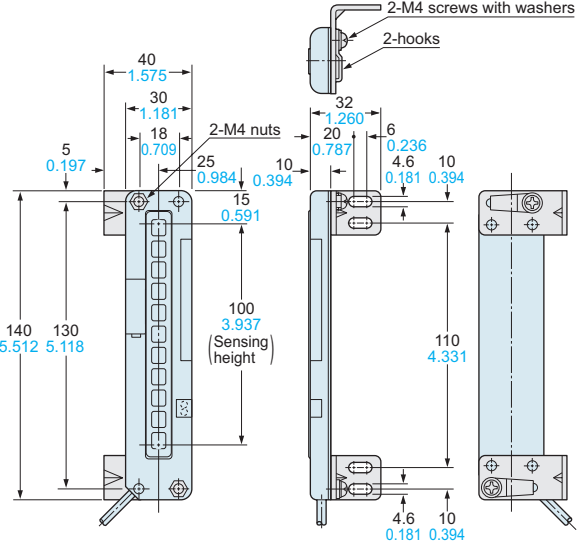
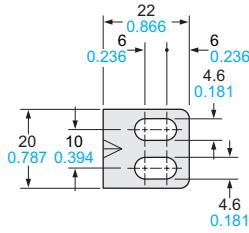

MS-NA2-1

Sensor mounting bracket (Optional)

Assembly dimensions

Mounting drawing with the receiver

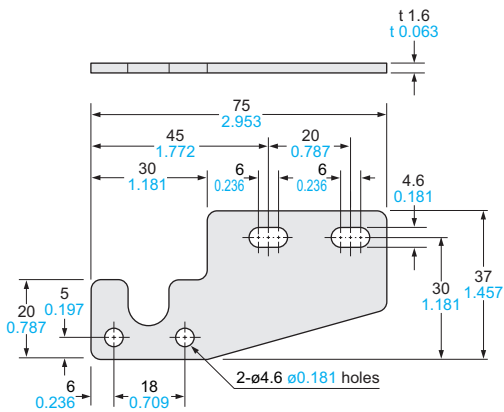

Material: Cold rolled carbon steel (SPCC)
(Uni-chrome plated)

Four bracket set

Four M4 (length 15 mm 0.591 in) screws with washers, eight nuts, four hooks, four spacers and eight M4 (length 18 mm 0.709 in) screws with washers are attached.

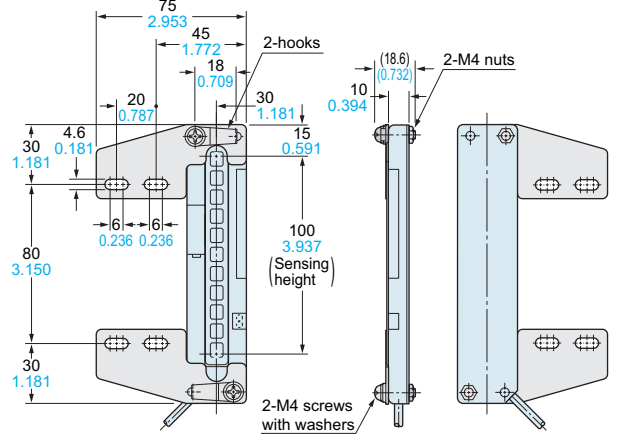

FIBER SENSORS

LASER SENSORS

PHOTO-ELECTRIC SENSORS

MICRO PHOTO-ELECTRIC SENSORS

AREA SENSORS

LIGHT CURTAINS / SAFETY COMPONENTS

PRESSURE / FLOW SENSORS

INDUCTIVE PROXIMITY SENSORS

PARTICULAR USE SENSORS

SENSOR OPTIONS

SMILE WIRE-SAVING UNITS

WIRE-SAVING SYSTEMS

MEASUREMENT SENSORS

STATIC ELECTRICITY PREVENTION DEVICES

LASER MARKERS

PLC

HUMAN MACHINE INTERFACES

ENERGY CONSUMPTION VISUALIZATION COMPONENTS

FA COMPONENTS

MACHINE VISION SYSTEMS

UV CURING SYSTEMS

Selection Guide

Wafer Detection

Liquid Leak Detection

Liquid Level Detection

Water Detection

Color Mark Detection

Hot Melt Glue Detection

Ultrasonic

Small / Slim Object Detection

Obstacle Detection

Other Products