

Features

Regulated Converters

- 4:1 Wide Input Voltage Range
- 1.5kVDC / 1 min. Isolation
- UL/IEC/EN60950 Certified & EN50155 Pending
- Efficiency up to 93.3%
- OVP, OCP & OTP
- +105°C max Case Temperature



RPA60-FW

60 Watt
2"x1"
Single Output



UL60950-1 Certified
IEC/EN60950 Certified
EN50155 Pending

Description

The RPA60-FW series are high power density, wide input voltage range 60W DC/DC converters in an industry standard 2"x1" case size. Despite their small size, the RPA60-FW converters are fully specified devices with output currents up to 12Amps, up to 93% efficiency, no minimum load, UVLO, 1500VDC / 1 minute isolation, tight regulation and low ripple/noise figures. The trimmable outputs are also fully protected against over-temperature, short circuits, overcurrent and overvoltage. The converters are UL/IEC/EN60950 certified and EN50155 pending and will find many uses in railway and industrial applications where board space is at a premium.

Selection Guide

Part Number	Input Voltage Range [VDC]	Output Voltage [VDC]	Output Current [mA]	Input ⁽¹⁾ Current [mA]	Efficiency ⁽¹⁾ typ. [%]	Max. Capacitive Load [μF]
RPA60-2405SFW ^(2,3)	9-36	05	12000	2706	92.4	20000
RPA60-2412SFW ^(2,3)	9-36	12	5000	2694	92.8	6000
RPA60-2415SFW ^(2,3)	9-36	15	4000	2662	93.3	4000
RPA60-2424SFW ^(2,3)	9-36	24	2500	2688	93	2000

Notes:

Note1: Tested at nominal Vin, full load and at +25°C ambient

Model Numbering

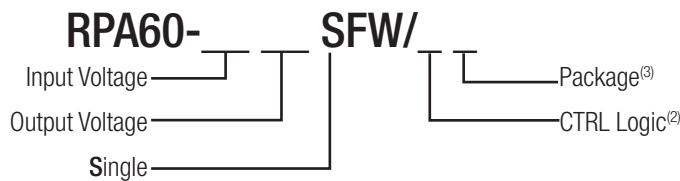

Ordering Examples

- RPA60-2405SFW = 24V Input, 5V Output, Single, no CTRL pin
- RPA60-2405SFW/P = 24V Input, 5V Output, Single, Pos. CTRL function
- RPA60-2415SFW/N-HC = 24V Input, 15V Output, Single, Neg. CTRL function, Heat-sink assembled

Notes:

- Note2: part without suffixes is without CTRL pin, trim pin fitted
 add suffix "P" for positive CTRL function (1=ON, 0=OFF), trim pin fitted
 add suffix "N" for negative CTRL function (0=ON, 1=OFF), trim pin fitted
- Note3: add suffix "-HC" for glued Heat-sink (compatible with all other suffixes)

Specifications measured @ $t_a = 25^\circ\text{C}$, resistive load, nominal V_{in} and rated I_{out} unless otherwise noted

BASIC CHARACTERISTICS				
Parameter	Condition	Min.	Typ.	Max.
Internal Input Filter				LC Filter
Input Voltage Range		9VDC	24VDC	36VDC
Input Surge Voltage	100ms max.			50VDC
Quiescent Current	5Vout 12Vout & 15Vout 24Vout		70mA 60mA 40mA	
Start-up time	Power up Remote ON/OFF		60ms	
Internal Operating Frequency			330kHz	
Minimum Load		0%		
Ripple and Noise	20MHz bw, 10 μ F tantalum capacitor and 1 μ F ceramic capacitor		100mVp-p	
Under Voltage Lockout (UVLO)	DC-DC ON	8VDC	8.5VDC	9VDC
	DC-DC OFF	7VDC	7.5VDC	8VDC
ON/OFF Control ⁽²⁾	Positive Logic DC-DC ON DC-DC OFF		Open or $2.4 < V_r < 10\text{VDC}$ Short or $0 < V_r < 0.8\text{VDC}$	
	Negative Logic DC-DC ON DC-DC OFF		Short or $0 < V_r < 0.8\text{VDC}$ Open or $2.4 < V_r < 10\text{VDC}$	
Input current of CTRL pin	DC-DC OFF		10mA	
Output Voltage Trimming		-10%		+10%

RPA60-2405SFW

Efficiency vs. Output Current

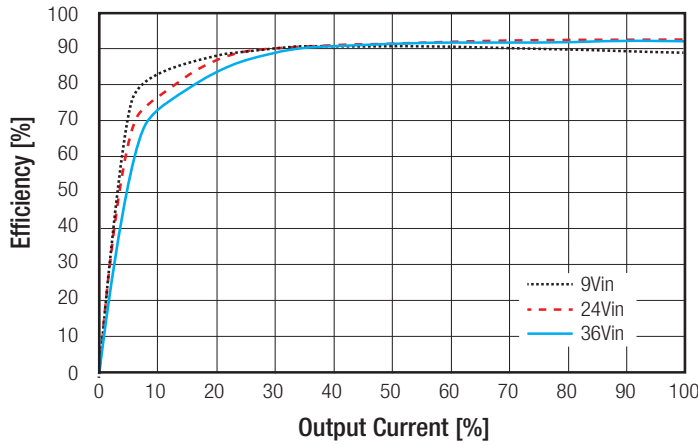

Power Dissipation vs Output Current

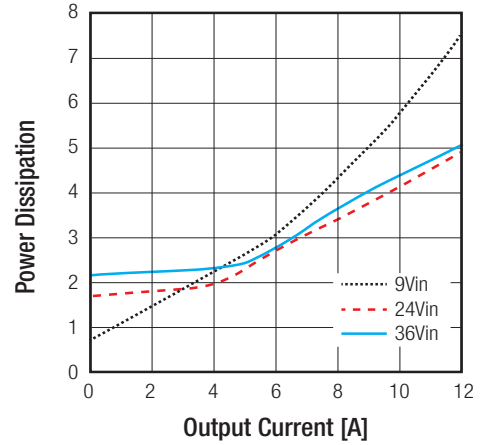

RPA60-2412SFW

Efficiency vs. Output Current

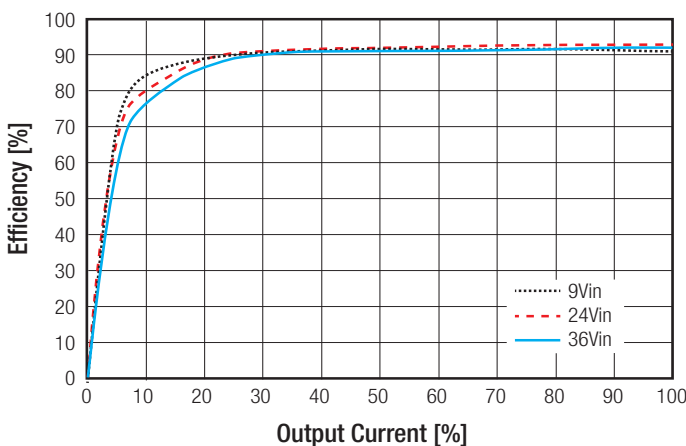

Power Dissipation vs Output Current

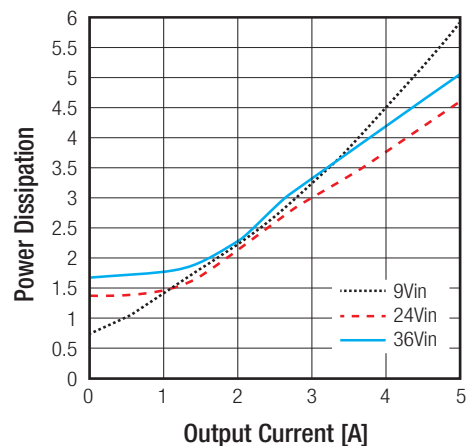

continued on next page

Specifications measured @ $t_a = 25^\circ\text{C}$, resistive load, nominal V_{in} and rated I_{out} unless otherwise noted

RPA60-2415SFV

Efficiency vs. Output Current

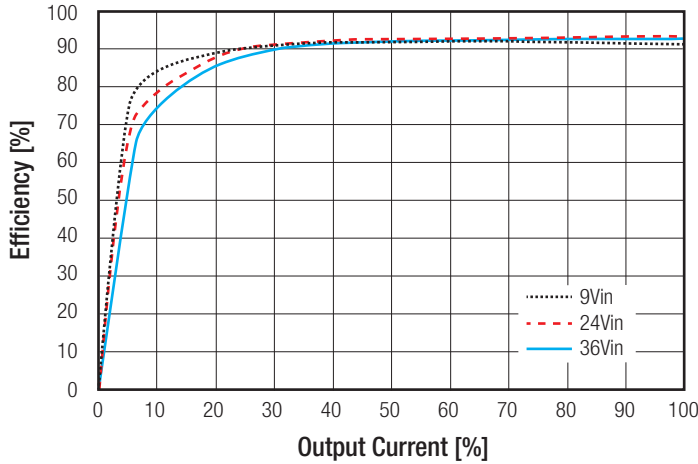

Power Dissipation vs. Output Current

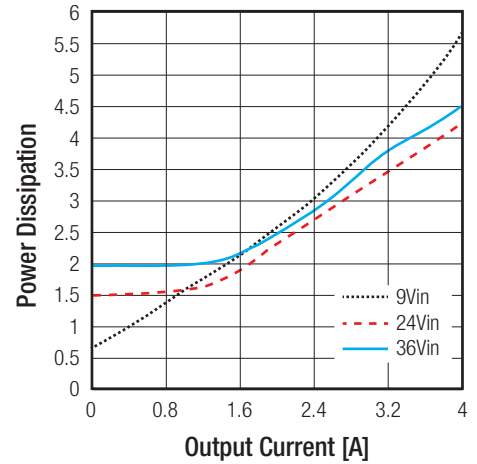

RPA60-2424SFV

Efficiency vs. Output Current

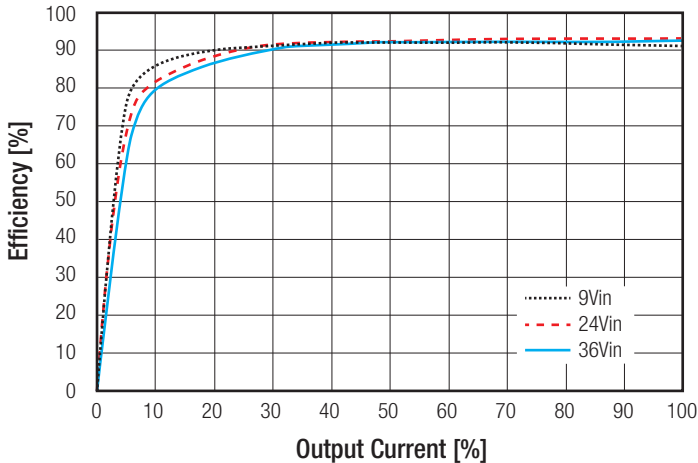

Power Dissipation vs. Output Current

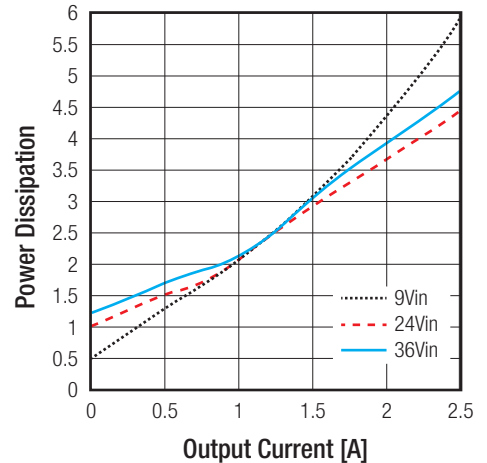

OUTPUT TRIM

Output Voltage Trimming

RPA60-FW converters offer the feature of trimming the output voltage over a certain range around the nominal value by using external trim resistors. The values for trim resistors shown in trim tables below are according to standard E96 values; therefore, the specified voltage may slightly vary.

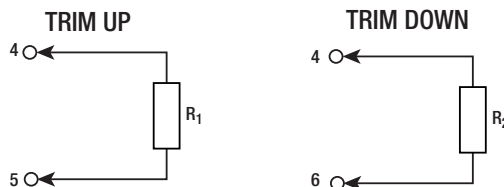

RPA60-2405SFV

Trim up	1	2	3	4	5	6	7	8	9	10	%
$V_{out} =$	5.05	5.10	5.15	5.20	5.25	5.30	5.35	5.40	5.45	5.50	Volts
$R_1 =$	604	243	147	95.3	68.1	39.2	34.8	22.1	15	8.06	kOhms
Trim down	1	2	3	4	5	6	7	8	9	10	%
$V_{out} =$	4.95	4.90	4.85	4.80	4.75	4.70	4.65	4.60	4.55	4.50	Volts
$R_2 =$	604	301	169	115	80.6	56.2	40.2	28	15	8.06	kOhms

continued on next page

Specifications measured @ $t_a = 25^\circ\text{C}$, resistive load, nominal V_{in} and rated I_{out} unless otherwise noted

RPA60-2412SFW											
Trim up	1	2	3	4	5	6	7	8	9	10	%
$V_{out} =$	12.12	12.24	12.36	12.48	12.60	12.72	12.84	12.96	13.08	13.20	Volts
$R_1 =$	604	255	154	105	75	49.9	38.3	24.9	18.2	10	kOhms
Trim down	1	2	3	4	5	6	7	8	9	10	%
$V_{out} =$	11.88	11.76	11.64	11.52	11.40	11.28	11.16	11.04	10.92	10.8	Volts
$R_2 =$	698	301	187	121	84.5	60.4	45.3	30.1	20	10	kOhms
RPA60-2415SFW											
Trim up	1	2	3	4	5	6	7	8	9	10	%
$V_{out} =$	15.15	15.3	15.45	15.60	15.75	15.90	16.05	16.20	16.35	16.50	Volts
$R_1 =$	750	309	191	124	71.5	59	40.2	28	15	8.06	kOhms
Trim down	1	2	3	4	5	6	7	8	9	10	%
$V_{out} =$	14.85	14.70	14.55	14.40	14.25	14.10	13.95	13.80	13.65	13.50	Volts
$R_2 =$	698	374	226	150	105	71.5	59	32.4	20	8.06	kOhms
RPA60-2424SFW											
Trim up	1	2	3	4	5	6	7	8	9	10	%
$V_{out} =$	24.24	24.48	24.72	24.96	25.2	25.44	25.68	25.92	26.16	26.4	Volts
$R_1 =$	1000	511	324	221	162	121	90.9	68.1	48.7	34.8	kOhms
Trim down	1	2	3	4	5	6	7	8	9	10	%
$V_{out} =$	23.76	23.52	23.38	23.04	22.8	22.56	22.32	22.08	21.84	21.6	Volts
$R_2 =$	1500	909	499	324	232	169	124	93.1	64.9	45.3	kOhms

REGULATION		
Parameter	Condition	Value
Output Accuracy		$\pm 1.0\%$ max.
Line Regulation	low line to high line	$\pm 0.2\%$ max.
Load Regulation		$\pm 0.5\%$
Transient Response	5 V_{out} others	$\pm 5.0\%$ V_{out} typ. $\pm 2.5\%$ V_{out} typ.
	25% load step change	250 μs typ.

PROTECTION		
Parameter	Condition	Value
Short Circuit Protection (SCP)	below 100m Ω	continuous, auto recovery
Over Voltage Protection (OVP)		115%-140% Output Voltage
Over Current Protection (OCP)		110%-150% Output Current, Hiccup
Over Temperature Protection (OTP)		115 $^\circ\text{C} \pm 5^\circ\text{C}$
Isolation Voltage ⁽⁵⁾	I/P to O/P	tested for 1 minute 1.5kVDC
Isolation Resistance		10M Ω min.
Isolation Capacitance		2200pF typ.
Insulation Grade		basic

Notes:

Note4: An input fuse is required if the mains supply is not over-current protected. Recommended fuse: 10A slow blow type.

Note5: For repeat Hi-Pot testing, reduce the time and/or the test voltage.

Specifications measured @ $t_a = 25^\circ\text{C}$, resistive load, nominal V_{in} and rated I_{out} unless otherwise noted

ENVIRONMENTAL

Parameter	Condition	Value
Operating Temperature Range ⁽⁶⁾		-40°C to [refer to thermal calculation]
Maximum Case Temperature		+105°C
Temperature Coefficient		0.02%/°C
Thermal Impedance		please refer to table 1
Operating Altitude		4500m
Operating Humidity		95% RH
MTBF	according to MIL-HDBK-217F standard, 25°C	5997 x 10 ³ hours

Table 1: Thermal Impedance

airflow [m/s]	without Heatsink		with Heatsink	
	R _{th} without PCB [°C/W]	R _{th} with PCB ⁽⁶⁾ [°C/W]	R _{th} without PCB [°C/W]	R _{th} with PCB ⁽⁶⁾ [°C/W]
0.1	11.5	7.5	9.6	6.8
0.2	8.9	5.6	7.4	5.1
0.5	6.6	4.1	5.5	3.8
1.0	4.8	3.0	4.0	2.7
1.5	3.9	2.5	3.3	2.2
2.0	3.0	1.9	2.5	1.7

Notes:

Note6: Test PCB:160x100mm105µm (Eurocard), double layer

Thermal Calculation

choose your model:

RPA60-2405SFW (with PCB ⁽⁶⁾)

- Load conditions in application (e.g. 50%)
- Airflow conditions in application (e.g. 0.5m/s)
- use R_{th} from Table1 (4.1°C/W)

Calculation:

$$\begin{aligned}
 I_{out} &= 50\% \\
 R_{th} &= 4.1^\circ\text{C/W} \\
 P_{DISS} &= 2.75\text{W} \\
 T_{CASEmax} &= 105^\circ\text{C}
 \end{aligned}$$

$$T_{OVER} = R_{th} \times P_{Dis} = 4.1^\circ\text{C/W} \times 2.75\text{W} = \mathbf{11.3^\circ\text{C}}$$

$$T_{AMBmax} = T_{CASEmax} - T_{OVER} = 105^\circ\text{C} - 11.3^\circ\text{C} = \mathbf{93.7^\circ\text{C}}$$

choose your model:

RPA60-2405SFW-HC (with PCB ⁽⁶⁾)

- Load conditions in application (e.g. 50%)
- Airflow conditions in application (e.g. 0.5m/s)
- use R_{th} from Table1 (3.8°C/W)

Calculation:

$$\begin{aligned}
 I_{out} &= 50\% \\
 R_{th} &= 3.8^\circ\text{C/W} \\
 P_{DISS} &= 2.75\text{W} \\
 T_{CASEmax} &= 105^\circ\text{C}
 \end{aligned}$$

$$T_{OVER} = R_{th} \times P_{Dis} = 3.8^\circ\text{C/W} \times 3.04\text{W} = \mathbf{10.5^\circ\text{C}}$$

$$T_{AMBmax} = T_{CASEmax} - T_{OVER} = 105^\circ\text{C} - 10.5^\circ\text{C} = \mathbf{94.5^\circ\text{C}}$$

RPA60-2405SFW

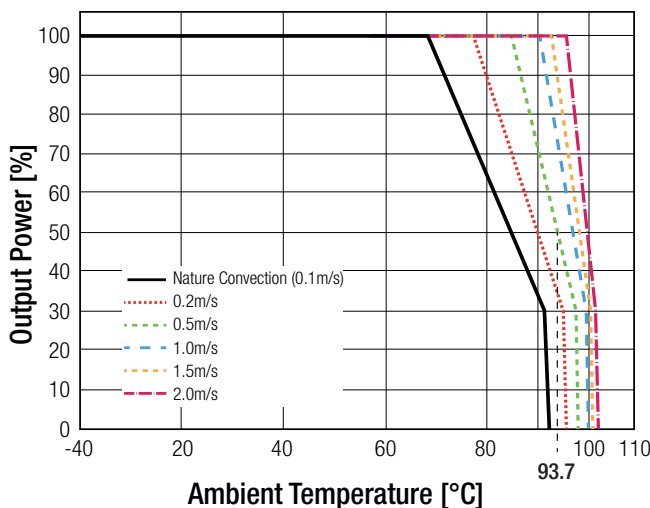

RPA60-2405SFW-HC

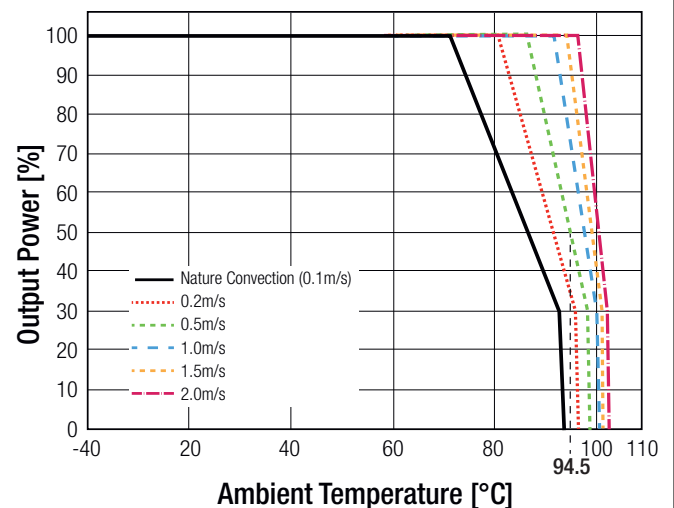

Specifications measured @ $t_a = 25^\circ\text{C}$, resistive load, nominal V_{in} and rated I_{out} unless otherwise noted

SAFETY AND CERTIFICATIONS

Certificate Type (Safety)	Report / File Number	Standard
Information Technology Equipment, General Requirements for Safety	E224736-A41	UL60950-1, 2nd Edition, 2014 CSA C22.2 No. 60950, 2nd Edition, 2014
IEC/EN Information Technology Equipment - General Requirments for Safety (CB Scheme)	E224736-A41-CB	IEC60950-1, 2nd Edition, 2005 + AM2, 2013 EN60950-1, 1st Edition, 2006 + AM2, 2013
Railway Applications - Electrical Equipment used on rolling stock	pending	EN50155, 1st Edition, 2007

EMC Compliance (designed to meet)

EMC Compliance (designed to meet)	Condition	Standard / Criterion
Information technology equipment - Radio disturbance characteristics Limits and methods of measurement	with external filter	EN55022, Class A, 2010

EMI Filtering according to EN50121-3-2 (EN50155) and EN55022 Class A

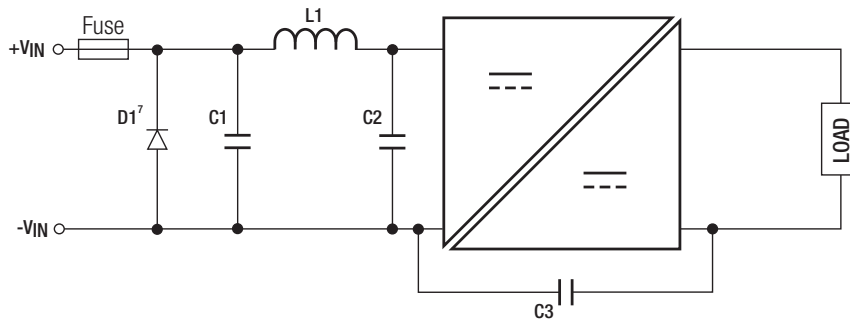

C1	C2	L1	C3
100 μF /50V electrolytic	6.8 μF /50V MLCC	4.7 μH SMD Inductor	6.8nF/2kV MLCC

Notes:

Note7: Diode is only needed for EN50155.

Conducted Emissions according to EN50121-3-2 (EN50155)

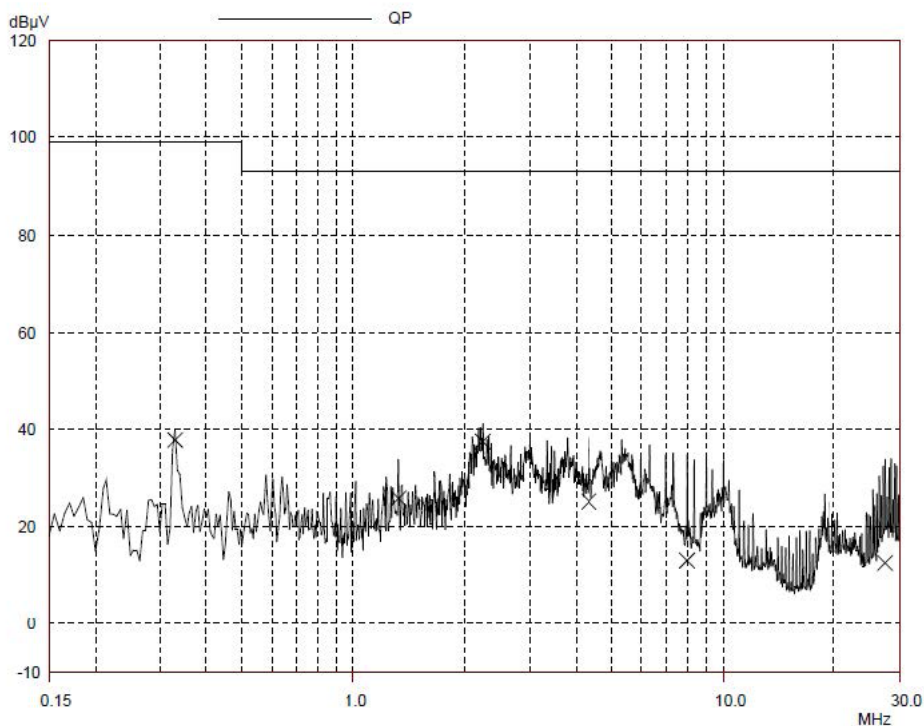

Specifications measured @ $t_a = 25^\circ\text{C}$, resistive load, nominal V_{in} and rated I_{out} unless otherwise noted

DIMENSIONS and PHYSICAL CHARACTERISTICS

Parameter	Type	Value
Material	Case Baseplate Potting	Al Alloy, anodize black non-conductive FR4 Silicone (UL94-0)
Package Dimensions (LxWxH)	without Heat-sink with Heat-sink	50.8 x 25.4 x 10.2mm 50.8 x 25.4 x 16.8mm
Package Weight	without Heat-sink with Heat-sink	35g typ. 46g typ.

Dimension Drawing (mm)

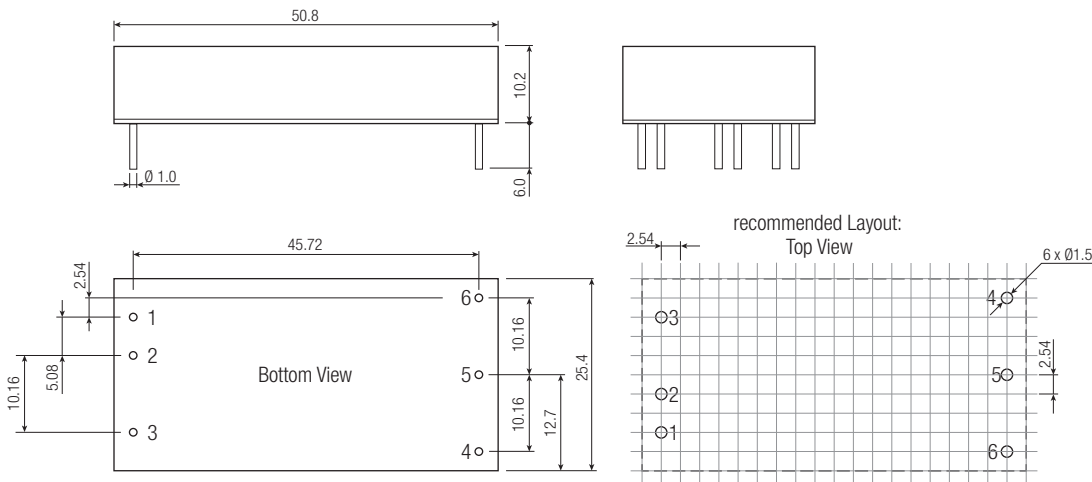
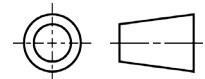

Heat-sink Dimension Drawing (mm)

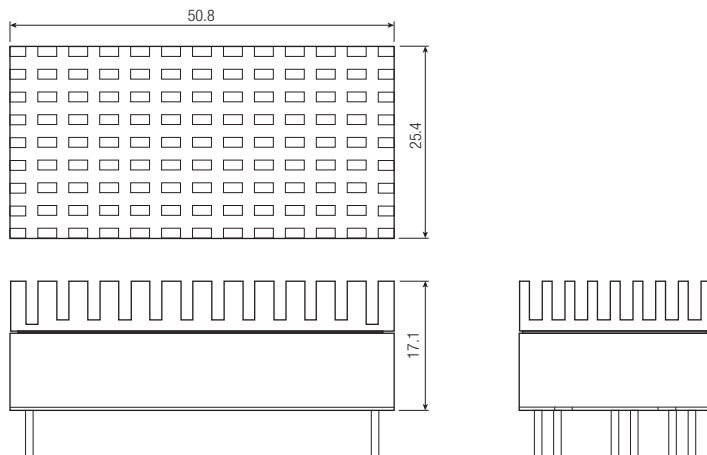

Pin Connections

Pin #	Single
1	+Vin
2	-Vin
3	CTRL ⁽²⁾
4	Trim
5	-Vout
6	+Vout

Pin Pitch Tolerance $\pm 0.25\text{mm}$
 Pin dimension tolerance $\pm 0.1\text{mm}$
 XX.X $\pm 0.5\text{mm}$
 XX.XX $\pm 0.25\text{mm}$

PACKAGING INFORMATION

Parameter	Type	Value
Packaging Dimensions (LxWxH)	without Heat-sink with Heat-sink	285.0 x 27.6 x 19.0mm 285.0 x 27.6 x 25.8mm
Packaging Quantity		5pcs
Storage Temperature Range		-55°C to $+125^\circ\text{C}$
Storage Humidity		5% - 95% RH

The product information and specifications are subject to change without prior notice. RECOM products are not authorized for use in safety-critical applications (such as life support) without RECOM's explicit written consent. A safety-critical application is defined as an application where a failure of a RECOM product may reasonably be expected to endanger or cause loss of life, inflict bodily harm or damage property. The buyer shall indemnify and hold harmless RECOM, its affiliated companies and its representatives against any damage claims in connection with the unauthorized use of RECOM products in such safety-critical applications.