

10 9 8 7 6 5 4 3 2 1

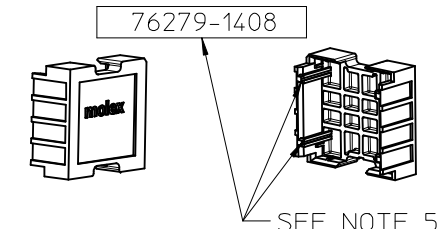
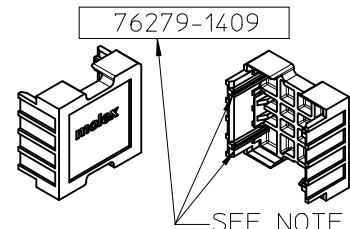
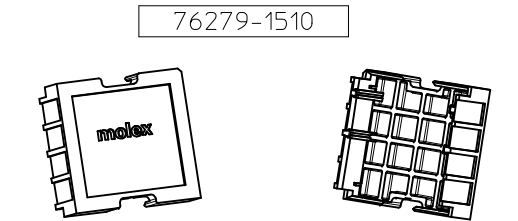
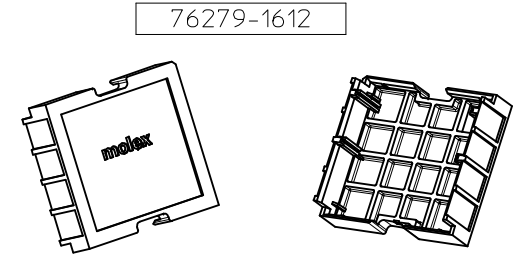
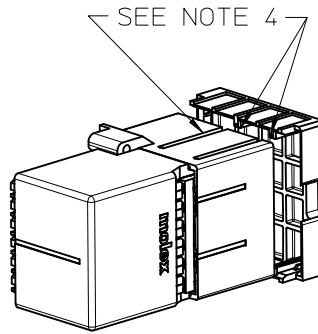
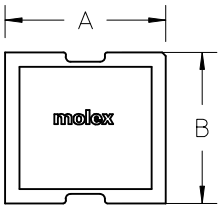
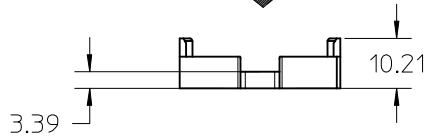
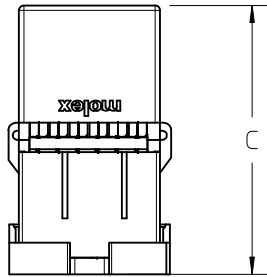
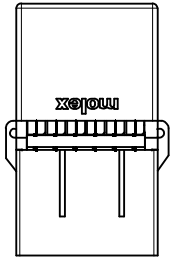

NOTES:

- MATERIAL: ABS
COLOR: NATURAL (WHITE)
- COVERS FIT BOTH GUIDED AND UNGUIDED CONFIGURATIONS.
- THIS PART CONFORMS TO CLASS B REQUIREMENTS OF COSMETIC SPEC PS-45499-002
- INTERNAL COVER RIBS ALIGN WITH SLOTS ON CONNECTOR HOUSING
- ONLY MATES WITH TWO SLOT 4 PAIR OD-RAM
- PLEASE SEE RAS-76279-9999 FOR DUST COVER USAGE AND REAPPLICATION GUIDELINES.

PART NUMBER	NUMBER OF PAIRS	NUMBER OF COLUMNS	DIM "A"	DIM "B"	DIM "C"
76279-1612	6 PAIR	12 COLUMN	32.9	30.9	55
76279-1510	5 PAIR	10 COLUMN	27.9	26.9	50
76279-1408	4 PAIR	8 COLUMN	23.8	22.8	46
76279-1409	4 PAIR/TOP GUIDE	8 COLUMN			

ADD 76279-1409 EC NO: UCP2015-3274 DRN:BJ MILLER 2015/01/12 CHKD: APPR:TELO 2015/02/12 REV A	DESCRIPTION 2015/02/12	QUALITY SYMBOLS	GENERAL TOLERANCES (UNLESS SPECIFIED)	DIMENSION STYLE	SCALE	DESIGN UNITS	THIRD ANGLE PROJECTION	
		$\nabla F/0$ $\nabla E/0$ $\nabla D/0$	mm INCH 4 PLACES ± --- ± --- 3 PLACES ± --- ± --- 2 PLACES ± 0.13 ± --- 1 PLACE ± 0.25 ± --- 0 PLACE ± --- ± ---	MM ONLY	1:1	METRIC	TITLE IMPACT ORTHOGONAL DIRECT PROTECTIVE DUST COVERS	
			ANGULAR ± 1/2° DRAFT WHERE APPLICABLE MUST REMAIN WITHIN DIMENSIONS	DRAWN BY DATE BJ MILLER 2013/08/09 CHECKED BY DATE	APPROVED BY DATE TELO 2015/02/12	MATERIAL NO. SEE CHART	DOCUMENT NO. SD-76279-1612	SHEET NO. 1 OF 1
				SIZE B THIS DRAWING CONTAINS INFORMATION THAT IS PROPRIETARY TO MOLEX INCORPORATED AND SHOULD NOT BE USED WITHOUT WRITTEN PERMISSION				

9 8 7 6 5 4 3 2 1