

60V, Low I_Q Multiphase Synchronous Step-Down Converter

DESCRIPTION

Demonstration circuit 2236A-B is a high output voltage, high efficiency synchronous PolyPhase[®] buck converter featuring the **LTC[®]3890EUH**. The DC2236A-B has wide input voltage range of 16V up to 60V, and is capable of delivering up to 25A of output current. The output voltage is set to 12V, however, the output voltage can go as high as 24V, with certain modifications. The DC2236A-B supports three operation modes: Fixed frequency modulation, pulse-skipping and Burst Mode[®] operation. Fixed frequency mode of operation maximizes the output current, reduces output voltage ripple, and yields a low noise switching spectrum. Burst Mode employs a variable frequency switching algorithm that minimizes the no-load input quiescent current and improves efficiency at light loads.

The DC2236A-B consumes less than 50 μ A of quiescent current during shutdown and less than 1mA under a no

load condition with the output in regulation in Burst Mode operation. The DC2236A-B has a standard operating frequency of 150kHz, but can be adjusted to frequencies as high as 900kHz. The DC2236A is a dual phase single output step-down converter; however it designed to be easily transformed to 4- or 6-phase system by combining two or three DC2236A-B boards. The LTC3890EUH data sheet gives a complete description of these parts, operation and application information and must be read in conjunction with this quick start guide for demonstration circuit 2236A-B. Table 1 summarizes the differences between the parts in the LTC3890 family.

Design files for this circuit board are available at <http://www.linear.com/demo/DC2236A-B>

LT, LTC, LTM, Linear Technology, Burst Mode, PolyPhase and the Linear logo are registered trademarks of Linear Technology Corporation. All other trademarks are the property of their respective owners.

PERFORMANCE SUMMARY

Specifications are at $T_A = 25^\circ\text{C}$

| PARAMETER | CONDITIONS | VALUE |
|--------------------------------------|---|----------------------|
| Minimum Input Voltage | | 16V |
| Maximum Input Voltage | | 60V |
| Output Voltage V_{OUT} Regulation | $V_{IN} = 16\text{V to }55\text{V}$ | $12\text{V} \pm 2\%$ |
| Maximum Continuous Output Current | | 25A |
| Preset Operating Frequency | $R7 = 30.1\text{k}\Omega$ | 150kHz |
| External Clock Sync. Frequency Range | | 75kHz to 850kHz |
| Efficiency | $V_{IN} = 36\text{V}$, $V_{OUT} = 12\text{V}$, $I_{OUT} = 12\text{A}$, See Figure 3 Efficiency Curves for Complete Operating Range | 97% |
| Typical Output Ripple V_{OUT} | $V_{IN} = 36\text{V}$, $I_{OUT} = 12\text{A}$ (20MHz BW) | <35mV _{p-p} |
| Quiescent Current at Shutdown | $V_{IN} = 16\text{V to }55\text{V}$ | <50 μ A |
| Input Current at No Load | $V_{IN} = 16\text{V to }55\text{V}$ | <1mA |

QUICK START PROCEDURE

Demonstration circuit 2236A-B is easy to set up to evaluate the performance of the LTC3890. For proper measurement equipment configuration, set up the circuit according to the diagram in Figure 1. Before proceeding to test, insert shunt into JP1 (RUN) OFF position, which connects the RUN pin to ground (GND), and thus, shuts down the circuit.

NOTE: When measuring the input or output voltage ripple, care must be taken to avoid a long ground lead on the oscilloscope probe. Measure the input or output voltage ripple by touching the probe tip directly across the V_{IN} or V_{OUT} and GND terminals. See Figure 2 for proper scope probe technique.

1. With the DC2236A-B set up according to the proper measurement and equipment in Figure 1, apply 20V at V_{IN} . Measure V_{OUT} ; it should read 0V. If desired, one can measure the shutdown supply current at this point. The supply current will be approximately 50 μ A, or less, in shutdown.
2. Turn on the circuit by inserting the shunt in header JP1 (RUN) into the ON position. The output voltage should be regulating. Measure V_{OUT} – it should measure 12V \pm 2% (**Do not apply more than the rated maximum voltage of 60V to the board or the part may be damaged**).
3. Vary the converter load, which should not exceed 25A. Note: all four input and output terminals V_{IN} , V_{OUT} and two GND equipped with two banana connectors, two-wires can be used for each terminal to reduce copper losses and heat dissipation in the interconnection lines.
4. Vary the input voltage from 16V to 55V, the V_{OUT} – it should measure 12V \pm 2%
5. Set output current to zero and move jumper JP2 (MODE) into BURST MODE position and measure V_{OUT} – it should register 12V \pm 2%.
6. Set output current to zero and move jumper JP2 (MODE) into PLS SKIP position and measure V_{OUT} – it should register 12V \pm 2%

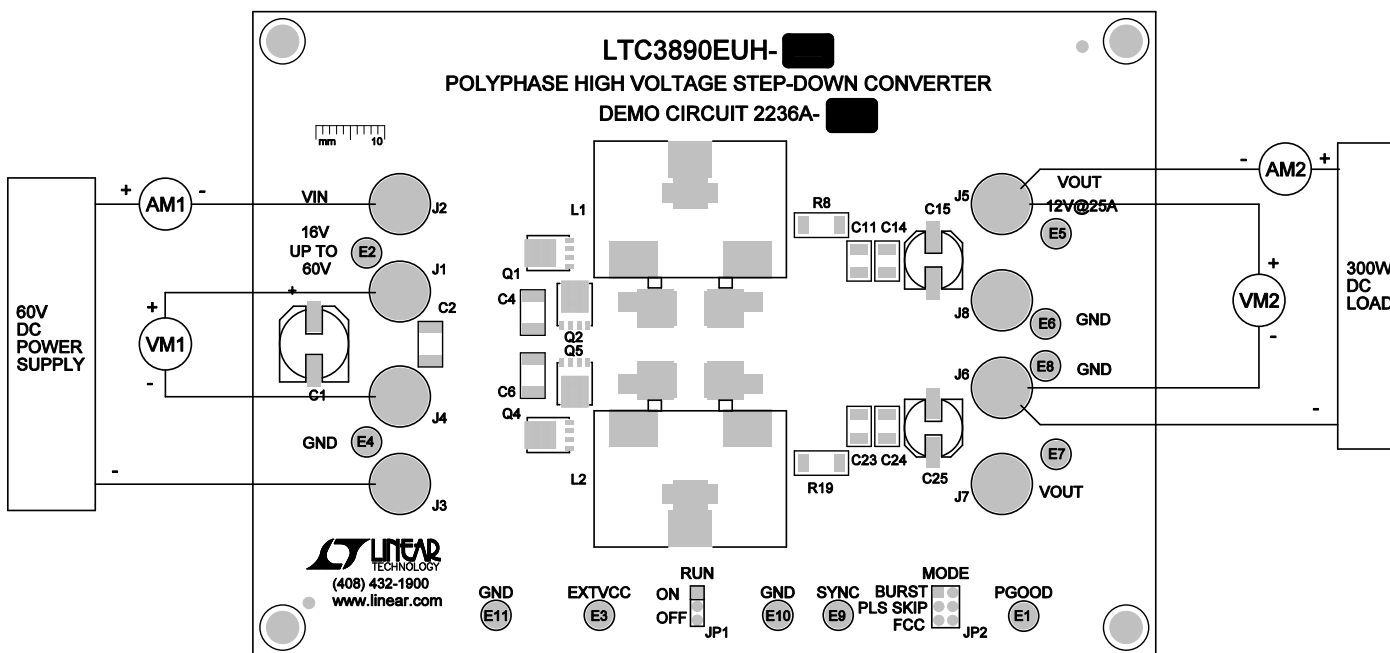

Figure 1. Proper Measurement Equipment Setup

QUICK START PROCEDURE

Table 1. Summary of the Differences Between the Parts in the LTC3890 Family

| | LTC3890 | LTC3890-1 | LTC3890-2 | LTC3890-3 |
|---|---|---|---|---|
| I _{LIM} Pin for Adjustable Current Sense Voltage? | Yes | No | Yes | No |
| CLKOUT and PHASMD Pins for PolyPhase® Operation? | Yes | No | Yes | No |
| Independent PGOOD Pins for Each Channel | Yes; PGOOD1 and PGOOD2 | No; PGOOD1 Only | Yes; PGOOD1 and PGOOD2 | No; PGOOD1 Only |
| Overvoltage Protection Bottom Gate “Crowbar?” | Yes | Yes | No; BG Not Forced On | No; BG Not Forced On |
| Current Foldback During Overcurrent Events | Yes | Yes | No | No |
| Light Load Operation When Synchronized to External Clock Using PLLIN/MODE Pin | Forced Continuous | Forced Continuous | Pulse-Skipping | Pulse-Skipping |
| SENSE Pins Common Mode Range | Operation with SENSE Common Mode < 0.5V Requires V _{FB} < 0.65V | Operation with SENSE Common Mode < 0.5V Requires V _{FB} < 0.65V | Not Dependent on V _{FB} Voltage. Makes It Easy to Make a Non-synchronous Boost or SEPIC Converter with Ground-Referenced Current Sensing | Not Dependent on V _{FB} Voltage. Makes It Easy to Make a Non-synchronous Boost or SEPIC Converter with Ground-Referenced Current Sensing |

QUICK START PROCEDURE

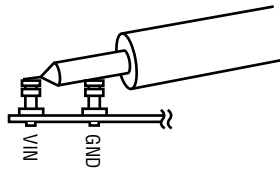

Figure 2. Measuring Input or Output Ripple

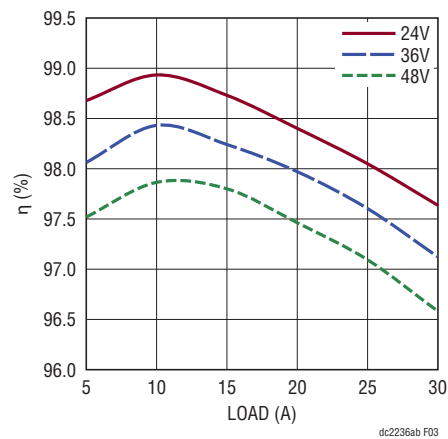

Figure 3. Efficiency vs Load

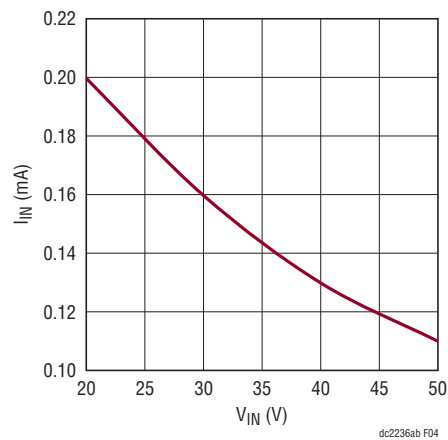

Figure 4. Input Current at No Load vs Input Voltage (Burst Mode)

QUICK START PROCEDURE

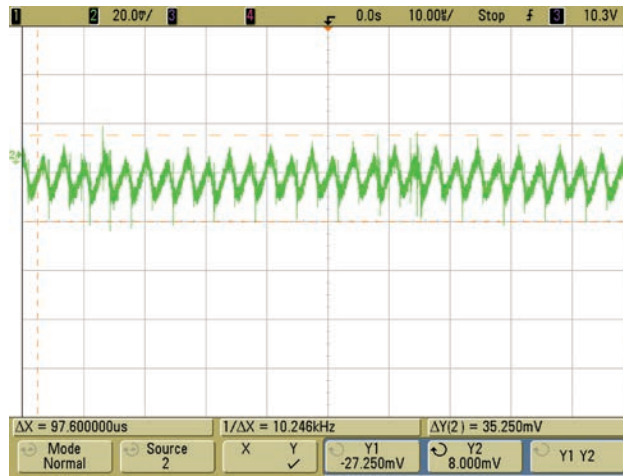

Figure 5. Output Noise, V_{IN} 36V, I_O 12A

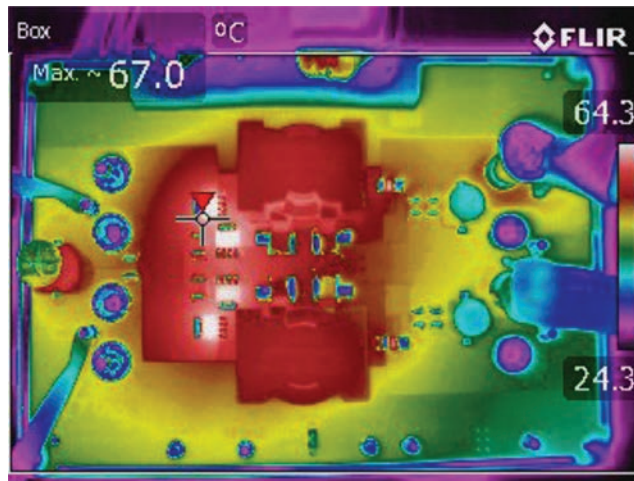

Figure 6. Thermal Map, V_{IN} 48V, V_O 12V, I_O 25A, No Air Flow

DEMO MANUAL DC2236A-B

PARTS LIST

| ITEM | QTY | REFERENCE | PART DESCRIPTION | MANUFACTURER/PART NUMBER |
|---|-----|---------------------------------|--------------------------------------|-----------------------------------|
| Required Circuit Components | | | | |
| 1 | 2 | C1, C29 | CAP., ALUM., 56µF, 63V, 20% | SUN ELECT., 63HVH56M |
| 2 | 6 | C2, C3, C4, C5, C6, C7 | CAP., X7R, 2.2µF, 100V, 10%, 1812 | TDK, C4532X7R2A225K |
| 3 | 2 | C8, C26 | CAP., NPO, 2.2pF, 50V, ±0.25pF, 0603 | AVX, 06035A2R2CAT |
| 4 | 1 | C9 | CAP., X7S, 1µF, 100V, 10%, 0805 | TDK, C2012X7S2A105K330 |
| 5 | 4 | C11, C14, C23, C24 | CAP., X5R, 10µF, 50V, 1210, 20% | TAIYO YUDEN, UMK325BJ106MM-T |
| 6 | 3 | C12, C16, C21 | CAP., X7R, 0.1µF, 50V, 10%, 0603 | TDK, C1608X7R1H104K |
| 7 | 2 | C15, C25 | CAP., Sanyo, 150µF, 16V, 20% | SANYO, 16TSVPC150 |
| 8 | 1 | C17 | CAP., X7R, 4.7nF, 100V, 10%, 0603 | AVX, 06031C472KAT |
| 9 | 2 | C18, C19 | CAP., NPO, 47pF, 25V, 10%, 0603 | AVX, 06033A470KAT2A |
| 10 | 2 | C20 | CAP., X7R, 4.7µF, 10V, 10%, 0603 | TAIYO YUDEN, LMK107BJ475KA-T |
| 11 | 1 | C22 | CAP., NPO, 10pF, 25V, 10%, 0603 | AVX, 06033A100KAT2A |
| 12 | 1 | C27 | CAP., X5R, 1µF, 25V, 10%, 0603 | AVX, 06033D105KAT2A |
| 13 | 2 | D1, D2 | DIODE, SCHOTTKY, DFSL1100, PDI-123 | DIODES, INC., DFSL1100 |
| 14 | 2 | L1, L2 | IND., 10µH, SMD | COILCRAFT SER2915L-103KL |
| 15 | 2 | Q1, Q4 | RENESAS, N CH POWER MOS FET | RENESAS, RJK0651DPB |
| 16 | 2 | Q2, Q5 | RENESAS, N CH POWER MOS FET | RENESAS, RJK0653DPB |
| 17 | 1 | R1 | RES., 2.2Ω 1%, 1/10W, 0603 | VISHAY, CRCW06032R20FNEA |
| 18 | 2 | R4, R22 | RES., 100Ω 1%, 1/10W, 0603 | VISHAY, CRCW0603100RFKEA |
| 19 | 6 | R2, R10, R14, R15, R24, R27 | RES., 0Ω, 1/10W, 0603 | VISHAY, CRCW06030000Z0EA |
| 20 | 1 | R6 | RES., 1M, 5%, 0805 | VISHAY, CRCW08051M00JNED |
| 21 | 1 | R7 | RES., 30.1k, 1%, 1/10W, 0603 | VISHAY, CRCW060330K1FKEA |
| 22 | 2 | R8, R19 | RES., 0.003Ω, 1%, 1/2W, 2010 | VISHAY, WSL20103L000FEA |
| 23 | 1 | R9 | RES., 57.6k, 1%, 1/10W, 0603 | VISHAY, CRCW060357K6FKEA |
| 24 | 2 | R12, R18 | RES., 0Ω, 1/10W, 0805 | VISHAY, CRCW08050000Z0EA |
| 25 | 1 | R13 | RES., 9.76k, 1%, 1/10W, 0603 | VISHAY, CRCW060315K0FKEA |
| 26 | 1 | R16 | RES., 499k, 1%, 1/10W, 0603 | VISHAY, CRCW0603499KFKEA |
| 27 | 1 | R20 | RES., 35.7k, 1%, 1/10W, 0603 | VISHAY, CRCW060335K7FKEA |
| 28 | 2 | R21, R29 | RES., 100k, 1%, 1/10W, 0603 | VISHAY, CRCW0603100KFKEA |
| 29 | 1 | R28 | RES., 1k, 1%, 1/10W, 0603 | VISHAY, CRCW06031K00FKEA |
| 30 | 1 | U1 | I.C., LTC3890EUH, QFN-32-UH | LINEAR TECH. LTC3890EUH |
| Additional Demo Board Circuit Components | | | | |
| 1 | 0 | R3, R5, C10, C13, R25, R26, C28 | OPT | 0603 PACKAGE |
| 2 | 0 | Q3, Q6, Q7, Q8 | OPT | LFPACK PACKAGE |
| Hardware: For Demo Board Only | | | | |
| 1 | 11 | E1-E11 | TESTPOINT, TURRET, 0.094" | MILL-MAX, 2501-2-00-80-00-00-07-0 |
| 2 | 2 | JP1, JP2 | JMP, 3PIN 1 ROW, 0.079" | SAMTEC, TMM-103-02-L-S |
| 3 | 2 | XJP1, XJP2 | SHUNT, 0.079" CENTER | SAMTEC, 2SN-BK-G |
| 4 | 7 | J1-J8 | CONNECTOR, BANANA JACK | KEYSTONE, 575-4 |
| 5 | 4 | MTGS AT 4 CORNERS | STANDOFF, NYLON 0.5 1/2" | KEYSTONE, 8833(SNAP-ON) |

SCHEMATIC DIAGRAM

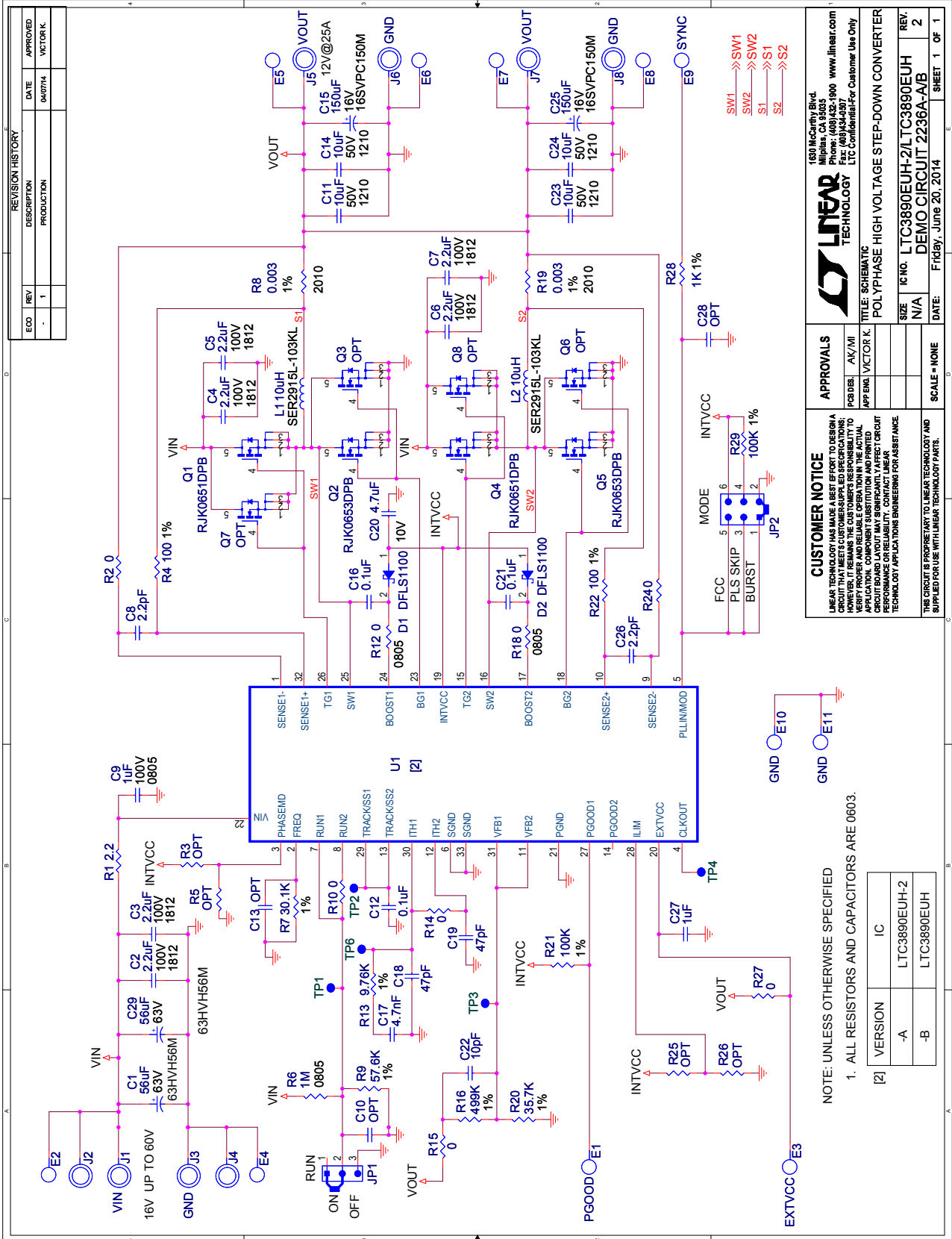

DEMO MANUAL DC2236A-B

DEMONSTRATION BOARD IMPORTANT NOTICE

Linear Technology Corporation (LTC) provides the enclosed product(s) under the following **AS IS** conditions:

This demonstration board (DEMO BOARD) kit being sold or provided by Linear Technology is intended for use for **ENGINEERING DEVELOPMENT OR EVALUATION PURPOSES ONLY** and is not provided by LTC for commercial use. As such, the DEMO BOARD herein may not be complete in terms of required design-, marketing-, and/or manufacturing-related protective considerations, including but not limited to product safety measures typically found in finished commercial goods. As a prototype, this product does not fall within the scope of the European Union directive on electromagnetic compatibility and therefore may or may not meet the technical requirements of the directive, or other regulations.

If this evaluation kit does not meet the specifications recited in the DEMO BOARD manual the kit may be returned within 30 days from the date of delivery for a full refund. **THE FOREGOING WARRANTY IS THE EXCLUSIVE WARRANTY MADE BY THE SELLER TO BUYER AND IS IN LIEU OF ALL OTHER WARRANTIES, EXPRESSED, IMPLIED, OR STATUTORY, INCLUDING ANY WARRANTY OF MERCHANTABILITY OR FITNESS FOR ANY PARTICULAR PURPOSE. EXCEPT TO THE EXTENT OF THIS INDEMNITY, NEITHER PARTY SHALL BE LIABLE TO THE OTHER FOR ANY INDIRECT, SPECIAL, INCIDENTAL, OR CONSEQUENTIAL DAMAGES.**

The user assumes all responsibility and liability for proper and safe handling of the goods. Further, the user releases LTC from all claims arising from the handling or use of the goods. Due to the open construction of the product, it is the user's responsibility to take any and all appropriate precautions with regard to electrostatic discharge. Also be aware that the products herein may not be regulatory compliant or agency certified (FCC, UL, CE, etc.).

No License is granted under any patent right or other intellectual property whatsoever. **LTC assumes no liability for applications assistance, customer product design, software performance, or infringement of patents or any other intellectual property rights of any kind.**

LTC currently services a variety of customers for products around the world, and therefore this transaction **is not exclusive**.

Please read the DEMO BOARD manual prior to handling the product. Persons handling this product must have electronics training and observe good laboratory practice standards. **Common sense is encouraged.**

This notice contains important safety information about temperatures and voltages. For further safety concerns, please contact a LTC application engineer.

Mailing Address:

Linear Technology
1630 McCarthy Blvd.
Milpitas, CA 95035

Copyright © 2004, Linear Technology Corporation