

**System pitch 5.08 mm (0.200 inch)
SL-SMT 5.08/03/90G 3.2SN BK BX**

Weidmüller Interface GmbH & Co. KG
Klingenbergstraße 16
D-32758 Detmold
Germany
Fon: +49 5231 14-0
Fax: +49 5231 14-2083
www.weidmueller.com



High-temperature-resistant male connector, packed in box or tape. In tape with 1.5 mm solder pin optimised for automatic assembly. 3.2 mm solder pin suitable for reflow and wave soldering. These male connectors can be labelled and coded.

- 400 V (IEC) / 300 V (UL)
- 19 A (IEC) / 15 A (UL)

General ordering data

Order No.	1780190000
Part designation	SL-SMT 5.08/03/90G 3.2SN BK BX
Version	PCB plug-in connector, male header, 5.08 mm, No. of poles: 3, 90°, Solder pin length: 3.2 mm, tinned, black, Reflow solder connection, Box
GTIN (EAN)	4032248165513
Qty.	100 pc(s).
Packaging	Box

System pitch 5.08 mm (0.200 inch) SL-SMT 5.08/03/90G 3.2SN BK BX

Weidmüller Interface GmbH & Co. KG
Klingenbergstraße 16
D-32758 Detmold
Germany
Fon: +49 5231 14-0
Fax: +49 5231 14-2083
www.weidmueller.com

Technical data

System parameters

Fitted to PCB	Reflow solder connection	Outgoing elbow	90°
Pitch in mm	5.08 mm	Pitch in inch	0.2 inch
No. of poles	3	Solder pin length	3.2 mm
Can be coded	Yes	No. of rows	1
Number of solder pins per pole	1	L1 in mm	10.16 mm
L1 in inch	0.4 inch		

Material data

Insulating material	LCP GF	Colour	black
Insulating material group	IIIa	Flammability class UL 94	V-0
Contact material	CuSn	Contact surface	tinned
Highest continuous operating temperature, min.	-25 °C	Highest continuous operating temperature, max.	100 °C
Max. relative humidity during storage	80 %		

DIN IEC rating data

Rated current, min. No. of poles (Tu=20°C)	19 A	Rated current, max. No. of poles (Tu=20°C)	15 A
Rated current, no. of poles (Tu=40°C), min.	16 A	Rated current, no. of poles (Tu=40°C), max.	13 A
Rated voltage at overvoltage category/pollution degree III/3	250 V	Rated impulse withstand voltage for overvoltage class/pollution severity III/3	4 kV
Rated voltage for overvoltage class/pollution severity III/2	320 V	Rated impulse withstand voltage for overvoltage class/pollution severity III/2	4 kV
Rated voltage for overvoltage class/pollution severity II/2	400 V	Rated impulse withstand voltage for overvoltage class/pollution severity II/2	4 kV

CSA rating data

Rated voltage (Use group B)	300 V	Rated current (use group B)	15 A
Rated voltage (use group D)	300 V	Rated current (use group D)	10 A

UL 1059 rating data

Rated voltage (use group B)	300 V	Rated current (use group B)	15 A
Rated voltage (use group D)	300 V	Rated current (use group D)	10 A

Approvals

Approvals institutes	CSA; GOSTME25; UR; ROHS
----------------------	-------------------------

Classifications

ETIM 3.0	EC001284	eClass 5.1	27-26-07-04
eClass 6.0	27-26-07-04		

Datasheet

System pitch 5.08 mm (0.200 inch)
SL-SMT 5.08/03/90G 3.2SN BK BX

Weidmüller Interface GmbH & Co. KG
Klingenbergstraße 16
D-32758 Detmold
Germany
Fon: +49 5231 14-0
Fax: +49 5231 14-2083
www.weidmueller.com

Technical data**Notes**

Notes

- Additional colours on request
- Gold-plated contact surfaces on request
- Rated current related to rated cross-section and min. No. of poles.
- Diameter of solder eyelet $D = 1.4 \pm 0.1$ mm
- Diameter of solder eyelet $D = 1.5 \pm 0.1$ mm from 9-pole
- P on drg. = pitch
- Rated data refer only to the component itself. Clearance and creepage distances to other components are to be designed in accordance with the relevant application standards.

Datasheet

System pitch 5.08 mm (0.200 inch)
SL-SMT 5.08/03/90G 3.2SN BK BX

Weidmüller Interface GmbH & Co. KG
Klingenbergstraße 16
D-32758 Detmold
Germany
Fon: +49 5231 14-0
Fax: +49 5231 14-2083
www.weidmueller.com

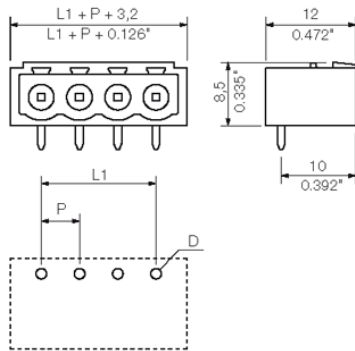
Drawings

System pitch 5.08 mm (0.200 inch) SL-SMT 5.08/03/90G 3.2SN BK BX

Weidmüller Interface GmbH & Co. KG
Klingenbergstraße 16
D-32758 Detmold
Germany
Fon: +49 5231 14-0
Fax: +49 5231 14-2083
www.weidmueller.com

Counterpart

BLZP 5.08/225 SN



Clamping-yoke wire connection with right-angled (90° or 270°) or angled (225°) outlet direction. The female connectors provide space for labelling and can be coded. Can be fastened with flange or release latch. They feature an integrated plus/minus screw, protection against false insertion under clamping yoke. They are delivered with an opened clamping yoke.

- 0.2-2.5 mm² (IEC) / 26-12 AWG (UL)
- 400 V (IEC) / 300 V (UL)
- 17.5 A (IEC) / 10 A (UL)

General ordering data

Order No.	Part designation	Version	GTIN (EAN)	Qty.	Packaging
1946570000	BLZP 5.08/03/225 SN BK BX	PCB plug-in connector, female plug, 5.08 mm, No. of poles: 3, 225°, Clamping yoke connection, Clamping range, max.: 4 mm ² , Box	4032248622344	120 pc(s).	Box
1946260000	BLZP 5.08/03/225 SN OR BX	PCB plug-in connector, female plug, 5.08 mm, No. of poles: 3, 225°, Clamping yoke connection, Clamping range, max.: 4 mm ² , Box	4032248621835	120 pc(s).	Box

BLZP 5.08/180 SN



Female connectors with clamping yoke screw connection for conductor connection with straight (180°) outlet direction. The female connectors provide space for labelling and can be coded. Can be fastened with flange or release latch. They feature an integrated plus/minus screw, protection against false insertion under clamping yoke. They are delivered with an opened clamping yoke.

- 0.2-2.5 mm² (IEC) / 26-12 AWG (UL)
- 400 V (IEC) / 300 V (UL)
- 19 A (IEC) / 15 A (UL)

General ordering data

Order No.	Part designation	Version	GTIN (EAN)	Qty.	Packaging
1943590000	BLZP 5.08/03/180 SN OR BX	PCB plug-in connector, female plug, 5.08 mm, No. of poles: 3, 180°, Clamping yoke connection, Clamping range, max.: 4 mm ² , Box	4032248617579	100 pc(s).	Box
1943820000	BLZP 5.08/03/180 SN BK BX	PCB plug-in connector, female plug, 5.08 mm, No. of poles: 3, 180°, Clamping yoke connection, Clamping range, max.: 4 mm ² , Box	4032248617845	100 pc(s).	Box

System pitch 5.08 mm (0.200 inch) SL-SMT 5.08/03/90G 3.2SN BK BX

Weidmüller Interface GmbH & Co. KG
 Klingenbergstraße 16
 D-32758 Detmold
 Germany
 Fon: +49 5231 14-0
 Fax: +49 5231 14-2083
 www.weidmueller.com

Counterpart

BLZP 5.00/270 SN

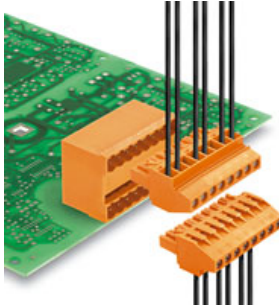

Socket connectors with clamping yoke screw connection for conductor connection with a right-angle (90° or 270°) outlet direction. The female connectors provide space for labelling and can be coded. Can be fastened with flange or release latch. They feature an integrated plus/minus screw, protection against false insertion under clamping yoke. They are delivered with an opened clamping yoke.

- 0.2-2.5 mm² (IEC) / 26-12 AWG (UL)
- 400 V (IEC) / 300 V (UL)
- 15 A (IEC) / 10 A (UL)

General ordering data

Order No.	Part designation	Version	GTIN (EAN)	Qty.	Packaging
1959090000	BLZP 5.00/03/270 SN BK BX	PCB plug-in connector, female plug, 5.00 mm, No. of poles: 3, 90°, Clamping yoke connection, Clamping range, max.: 4 mm ² , Box	4032248638024	120 pc(s).	Box
1958860000	BLZP 5.00/03/270 SN OR BX	PCB plug-in connector, female plug, 5.00 mm, No. of poles: 3, 90°, Clamping yoke connection, Clamping range, max.: 4 mm ² , Box	4032248637690	120 pc(s).	Box

BLF 5.08/90 SN



Just as reliable as the tried-and-true original, with innovation in detail:

The BLF 5.0x – the PUSH-IN version of the BLZ 5.0x socket block – features a new connection system and a more compact design. Weidmüller's innovative PUSH-IN spring connection features a trend-setting, tool-free wire connection system that is simple to operate.

In terms of versatility, the BLF 5.0x offers just as much as the older versions:

- The choice of three wire outlet directions offers you proven design flexibility for your applications.
- Four flange variations, including the patented release latch, allow for user-friendly unplugging designs.

General ordering data

Order No.	Part designation	Version	GTIN (EAN)	Qty.	Packaging
1000040001	BLF 5.08/03/90 SN BK BX	PCB plug-in connector, female plug, 5.08 mm, No. of poles: 3, 90°, PUSH IN, Clamping range, max.: 3.31 mm ² , Box	4032248689972	120 pc(s).	Box
1001540000	BLF 5.08/03/90 SN OR BX	PCB plug-in connector, female plug, 5.08 mm, No. of poles: 3, 90°, PUSH IN, Clamping range, max.: 3.31 mm ² , Box	4032248693344	120 pc(s).	Box

System pitch 5.08 mm (0.200 inch) SL-SMT 5.08/03/90G 3.2SN BK BX

Weidmüller Interface GmbH & Co. KG
 Klingenbergstraße 16
 D-32758 Detmold
 Germany
 Fon: +49 5231 14-0
 Fax: +49 5231 14-2083
 www.weidmueller.com

Counterpart

BLL 5.08/180



Female connector for PCB mounting. The solder pin length is optimised for wave flow soldering. Packed in cardboard box.

- 400 V (IEC) / 300 V (UL)
- 23 A (IEC) / 15 A (UL)

General ordering data

Order No.	Part designation	Version	GTIN (EAN)	Qty.	Packaging
1630720000	BLL 5.08/03/180 3.2SN OR BX	PCB plug-in connector, female header, 5.08 mm, No. of poles: 3, 180°, Solder pin length: 3.2 mm, tinned, Orange, Solder connection, Box	4008190204143	100 pc(s).	Box

BLZ 5.00/270



Female connectors with clamping yoke screw connection. The female connectors provide space for labelling and can be coded. Packed in cardboard box.

- 0.20 - 2.5 mm² (IEC) / 26 - 12 AWG (UL)
- 400 V (IEC) / 300 V (UL)
- 15 A (IEC) / 10 A (UL)

General ordering data

Order No.	Part designation	Version	GTIN (EAN)	Qty.	Packaging
1637590000	BLZ 5.00/03/270 SN OR BX	PCB plug-in connector, female plug, 5.00 mm, No. of poles: 3, 270°, Clamping yoke connection, Clamping range, max.: 3.31 mm ² , Box	4008190274832	120 pc(s).	Box
1637820000	BLZ 5.00/03/270 SN BK BX	PCB plug-in connector, female plug, 5.00 mm, No. of poles: 3, 270°, Clamping yoke connection, Clamping range, max.: 3.31 mm ² , Box	4008190275068	120 pc(s).	Box

System pitch 5.08 mm (0.200 inch) SL-SMT 5.08/03/90G 3.2SN BK BX

Weidmüller Interface GmbH & Co. KG
 Klingenbergstraße 16
 D-32758 Detmold
 Germany
 Fon: +49 5231 14-0
 Fax: +49 5231 14-2083
 www.weidmueller.com

Counterpart

BLZF 5.08/180



Female connectors for connecting conductors with tension clamp system, straight 180° outlet direction. The female connectors include space for labelling and can be coded. Packed in cardboard box.

- 0.20 - 2.5 mm² (IEC) / 26 - 12 AWG (UL)
- 400 V (IEC) / 300 V (UL)
- 17 A (IEC) / 15 A (UL)

General ordering data

Order No.	Part designation	Version	GTIN (EAN)	Qty.	Packaging
170770000	BLZF 5.08/03/180 SN BK BX	PCB plug-in connector, female plug, 5.08 mm, No. of poles: 3, 180°, Tension clamp connection, Clamping range, max.: 3.31 mm ² , Box	4008190316709	120 pc(s).	Box
170747000	BLZF 5.08/03/180 SN OR BX	PCB plug-in connector, female plug, 5.08 mm, No. of poles: 3, 180°, Tension clamp connection, Clamping range, max.: 3.31 mm ² , Box	4008190395841	120 pc(s).	Box

BLF 5.00/90 SN



Just as reliable as the tried-and-true original, with innovation in detail:

The BLF 5.0x – the PUSH-IN version of the BLZ 5.0x socket block – features a new connection system and a more compact design. Weidmüller's innovative PUSH-IN spring connection features a trend-setting, tool-free wire connection system that is simple to operate.

In terms of versatility, the BLF 5.0x offers just as much as the older versions:

- The choice of three wire outlet directions offers you proven design flexibility for your applications.
- Four flange variations, including the patented release latch, allow for user-friendly unplugging designs.

General ordering data

Order No.	Part designation	Version	GTIN (EAN)	Qty.	Packaging
197928000	BLF 5.00/03/90 SN BK BX	PCB plug-in connector, female plug, 5.00 mm, No. of poles: 3, 90°, PUSH IN, Clamping range, max.: 3.31 mm ² , Box	4032248674459	120 pc(s).	Box
198018000	BLF 5.00/03/90 SN OR BX	PCB plug-in connector, female plug, 5.00 mm, No. of poles: 3, 90°, PUSH IN, Clamping range, max.: 3.31 mm ² , Box	4032248675265	120 pc(s).	Box

System pitch 5.08 mm (0.200 inch) SL-SMT 5.08/03/90G 3.2SN BK BX

Weidmüller Interface GmbH & Co. KG
Klingenbergstraße 16
D-32758 Detmold
Germany
Fon: +49 5231 14-0
Fax: +49 5231 14-2083
www.weidmueller.com

Counterpart

BLIDC 5.08



Female connectors for conductor connection with IDC system. The female connectors provide space for labelling and can be coded. Packed in cardboard box.

- 0.35 - 0.75 mm² (IEC) / 22 - 20 AWG (UL)
- 400 V (IEC) / 300 V (UL)
- 11 A (IEC) / 5 A (UL)

General ordering data

Order No.	Part designation	Version	GTIN (EAN)	Qty.	Packaging
1724950000	BLIDC 5.08/03/180 SN OR BX	PCB plug-in connector, female plug, 5.08 mm, No. of poles: 3, 180°, IDC terminal, Clamping range, max.: 0.75 mm ² , Box	4008190377298	100 pc(s).	Box

BLZP 5.00/90 SN



Socket connectors with clamping yoke screw connection for conductor connection with a right-angle (90° or 270°) outlet direction. The female connectors provide space for labelling and can be coded. Can be fastened with flange or release latch. They feature an integrated plus/minus screw, protection against false insertion under clamping yoke. They are delivered with an opened clamping yoke.

- 0.2-2.5 mm² (IEC) / 26-12 AWG (UL)
- 400 V (IEC) / 300 V (UL)
- 15 A (IEC) / 10 A (UL)

General ordering data

Order No.	Part designation	Version	GTIN (EAN)	Qty.	Packaging
1958640000	BLZP 5.00/03/90 SN BK BX	PCB plug-in connector, female plug, 5.00 mm, No. of poles: 3, 90°, Clamping yoke connection, Clamping range, max.: 4 mm ² , Box	4032248637379	120 pc(s).	Box
1958290000	BLZP 5.00/03/90 SN OR BX	PCB plug-in connector, female plug, 5.00 mm, No. of poles: 3, 90°, Clamping yoke connection, Clamping range, max.: 4 mm ² , Box	4032248637157	120 pc(s).	Box

System pitch 5.08 mm (0.200 inch) SL-SMT 5.08/03/90G 3.2SN BK BX

Weidmüller Interface GmbH & Co. KG
 Klingenbergstraße 16
 D-32758 Detmold
 Germany
 Fon: +49 5231 14-0
 Fax: +49 5231 14-2083
 www.weidmueller.com

Counterpart

BLZ 5.00/90

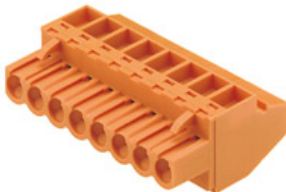

Female connectors with clamping yoke screw connection. The female connectors provide space for labelling and can be coded. Packed in cardboard box.

- 0.20 - 2.5 mm² (IEC) / 26 - 12 AWG (UL)
- 400 V (IEC) / 300 V (UL)
- 15 A (IEC) / 10 A (UL)

General ordering data

Order No.	Part designation	Version	GTIN (EAN)	Qty.	Packaging
1636900000	BLZ 5.00/03/90 SN BK BX	PCB plug-in connector, female plug, 5.00 mm, No. of poles: 3, 90°, Clamping yoke connection, Clamping range, max.: 3.31 mm ² , Box	4008190274146	120 pc(s).	Box
1635950000	BLZ 5.00/03/90 SN OR BX	PCB plug-in connector, female plug, 5.00 mm, No. of poles: 3, 90°, Clamping yoke connection, Clamping range, max.: 3.31 mm ² , Box	4008190265847	120 pc(s).	Box

BLZF 5.08/90



Female connectors for connecting conductors with tension clamp system. The female connectors include space for labelling and can be coded. Packed in cardboard box.

- 0.20 - 2.5 mm² (IEC) / 26 - 12 AWG (UL)
- 400 V (IEC) / 300 V (UL)
- 16.5 A (IEC) / 10 A (UL)

General ordering data

Order No.	Part designation	Version	GTIN (EAN)	Qty.	Packaging
1671030000	BLZF 5.08/03/90 SN BK BX	PCB plug-in connector, female plug, 5.08 mm, No. of poles: 3, 90°, Tension clamp connection, Clamping range, max.: 3.31 mm ² , Box	4008190432706	120 pc(s).	Box
1670800000	BLZF 5.08/03/90 SN OR BX	PCB plug-in connector, female plug, 5.08 mm, No. of poles: 3, 90°, Tension clamp connection, Clamping range, max.: 3.31 mm ² , Box	4008190432409	120 pc(s).	Box

**System pitch 5.08 mm (0.200 inch)
SL-SMT 5.08/03/90G 3.2SN BK BX**

Weidmüller Interface GmbH & Co. KG
Klingenbergstraße 16
D-32758 Detmold
Germany
Fon: +49 5231 14-0
Fax: +49 5231 14-2083
www.weidmueller.com

Counterpart
BL 5.00

Female connectors for conductor connection in leaf spring system. Packed in cardboard box. The female connectors provide space for labelling. Packed in cardboard box.

- 0.2 - 1.5 mm² (IEC) / 26 - 14 AWG (UL)
- 400 V (IEC) / 300 V (UL)
- 11 A (IEC) / 10 A (UL)

General ordering data

Order No.	Part designation	Version	GTIN (EAN)	Qty.	Packaging
1723120000	BL 5.00/03/180 SN OR BX	PCB plug-in connector, female plug, 5.00 mm, No. of poles: 3, 180°, Leaf spring connection, Clamping range, max.: 2.08 mm ² , Box	4032248002528	100 pc(s).	Box
1730710000	BL 5.00/03/180 SN BK BX	PCB plug-in connector, female plug, 5.00 mm, No. of poles: 3, 180°, Leaf spring connection, Clamping range, max.: 2.08 mm ² , Box	4008190387327	100 pc(s).	Box

BLZP 5.00/180 SN

Female connectors with clamping yoke screw connection for conductor connection with straight (180°) outlet direction. The female connectors provide space for labelling and can be coded. Can be fastened with flange or release latch. They feature an integrated plus/minus screw, protection against false insertion under clamping yoke. They are delivered with an opened clamping yoke.

- 0.2-2.5 mm² (IEC) / 26-12 AWG (UL)
- 400 V (IEC) / 300 V (UL)
- 19 A (IEC) / 15 A (UL)

General ordering data

Order No.	Part designation	Version	GTIN (EAN)	Qty.	Packaging
1955560000	BLZP 5.00/03/180 SN BK BX	PCB plug-in connector, female plug, 5.00 mm, No. of poles: 3, 180°, Clamping yoke connection, Clamping range, max.: 4 mm ² , Box	4032248634057	100 pc(s).	Box
1954480000	BLZP 5.00/03/180 SN OR BX	PCB plug-in connector, female plug, 5.00 mm, No. of poles: 3, 180°, Clamping yoke connection, Clamping range, max.: 4 mm ² , Box	4032248633197	100 pc(s).	Box

System pitch 5.08 mm (0.200 inch) SL-SMT 5.08/03/90G 3.2SN BK BX

Weidmüller Interface GmbH & Co. KG
 Klingenbergstraße 16
 D-32758 Detmold
 Germany
 Fon: +49 5231 14-0
 Fax: +49 5231 14-2083
 www.weidmueller.com

Counterpart

BLZP 5.08/270 SN

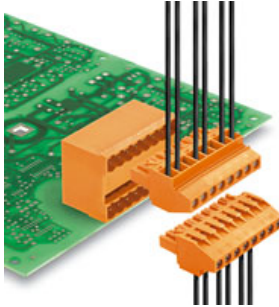

Socket connectors with clamping yoke screw connection for conductor connection with a right-angle (90° or 270°) outlet direction. The female connectors provide space for labelling and can be coded. Can be fastened with flange or release latch. They feature an integrated plus/minus screw, protection against false insertion under clamping yoke. They are delivered with an opened clamping yoke.

- 0.2-2.5 mm² (IEC) / 26-12 AWG (UL)
- 400 V (IEC) / 300 V (UL)
- 15 A (IEC) / 10 A (UL)

General ordering data

Order No.	Part designation	Version	GTIN (EAN)	Qty.	Packaging
1948800000	BLZP 5.08/03/270 SN OR BX	PCB plug-in connector, female plug, 5.08 mm, No. of poles: 3, 270°, Clamping yoke connection, Clamping range, max.: 4 mm ² , Box	4032248626250	120 pc(s).	Box
1949030000	BLZP 5.08/03/270 SN BK BX	PCB plug-in connector, female plug, 5.08 mm, No. of poles: 3, 270°, Clamping yoke connection, Clamping range, max.: 4 mm ² , Box	4032248626489	120 pc(s).	Box

BLZFS 5.00/180



Female connectors for connecting conductors with tension clamp system, straight 180° outlet direction in thin-element design. The female connectors include space for labelling and can be coded. Packed in cardboard box.

- 0.20 - 2.5 mm² (IEC) / 26 - 14 AWG (UL)
- 400 V (IEC) / 300 V (UL)
- 17 A (IEC) / 10 A (UL)

General ordering data

Order No.	Part designation	Version	GTIN (EAN)	Qty.	Packaging
1696380000	BLZFS 5.00/03/180 SN OR BX	PCB plug-in connector, female plug, 5.00 mm, No. of poles: 3, 180°, Tension clamp connection, Clamping range, max.: 2.5 mm ² , Box	4008190878405	100 pc(s).	Box
1696610000	BLZFS 5.00/03/180 SN BK BX	PCB plug-in connector, female plug, 5.00 mm, No. of poles: 3, 180°, Tension clamp connection, Clamping range, max.: 2.5 mm ² , Box	4008190878634	100 pc(s).	Box

System pitch 5.08 mm (0.200 inch) SL-SMT 5.08/03/90G 3.2SN BK BX

Weidmüller Interface GmbH & Co. KG
 Klingenbergstraße 16
 D-32758 Detmold
 Germany
 Fon: +49 5231 14-0
 Fax: +49 5231 14-2083
 www.weidmueller.com

Counterpart

BL 5.08



Female connectors for conductor connection in leaf spring system. Packed in cardboard box. The female connectors provide space for labelling. Packed in cardboard box.

- 0.2 - 1.5 mm² (IEC) / 26 - 14 AWG (UL)
- 400 V (IEC) / 300 V (UL)
- 11 A (IEC) / 10 A (UL)

General ordering data

Order No.	Part designation	Version	GTIN (EAN)	Qty.	Packaging
1716480000	BL 5.08/03/180 SN BK BX	PCB plug-in connector, female plug, 5.08 mm, No. of poles: 3, 180°, Leaf spring connection, Clamping range, max.: 2.08 mm ² , Box	4008190376529	100 pc(s).	Box
1723840000	BL 5.08/03/180 SN DKGX BX	PCB plug-in connector, female plug, 5.08 mm, No. of poles: 3, 180°, Leaf spring connection, Clamping range, max.: 2.08 mm ² , Box	4008190376208	100 pc(s).	Box
1716330000	BL 5.08/03/180 SN OR BX	PCB plug-in connector, female plug, 5.08 mm, No. of poles: 3, 180°, Leaf spring connection, Clamping range, max.: 2.08 mm ² , Box	4008190376369	100 pc(s).	Box

BLT 5.08

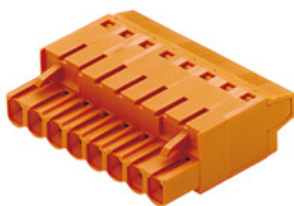

Female connectors with TOP screw system for connecting conductors with straight 180° outlet direction. The female connectors include space for labelling and can be coded. Packed in cardboard box.

- 0.20 - 2.5 mm² (IEC) / 26 - 14 AWG (UL)
- 400 V (IEC) / 300 V (UL)
- 17 A (IEC) / 10 A (UL)

General ordering data

Order No.	Part designation	Version	GTIN (EAN)	Qty.	Packaging
1499610000	BLT 5.08/03/180 SN BK BX	PCB plug-in connector, female plug, 5.08 mm, No. of poles: 3, 180°, TOP connection, Clamping range, max.: 2.5 mm ² , Box	4008190401559	120 pc(s).	Box
1499660000	BLT 5.08/03/180 SN OR BX	PCB plug-in connector, female plug, 5.08 mm, No. of poles: 3, 180°, TOP connection,	4008190008352	120 pc(s).	Box

System pitch 5.08 mm (0.200 inch) SL-SMT 5.08/03/90G 3.2SN BK BX

Weidmüller Interface GmbH & Co. KG
 Klingenbergstraße 16
 D-32758 Detmold
 Germany
 Fon: +49 5231 14-0
 Fax: +49 5231 14-2083
 www.weidmueller.com

Counterpart

Clamping range, max.: 2.5 mm², Box

BLZ 5.00/180



Female connectors with clamping yoke screw connection for conductor connection with straight outlet direction. The female connectors provide space for labelling and can be coded. Packed in cardboard box.

- 0.20 - 2.5 mm² (IEC) / 26 - 12 AWG (UL)
- 400 V (IEC) / 300 V (UL)
- 19 A (IEC) / 15 A (UL)

General ordering data

Order No.	Part designation	Version	GTIN (EAN)	Qty.	Packaging
1625620000	BLZ 5.00/03/180 SN BK BX	PCB plug-in connector, female plug, 5.00 mm, No. of poles: 3, 180°, Clamping yoke connection, Clamping range, max.: 3.31 mm ² , Box	4008190196929	100 pc(s).	Box
1571360000	BLZ 5.00/03/180 SN OR BX	PCB plug-in connector, female plug, 5.00 mm, No. of poles: 3, 180°, Clamping yoke connection, Clamping range, max.: 3.31 mm ² , Box	4008190034979	100 pc(s).	Box

BLC 5.08R



Female connectors for conductor connection with crimp connection system. The female connectors provide space for labelling and can be coded. Packed in cardboard box.

- 0.25 - 2.5 mm² (IEC) / 26 - 14 AWG (UL)
- 400 V (IEC) / 300 V (UL)
- 21 A (IEC) / 10 A (UL)

General ordering data

Order No.	Part designation	Version	GTIN (EAN)	Qty.	Packaging
1610500000	BLC 5.08/03/180R OR BX	PCB plug-in connector, female plug, 5.08 mm, No. of poles: 3, 180°, Crimp connection, Clamping range, max.: 2.5 mm ² , Box	4008190004293	100 pc(s).	Box
1711970000	BLC 5.08/03/180R BK BX	PCB plug-in connector, female plug, 5.08 mm, No. of poles: 3, 180°, Crimp connection,	4008190934989	100 pc(s).	Box

System pitch 5.08 mm (0.200 inch) SL-SMT 5.08/03/90G 3.2SN BK BX

Weidmüller Interface GmbH & Co. KG
 Klingenbergstraße 16
 D-32758 Detmold
 Germany
 Fon: +49 5231 14-0
 Fax: +49 5231 14-2083
 www.weidmueller.com

Counterpart

Clamping range, max.: 2.5
mm², Box

BLZ 5.08/180



Female connectors with clamping yoke screw connection for conductor connection with straight outlet direction. The female connectors provide space for labelling and can be coded. Packed in cardboard box.

- 0.20 - 2.5 mm² (IEC) / 26 - 12 AWG (UL)
- 400 V (IEC) / 300 V (UL)
- 19 A (IEC) / 15 A (UL)

General ordering data

Order No.	Part designation	Version	GTIN (EAN)	Qty.	Packaging
1526560000	BLZ 5.08/03/180 SN OR BX	PCB plug-in connector, female plug, 5.08 mm, No. of poles: 3, 180°, Clamping yoke connection, Clamping range, max.: 3.31 mm ² , Box	4008190170004	100 pc(s).	Box
1526510000	BLZ 5.08/03/180 SN BK BX	PCB plug-in connector, female plug, 5.08 mm, No. of poles: 3, 180°, Clamping yoke connection, Clamping range, max.: 3.31 mm ² , Box	4008190151553	100 pc(s).	Box

BLDT 5.08

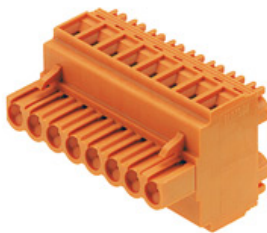

Female connectors with two clamping yoke screw connections per pole for conductor connection with 90° & 270° outlet direction. The female connectors provide space for labelling and can be coded. Packed in cardboard box.

- 0.20 - 2.5 mm² (IEC) / 26 - 12 AWG (UL)
- 400 V (IEC) / 300 V (UL)
- 14 A (IEC) / 10 A (UL)

General ordering data

Order No.	Part designation	Version	GTIN (EAN)	Qty.	Packaging
1660720000	BLDT 5.08/03/- SN BK BX	PCB plug-in connector, female plug, 5.08 mm, No. of poles: 3, 90°/270°, Clamping yoke connection, Clamping range, max.: 3.31 mm ² , Box	4008190417178	100 pc(s).	Box
1644740000	BLDT 5.08/03/- SN OR BX	PCB plug-in connector, female plug, 5.08 mm, No. of poles: 3, 90°/270°, Clamping yoke connection, Clamping range, max.: 3.31 mm ² , Box	4008190283957	100 pc(s).	Box

System pitch 5.08 mm (0.200 inch) SL-SMT 5.08/03/90G 3.2SN BK BX

Weidmüller Interface GmbH & Co. KG
 Klingenbergstraße 16
 D-32758 Detmold
 Germany
 Fon: +49 5231 14-0
 Fax: +49 5231 14-2083
 www.weidmueller.com

Counterpart

connection, Clamping range,
 max.: 3.31 mm², Box

BLZ 5.08/90



Female connectors with clamping yoke screw connection. The female connectors provide space for labelling and can be coded. Packed in cardboard box.

- 0.20 - 2.5 mm² (IEC) / 26 - 12 AWG (UL)
- 400 V (IEC) / 300 V (UL)
- 15 A (IEC) / 10 A (UL)

General ordering data

Order No.	Part designation	Version	GTIN (EAN)	Qty.	Packaging
1552810000	BLZ 5.08/03/90 SN BK BX	PCB plug-in connector, female plug, 5.08 mm, No. of poles: 3, 90°, Clamping yoke connection, Clamping range, max.: 3.31 mm ² , Box	4008190267711	120 pc(s).	Box
1552860000	BLZ 5.08/03/90 SN OR BX	PCB plug-in connector, female plug, 5.08 mm, No. of poles: 3, 90°, Clamping yoke connection, Clamping range, max.: 3.31 mm ² , Box	4008190000790	120 pc(s).	Box

BLL 5.08/90



Female connector for PCB mounting. The solder pin length is optimised for wave flow soldering. Packed in cardboard box.

- 400 V (IEC) / 300 V (UL)
- 23 A (IEC) / 15 A (UL)

General ordering data

Order No.	Part designation	Version	GTIN (EAN)	Qty.	Packaging
1622950000	BLL 5.08/03/90 3.2SN OR BX	PCB plug-in connector, female header, 5.08 mm, No. of poles: 3, 90°, Solder pin length: 3.2 mm, tinned, Orange, Solder connection, Box	4008190194031	100 pc(s).	Box

System pitch 5.08 mm (0.200 inch) SL-SMT 5.08/03/90G 3.2SN BK BX

Weidmüller Interface GmbH & Co. KG
 Klingenbergstraße 16
 D-32758 Detmold
 Germany
 Fon: +49 5231 14-0
 Fax: +49 5231 14-2083
 www.weidmueller.com

Counterpart

BLZ 5.08/225



Female connectors with clamping yoke screw connection for conductor connection with 225° outlet direction. The female connectors provide space for labelling and can be coded. Packed in cardboard box.

- 0.20 - 2.5 mm² (IEC) / 26 - 12 AWG (UL)
- 400 V (IEC) / 300 V (UL)
- 16.5 A (IEC) / 10 A (UL)

General ordering data

Order No.	Part designation	Version	GTIN (EAN)	Qty.	Packaging
1741650000	BLZ 5.08/03/225 SN OR BX	PCB plug-in connector, female plug, 5.08 mm, No. of poles: 3, 225°, Clamping yoke connection, Clamping range, max.: 3.31 mm ² , Box	4008190198244	120 pc(s).	Box
1741880000	BLZ 5.08/03/225 SN BK BX	PCB plug-in connector, female plug, 5.08 mm, No. of poles: 3, 225°, Clamping yoke connection, Clamping range, max.: 3.31 mm ² , Box	4008190249786	120 pc(s).	Box

BLZ 5.08/270



Female connectors with clamping yoke screw connection. The female connectors provide space for labelling and can be coded. Packed in cardboard box.

- 0.20 - 2.5 mm² (IEC) / 26 - 12 AWG (UL)
- 400 V (IEC) / 300 V (UL)
- 15 A (IEC) / 10 A (UL)

General ordering data

Order No.	Part designation	Version	GTIN (EAN)	Qty.	Packaging
1557410000	BLZ 5.08/03/270 SN BK BX	PCB plug-in connector, female plug, 5.08 mm, No. of poles: 3, 270°, Clamping yoke connection, Clamping range, max.: 3.31 mm ² , Box	4008190269432	120 pc(s).	Box
1557460000	BLZ 5.08/03/270 SN OR BX	PCB plug-in connector, female plug, 5.08 mm, No. of poles: 3, 270°, Clamping yoke connection, Clamping range, max.: 3.31 mm ² , Box	4008190147891	120 pc(s).	Box

Datasheet

System pitch 5.08 mm (0.200 inch)
SL-SMT 5.08/03/90G 3.2SN BK BX

Weidmüller Interface GmbH & Co. KG
 Klingenbergstraße 16
 D-32758 Detmold
 Germany
 Fon: +49 5231 14-0
 Fax: +49 5231 14-2083
 www.weidmueller.com

Counterpart

BLZF 5.08/270



Female connectors for connecting conductors with tension clamp system. The female connectors include space for labelling and can be coded. Packed in cardboard box.

- 0.20 - 2.5 mm² (IEC) / 26 - 12 AWG (UL)
- 400 V (IEC) / 300 V (UL)
- 16.5 A (IEC) / 10 A (UL)

General ordering data

Order No.	Part designation	Version	GTIN (EAN)	Qty.	Packaging
1671950000	BLZF 5.08/03/270 SN OR BX	PCB plug-in connector, female plug, 5.08 mm, No. of poles: 3, 270°, Tension clamp connection, Clamping range, max.: 3.31 mm ² , Box	4008190433666	120 pc(s).	Box
1672180000	BLZF 5.08/03/270 SN BK BX	PCB plug-in connector, female plug, 5.08 mm, No. of poles: 3, 270°, Tension clamp connection, Clamping range, max.: 3.31 mm ² , Box	4008190433895	120 pc(s).	Box

System pitch 5.08 mm (0.200 inch) SL-SMT 5.08/03/90G 3.2SN BK BX

Weidmüller Interface GmbH & Co. KG
 Klingenbergstraße 16
 D-32758 Detmold
 Germany
 Fon: +49 5231 14-0
 Fax: +49 5231 14-2083
 www.weidmueller.com

Counterpart

BLZP 5.08/270F SN



Socket connectors with clamping yoke screw connection for conductor connection with a right-angle (90° or 270°) outlet direction. The female connectors provide space for labelling and can be coded. Can be fastened with flange or release latch. They feature an integrated plus/minus screw, protection against false insertion under clamping yoke. They are delivered with an opened clamping yoke.

- 0.2-2.5 mm² (IEC) / 26-12 AWG (UL)
- 400 V (IEC) / 300 V (UL)
- 15 A (IEC) / 10 A (UL)

General ordering data

Order No.	Part designation	Version	GTIN (EAN)	Qty.	Packaging
1950320000	BLZP 5.08/03/270F SN OR BX	PCB plug-in connector, female plug, 5.08 mm, No. of poles: 3, 270°, Clamping yoke connection, Clamping range, max.: 4 mm ² , Box	4032248628438	72 pc(s).	Box
1950560000	BLZP 5.08/03/270F SN BK BX	PCB plug-in connector, female plug, 5.08 mm, No. of poles: 3, 270°, Clamping yoke connection, Clamping range, max.: 4 mm ² , Box	4032248628698	72 pc(s).	Box

BLZP 5.08/180F SN



Female connectors with clamping yoke screw connection for conductor connection with straight (180°) outlet direction. The female connectors provide space for labelling and can be coded. Can be fastened with flange or release latch. They feature an integrated plus/minus screw, protection against false insertion under clamping yoke. They are delivered with an opened clamping yoke.

- 0.2-2.5 mm² (IEC) / 26-12 AWG (UL)
- 400 V (IEC) / 300 V (UL)
- 19 A (IEC) / 15 A (UL)

General ordering data

Order No.	Part designation	Version	GTIN (EAN)	Qty.	Packaging
1944340000	BLZP 5.08/03/180F SN BK BX	PCB plug-in connector, female plug, 5.08 mm, No. of poles: 3, 180°, Clamping yoke connection, Clamping range, max.: 4 mm ² , Box	4032248618910	100 pc(s).	Box
1944100000	BLZP 5.08/03/180F SN OR BX	PCB plug-in connector, female plug, 5.08 mm, No. of poles: 3, 180°, Clamping yoke connection, Clamping range, max.: 4 mm ² , Box	4032248617487	100 pc(s).	Box

System pitch 5.08 mm (0.200 inch) SL-SMT 5.08/03/90G 3.2SN BK BX

Weidmüller Interface GmbH & Co. KG
 Klingenbergstraße 16
 D-32758 Detmold
 Germany
 Fon: +49 5231 14-0
 Fax: +49 5231 14-2083
 www.weidmueller.com

Counterpart

BLZP 5.00/270F SN

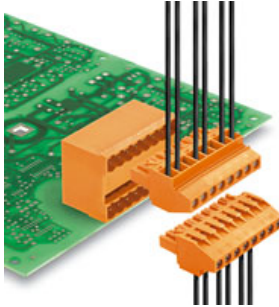

Socket connectors with clamping yoke screw connection for conductor connection with a right-angle (90° or 270°) outlet direction. The female connectors provide space for labelling and can be coded. Can be fastened with flange or release latch. They feature an integrated plus/minus screw, protection against false insertion under clamping yoke. They are delivered with an opened clamping yoke.

- 0.2-2.5 mm² (IEC) / 26-12 AWG (UL)
- 400 V (IEC) / 300 V (UL)
- 15 A (IEC) / 10 A (UL)

General ordering data

Order No.	Part designation	Version	GTIN (EAN)	Qty.	Packaging
1960720000	BLZP 5.00/03/270F SN BK BX	PCB plug-in connector, female plug, 5.00 mm, No. of poles: 3, 90°, Clamping yoke connection, Clamping range, max.: 4 mm ² , Box	4032248639717	72 pc(s).	Box
1960450000	BLZP 5.00/03/270F SN OR BX	PCB plug-in connector, female plug, 5.00 mm, No. of poles: 3, 90°, Clamping yoke connection, Clamping range, max.: 4 mm ² , Box	4032248639311	72 pc(s).	Box

BLZ 5.00/90B

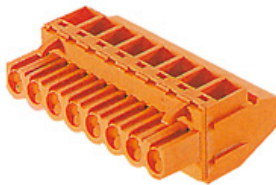

Female connectors with clamping yoke screw connection. The female connectors provide space for labelling and can be coded. Packed in cardboard box.

- 0.20 - 2.5 mm² (IEC) / 26 - 12 AWG (UL)
- 400 V (IEC) / 300 V (UL)
- 15 A (IEC) / 10 A (UL)

General ordering data

Order No.	Part designation	Version	GTIN (EAN)	Qty.	Packaging
1637360000	BLZ 5.00/03/90B SN BK BX	PCB plug-in connector, female plug, 5.00 mm, No. of poles: 3, 90°, Clamping yoke connection, Clamping range, max.: 3.31 mm ² , Box	4008190274603	108 pc(s).	Box
1637130000	BLZ 5.00/03/90B SN OR BX	PCB plug-in connector, female plug, 5.00 mm, No. of poles: 3, 90°, Clamping yoke connection, Clamping range, max.: 3.31 mm ² , Box	4008190274375	108 pc(s).	Box

System pitch 5.08 mm (0.200 inch) SL-SMT 5.08/03/90G 3.2SN BK BX

Weidmüller Interface GmbH & Co. KG
Klingenbergstraße 16
D-32758 Detmold
Germany
Fon: +49 5231 14-0
Fax: +49 5231 14-2083
www.weidmueller.com

Counterpart

BLZ 5.08/180LH



Socket connectors with clamping yoke screw connection for conductor connection with 270° outlet direction and release lever or release latch mechanism. The female connectors provide space for labelling and can be coded. Packed in cardboard box.br/>

- 0.20–1.5 mm² (IEC) / 26–12 AWG (UL)
- 400 V (IEC) / 300 V (UL)
- 19 A (IEC) / 15 A (UL)

General ordering data

Order No.	Part designation	Version	GTIN (EAN)	Qty.	Packaging
1893610000	BLZ 5.08/03/180LH SN BK BX	PCB plug-in connector, female plug, 5.08 mm, No. of poles: 3, 180°, Clamping yoke connection, Clamping range, max.: 3.31 mm ² , Box	4032248507795	100 pc(s).	Box
1892200000	BLZ 5.08/03/180LH SN OR BX	PCB plug-in connector, female plug, 5.08 mm, No. of poles: 3, 180°, Clamping yoke connection, Clamping range, max.: 3.31 mm ² , Box	4032248505524	100 pc(s).	Box

BLZP 5.08/90F SN

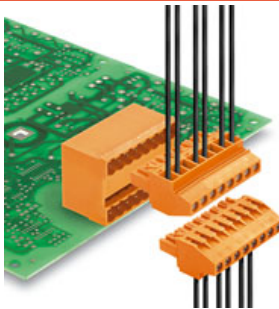

Socket connectors with clamping yoke screw connection for conductor connection with a right-angle (90° or 270°) outlet direction. The female connectors provide space for labelling and can be coded. Can be fastened with flange or release latch. They feature an integrated plus/minus screw, protection against false insertion under clamping yoke. They are delivered with an opened clamping yoke.

- 0.2-2.5 mm² (IEC) / 26-12 AWG (UL)
- 400 V (IEC) / 300 V (UL)
- 15 A (IEC) / 10 A (UL)

General ordering data

Order No.	Part designation	Version	GTIN (EAN)	Qty.	Packaging
1950050000	BLZP 5.08/03/90F SN BK BX	PCB plug-in connector, female plug, 5.08 mm, No. of poles: 3, 90°, Clamping yoke connection, Clamping range, max.: 4 mm ² , Box	4032248627981	72 pc(s).	Box
1949810000	BLZP 5.08/03/90F SN OR BX	PCB plug-in connector, female plug, 5.08 mm, No. of poles: 3, 90°, Clamping yoke connection, Clamping range, max.: 4 mm ² , Box	4032248627738	72 pc(s).	Box

System pitch 5.08 mm (0.200 inch) SL-SMT 5.08/03/90G 3.2SN BK BX

Weidmüller Interface GmbH & Co. KG
 Klingenbergstraße 16
 D-32758 Detmold
 Germany
 Fon: +49 5231 14-0
 Fax: +49 5231 14-2083
 www.weidmueller.com

Counterpart

BLZP 5.00/180F SN



Female connectors with clamping yoke screw connection for conductor connection with straight (180°) outlet direction. The female connectors provide space for labelling and can be coded. Can be fastened with flange or release latch. They feature an integrated plus/minus screw, protection against false insertion under clamping yoke. They are delivered with an opened clamping yoke.

- 0.2-2.5 mm² (IEC) / 26-12 AWG (UL)
- 400 V (IEC) / 300 V (UL)
- 19 A (IEC) / 15 A (UL)

General ordering data

Order No.	Part designation	Version	GTIN (EAN)	Qty.	Packaging
1956020000	BLZP 5.00/03/180F SN BK BX	PCB plug-in connector, female plug, 5.00 mm, No. of poles: 3, 180°, Clamping yoke connection, Clamping range, max.: 4 mm ² , Box	4032248634590	100 pc(s).	Box
1955790000	BLZP 5.00/03/180F SN OR BX	PCB plug-in connector, female plug, 5.00 mm, No. of poles: 3, 180°, Clamping yoke connection, Clamping range, max.: 4 mm ² , Box	4032248634330	100 pc(s).	Box

BLZP 5.00/270LH SN



Socket connectors with clamping yoke screw connection for conductor connection with a right-angle (90° or 270°) outlet direction. The female connectors provide space for labelling and can be coded. Can be fastened with flange or release latch. They feature an integrated plus/minus screw, protection against false insertion under clamping yoke. They are delivered with an opened clamping yoke.

- 0.2-2.5 mm² (IEC) / 26-12 AWG (UL)
- 400 V (IEC) / 300 V (UL)
- 15 A (IEC) / 10 A (UL)

General ordering data

Order No.	Part designation	Version	GTIN (EAN)	Qty.	Packaging
1961660000	BLZP 5.00/03/270LH SN BK BX	PCB plug-in connector, female plug, 5.00 mm, No. of poles: 3, 90°, Clamping yoke connection, Clamping range, max.: 4 mm ² , Box	4032248640935	72 pc(s).	Box
1961430000	BLZP 5.00/03/270LH SN OR BX	PCB plug-in connector, female plug, 5.00 mm, No. of poles: 3, 90°, Clamping yoke connection, Clamping range, max.: 4 mm ² , Box	4032248640706	72 pc(s).	Box

System pitch 5.08 mm (0.200 inch) SL-SMT 5.08/03/90G 3.2SN BK BX

Weidmüller Interface GmbH & Co. KG
 Klingenbergstraße 16
 D-32758 Detmold
 Germany
 Fon: +49 5231 14-0
 Fax: +49 5231 14-2083
 www.weidmueller.com

Counterpart

BLZ 5.08/180F



Female connectors with clamping yoke screw connection for conductor connection with straight outlet direction. The female connectors provide space for labelling and can be coded. Packed in cardboard box.

- 0.20 - 2.5 mm² (IEC) / 26 - 12 AWG (UL)
- 400 V (IEC) / 300 V (UL)
- 19 A (IEC) / 15 A (UL)

General ordering data

Order No.	Part designation	Version	GTIN (EAN)	Qty.	Packaging
1803050000	BLZ 5.08/03/180F SN BK BX	PCB plug-in connector, female plug, 5.08 mm, No. of poles: 3, 180°, Clamping yoke connection, Clamping range, max.: 3.31 mm ² , Box	4032248258154	100 pc(s).	Box
1802840000	BLZ 5.08/03/180F SN OR BX	PCB plug-in connector, female plug, 5.08 mm, No. of poles: 3, 180°, Clamping yoke connection, Clamping range, max.: 3.31 mm ² , Box	4032248257690	100 pc(s).	Box

BLT 5.08F

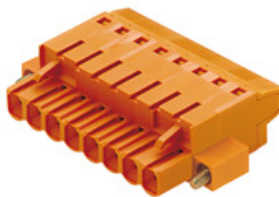

Female connectors with TOP screw system for connecting conductors with straight 180° outlet direction. The female connectors include space for labelling and can be coded. Packed in cardboard box.

- 0.20 - 2.5 mm² (IEC) / 26 - 14 AWG (UL)
- 400 V (IEC) / 300 V (UL)
- 17 A (IEC) / 10 A (UL)

General ordering data

Order No.	Part designation	Version	GTIN (EAN)	Qty.	Packaging
1844230000	BLT 5.08/03/180F SN BK BX	PCB plug-in connector, female plug, 5.08 mm, No. of poles: 3, 180°, TOP connection, Clamping range, max.: 2.5 mm ² , Box	4032248356164	72 pc(s).	Box
1844000000	BLT 5.08/03/180F SN OR BX	PCB plug-in connector, female plug, 5.08 mm, No. of poles: 3, 180°, TOP connection, Clamping range, max.: 2.5 mm ² , Box	4032248355921	72 pc(s).	Box

System pitch 5.08 mm (0.200 inch) SL-SMT 5.08/03/90G 3.2SN BK BX

Weidmüller Interface GmbH & Co. KG
 Klingenbergstraße 16
 D-32758 Detmold
 Germany
 Fon: +49 5231 14-0
 Fax: +49 5231 14-2083
 www.weidmueller.com

Counterpart

BLL 5.08/90FI



Female connector for PCB mounting. The solder pin length is optimised for wave flow soldering. Packed in cardboard box.

- 400 V (IEC) / 300 V (UL)
- 23 A (IEC) / 15 A (UL)

General ordering data

Order No.	Part designation	Version	GTIN (EAN)	Qty.	Packaging
1843760000	BLL 5.08/03/90FI 3.2SN OR BX	PCB plug-in connector, female header, 5.08 mm, No. of poles: 3, 90°, Solder pin length: 3.2 mm, tinned, Orange, Solder connection, Box	4032248355518	100 pc(s).	Box

BLF 5.08/90LH SN



Just as reliable as the tried-and-true original, with innovation in detail:

The BLF 5.0x – the PUSH-IN version of the BLZ 5.0x socket block – features a new connection system and a more compact design. Weidmüller's innovative PUSH-IN spring connection features a trend-setting, tool-free wire connection system that is simple to operate.

In terms of versatility, the BLF 5.0x offers just as much as the older versions:

- The choice of three wire outlet directions offers you proven design flexibility for your applications.
- Four flange variations, including the patented release latch, allow for user-friendly unplugging designs.

General ordering data

Order No.	Part designation	Version	GTIN (EAN)	Qty.	Packaging
1002490000	BLF 5.08/03/90LH SN OR BX	PCB plug-in connector, female plug, 5.08 mm, No. of poles: 3, 90°, PUSH IN, Clamping range, max.: 3.31 mm², Box	4032248694860	72 pc(s).	Box
1000650001	BLF 5.08/03/90LH SN BK BX	PCB plug-in connector, female plug, 5.08 mm, No. of poles: 3, 90°, PUSH IN, Clamping range, max.: 3.31 mm², Box	4032248690848	72 pc(s).	Box

System pitch 5.08 mm (0.200 inch) SL-SMT 5.08/03/90G 3.2SN BK BX

Weidmüller Interface GmbH & Co. KG
 Klingenbergstraße 16
 D-32758 Detmold
 Germany
 Fon: +49 5231 14-0
 Fax: +49 5231 14-2083
 www.weidmueller.com

Counterpart

BLZP 5.00/180LR SN



Female connectors with clamping yoke screw connection for conductor connection with straight (180°) outlet direction. The female connectors provide space for labelling and can be coded. Can be fastened with flange or release latch. They feature an integrated plus/minus screw, protection against false insertion under clamping yoke. They are delivered with an opened clamping yoke.

- 0.2-2.5 mm² (IEC) / 26-12 AWG (UL)
- 400 V (IEC) / 300 V (UL)
- 19 A (IEC) / 15 A (UL)

General ordering data

Order No.	Part designation	Version	GTIN (EAN)	Qty.	Packaging
1956360000	BLZP 5.00/03/180LR SN OR BX	PCB plug-in connector, female plug, 5.00 mm, No. of poles: 3, 180°, Clamping yoke connection, Clamping range, max.: 4 mm ² , Box	4032248635061	100 pc(s).	Box
1956590000	BLZP 5.00/03/180LR SN BK BX	PCB plug-in connector, female plug, 5.00 mm, No. of poles: 3, 180°, Clamping yoke connection, Clamping range, max.: 4 mm ² , Box	4032248635412	100 pc(s).	Box

BLDT 5.08B



Female connectors with two clamping yoke screw connections per pole for conductor connection with 90° & 270° outlet direction. The female connectors provide space for labelling and can be coded. Packed in cardboard box.

- 0.20 - 2.5 mm² (IEC) / 26 - 12 AWG (UL)
- 400 V (IEC) / 300 V (UL)
- 14 A (IEC) / 10 A (UL)

General ordering data

Order No.	Part designation	Version	GTIN (EAN)	Qty.	Packaging
1673790000	BLDT 5.08/03-B SN BK BX	PCB plug-in connector, female plug, 5.08 mm, No. of poles: 3, 90°/270°, Clamping yoke connection, Clamping range, max.: 3.31 mm ² , Box	4008190435516	100 pc(s).	Box
1651750000	BLDT 5.08/03-B SN OR BX	PCB plug-in connector, female plug, 5.08 mm, No. of poles: 3, 90°/270°, Clamping yoke connection, Clamping range, max.: 3.31 mm ² , Box	4008190400439	100 pc(s).	Box

System pitch 5.08 mm (0.200 inch) SL-SMT 5.08/03/90G 3.2SN BK BX

Weidmüller Interface GmbH & Co. KG
 Klingenbergstraße 16
 D-32758 Detmold
 Germany
 Fon: +49 5231 14-0
 Fax: +49 5231 14-2083
 www.weidmueller.com

Counterpart

BLZ 5.00/180F



Female connectors with clamping yoke screw connection for conductor connection with straight outlet direction. The female connectors provide space for labelling and can be coded. Packed in cardboard box.

- 0.20 - 2.5 mm² (IEC) / 26 - 12 AWG (UL)
- 400 V (IEC) / 300 V (UL)
- 19 A (IEC) / 15 A (UL)

General ordering data

Order No.	Part designation	Version	GTIN (EAN)	Qty.	Packaging
1843300000	BLZ 5.00/03/180F SN OR BX	PCB plug-in connector, female plug, 5.00 mm, No. of poles: 3, 180°, Clamping yoke connection, Clamping range, max.: 3.31 mm ² , Box	4032248355020	100 pc(s).	Box
1843530000	BLZ 5.00/03/180F SN BK BX	PCB plug-in connector, female plug, 5.00 mm, No. of poles: 3, 180°, Clamping yoke connection, Clamping range, max.: 3.31 mm ² , Box	4032248355259	100 pc(s).	Box

BLZP 5.08/180LH SN



Female connectors with clamping yoke screw connection for conductor connection with straight (180°) outlet direction. The female connectors provide space for labelling and can be coded. Can be fastened with flange or release latch. They feature an integrated plus/minus screw, protection against false insertion under clamping yoke. They are delivered with an opened clamping yoke.

- 0.2-2.5 mm² (IEC) / 26-12 AWG (UL)
- 400 V (IEC) / 300 V (UL)
- 19 A (IEC) / 15 A (UL)

General ordering data

Order No.	Part designation	Version	GTIN (EAN)	Qty.	Packaging
1945530000	BLZP 5.08/03/180LH SN BK BX	PCB plug-in connector, female plug, 5.08 mm, No. of poles: 3, 180°, Clamping yoke connection, Clamping range, max.: 4 mm ² , Box	4032248620708	100 pc(s).	Box
1945300000	BLZP 5.08/03/180LH SN OR BX	PCB plug-in connector, female plug, 5.08 mm, No. of poles: 3, 180°, Clamping yoke connection, Clamping range, max.: 4 mm ² , Box	4032248619870	100 pc(s).	Box

System pitch 5.08 mm (0.200 inch) SL-SMT 5.08/03/90G 3.2SN BK BX

Weidmüller Interface GmbH & Co. KG
 Klingenbergstraße 16
 D-32758 Detmold
 Germany
 Fon: +49 5231 14-0
 Fax: +49 5231 14-2083
 www.weidmueller.com

Counterpart

BLZ 5.08/90B

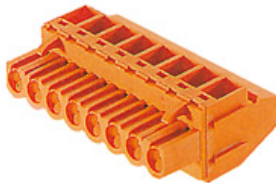

Female connectors with clamping yoke screw connection. The female connectors provide space for labelling and can be coded. Packed in cardboard box.

- 0.20 - 2.5 mm² (IEC) / 26 - 12 AWG (UL)
- 400 V (IEC) / 300 V (UL)
- 15 A (IEC) / 10 A (UL)

General ordering data

Order No.	Part designation	Version	GTIN (EAN)	Qty.	Packaging
1555160000	BLZ 5.08/03/90B SN OR BX	PCB plug-in connector, female plug, 5.08 mm, No. of poles: 3, 90°, Clamping yoke connection, Clamping range, max.: 3.31 mm ² , Box	4008190026059	108 pc(s).	Box
1555110000	BLZ 5.08/03/90B SN BK BX	PCB plug-in connector, female plug, 5.08 mm, No. of poles: 3, 90°, Clamping yoke connection, Clamping range, max.: 3.31 mm ² , Box	4008190267957	108 pc(s).	Box

BLC 5.08BR

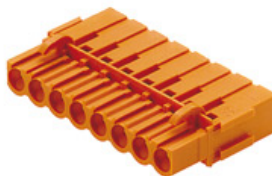

Female connectors for conductor connection with crimp connection system. The female connectors provide space for labelling and can be coded. Packed in cardboard box.

- 0.25 - 2.5 mm² (IEC) / 26 - 14 AWG (UL)
- 400 V (IEC) / 300 V (UL)
- 21 A (IEC) / 10 A (UL)

General ordering data

Order No.	Part designation	Version	GTIN (EAN)	Qty.	Packaging
1712120000	BLC 5.08/03/180BR BK BX	PCB plug-in connector, female plug, 5.08 mm, No. of poles: 3, 180°, Crimp connection, Clamping range, max.: 2.5 mm ² , Box	4008190935139	100 pc(s).	Box
1649380000	BLC 5.08/03/180BR OR BX	PCB plug-in connector, female plug, 5.08 mm, No. of poles: 3, 180°, Crimp connection, Clamping range, max.: 2.5 mm ² , Box	4008190294489	100 pc(s).	Box

System pitch 5.08 mm (0.200 inch) SL-SMT 5.08/03/90G 3.2SN BK BX

Weidmüller Interface GmbH & Co. KG
 Klingenbergstraße 16
 D-32758 Detmold
 Germany
 Fon: +49 5231 14-0
 Fax: +49 5231 14-2083
 www.weidmueller.com

Counterpart

BLL 5.08/180B



Female connector for PCB mounting. The solder pin length is optimised for wave flow soldering. Packed in cardboard box.

- 400 V (IEC) / 300 V (UL)
- 23 A (IEC) / 15 A (UL)

General ordering data

Order No.	Part designation	Version	GTIN (EAN)	Qty.	Packaging
1682740000	BLL 5.08/03/180B 3.2SN OR BX	PCB plug-in connector, female header, 5.08 mm, No. of poles: 3, 180°, Solder pin length: 3.2 mm, tinned, Orange, Solder connection, Box	4008190474508	100 pc(s).	Box

BLF 5.08/90LR SN



Just as reliable as the tried-and-true original, with innovation in detail:

The BLF 5.0x – the PUSH-IN version of the BLZ 5.0x socket block – features a new connection system and a more compact design. Weidmüller's innovative PUSH-IN spring connection features a trend-setting, tool-free wire connection system that is simple to operate.

In terms of versatility, the BLF 5.0x offers just as much as the older versions:

- The choice of three wire outlet directions offers you proven design flexibility for your applications.
- Four flange variations, including the patented release latch, allow for user-friendly unplugging designs.

General ordering data

Order No.	Part designation	Version	GTIN (EAN)	Qty.	Packaging
1000420001	BLF 5.08/03/90LR SN BK BX	PCB plug-in connector, female plug, 5.08 mm, No. of poles: 3, 90°, PUSH IN, Clamping range, max.: 3.31 mm², Box	4032248690381	72 pc(s).	Box
1002290000	BLF 5.08/03/90LR SN OR BX	PCB plug-in connector, female plug, 5.08 mm, No. of poles: 3, 90°, PUSH IN, Clamping range, max.: 3.31 mm², Box	4032248694457	72 pc(s).	Box

System pitch 5.08 mm (0.200 inch) SL-SMT 5.08/03/90G 3.2SN BK BX

Weidmüller Interface GmbH & Co. KG
 Klingenbergstraße 16
 D-32758 Detmold
 Germany
 Fon: +49 5231 14-0
 Fax: +49 5231 14-2083
 www.weidmueller.com

Counterpart

BLZP 5.08/270LR SN



Socket connectors with clamping yoke screw connection for conductor connection with a right-angle (90° or 270°) outlet direction. The female connectors provide space for labelling and can be coded. Can be fastened with flange or release latch. They feature an integrated plus/minus screw, protection against false insertion under clamping yoke. They are delivered with an opened clamping yoke.

- 0.2-2.5 mm² (IEC) / 26-12 AWG (UL)
- 400 V (IEC) / 300 V (UL)
- 15 A (IEC) / 10 A (UL)

General ordering data

Order No.	Part designation	Version	GTIN (EAN)	Qty.	Packaging
1947540000	BLZP 5.08/03/270LR SN OR BX	PCB plug-in connector, female plug, 5.08 mm, No. of poles: 3, 270°, Clamping yoke connection, Clamping range, max.: 4 mm ² , Box	4032248623839	72 pc(s).	Box
1947770000	BLZP 5.08/03/270LR SN BK BX	PCB plug-in connector, female plug, 5.08 mm, No. of poles: 3, 270°, Clamping yoke connection, Clamping range, max.: 4 mm ² , Box	4032248624164	72 pc(s).	Box

BLZ 5.00/270B



Female connectors with clamping yoke screw connection. The female connectors provide space for labelling and can be coded. Packed in cardboard box.

- 0.20 - 2.5 mm² (IEC) / 26 - 12 AWG (UL)
- 400 V (IEC) / 300 V (UL)
- 15 A (IEC) / 10 A (UL)

General ordering data

Order No.	Part designation	Version	GTIN (EAN)	Qty.	Packaging
1638050000	BLZ 5.00/03/270B SN OR BX	PCB plug-in connector, female plug, 5.00 mm, No. of poles: 3, 270°, Clamping yoke connection, Clamping range, max.: 3.31 mm ² , Box	4008190275310	108 pc(s).	Box

**System pitch 5.08 mm (0.200 inch)
SL-SMT 5.08/03/90G 3.2SN BK BX**

Weidmüller Interface GmbH & Co. KG
Klingenbergstraße 16
D-32758 Detmold
Germany
Fon: +49 5231 14-0
Fax: +49 5231 14-2083
www.weidmueller.com

Counterpart
BLZF 5.08/180F

Female connectors for connecting conductors with tension clamp system, straight 180° outlet direction. The female connectors include space for labelling and can be coded. Packed in cardboard box.

- 0.20 - 2.5 mm² (IEC) / 26 - 12 AWG (UL)
- 400 V (IEC) / 300 V (UL)
- 17 A (IEC) / 15 A (UL)

General ordering data

Order No.	Part designation	Version	GTIN (EAN)	Qty.	Packaging
1803340000	BLZF 5.08/03/180F SN OR BX	PCB plug-in connector, female plug, 5.08 mm, No. of poles: 3, 180°, Tension clamp connection, Clamping range, max.: 3.31 mm ² , Box	4032248258741	72 pc(s).	Box
1803570000	BLZF 5.08/03/180F SN BK BX	PCB plug-in connector, female plug, 5.08 mm, No. of poles: 3, 180°, Tension clamp connection, Clamping range, max.: 3.31 mm ² , Box	4032248258970	72 pc(s).	Box

BLZF 5.08/180LH

Socket blocks for conductor connection, featuring the time-saving tension clamp technology, with straight outlet direction and release lever or release latch mechanism. The female connectors provide space for labelling and can be coded. Packed in cardboard box.

- 0.20 - 1.5 mm² (IEC) / 26 - 12 AWG (UL)
- 400 V (IEC) / 300 V (UL)
- 17 A (IEC) / 15 A (UL)

General ordering data

Order No.	Part designation	Version	GTIN (EAN)	Qty.	Packaging
1895730000	BLZF 5.08/03/180LH SN OR BX	PCB plug-in connector, female plug, 5.08 mm, No. of poles: 3, 180°, Tension clamp connection, Clamping range, max.: 3.31 mm ² , Box	4032248510450	72 pc(s).	Box
1893170000	BLZF 5.08/03/180LH SN BK BX	PCB plug-in connector, female plug, 5.08 mm, No. of poles: 3, 180°, Tension clamp connection, Clamping range, max.: 3.31 mm ² , Box	4032248507313	72 pc(s).	Box

System pitch 5.08 mm (0.200 inch) SL-SMT 5.08/03/90G 3.2SN BK BX

Weidmüller Interface GmbH & Co. KG
Klingenbergstraße 16
D-32758 Detmold
Germany
Fon: +49 5231 14-0
Fax: +49 5231 14-2083
www.weidmueller.com

Counterpart

BLF 5.00/90LH SN



Just as reliable as the tried-and-true original, with innovation in detail:

The BLF 5.0x – the PUSH-IN version of the BLZ 5.0x socket block – features a new connection system and a more compact design. Weidmüller's innovative PUSH-IN spring connection features a trend-setting, tool-free wire connection system that is simple to operate.

In terms of versatility, the BLF 5.0x offers just as much as the older versions:

- The choice of three wire outlet directions offers you proven design flexibility for your applications.
- Four flange variations, including the patented release latch, allow for user-friendly unplugging designs.

General ordering data

Order No.	Part designation	Version	GTIN (EAN)	Qty.	Packaging
1979990000	BLF 5.00/03/90LH SN BK BX	PCB plug-in connector, female plug, 5.00 mm, No. of poles: 3, 90°, PUSH IN, Clamping range, max.: 3.31 mm², Box	4032248675050	72 pc(s).	Box
1981380000	BLF 5.00/03/90LH SN OR BX	PCB plug-in connector, female plug, 5.00 mm, No. of poles: 3, 90°, PUSH IN, Clamping range, max.: 3.31 mm², Box	4032248676682	72 pc(s).	Box

BLT 5.08LR



Socket connectors with clamping yoke screw connection for conductor connection with 270° outlet direction and release lever or release latch mechanism. The female connectors provide space for labelling and can be coded. Packed in cardboard box.

- 0.20 - 1.5 mm² (IEC) / 26 - 14 AWG (UL)
- 400 V (IEC) / 300 V (UL)
- 17 A (IEC) / 10 A (UL)

General ordering data

Order No.	Part designation	Version	GTIN (EAN)	Qty.	Packaging
1890230000	BLT 5.08/03/180LR SN OR BX	PCB plug-in connector, female plug, 5.08 mm, No. of poles: 3, 180°, TOP connection, Clamping range, max.: 2.5 mm², Box	4032248498710	72 pc(s).	Box
1894140000	BLT 5.08/03/180LR SN BK BX	PCB plug-in connector, female plug, 5.08 mm, No. of poles: 3, 180°, TOP connection, Clamping range, max.: 2.5 mm², Box	4032248508389	72 pc(s).	Box

System pitch 5.08 mm (0.200 inch) SL-SMT 5.08/03/90G 3.2SN BK BX

Weidmüller Interface GmbH & Co. KG
 Klingenbergstraße 16
 D-32758 Detmold
 Germany
 Fon: +49 5231 14-0
 Fax: +49 5231 14-2083
 www.weidmueller.com

Counterpart

BLZ 5.08/180LR



Socket connectors with clamping yoke screw connection for conductor connection with 270° outlet direction and release lever or release latch mechanism. The female connectors provide space for labelling and can be coded. Packed in cardboard box.

- 0.20 - 1.5 mm² (IEC) / 26 - 12 AWG (UL)
- 400 V (IEC) / 300 V (UL)
- 19 A (IEC) / 15 A (UL)

General ordering data

Order No.	Part designation	Version	GTIN (EAN)	Qty.	Packaging
1892960000	BLZ 5.08/03/180LR SN BK BX	PCB plug-in connector, female plug, 5.08 mm, No. of poles: 3, 180°, Clamping yoke connection, Clamping range, max.: 3.31 mm ² , Box	4032248507108	100 pc(s).	Box
1851210000	BLZ 5.08/03/180LR SN OR BX	PCB plug-in connector, female plug, 5.08 mm, No. of poles: 3, 180°, Clamping yoke connection, Clamping range, max.: 3.31 mm ² , Box	4032248381289	100 pc(s).	Box

BLZP 5.00/270LR SN



Socket connectors with clamping yoke screw connection for conductor connection with a right-angle (90° or 270°) outlet direction. The female connectors provide space for labelling and can be coded. Can be fastened with flange or release latch. They feature an integrated plus/minus screw, protection against false insertion under clamping yoke. They are delivered with an opened clamping yoke.

- 0.2-2.5 mm² (IEC) / 26-12 AWG (UL)
- 400 V (IEC) / 300 V (UL)
- 15 A (IEC) / 10 A (UL)

General ordering data

Order No.	Part designation	Version	GTIN (EAN)	Qty.	Packaging
1961180000	BLZP 5.00/03/270LR SN BK BX	PCB plug-in connector, female plug, 5.00 mm, No. of poles: 3, 90°, Clamping yoke connection, Clamping range, max.: 4 mm ² , Box	4032248640270	72 pc(s).	Box
1960950000	BLZP 5.00/03/270LR SN OR BX	PCB plug-in connector, female plug, 5.00 mm, No. of poles: 3, 90°, Clamping yoke connection, Clamping range, max.: 4 mm ² , Box	4032248639984	72 pc(s).	Box

System pitch 5.08 mm (0.200 inch) SL-SMT 5.08/03/90G 3.2SN BK BX

Weidmüller Interface GmbH & Co. KG
 Klingenbergstraße 16
 D-32758 Detmold
 Germany
 Fon: +49 5231 14-0
 Fax: +49 5231 14-2083
 www.weidmueller.com

Counterpart

BLZF 5.08/90B



Female connectors for connecting conductors with tension clamp system. The female connectors include space for labelling and can be coded. Packed in cardboard box.

- 0.20 - 2.5 mm² (IEC) / 26 - 12 AWG (UL)
- 400 V (IEC) / 300 V (UL)
- 16.5 A (IEC) / 10 A (UL)

General ordering data

Order No.	Part designation	Version	GTIN (EAN)	Qty.	Packaging
1671260000	BLZF 5.08/03/90B SN OR BX	PCB plug-in connector, female plug, 5.08 mm, No. of poles: 3, 90°, Tension clamp connection, Clamping range, max.: 3.31 mm ² , Box	4008190432966	108 pc(s).	Box
1671490000	BLZF 5.08/03/90B SN BK BX	PCB plug-in connector, female plug, 5.08 mm, No. of poles: 3, 90°, Tension clamp connection, Clamping range, max.: 3.31 mm ² , Box	4008190433192	108 pc(s).	Box

BLF 5.00/90F SN



Just as reliable as the tried-and-true original, with innovation in detail:

The BLF 5.0x – the PUSH-IN version of the BLZ 5.0x socket block – features a new connection system and a more compact design. Weidmüller's innovative PUSH-IN spring connection features a trend-setting, tool-free wire connection system that is simple to operate.

In terms of versatility, the BLF 5.0x offers just as much as the older versions:

- The choice of three wire outlet directions offers you proven design flexibility for your applications.
- Four flange variations, including the patented release latch, allow for user-friendly unplugging designs.

General ordering data

Order No.	Part designation	Version	GTIN (EAN)	Qty.	Packaging
1980650000	BLF 5.00/03/90F SN OR BX	PCB plug-in connector, female plug, 5.00 mm, No. of poles: 3, 90°, PUSH IN, Clamping range, max.: 3.31 mm ² , Box	4032248675708	72 pc(s).	Box
1979470000	BLF 5.00/03/90F SN BK BX	PCB plug-in connector, female plug, 5.00 mm, No. of poles: 3, 90°, PUSH IN, Clamping range, max.: 3.31 mm ² , Box	4032248674671	72 pc(s).	Box

System pitch 5.08 mm (0.200 inch) SL-SMT 5.08/03/90G 3.2SN BK BX

Weidmüller Interface GmbH & Co. KG
 Klingenbergstraße 16
 D-32758 Detmold
 Germany
 Fon: +49 5231 14-0
 Fax: +49 5231 14-2083
 www.weidmueller.com

Counterpart

BLF 5.00/90LR SN



Just as reliable as the tried-and-true original, with innovation in detail:

The BLF 5.0x – the PUSH-IN version of the BLZ 5.0x socket block – features a new connection system and a more compact design. Weidmüller's innovative PUSH-IN spring connection features a trend-setting, tool-free wire connection system that is simple to operate.

In terms of versatility, the BLF 5.0x offers just as much as the older versions:

- The choice of three wire outlet directions offers you proven design flexibility for your applications.
- Four flange variations, including the patented release latch, allow for user-friendly unplugging designs.

General ordering data

Order No.	Part designation	Version	GTIN (EAN)	Qty.	Packaging
1979800000	BLF 5.00/03/90LR SN BK BX	PCB plug-in connector, female plug, 5.00 mm, No. of poles: 3, 90°, PUSH IN, Clamping range, max.: 3.31 mm², Box	4032248674060	72 pc(s).	Box
1980880000	BLF 5.00/03/90LR SN OR BX	PCB plug-in connector, female plug, 5.00 mm, No. of poles: 3, 90°, PUSH IN, Clamping range, max.: 3.31 mm², Box	4032248675999	72 pc(s).	Box

BLT 5.08LH



Female connectors with TOP screw system for connecting conductors with straight 180° outlet direction. The female connectors include space for labelling and can be coded. Packed in cardboard box.

- 0.20 - 2.5 mm² (IEC) / 26 - 14 AWG (UL)
- 400 V (IEC) / 300 V (UL)
- 17 A (IEC) / 10 A (UL)

General ordering data

Order No.	Part designation	Version	GTIN (EAN)	Qty.	Packaging
1892500000	BLT 5.08/03/180LH SN BK BX	PCB plug-in connector, female plug, 5.08 mm, No. of poles: 3, 180°, TOP connection, Clamping range, max.: 2.5 mm², Box	4032248506545	72 pc(s).	Box
1889970000	BLT 5.08/03/180LH SN OR BX	PCB plug-in connector, female plug, 5.08 mm, No. of poles: 3, 180°, TOP connection, Clamping range, max.: 2.5 mm², Box	4032248498413	72 pc(s).	Box

System pitch 5.08 mm (0.200 inch) SL-SMT 5.08/03/90G 3.2SN BK BX

Weidmüller Interface GmbH & Co. KG
 Klingenbergstraße 16
 D-32758 Detmold
 Germany
 Fon: +49 5231 14-0
 Fax: +49 5231 14-2083
 www.weidmueller.com

Counterpart

BLZP 5.00/90F SN



Socket connectors with clamping yoke screw connection for conductor connection with a right-angle (90° or 270°) outlet direction. The female connectors provide space for labelling and can be coded. Can be fastened with flange or release latch. They feature an integrated plus/minus screw, protection against false insertion under clamping yoke. They are delivered with an opened clamping yoke.

- 0.2-2.5 mm² (IEC) / 26-12 AWG (UL)
- 400 V (IEC) / 300 V (UL)
- 15 A (IEC) / 10 A (UL)

General ordering data

Order No.	Part designation	Version	GTIN (EAN)	Qty.	Packaging
1959740000	BLZP 5.00/03/90F SN BK BX	PCB plug-in connector, female plug, 5.00 mm, No. of poles: 3, 90°, Clamping yoke connection, Clamping range, max.: 4 mm ² , Box	4032248638673	72 pc(s).	Box
1959510000	BLZP 5.00/03/90F SN OR BX	PCB plug-in connector, female plug, 5.00 mm, No. of poles: 3, 90°, Clamping yoke connection, Clamping range, max.: 4 mm ² , Box	4032248638444	72 pc(s).	Box

BLZ 5.08/225B



Female connectors with clamping yoke screw connection for conductor connection with 225° outlet direction. The female connectors provide space for labelling and can be coded. Packed in cardboard box.

- 0.20 - 2.5 mm² (IEC) / 26 - 12 AWG (UL)
- 400 V (IEC) / 300 V (UL)
- 16.5 A (IEC) / 10 A (UL)

General ordering data

Order No.	Part designation	Version	GTIN (EAN)	Qty.	Packaging
1742340000	BLZ 5.08/03/225B SN BK BX	PCB plug-in connector, female plug, 5.08 mm, No. of poles: 3, 225°, Clamping yoke connection, Clamping range, max.: 3.31 mm ² , Box	4032248049776	108 pc(s).	Box
1742110000	BLZ 5.08/03/225B SN OR BX	PCB plug-in connector, female plug, 5.08 mm, No. of poles: 3, 225°, Clamping yoke connection, Clamping range, max.: 3.31 mm ² , Box	4008190243753	108 pc(s).	Box

**System pitch 5.08 mm (0.200 inch)
SL-SMT 5.08/03/90G 3.2SN BK BX**

Weidmüller Interface GmbH & Co. KG
Klingenbergstraße 16
D-32758 Detmold
Germany
Fon: +49 5231 14-0
Fax: +49 5231 14-2083
www.weidmueller.com

Counterpart
BLZ 5.08/270B

Female connectors with clamping yoke screw connection. The female connectors provide space for labelling and can be coded. Packed in cardboard box.

- 0.20 - 2.5 mm² (IEC) / 26 - 12 AWG (UL)
- 400 V (IEC) / 300 V (UL)
- 15 A (IEC) / 10 A (UL)

General ordering data

Order No.	Part designation	Version	GTIN (EAN)	Qty.	Packaging
1559710000	BLZ 5.08/03/270B SN BK BX	PCB plug-in connector, female plug, 5.08 mm, No. of poles: 3, 270°, Clamping yoke connection, Clamping range, max.: 3.31 mm ² , Box	4008190269661	108 pc(s).	Box
1559760000	BLZ 5.08/03/270B SN OR BX	PCB plug-in connector, female plug, 5.08 mm, No. of poles: 3, 270°, Clamping yoke connection, Clamping range, max.: 3.31 mm ² , Box	4008190083731	108 pc(s).	Box

BLZP 5.00/180LH SN

Female connectors with clamping yoke screw connection for conductor connection with straight (180°) outlet direction. The female connectors provide space for labelling and can be coded. Can be fastened with flange or release latch. They feature an integrated plus/minus screw, protection against false insertion under clamping yoke. They are delivered with an opened clamping yoke.

- 0.2-2.5 mm² (IEC) / 26-12 AWG (UL)
- 400 V (IEC) / 300 V (UL)
- 19 A (IEC) / 15 A (UL)

General ordering data

Order No.	Part designation	Version	GTIN (EAN)	Qty.	Packaging
1957280000	BLZP 5.00/03/180LH SN BK BX	PCB plug-in connector, female plug, 5.00 mm, No. of poles: 3, 180°, Clamping yoke connection, Clamping range, max.: 4 mm ² , Box	4032248636099	100 pc(s).	Box
1956980000	BLZP 5.00/03/180LH SN OR BX	PCB plug-in connector, female plug, 5.00 mm, No. of poles: 3, 180°, Clamping yoke connection, Clamping range, max.: 4 mm ² , Box	4032248635863	100 pc(s).	Box

System pitch 5.08 mm (0.200 inch) SL-SMT 5.08/03/90G 3.2SN BK BX

Weidmüller Interface GmbH & Co. KG
 Klingenbergstraße 16
 D-32758 Detmold
 Germany
 Fon: +49 5231 14-0
 Fax: +49 5231 14-2083
 www.weidmueller.com

Counterpart

BLZP 5.08/270LH SN



Socket connectors with clamping yoke screw connection for conductor connection with a right-angle (90° or 270°) outlet direction. The female connectors provide space for labelling and can be coded. Can be fastened with flange or release latch. They feature an integrated plus/minus screw, protection against false insertion under clamping yoke. They are delivered with an opened clamping yoke.

- 0.2-2.5 mm² (IEC) / 26-12 AWG (UL)
- 400 V (IEC) / 300 V (UL)
- 15 A (IEC) / 10 A (UL)

General ordering data

Order No.	Part designation	Version	GTIN (EAN)	Qty.	Packaging
1947020000	BLZP 5.08/03/270LH SN OR BX	PCB plug-in connector, female plug, 5.08 mm, No. of poles: 3, 270°, Clamping yoke connection, Clamping range, max.: 4 mm ² , Box	4032248622788	72 pc(s).	Box
1947250000	BLZP 5.08/03/270LH SN BK BX	PCB plug-in connector, female plug, 5.08 mm, No. of poles: 3, 270°, Clamping yoke connection, Clamping range, max.: 4 mm ² , Box	4032248623143	72 pc(s).	Box

BLZF 5.08/270B



Female connectors for connecting conductors with tension clamp system. The female connectors include space for labelling and can be coded. Packed in cardboard box.

- 0.20 - 2.5 mm² (IEC) / 26 - 12 AWG (UL)
- 400 V (IEC) / 300 V (UL)
- 16.5 A (IEC) / 10 A (UL)

General ordering data

Order No.	Part designation	Version	GTIN (EAN)	Qty.	Packaging
1672410000	BLZF 5.08/03/270B SN OR BX	PCB plug-in connector, female plug, 5.08 mm, No. of poles: 3, 270°, Tension clamp connection, Clamping range, max.: 3.31 mm ² , Box	4008190434120	108 pc(s).	Box
1672640000	BLZF 5.08/03/270B SN BK BX	PCB plug-in connector, female plug, 5.08 mm, No. of poles: 3, 270°, Tension clamp connection, Clamping range, max.: 3.31 mm ² , Box	4008190434359	108 pc(s).	Box

System pitch 5.08 mm (0.200 inch) SL-SMT 5.08/03/90G 3.2SN BK BX

Weidmüller Interface GmbH & Co. KG
 Klingenbergstraße 16
 D-32758 Detmold
 Germany
 Fon: +49 5231 14-0
 Fax: +49 5231 14-2083
 www.weidmueller.com

Counterpart

BLZP 5.08/225B SN



Clamping-yoke wire connection with right-angled (90° or 270°) or angled (225°) outlet direction. The female connectors provide space for labelling and can be coded. Can be fastened with flange or release latch. They feature an integrated plus/minus screw, protection against false insertion under clamping yoke. They are delivered with an opened clamping yoke.

- 0.2-2.5 mm² (IEC) / 26-12 AWG (UL)
- 400 V (IEC) / 300 V (UL)
- 17.5 A (IEC) / 10 A (UL)

General ordering data

Order No.	Part designation	Version	GTIN (EAN)	Qty.	Packaging
1945990000	BLZP 5.08/03/225B SN BK BX	PCB plug-in connector, female plug, 5.08 mm, No. of poles: 3, 225°, Clamping yoke connection, Clamping range, max.: 4 mm ² , Box	4032248621514	108 pc(s).	Box
1945760000	BLZP 5.08/03/225B SN OR BX	PCB plug-in connector, female plug, 5.08 mm, No. of poles: 3, 225°, Clamping yoke connection, Clamping range, max.: 4 mm ² , Box	4032248621231	108 pc(s).	Box

BLF 5.08/90F SN



Just as reliable as the tried-and-true original, with innovation in detail:

The BLF 5.0x – the PUSH-IN version of the BLZ 5.0x socket block – features a new connection system and a more compact design. Weidmüller's innovative PUSH-IN spring connection features a trend-setting, tool-free wire connection system that is simple to operate.

In terms of versatility, the BLF 5.0x offers just as much as the older versions:

- The choice of three wire outlet directions offers you proven design flexibility for your applications.
- Four flange variations, including the patented release latch, allow for user-friendly unplugging designs.

General ordering data

Order No.	Part designation	Version	GTIN (EAN)	Qty.	Packaging
1002100000	BLF 5.08/03/90F SN OR BX	PCB plug-in connector, female plug, 5.08 mm, No. of poles: 3, 90°, PUSH IN, Clamping range, max.: 3.31 mm ² , Box	4032248694051	72 pc(s).	Box
1000230001	BLF 5.08/03/90F SN BK BX	PCB plug-in connector, female plug, 5.08 mm, No. of poles: 3, 90°, PUSH IN, Clamping range, max.: 3.31 mm ² , Box	4032248690190	72 pc(s).	Box

System pitch 5.08 mm (0.200 inch) SL-SMT 5.08/03/90G 3.2SN BK BX

Weidmüller Interface GmbH & Co. KG
Klingenbergstraße 16
D-32758 Detmold
Germany
Fon: +49 5231 14-0
Fax: +49 5231 14-2083
www.weidmueller.com

Counterpart

BLZP 5.08/180LR SN



Female connectors with clamping yoke screw connection for conductor connection with straight (180°) outlet direction. The female connectors provide space for labelling and can be coded. Can be fastened with flange or release latch. They feature an integrated plus/minus screw, protection against false insertion under clamping yoke. They are delivered with an opened clamping yoke.

- 0.2-2.5 mm² (IEC) / 26-12 AWG (UL)
- 400 V (IEC) / 300 V (UL)
- 19 A (IEC) / 15 A (UL)

General ordering data

Order No.	Part designation	Version	GTIN (EAN)	Qty.	Packaging
1945070000	BLZP 5.08/03/180LR SN BK BX	PCB plug-in connector, female plug, 5.08 mm, No. of poles: 3, 180°, Clamping yoke connection, Clamping range, max.: 4 mm ² , Box	4032248620210	100 pc(s).	Box
1944840000	BLZP 5.08/03/180LR SN OR BX	PCB plug-in connector, female plug, 5.08 mm, No. of poles: 3, 180°, Clamping yoke connection, Clamping range, max.: 4 mm ² , Box	4032248619443	100 pc(s).	Box

BLZF 5.08/180LR



Female connectors for connecting conductors with tension clamp system, straight 180° outlet direction. The female connectors include space for labelling and can be coded. Packed in cardboard box.

- 0.20 - 2.5 mm² (IEC) / 26 - 12 AWG (UL)
- 400 V (IEC) / 300 V (UL)
- 17 A (IEC) / 15 A (UL)

General ordering data

Order No.	Part designation	Version	GTIN (EAN)	Qty.	Packaging
1851420000	BLZF 5.08/03/180LR SN OR BX	PCB plug-in connector, female plug, 5.08 mm, No. of poles: 3, 180°, Tension clamp connection, Clamping range, max.: 3.31 mm ² , Box	4032248382798	72 pc(s).	Box
1892730000	BLZF 5.08/03/180LR SN BK BX	PCB plug-in connector, female plug, 5.08 mm, No. of poles: 3, 180°, Tension clamp connection, Clamping range, max.: 3.31 mm ² , Box	4032248506774	72 pc(s).	Box