

Sensor/actuator box - SACB-4/ 4-L-10,0PUR SCO P NPN - 1405687

Please be informed that the data shown in this PDF Document is generated from our Online Catalog. Please find the complete data in the user's documentation. Our General Terms of Use for Downloads are valid (<http://download.phoenixcontact.com>)



Sensor/actuator box, Connection method: M12-SPEEDCON-socket Plastic, Number of slots: 4, Number of positions: 4, Slot assignment: Single, Status indication: Yes, npn; Master cable connection: Fixed connection 180°, PUR/PVC, Cable length: 10 m, Shielding: No

Product Features

- ✓ Safety in the field, thanks to molded housing and high degree of protection
- ✓ Flexible, distributed bundling of signals in one master cable
- ✓ Convenient: increased machine availability thanks to quick and easy diagnostics
- ✓ Save time, thanks to installation with SPEEDCON rapid interlock system



Key commercial data

Packing unit	1 PCE
Minimum order quantity	25 PCE
GTIN	 4 046356 782845
Custom tariff number	85444290
Country of origin	POLAND

Technical data

General

Rated voltage	24 V DC
Max. operating voltage U_{max}	30 V DC
Current carrying capacity per I/O signal	2 A
Current carrying capacity per slot	4 A
Total rated current	12 A
Number of positions	4
Number of slots	4

Sensor/actuator box - SACB-4/ 4-L-10,0PUR SCO P NPN - 1405687

Technical data

General

Sensor/actuator connection system	M12-SPEEDCON-socket
-----------------------------------	---------------------

Ambient conditions

Degree of protection	IP65
	IP67
Ambient temperature (operation)	-25 °C ... 80 °C
	-40 °C ... 90 °C (for fixed installation)
	-5 °C ... 80 °C (for flexible installation)

Local diagnostics function

Local diagnostics	Supply voltage Green LED
	Status display I/O Yellow LED

Master cable connection data

Connection method	Fixed connection
Length of cable	10 m
Tightening torque slot sensor/actuator cable	0.4 Nm
Tightening torque screw plug	0.4 Nm

Insulation material

Housing material	PBT
Material of the moulding mass	PUR
Contact material	Cu alloy
Contact surface material	Gold-plated
Contact carrier material	PA
Material of threaded sleeve	PBT
Material, O-ring	NBR

Pin assignment

Slot/position = Wire color or connection	1 / 4 (A) = WH
	2 / 4 (A) = GN
	3 / 4 (A) = YE
	4 / 4 (A) = GY
	1-4 / 1 (+ 24 V) = BN
	1-4 / 3 (0 V) = BU
	1-4 / 5 (PE) = GN/YE

Cable

Cable type	PUR/PVC black
Cable type (abbreviation)	PUR
Cable abbreviation	LiYY11Y-HF

Sensor/actuator box - SACB-4/ 4-L-10,0PUR SCO P NPN - 1405687

Technical data

Cable

UL AWM style	20549
Conductor cross section	4x 0.34 mm ² (signal line)
	3x 0.75 mm ² (power line)
AWG signal line	22
AWG power supply	18
Conductor structure signal line	19x 0.15 mm
Conductor structure, voltage supply	42x 0.15 mm
Core diameter including insulation	1.3 mm ±0.1 mm (signal line)
	1.8 mm ±0.1 mm (power line)
Thickness, insulation	≥ 0.15 mm (Inner sheath)
	≥ 0.38 mm (Outer cable sheath)
Overall twist	Wires twisted in layers
External sheath, color	Black RAL 9005
External cable diameter D	6.9 mm ± 0.2 mm
Minimum bending radius, fixed installation	7.5 x D
Minimum bending radius, flexible installation	10 x D
Number of bending cycles	1500000
Bending radius	69 mm
Traversing path	2 m
Traversing rate	2 m/s
Cable weight	77.9 kg/km
Outer sheath, material	PUR
Material, inner sheath	PVC
Material conductor insulation	PVC
Conductor material	Bare Cu litz wires
Nominal voltage, cable	300 V
Test voltage, cable	2000 V
Special properties	Silicone-free
Flame resistance	DIN EN 50265
Resistance to oil	As per VDE 0472 Part 803
Other resistance	Highly resistant to acids, alkaline solutions and solvents
Ambient temperature (operation)	-40 °C ... 90 °C (cable, fixed installation)
	-5 °C ... 80 °C (cable, flexible installation)

Sensor/actuator box - SACB-4/ 4-L-10,0PUR SCO P NPN - 1405687

Classifications

eCl@ss

eCl@ss 4.0	27140815
eCl@ss 4.1	27140815
eCl@ss 5.0	27143423
eCl@ss 5.1	27143423
eCl@ss 6.0	27279219
eCl@ss 7.0	27279219
eCl@ss 8.0	27279219

ETIM

ETIM 3.0	EC001856
ETIM 4.0	EC002585
ETIM 5.0	EC002585

UNSPSC

UNSPSC 6.01	31261501
UNSPSC 7.0901	31261501
UNSPSC 11	31261501
UNSPSC 12.01	31261501
UNSPSC 13.2	31261501

Approvals

Approvals

Approvals

UL Recognized / cUL Recognized / GOST / cULus Recognized

Ex Approvals

Approvals submitted

Approval details

Sensor/actuator box - SACB-4/ 4-L-10,0PUR SCO P NPN - 1405687

Approvals

UL Recognized	
Nominal voltage UN	24 V

cUL Recognized	
Nominal voltage UN	24 V

GOST	
------	--

cULus Recognized	
------------------	--

Accessories

Accessories

Marking

Contact marker – zack marker strip - SS-ZB 17,5 WH - 0804963



Contact marker – zack marker strip, Strip, white, Unlabeled, Can be labeled with: Plotter, Mounting type: Snap into flat marker groove, Lettering field: 17.5 x 8 mm

Contact marker – zack marker strip - SS-ZB 17,5 YE - 0804976



Contact marker – zack marker strip, Strip, yellow, Unlabeled, Can be labeled with: Plotter, Mounting type: Snap into flat marker groove, Lettering field: 17.5 x 8 mm

Sensor/actuator box - SACB-4/ 4-L-10,0PUR SCO P NPN - 1405687

Accessories

Contact marker – zack marker strip - SS-ZB 17,5 WH CUS - 0824468



Contact marker – zack marker strip, Can be ordered: Strip, white, Labeled according to customer specifications, Mounting type: Snap into flat marker groove, Lettering field: 17.5 x 8 mm

Contact marker – zack marker strip - SS-ZB 17,5 YE CUS - 0824469



Contact marker – zack marker strip, Can be ordered: Strip, yellow, Labeled according to customer specifications, Mounting type: Snap into flat marker groove, Lettering field: 17.5 x 8 mm

Protection and sealing elements

Screw plug - PROT-MS SCO - 1553129



M12 screw plug with SPEEDCON quick locking for unoccupied M12 sockets of the sensor/actuator cables, boxes and flush-type connectors

Tools

Torque screwdriver - TSD 04 SAC - 1208429



Torque screwdriver, with preset torque of 0.4 Nm and 4 mm hexagonal drive for M12 connectors

Tool - SAC BIT M12-D15 - 1208432



Nut for assembling sensor/actuator cables with M12 connector and for M12 connectors with QUICKON fast connection technology, for 4 mm hexagonal drive

Sensor/actuator box - SACB-4/ 4-L-10,0PUR SCO P NPN - 1405687

Accessories

Tool - SACC BIT M12-D20 - 1208445



Nut for assembling SACC M12 connectors for free assembly, excluding M12 connectors with QUICKON fast connection technology, for 4 mm hexagonal drive

Drawings

Schematic diagram

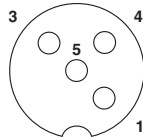

M12 slot, socket, 4-pos.

Cable cross section

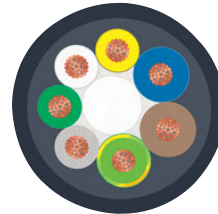

PUR/PVC black [PUR]

Dimensioned drawing

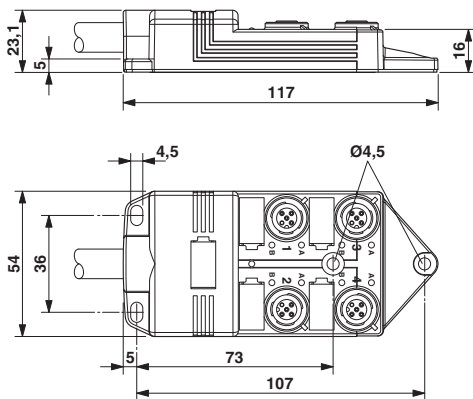

Circuit diagram

