

# NJL21193DG (PNP), NJL21194DG (NPN)

## Complementary ThermalTrak™ Transistors

The ThermalTrak family of devices has been designed to eliminate thermal equilibrium lag time and bias trimming in audio amplifier applications. They can also be used in other applications as transistor die protection devices.

### Features

- Thermally Matched Bias Diode
- Instant Thermal Bias Tracking
- Absolute Thermal Integrity
- Medium Frequency Device with Extended Safe Operating Area
- These are Pb-Free Devices

### Benefits

- Eliminates Thermal Equilibrium Lag Time and Bias Trimming
- Superior Sound Quality Through Improved Dynamic Temperature Response
- Significantly Improved Bias Stability
- Simplified Assembly
  - ◆ Reduced Labor Costs
  - ◆ Reduced Component Count
- High Reliability

### Applications

- High-End Consumer Audio Products
  - ◆ Home Amplifiers
  - ◆ Home Receivers
- Professional Audio Amplifiers
  - ◆ Theater and Stadium Sound Systems
  - ◆ Public Address Systems (PAs)



**ON Semiconductor®**

<http://onsemi.com>

**BIPOLAR POWER  
TRANSISTORS  
16 A, 250 V, 200 W**

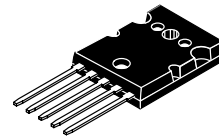

**TO-264, 5 LEAD  
CASE 340AA  
STYLE 1**

### MARKING DIAGRAM

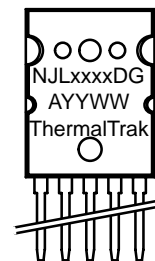

### SCHEMATIC

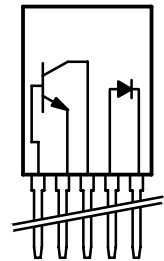

xxxx = Specific Device Code  
G = Pb-Free Device  
A = Assembly Location  
YY = Year  
WW = Work Week

### ORDERING INFORMATION

See detailed ordering and shipping information in the package dimensions section on page 2 of this data sheet.

\*For additional information on our Pb-Free strategy and soldering details, please download the ON Semiconductor Soldering and Mounting Techniques Reference Manual, SOLDERRM/D.

## NJL21193DG (PNP), NJL21194DG (NPN)

### MAXIMUM RATINGS (T<sub>J</sub> = 25°C unless otherwise noted)

Rating	Symbol	Value	Unit
Collector–Emitter Voltage	V <sub>CEO</sub>	250	Vdc
Collector–Base Voltage	V <sub>CBO</sub>	400	Vdc
Emitter–Base Voltage	V <sub>EBO</sub>	5	Vdc
Collector–Emitter Voltage – 1.5 V	V <sub>CEx</sub>	400	Vdc
Collector Current – Continuous – Peak (Note 1)	I <sub>C</sub>	16 30	Adc
Base Current – Continuous	I <sub>B</sub>	5.0	Adc
Total Power Dissipation @ T <sub>C</sub> = 25°C Derate Above 25°C	P <sub>D</sub>	200 1.43	W W/°C
Operating and Storage Junction Temperature Range	T <sub>J</sub> , T <sub>stg</sub>	– 65 to +150	°C
DC Blocking Voltage	V <sub>R</sub>	200	V
Average Rectified Forward Current	I <sub>F(AV)</sub>	1.0	A

### THERMAL CHARACTERISTICS

Characteristic	Symbol	Max	Unit
Thermal Resistance, Junction–to–Case	R <sub>θJC</sub>	0.625	°C/W

Maximum ratings are those values beyond which device damage can occur. Maximum ratings applied to the device are individual stress limit values (not normal operating conditions) and are not valid simultaneously. If these limits are exceeded, device functional operation is not implied, damage may occur and reliability may be affected.

1. Pulse Test: Pulse Width = 5 ms, Duty Cycle < 10%.

### ATTRIBUTES

Characteristic	Value
ESD Protection Human Body Model Machine Model	>8000 V > 400 V
Flammability Rating	UL 94 V–0 @ 0.125 in

### ORDERING INFORMATION

Device	Package	Shipping
NJL21193DG	TO–264 (Pb–Free)	25 Units / Rail
NJL21194DG	TO–264 (Pb–Free)	25 Units / Rail

# NJL21193DG (PNP), NJL21194DG (NPN)

## ELECTRICAL CHARACTERISTICS (T<sub>C</sub> = 25°C unless otherwise noted)

Characteristic	Symbol	Min	Max	Unit
----------------	--------	-----	-----	------

### OFF CHARACTERISTICS

Collector–Emitter Sustaining Voltage (I <sub>C</sub> = 100 mAdc, I <sub>B</sub> = 0)	V <sub>CEO(sus)</sub>	250	–	Vdc
Collector Cutoff Current (V <sub>CE</sub> = 200 Vdc, I <sub>B</sub> = 0)	I <sub>CEO</sub>	–	100	μAdc
Emitter Cutoff Current (V <sub>CE</sub> = 5 Vdc, I <sub>C</sub> = 0)	I <sub>EBO</sub>	–	100	μAdc
Collector Cutoff Current (V <sub>CE</sub> = 250 Vdc, V <sub>BE(off)</sub> = 1.5 Vdc)	I <sub>CEX</sub>	–	100	μAdc

### SECOND BREAKDOWN

Second Breakdown Collector Current with Base Forward Biased (V <sub>CE</sub> = 50 Vdc, t = 1 s (non-repetitive)) (V <sub>CE</sub> = 80 Vdc, t = 1 s (non-repetitive))	I <sub>S/b</sub>	4.0 2.25	– –	Adc
---	------------------	-------------	--------	-----

### ON CHARACTERISTICS

DC Current Gain (I <sub>C</sub> = 8 Adc, V <sub>CE</sub> = 5 Vdc) (I <sub>C</sub> = 16 Adc, I <sub>B</sub> = 5 Adc)	h <sub>FE</sub>	25 8	75 –	
Base–Emitter On Voltage (I <sub>C</sub> = 8 Adc, V <sub>CE</sub> = 5 Vdc)	V <sub>BE(on)</sub>	–	2.2	Vdc
Collector–Emitter Saturation Voltage (I <sub>C</sub> = 8 Adc, I <sub>B</sub> = 0.8 Adc) (I <sub>C</sub> = 16 Adc, I <sub>B</sub> = 3.2 Adc)	V <sub>CE(sat)</sub>	– –	1.4 4	Vdc

### DYNAMIC CHARACTERISTICS

Total Harmonic Distortion at the Output V <sub>RMS</sub> = 28.3 V, f = 1 kHz, P <sub>LOAD</sub> = 100 W <sub>RMS</sub> (Matched pair h <sub>FE</sub> = 50 @ 5 A/5 V)	T <sub>HD</sub>	h <sub>FE</sub> unmatched h <sub>FE</sub> matched	– – –	%
Current Gain Bandwidth Product (I <sub>C</sub> = 1 Adc, V <sub>CE</sub> = 10 Vdc, f <sub>test</sub> = 1 MHz)	f <sub>T</sub>	4	–	MHz
Output Capacitance (V <sub>CB</sub> = 10 Vdc, I <sub>E</sub> = 0, f <sub>test</sub> = 1 MHz)	C <sub>ob</sub>	–	500	pF
Maximum Instantaneous Forward Voltage (Note 2) (i <sub>F</sub> = 1.0 A, T <sub>J</sub> = 25°C) (i <sub>F</sub> = 1.0 A, T <sub>J</sub> = 150°C)	V <sub>F</sub>		1.1 0.93	V
Maximum Instantaneous Reverse Current (Note 2) (Rated dc Voltage, T <sub>J</sub> = 25°C) (Rated dc Voltage, T <sub>J</sub> = 150°C)	i <sub>R</sub>		10 100	μA
Maximum Reverse Recovery Time (i <sub>F</sub> = 1.0 A, di/dt = 50 A/μs)	t <sub>rr</sub>		100	ns

2. Diode Pulse Test: Pulse Width = 300 μs, Duty Cycle ≤ 2.0%.

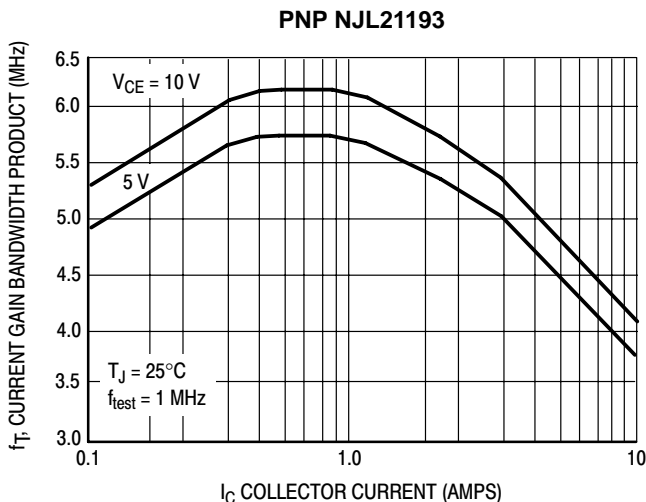

Figure 1. Typical Current Gain Bandwidth Product

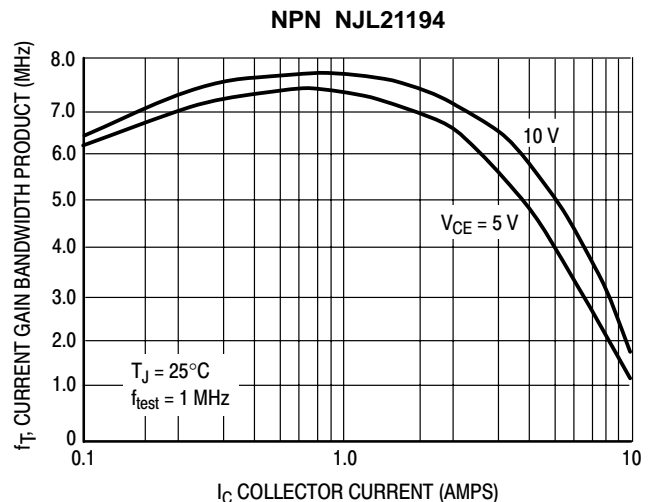

Figure 2. Typical Current Gain Bandwidth Product

# NJL21193DG (PNP), NJL21194DG (NPN)

## TYPICAL CHARACTERISTICS

PNP NJL21193

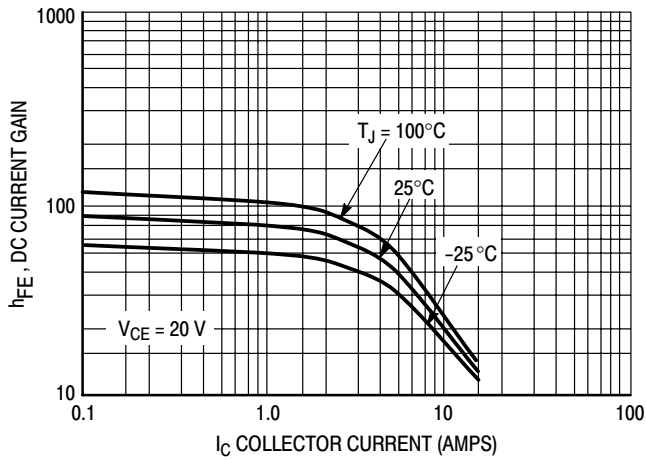

Figure 3. DC Current Gain,  $V_{CE} = 20\text{ V}$

NPN NJL21194

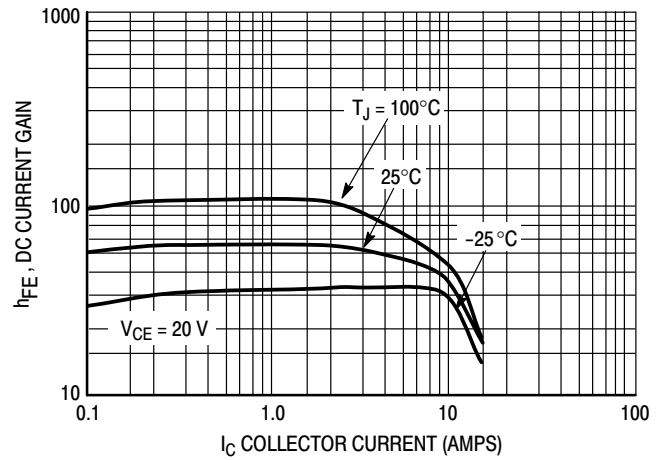

Figure 4. DC Current Gain,  $V_{CE} = 20\text{ V}$

PNP NJL21193

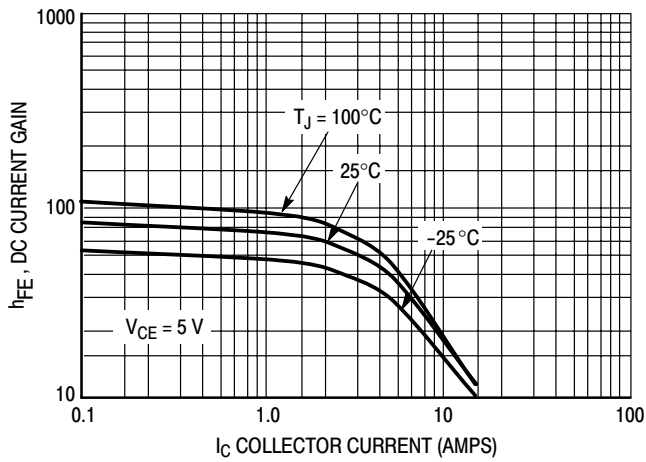

Figure 5. DC Current Gain,  $V_{CE} = 5\text{ V}$

NPN NJL21194

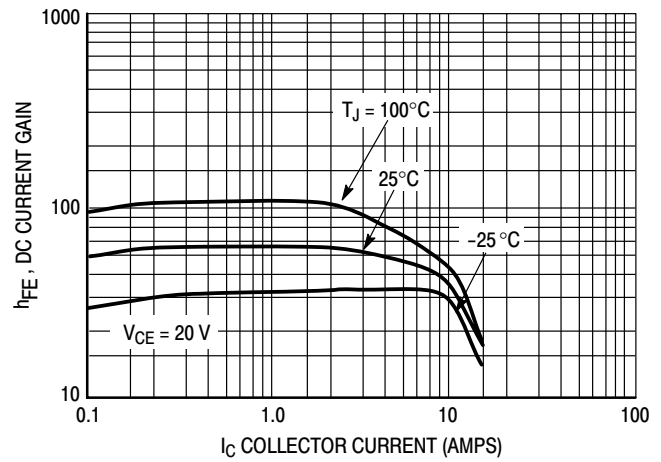
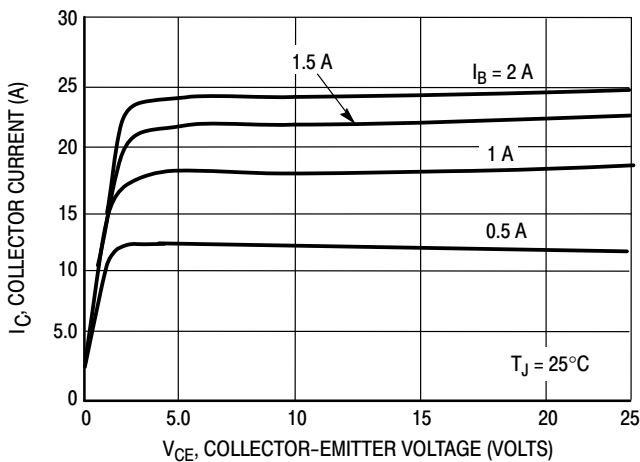
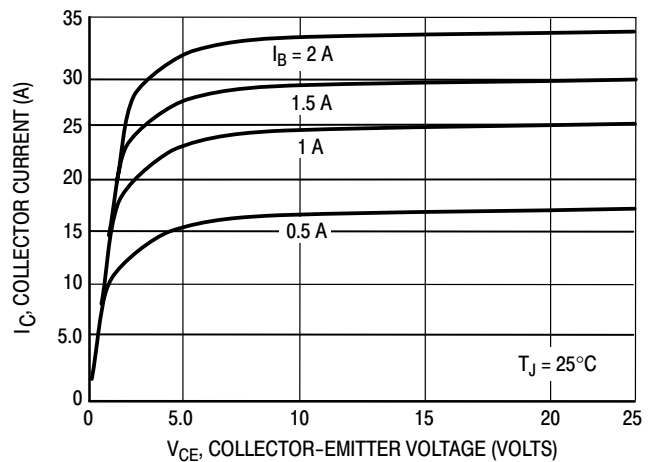

Figure 6. DC Current Gain,  $V_{CE} = 5\text{ V}$

PNP NJL21193



NPN NJL21194



# NJL21193DG (PNP), NJL21194DG (NPN)

## TYPICAL CHARACTERISTICS

PNP NJL21193

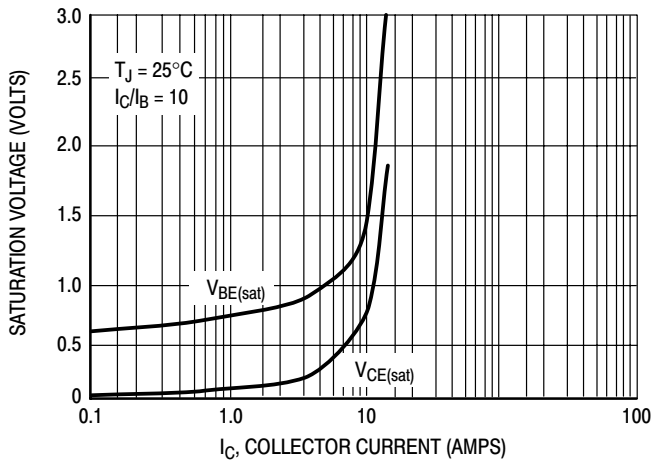

Figure 9. Typical Saturation Voltages

NPN NJL21194

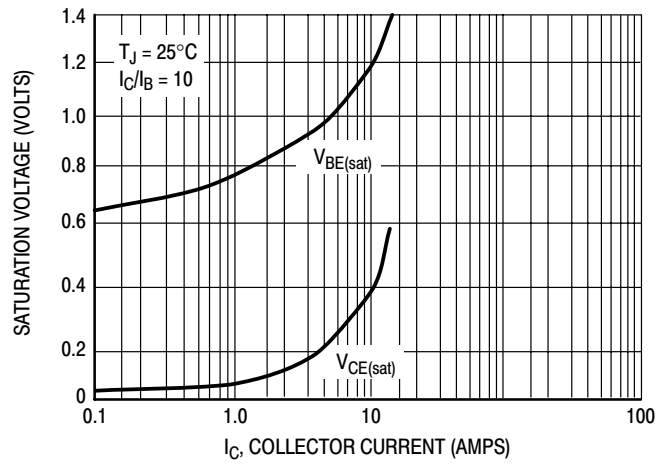

Figure 10. Typical Saturation Voltages

PNP NJL21193

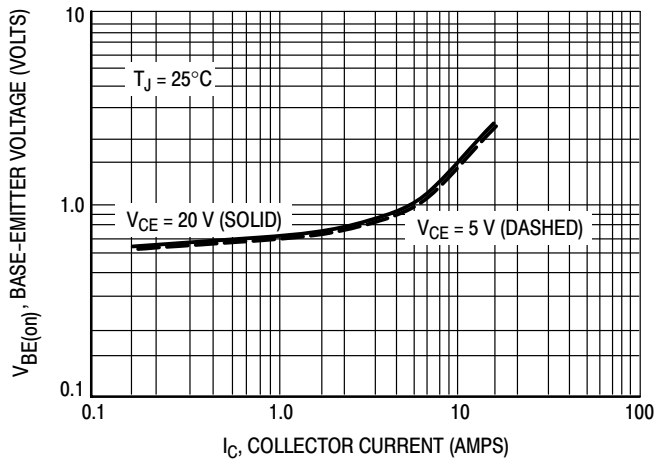

Figure 11. Typical Base-Emitter Voltage

NPN NJL21194

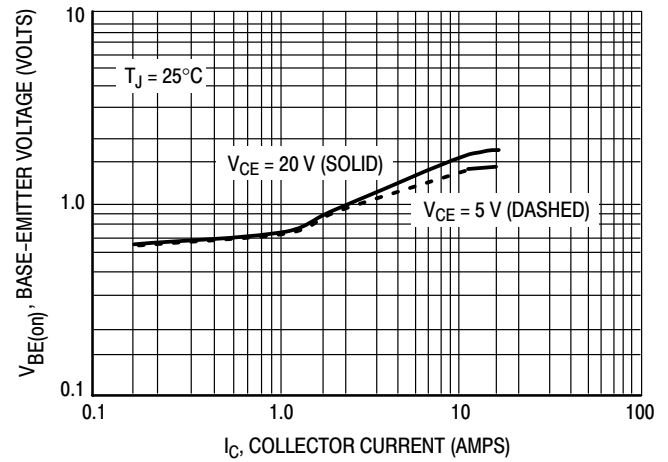
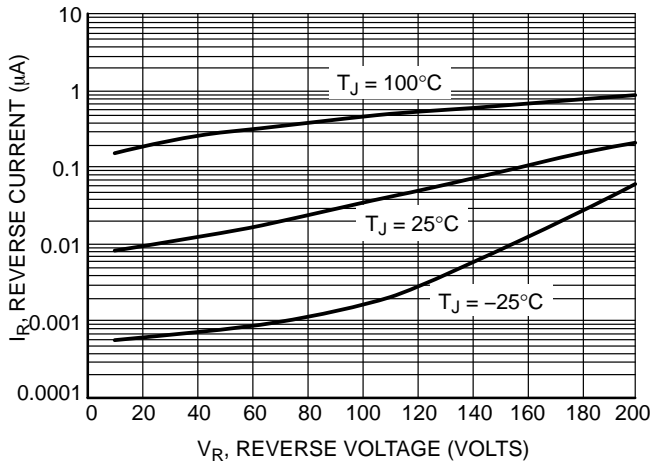
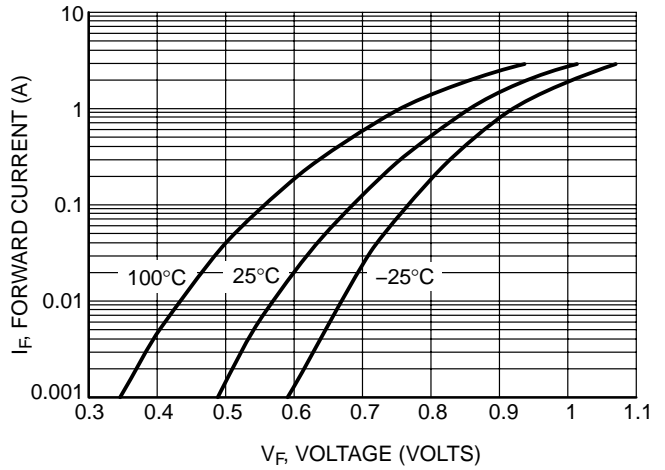

Figure 12. Typical Base-Emitter Voltage

## NJL21193DG (PNP), NJL21194DG (NPN)



**Figure 13. Typical Reverse Current**



**Figure 14. Typical Forward Voltage**

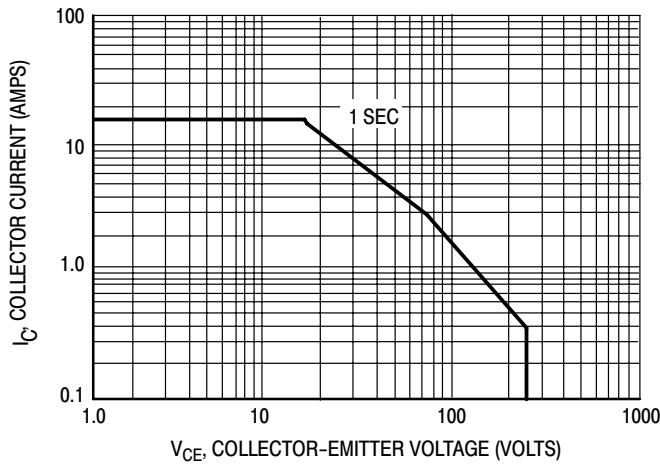

**Figure 15. Active Region Safe Operating Area**

There are two limitations on the power handling ability of a transistor; average junction temperature and secondary breakdown. Safe operating area curves indicate  $I_C - V_{CE}$  limits of the transistor that must be observed for reliable operation; i.e., the transistor must not be subjected to greater dissipation than the curves indicate.

The data of Figure 15 is based on  $T_{J(pk)} = 150^\circ\text{C}$ ;  $T_C$  is variable depending on conditions. At high case temperatures, thermal limitations will reduce the power than can be handled to values less than the limitations imposed by second breakdown.

## NJL21193DG (PNP), NJL21194DG (NPN)

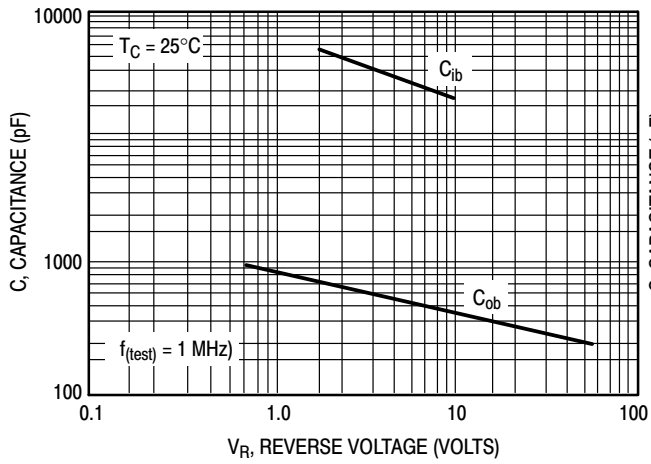

Figure 16. NJL21193 Typical Capacitance

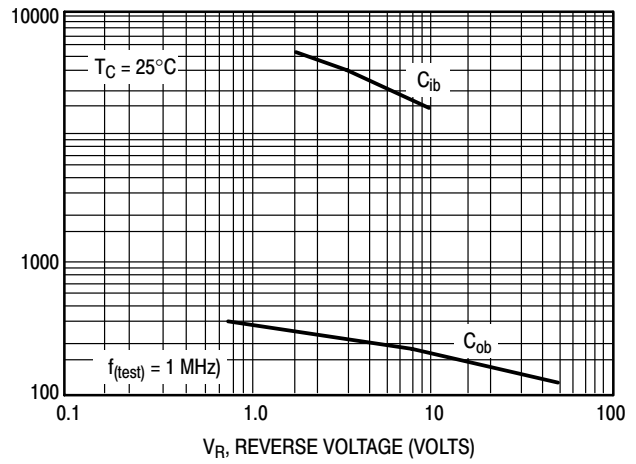

Figure 17. NJL21194 Typical Capacitance

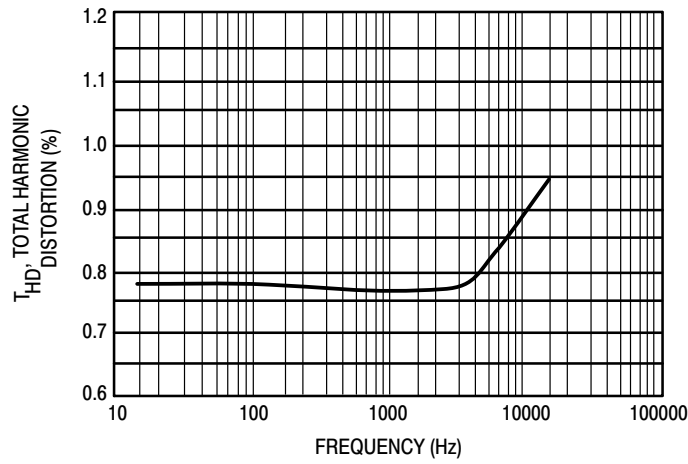

Figure 18. Typical Total Harmonic Distortion

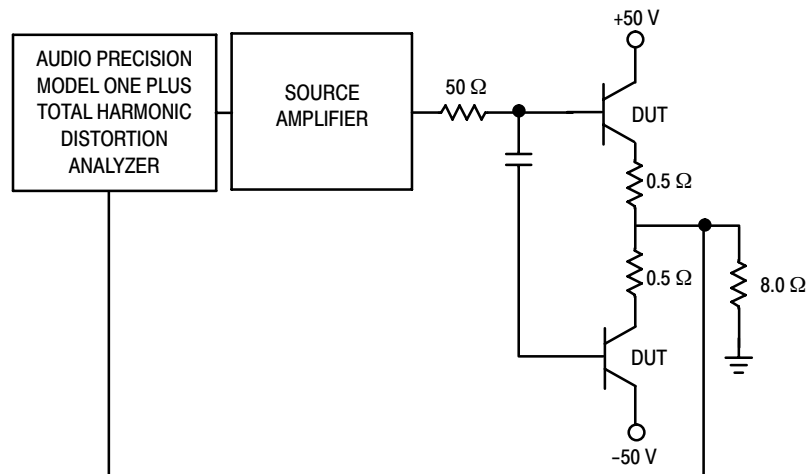
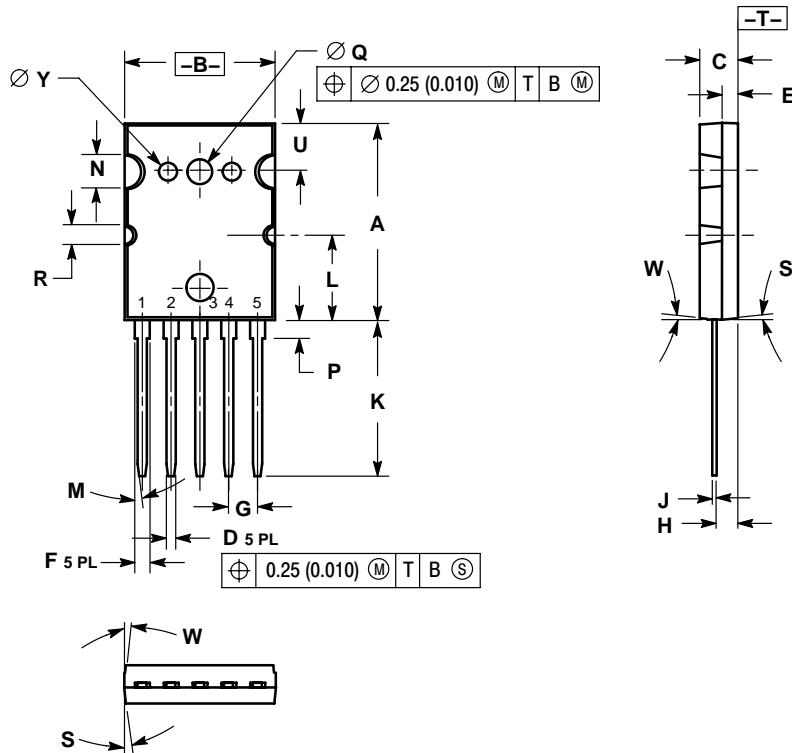

Figure 19. Total Harmonic Distortion Test Circuit

# NJL21193DG (PNP), NJL21194DG (NPN)

## PACKAGE DIMENSIONS

TO-264, 5 LEAD  
CASE 340AA-01  
ISSUE O



- NOTES:  
1. DIMENSIONING AND TOLERANCING PER ANSI Y14.5M, 1982.  
2. CONTROLLING DIMENSION: MILLIMETER.

DIM	MILLIMETERS			INCHES		
	MIN	NOM	MAX	MIN	NOM	MAX
A	25.857	25.984	26.111	1.018	1.023	1.028
B	19.761	19.888	20.015	0.778	0.783	0.788
C	4.928	5.055	5.182	0.194	0.199	0.204
D	1.219 BSC			0.0480 BSC		
E	2.032	2.108	2.184	0.0800	0.0830	0.0860
F	1.981 BSC			0.0780 BSC		
G	3.81 BSC			0.150 BSC		
H	2.667	2.718	2.769	0.1050	0.1070	0.1090
J	0.584 BSC			0.0230 BSC		
K	20.422	20.549	20.676	0.804	0.809	0.814
L	11.28 REF			0.444 REF		
M	0°	---	7°	0°	---	7°
N	4.57 REF			0.180 REF		
P	2.259	2.386	2.513	0.0889	0.0939	0.0989
Q	3.480 BSC			0.1370 BSC		
R	2.54 REF			0.100 REF		
S	0°	---	8°	0°	---	8°
U	6.17 REF			0.243 REF		
W	0°	---	6°	0°	---	6°
Y	2.388 BSC			0.0940 BSC		

- STYLE 1:  
PIN 1. BASE  
2. EMITTER  
3. COLLECTOR  
4. ANODE  
5. CATHODE

ThermalTrak is a trademark of Semiconductor Components Industries, LLC (SCILLC).

**ON Semiconductor** and  are registered trademarks of Semiconductor Components Industries, LLC (SCILLC). SCILLC reserves the right to make changes without further notice to any products herein. SCILLC makes no warranty, representation or guarantee regarding the suitability of its products for any particular purpose, nor does SCILLC assume any liability arising out of the application or use of any product or circuit, and specifically disclaims any and all liability, including without limitation special, consequential or incidental damages. "Typical" parameters which may be provided in SCILLC data sheets and/or specifications can and do vary in different applications and actual performance may vary over time. All operating parameters, including "Typicals" must be validated for each customer application by customer's technical experts. SCILLC does not convey any license under its patent rights nor the rights of others. SCILLC products are not designed, intended, or authorized for use as components in systems intended for surgical implant into the body, or other applications intended to support or sustain life, or for any other application in which the failure of the SCILLC product could create a situation where personal injury or death may occur. Should Buyer purchase or use SCILLC products for any such unintended or unauthorized application, Buyer shall indemnify and hold SCILLC and its officers, employees, subsidiaries, affiliates, and distributors harmless against all claims, costs, damages, and expenses, and reasonable attorney fees arising out of, directly or indirectly, any claim of personal injury or death associated with such unintended or unauthorized use, even if such claim alleges that SCILLC was negligent regarding the design or manufacture of the part. SCILLC is an Equal Opportunity/Affirmative Action Employer. This literature is subject to all applicable copyright laws and is not for resale in any manner.

### PUBLICATION ORDERING INFORMATION

**LITERATURE FULFILLMENT:**  
Literature Distribution Center for ON Semiconductor  
P.O. Box 61312, Phoenix, Arizona 85082-1312 USA  
**Phone:** 480-829-7710 or 800-344-3860 Toll Free USA/Canada  
**Fax:** 480-829-7709 or 800-344-3867 Toll Free USA/Canada  
**Email:** orderlit@onsemi.com

**N. American Technical Support:** 800-282-9855 Toll Free  
USA/Canada

**Japan:** ON Semiconductor, Japan Customer Focus Center  
2-9-1 Kamimeguro, Meguro-ku, Tokyo, Japan 153-0051  
**Phone:** 81-3-5773-3850

**ON Semiconductor Website:** <http://onsemi.com>

**Order Literature:** <http://www.onsemi.com/litorder>

For additional information, please contact your local Sales Representative.