

MODEL:

# PDU3VSR6L1530

## 3-Phase Switched Rackmount PDU



208V  
3-Phase Input



NEMA L15-30P  
Plug



208V Single-  
Phase Output



30 Outlets



C13



8.6kW Load  
Capacity



Multimode  
Load Meter



Network  
Interface



0U  
Rackmount



Toolless  
Mounting  
Buttons

- A** Multimode Load Meter
- B** C13 and C19 Outlets with Multi-Function LEDs
- C** 20A 2-Pole Hydraulic Magnetic Circuit Breakers
- D** C13 and C19 Plug Inserts
- E** Removable Mounting Brackets
- F** Toolless Mounting Buttons with Removable 90° Rotation Brackets
- G** 6 ft. Input Power Cord
- H** NEMA L15-30P Input Plug
- I** Durable Metal Case
- J** Network Interface
- K** RJ45 Ethernet Jack
- L** Manual Configuration Port
- M** Environmental Monitoring Port
- N** Network Interface Reset Button

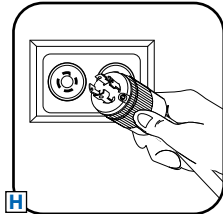

AC Input Connection: Insert NEMA L15-30P plug into compatible utility, generator or UPS outlet.

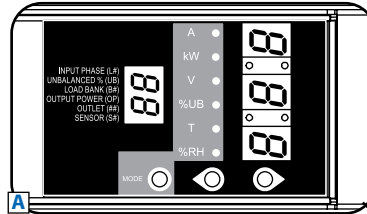

Multimode Load Meter: Display the load for any phase, bank or outlet, display temperature or humidity\*, display the IP address or rotate the display 180°.

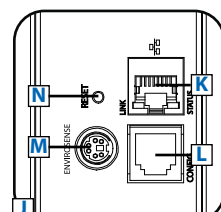
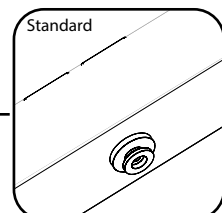
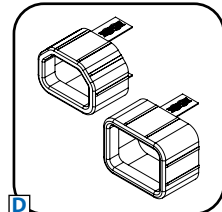
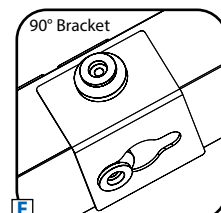
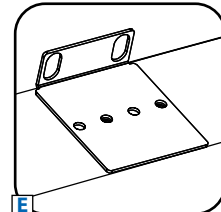
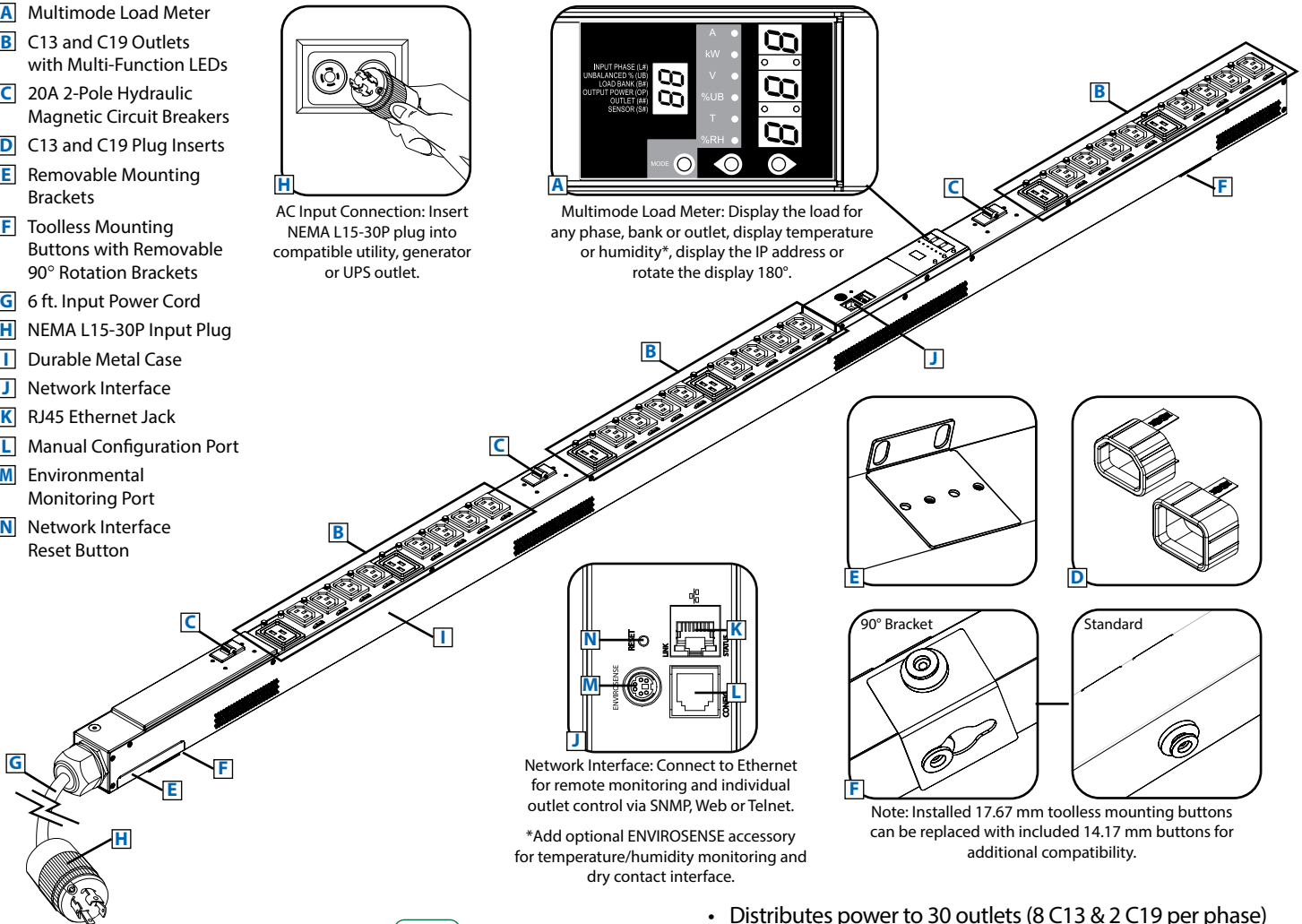

Network Interface: Connect to Ethernet for remote monitoring and individual outlet control via SNMP, Web or Telnet.

\*Add optional ENVIROSENSE accessory for temperature/humidity monitoring and dry contact interface.

Note: Installed 17.67 mm toolless mounting buttons can be replaced with included 14.17 mm buttons for additional compatibility.

### Specifications

Model	PDU3VSR6L1530
Voltage	208V (3-Phase Input/Single-Phase Output)
Frequency	50 / 60 Hz
Load Capacity	8.6kW
Input Plug	NEMA L15-30P
Input Cord Length	6 ft.
Outlets	30 (24 C13 / 6 C19)
Primary Mounting Option	0U (Vertical) Rackmount
Unit Weight & Dimensions	16.5 lbs / 70 x 2.17 x 2.86 (HxWxD in inches) <i>See next page for detailed unit measurements.</i>
Standards	Tested to UL 60950-1 (US & Canada), NOM (Mexico), FCC Class A, TAA Compliant

Tripp Lite has a policy of continuous improvement. Specifications are subject to change without notice.



- Distributes power to 30 outlets (8 C13 & 2 C19 per phase)
- Remote monitoring and control via SNMP, Web or Telnet
- Displays load for *each bank, phase, and outlet* in real time
- Perfect for rackmount server, network and telecom applications

**SEE NEXT PAGE FOR DETAILED UNIT MEASUREMENTS**



1111 W. 35th Street  
Chicago, IL 60609 USA  
773.869.1234  
www.tripplite.com

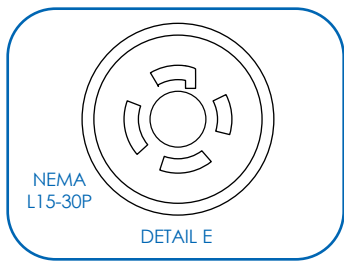
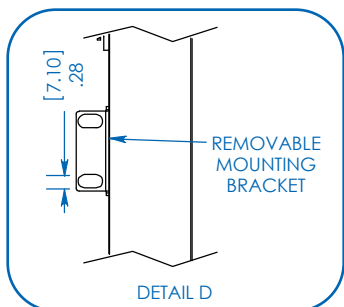
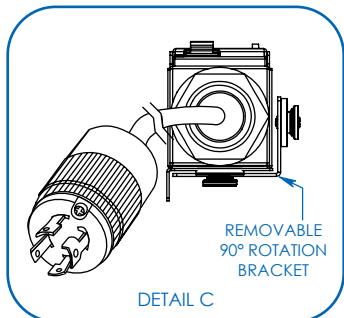
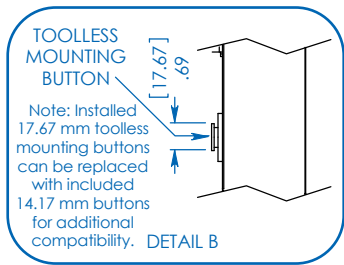
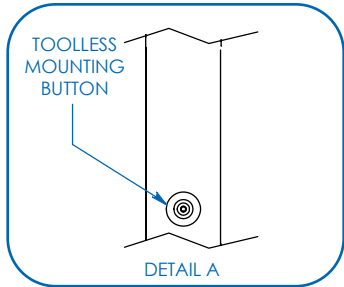
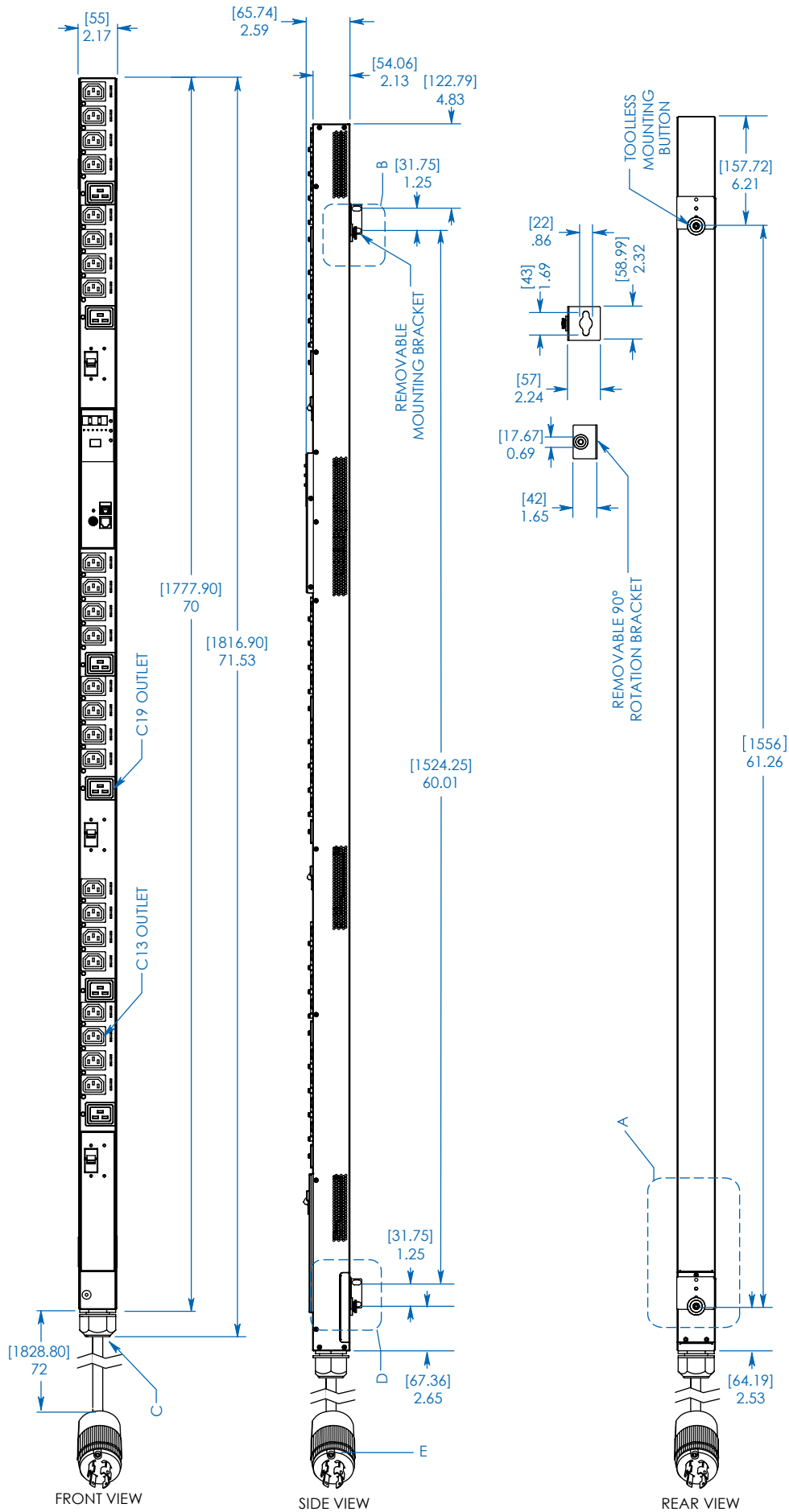

Dimensions: [mm] INCHES

Tripp Lite has a policy of continuous improvement. Specifications are subject to change without notice.

MODEL:  
**PDU3VSR6L1530**



1111 W. 35th Street  
Chicago, IL 60609 USA  
773.869.1234

[www.tripplite.com](http://www.tripplite.com)