

PRODUCT NUMBER SEE SHEET 2

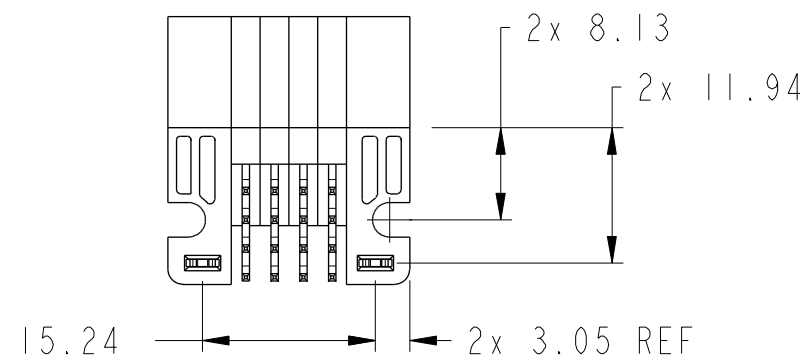
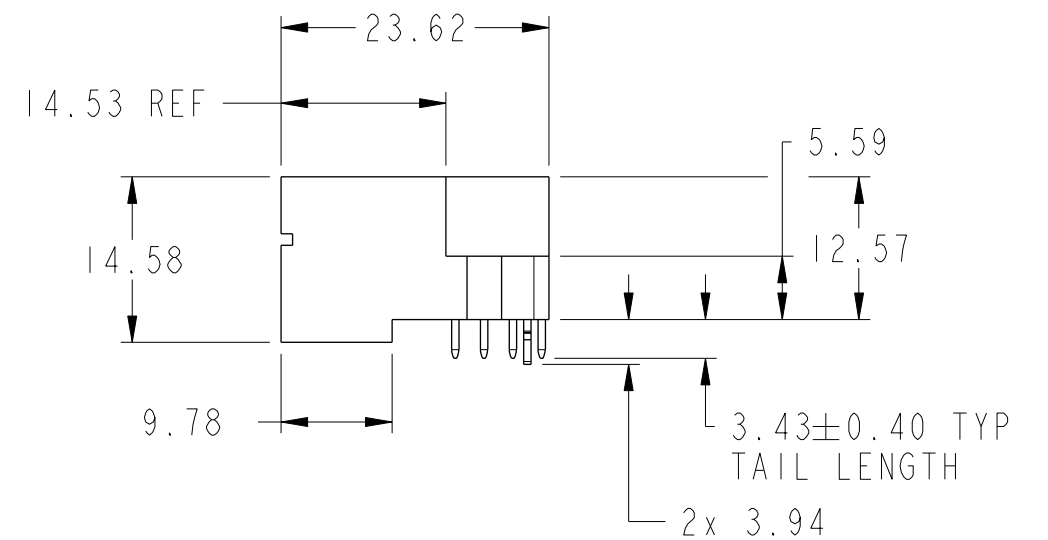
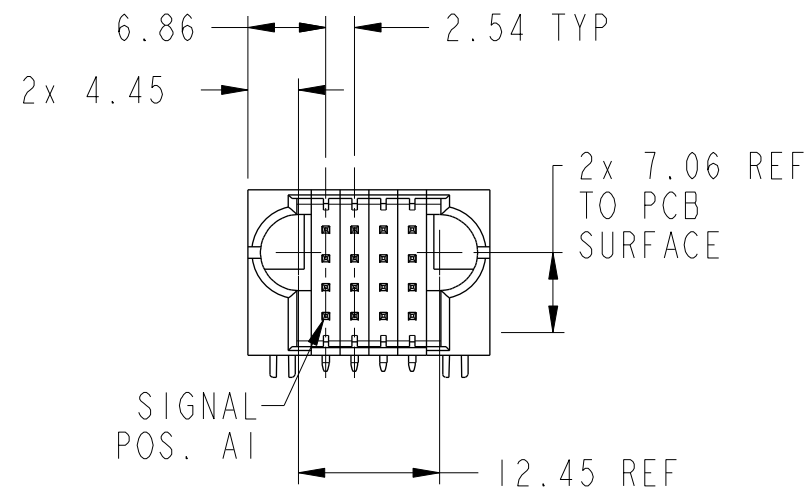
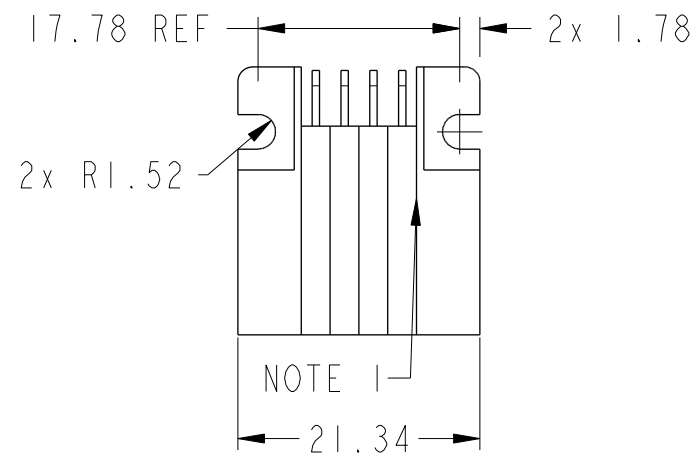

Copyright FCI.

spec ref	*	dr	Rainbow Zhan	2015/01/07	projection	MM	size	A3	scale	3:2																	
tolerance std	ASME Y14.5	eng	Rainbow Zhan	2015/01/14			ecn no	-	rel level	Released																	
TOLERANCES UNLESS OTHERWISE SPECIFIED		chr	-	-			product family	PwrBlade+	rel level	Released																	
surface	<table border="1"> <tr> <td>linear</td> <td>0.X</td> <td>±0.5</td> </tr> <tr> <td></td> <td>0.XX</td> <td>±0.25</td> </tr> <tr> <td></td> <td>0.XXX</td> <td>±0.10</td> </tr> <tr> <td>angular</td> <td>0°</td> <td>±2°</td> </tr> </table>	linear	0.X	±0.5		0.XX	±0.25		0.XXX	±0.10	angular	0°	±2°		<table border="1"> <tr> <td>title</td> <td>16S</td> <td>dwg no</td> <td>10106262-0004001</td> <td>rev</td> <td>A</td> </tr> <tr> <td>www.fci.com</td> <td>cat. no.</td> <td>Product - Customer Drw</td> <td>sheet 1 of 3</td> <td></td> <td></td> </tr> </table>	title	16S	dwg no	10106262-0004001	rev	A	www.fci.com	cat. no.	Product - Customer Drw	sheet 1 of 3		
linear	0.X	±0.5																									
	0.XX	±0.25																									
	0.XXX	±0.10																									
angular	0°	±2°																									
title	16S	dwg no	10106262-0004001	rev	A																						
www.fci.com	cat. no.	Product - Customer Drw	sheet 1 of 3																								

PRODUCT NO.	ROWS	SIGNAL				
		E1	1	2	3	4
10106262-0004001LF	DCBA	HUUU				
		TTTT				
		SSSS				
		RRRR				

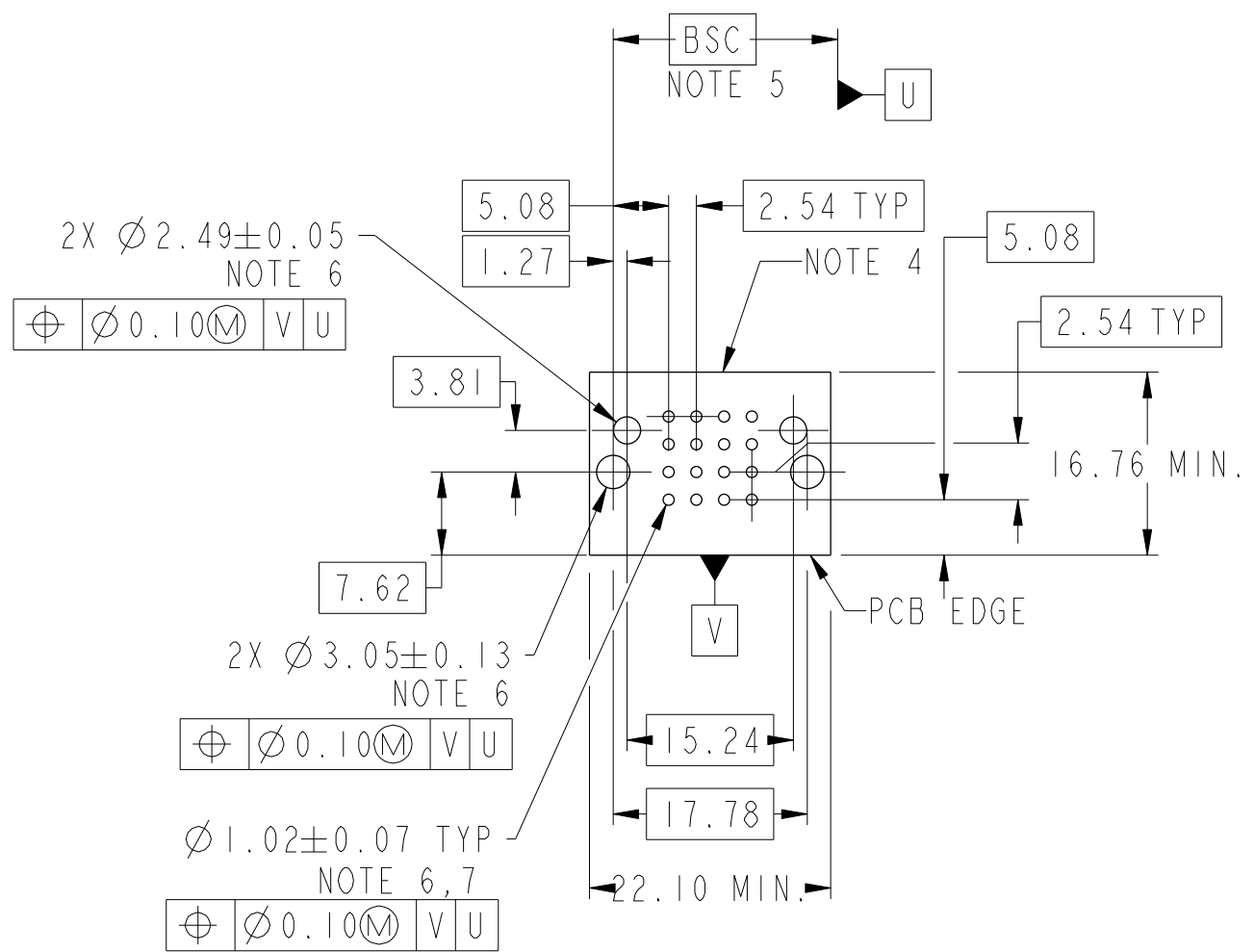

CODE	DESCRIPTION
H	MLBF SIGNAL CONTACT, ROW D (3.43)
HA	METAL HOLD DOWN
R	STD SIGNAL CONTACT, ROW A (3.43)
S	STD SIGNAL CONTACT, ROW B (3.43)
T	STD SIGNAL CONTACT, ROW C (3.43)
U	STD SIGNAL CONTACT, ROW D (3.43)

dr	Rainbow Zhan	2015/01/07	projection	MM	size	A3	scale	3:2
eng	Rainbow Zhan	2015/01/14			ecn no		-	
chr	-	-			rel level		Released	
appr	Pei-Ming Zheng	2015/01/14	product family		PwrBlade+		-	
			title		16S		rev	
www.fci.com			cat. no.		Product - Customer Drw		sheet 2 of 3	
			RA STB HEADER		dwg no		10106262-0004001	
							A	



Copyright FCI.

NOTES:

- 1) "FCI", PART NUMBER AND DATE CODE TO BE MARKED ON THIS SURFACE.
THE MARK CAN BE OMITTED IF THERE IS NOT ENOUGH SPACE ON THIS SURFACE.
- 2) MATERIALS:
-HOUSING - GLASS FILLED WITH HIGH TEMP THERMOPLASTIC, UL94V-0.
-SIGNAL CONTACT - COPPER ALLOY.
-POWER CONTACT - HIGH CONDUCTIVITY COPPER ALLOY.
- 3) PLATING SPECIFICATION REFER TO FCI 10116351
- 4) DENOTES CONNECTOR KEEP OUT ZONE.
- 5) DATUM AND BASIC DIMENIONS WERE ESTABLISHED BY CUSTOMER.
- 6) ALL HOLE DIAMETERS ARE FINISHED HOLE SIZES.
- 7) 1.15 ± 0.025 MM DRILLED HOLE PLATED WITH 0.00762MM MIN Sn
OVER 0.0254-0.0762MM Cu PLATING TO ACHIEVE A 1.02 ± 0.07 MM HOLE.
- 8) PRODUCT SPECIFICATION REFER TO FCI GS-12-658.
APPLICATION SPECIFICATION REFER TO FCI GS-20-141.
PRODUCT PACKAGED IN TRAYS, REFER TO FCI GS-14-1502.

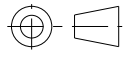

Copyright FCI.

dr	Rainbow Zhan	2015/01/07	projection 	MM 	size	A3	scale	3:2	
eng	Rainbow Zhan	2015/01/14			ecn no	-			
chr	-	-			rel level	Released			
appr	Pei-Ming Zheng	2015/01/14	product family	PwrBlade+					
		title	16S RA STB HEADER		dwg no	10106262-0004001		rev	A
www.fci.com		cat. no.	Product - Customer Drw			sheet 3 of 3			