

# SPECIFICATION

Part Number: **G30.B.108111**

Product Name: Olympian Direct Mount Ultra Wide-Band LTE/Cellular/CDMA Antenna  
For 2G/3G/4G Applications  
LTE/GSM/CDMA/DCS/PCS/WCDMA/UMTS/HSDPA/GPRS/EDGE/IMT  
698 to 960MHz and 1710 to 2700MHz

Features: Heavy duty screw mount  
UV and vandal resistant ABS housing and thread  
IP67 compliant  
Standard is 1M RG-316 SMA(M)  
Cables and Connectors Customizable

**RoHS Compliant**



## 1. INTRODUCTION

The G30 Olympian is a high performance screw mount wide-band cellular antenna for external use on vehicles and outdoor assets worldwide. Omni-directional high gain and high efficiency across all bands ensures constant reception and transmission. This is vital for today's high data bandwidth applications in video and mobile broadband.

Durable UV resistant ABS housing is resistant to vandalism and direct attack. At only 48mm height it complies with the latest EU height restrictions directives for roof-mounted objects. This antenna is mounted on metal and plastic structures and is locked from the inside of the structure by a nut. Adhesive foam at the base provides a watertight seal to the mounting structure. High quality waterproof and corrosion resistant Teflon jacket RG316 is used for the cable.

Two of these G30 separated at distance from each other are ideal for the latest LTE MIMO spatial diversity applications.

For longer cable lengths and if 700mhz band is required, it is necessary to use the MA740 Pantheon for 2G/3G/4G or the FXP741 2g/3G/4G MIMO Pantheon.

## 2. SPECIFICATION

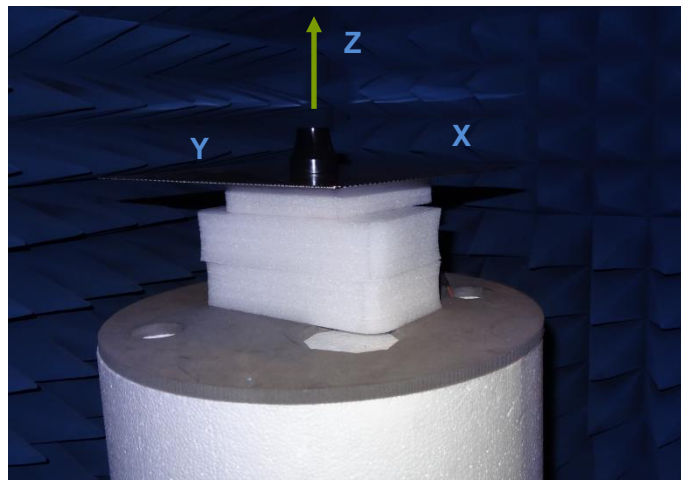
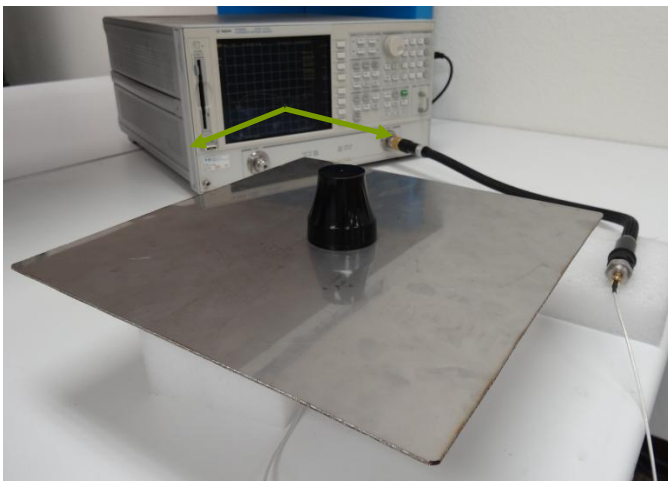
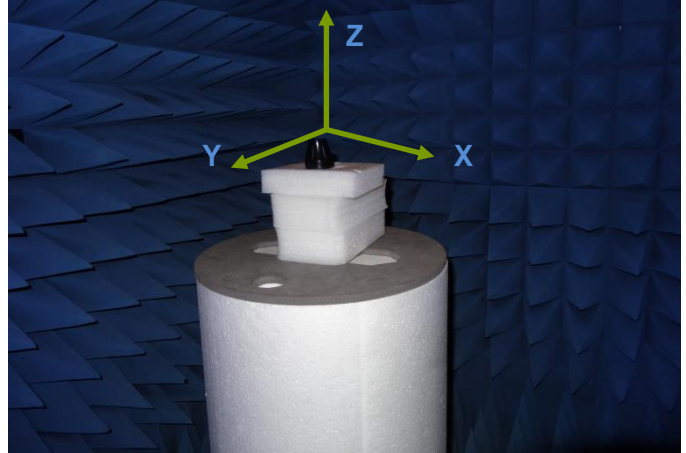
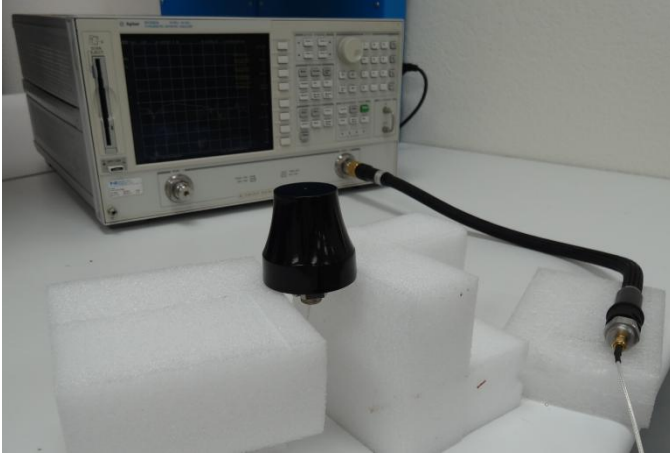
ELECTRICAL			
ANTENNA	G30		
STANDARD	2G/3G/4G		
Operation Frequency (MHz)	698~960 MHz	1710~2170 MHz	2500~2800MHz
Peak Gain	1.2 dBi	3.2dBi	2.5dBi
Average Gain	-4.5 dB	-2.5dB	-4.5dB
Efficiency	40%	55%	40%
VSWR	<3.0:1		
Impedance	50Ω		
Polarization	Linear		
Radiation Properties	Omni-directional		
Max Input Power	5 W		

\* The G30 antenna performance was measured with 30X30 cm metal plate.

MECHANICAL	
Dimensions (mm)	Height=48mm and Diameter=50mm
Cable	Length=1m RG316- Fully Customizable
Casing	UV Resistant ABS
Base and Thread	Nickel plated Copper
Weather proof gasket	CR4305 foam with 3M9448B double-side adhesive
Connector	SMA(M) Fully Customizable
Nut	Nut M12
Sealant	Rubber Stopper

ENVIRONMENTAL	
Protection	IP67 Waterproof
Corrosion	5% NACI for 96hrs- Nickel plated steel base and thread
Temperature Range	40°C to +85°C
Thermal Shock	100 cycles -40 C to +85 C
Humidity	Non-condensing 65 C 95% RH
Shock (Drop Test)	1m drop on concrete 6 axes
Cable Pull	8Kgf

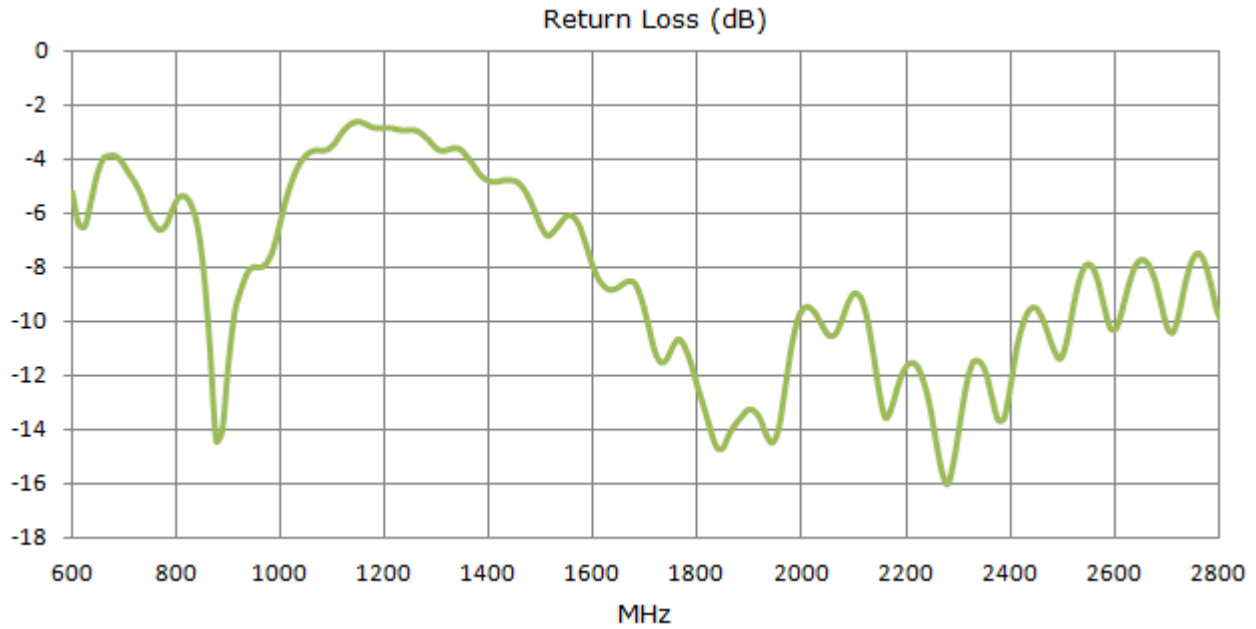
### 3. TEST SET UP



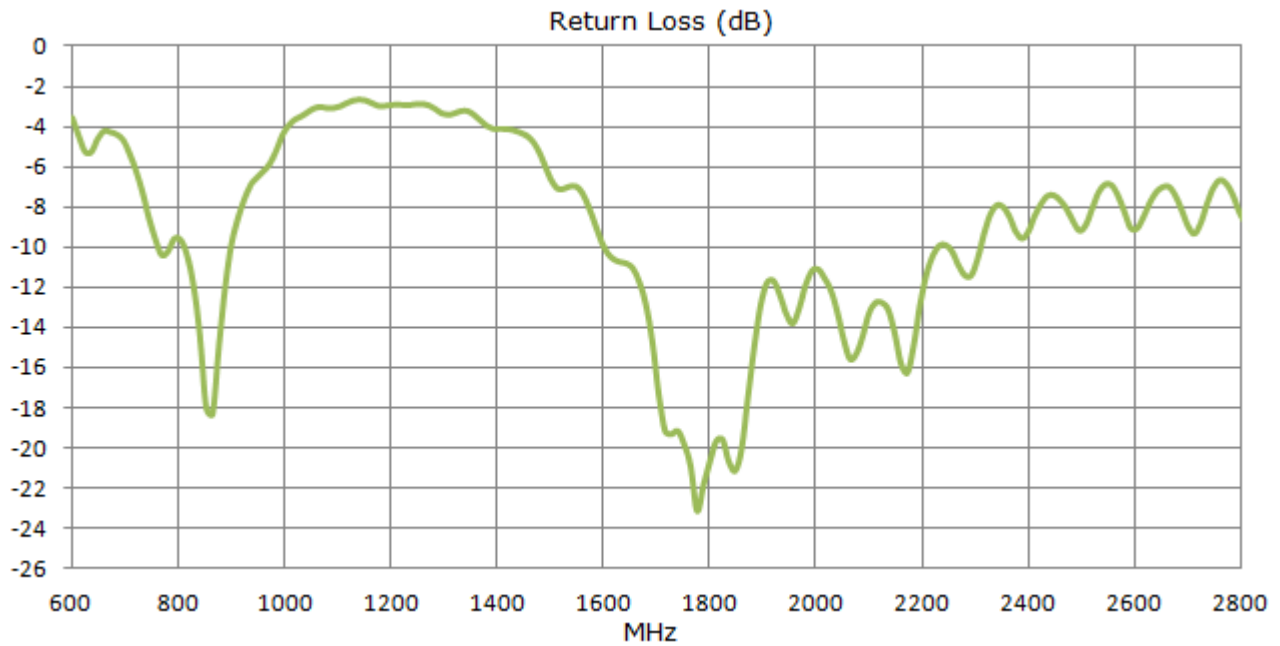
**Figure 1.** Impedance Test Setup of G30 Antenna in Free Space, 30cmx30cm metal plate (left hand) and peak gain, average gain, efficiency and radiation pattern measurements (right hand)

## 4. ANTENNA PARAMETERS

### 4.1. Return Loss

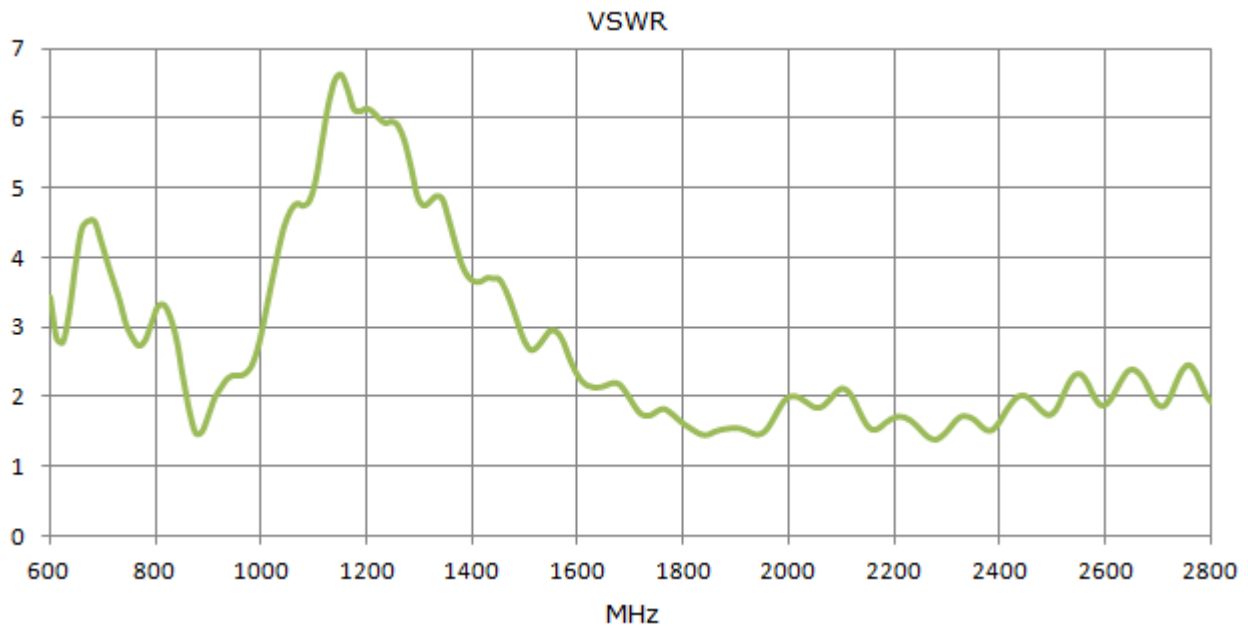


**Figure 2.** Return loss of G30 Antenna in Free Space

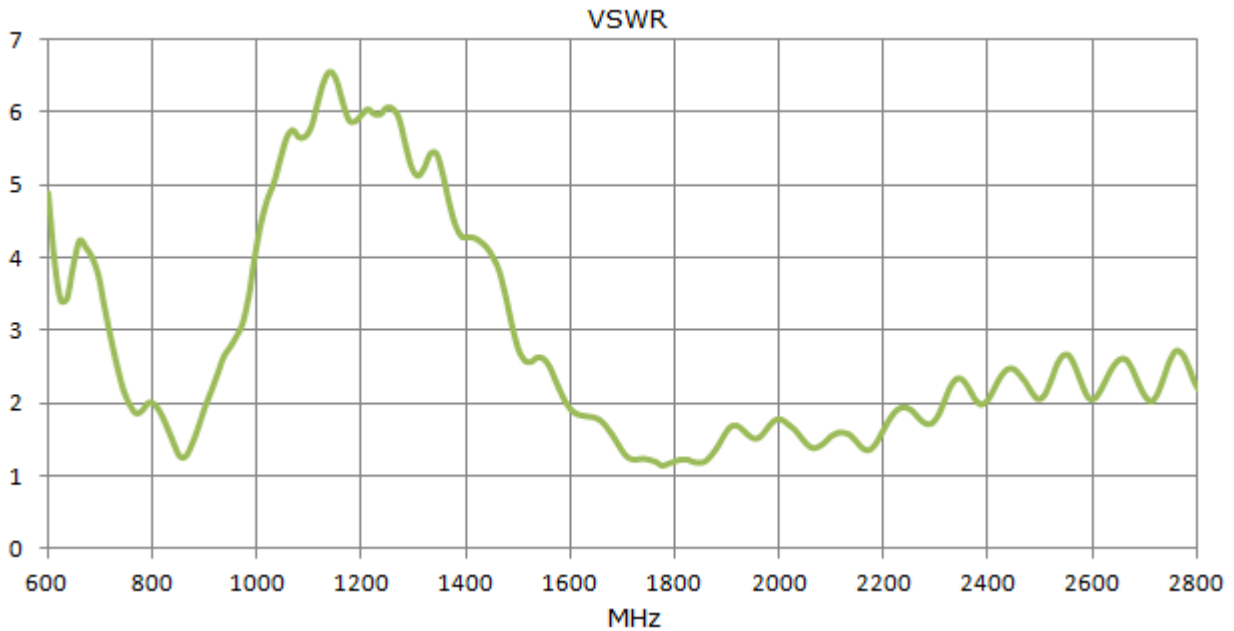


**Figure 3.** Return Loss of G30 Antenna on 30x30cm metal

## 4.2. VSWR

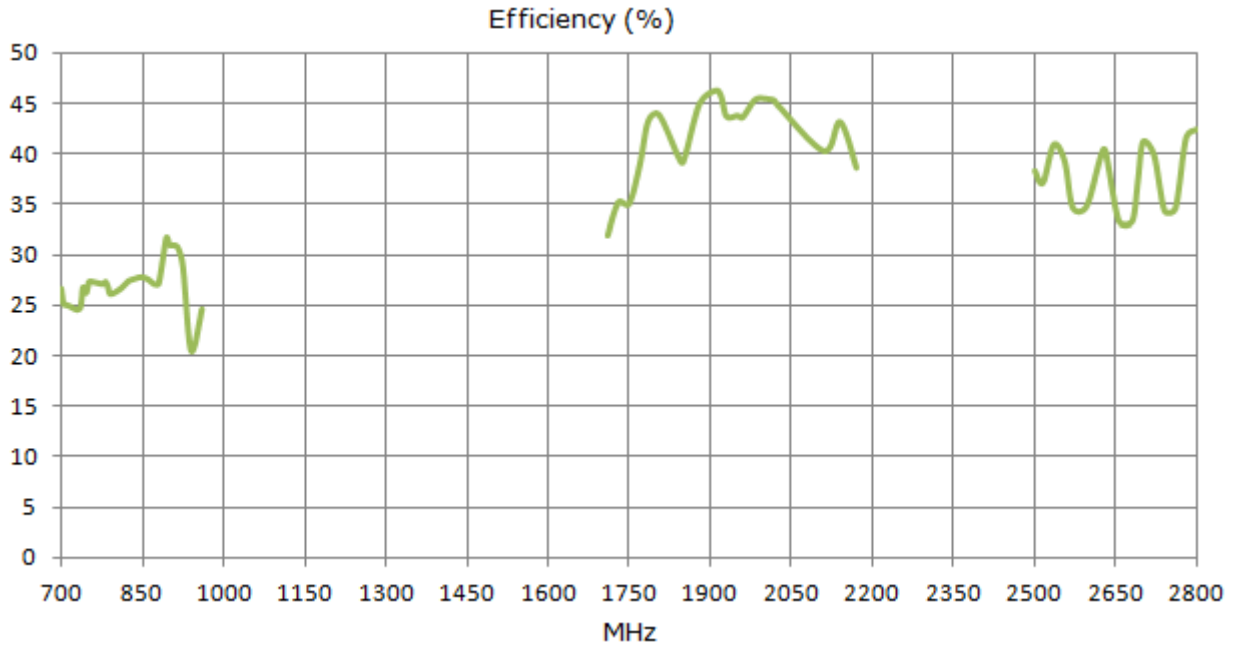


**Figure 4.** VSWR of G30 Antenna in Free Space

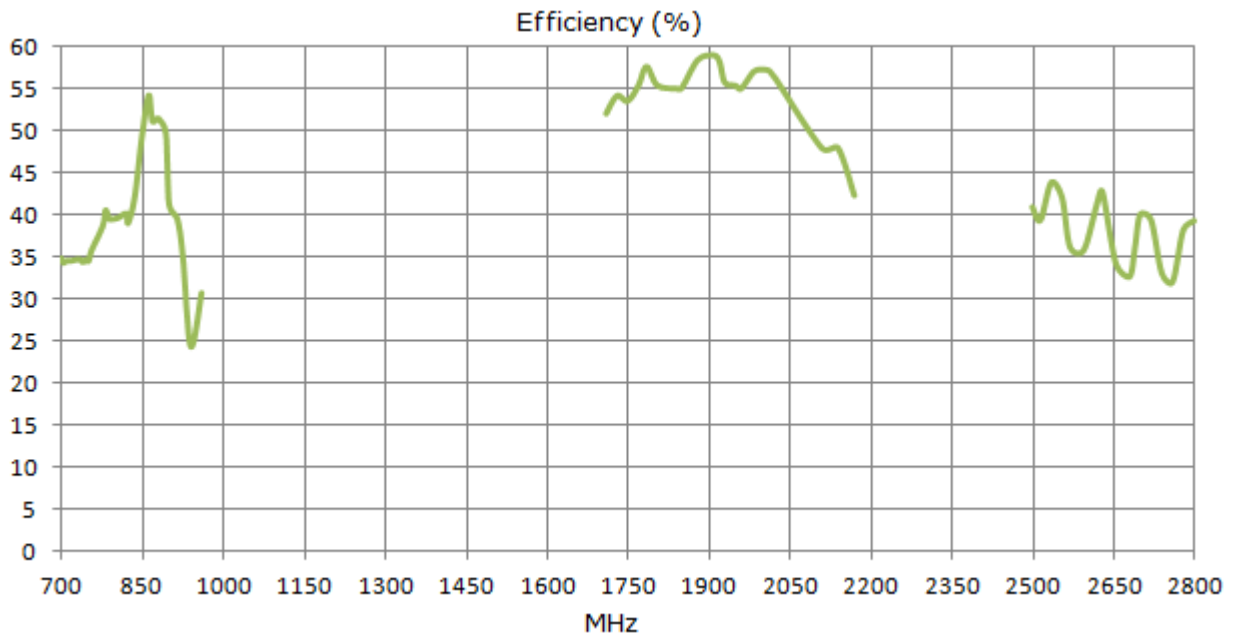


**Figure 5.** VSWR of G30 Antenna on 30x30cm metal

### 4.3. Efficiency

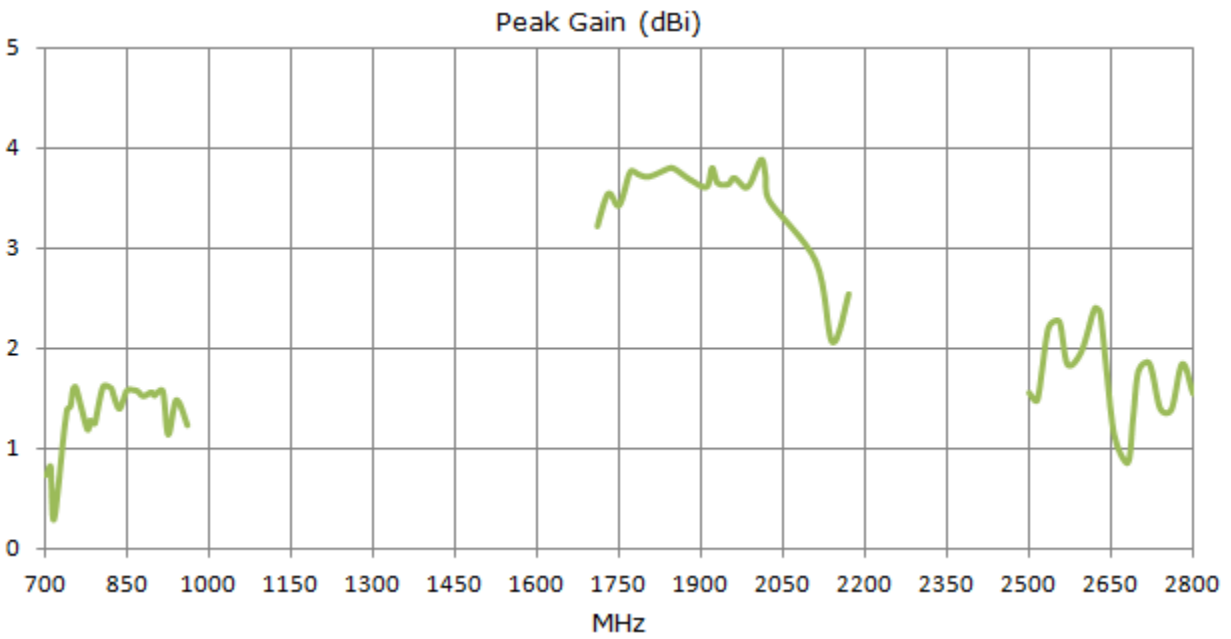


**Figure 6.** Efficiency of G30 Antenna in Free Space

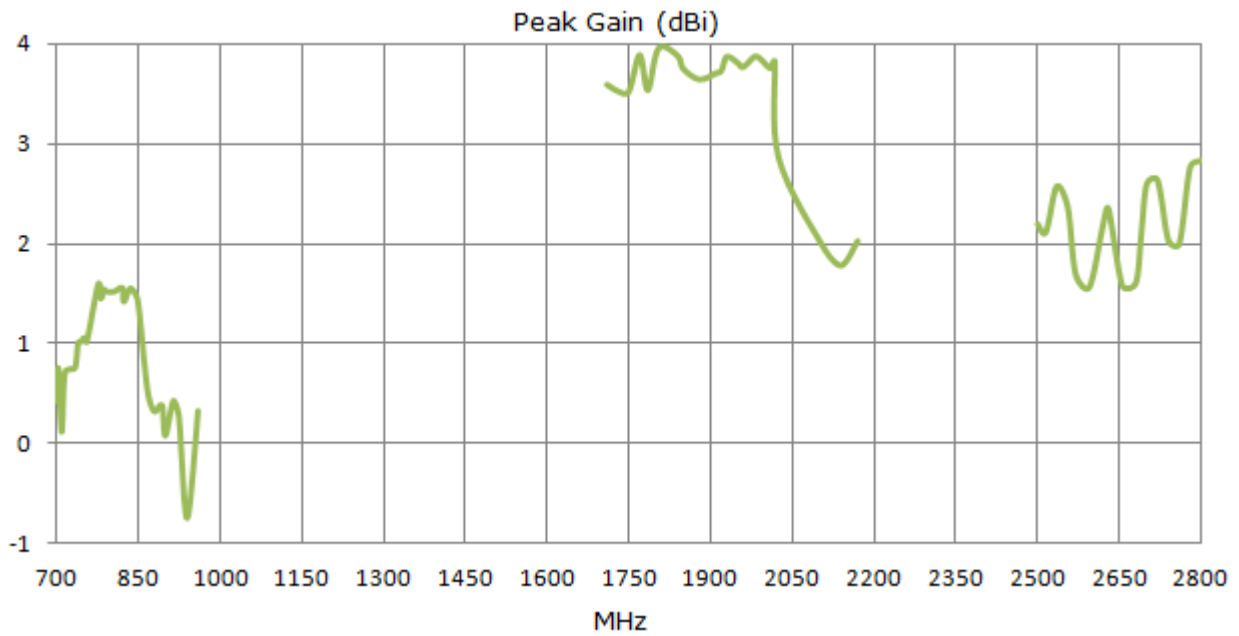


**Figure 7.** Efficiency of G30 Antenna on 30x30cm metal

## 4.4. Peak Gain



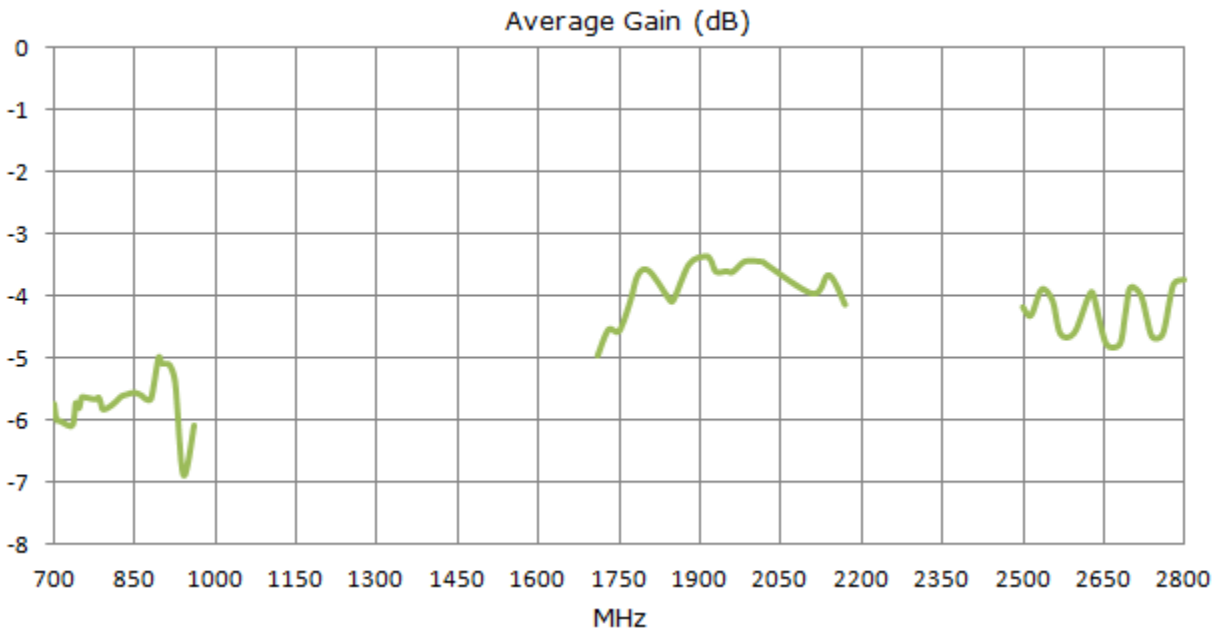
**Figure 8.** Peak Gain of G30 Antenna in Free Space



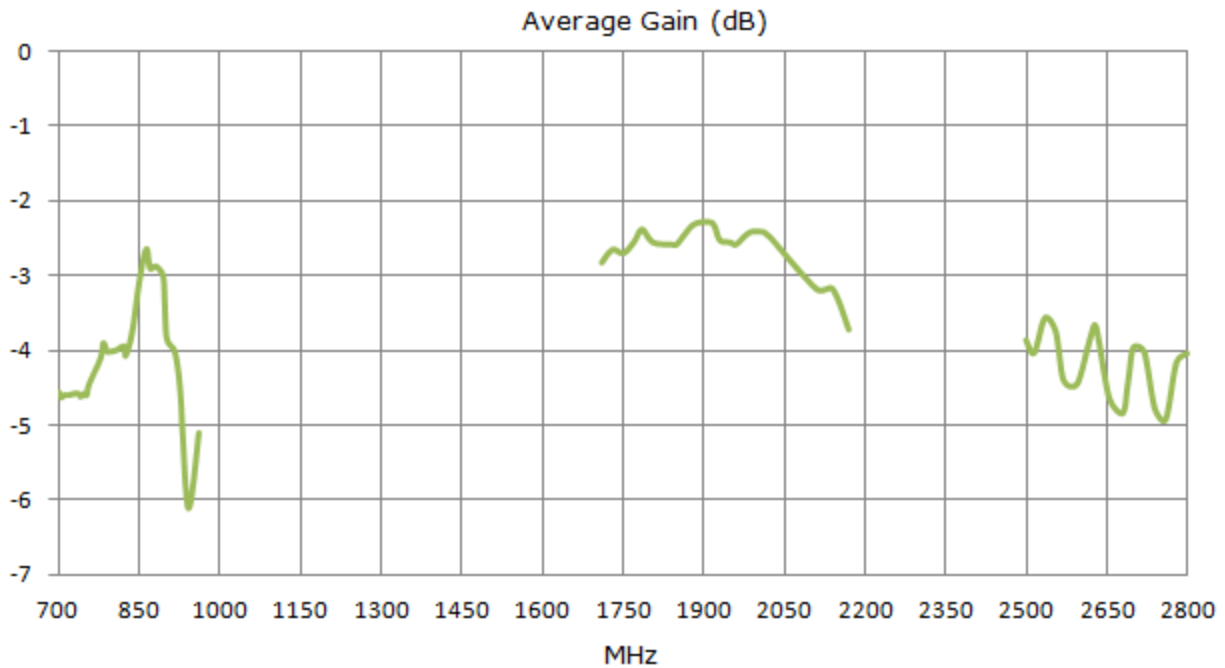
**Figure 9.** Peak Gain of G30 Antenna on 30x30cm metal



## 4.5. Average Gain

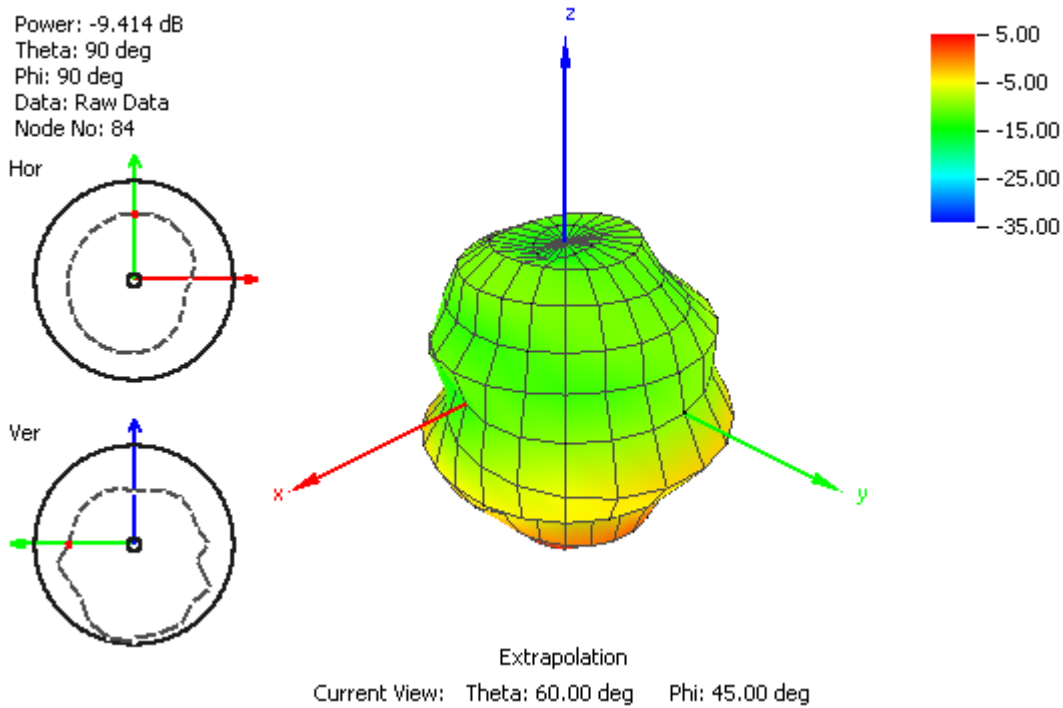


**Figure 10.** Average Gain of G30 Antenna in Free Space

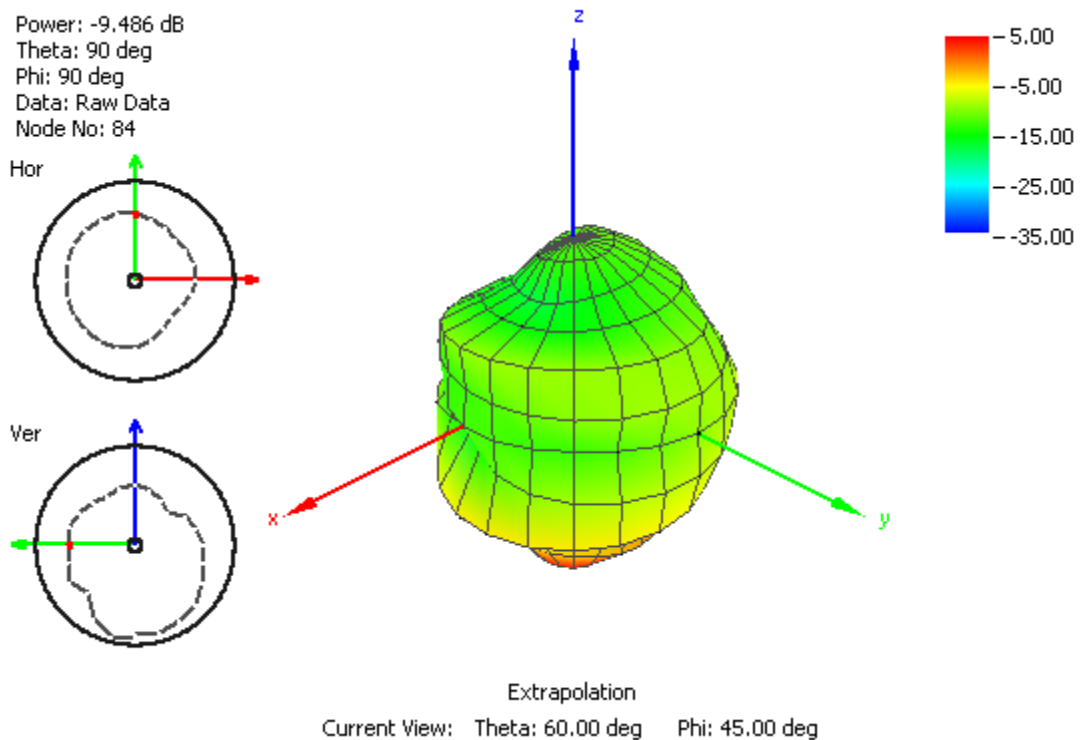


**Figure 11.** Average Gain of G30 Antenna on 30x30cm metal .

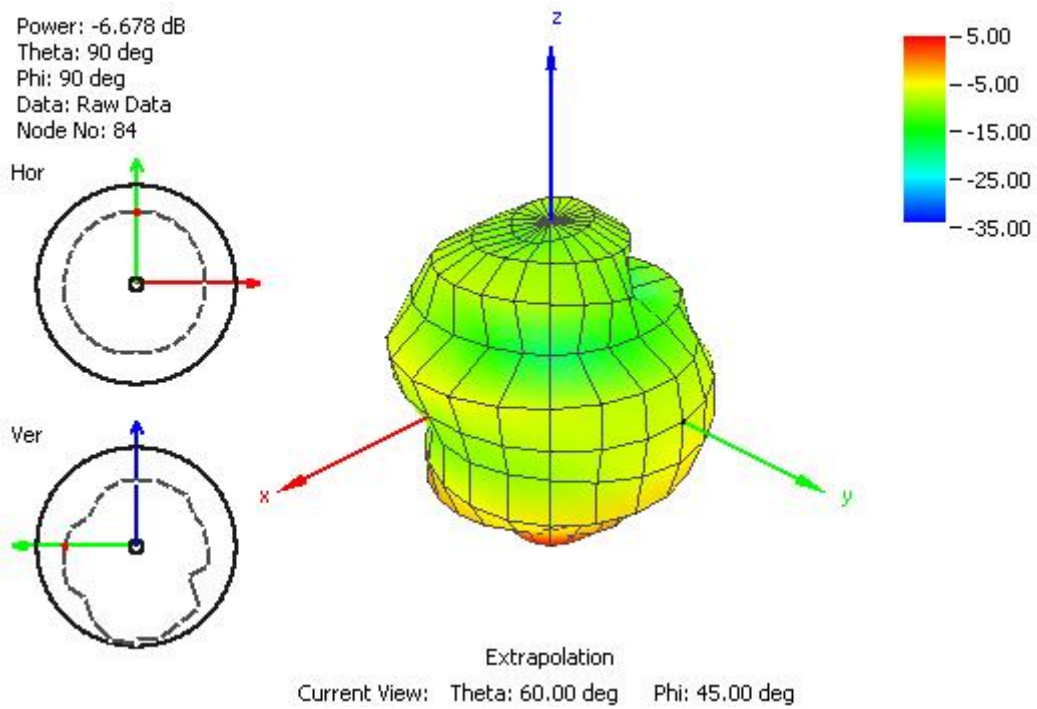
## 4.6. Radiation Pattern



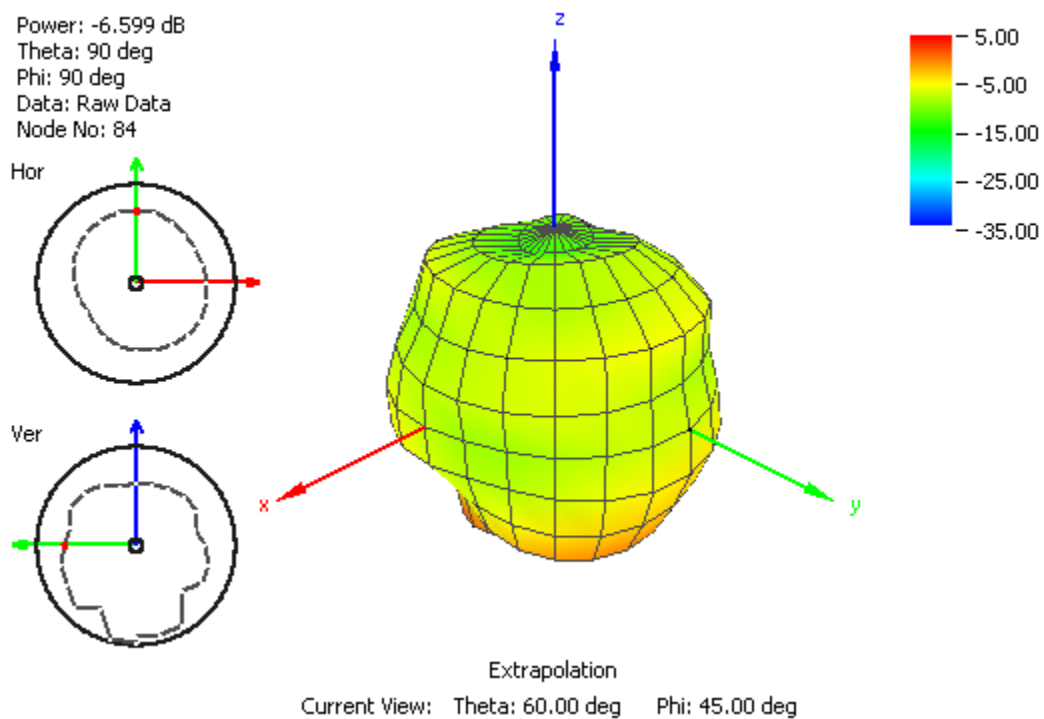
**Figure 12.** Radiation Pattern at 751 MHz of G30 Antenna in Free Space



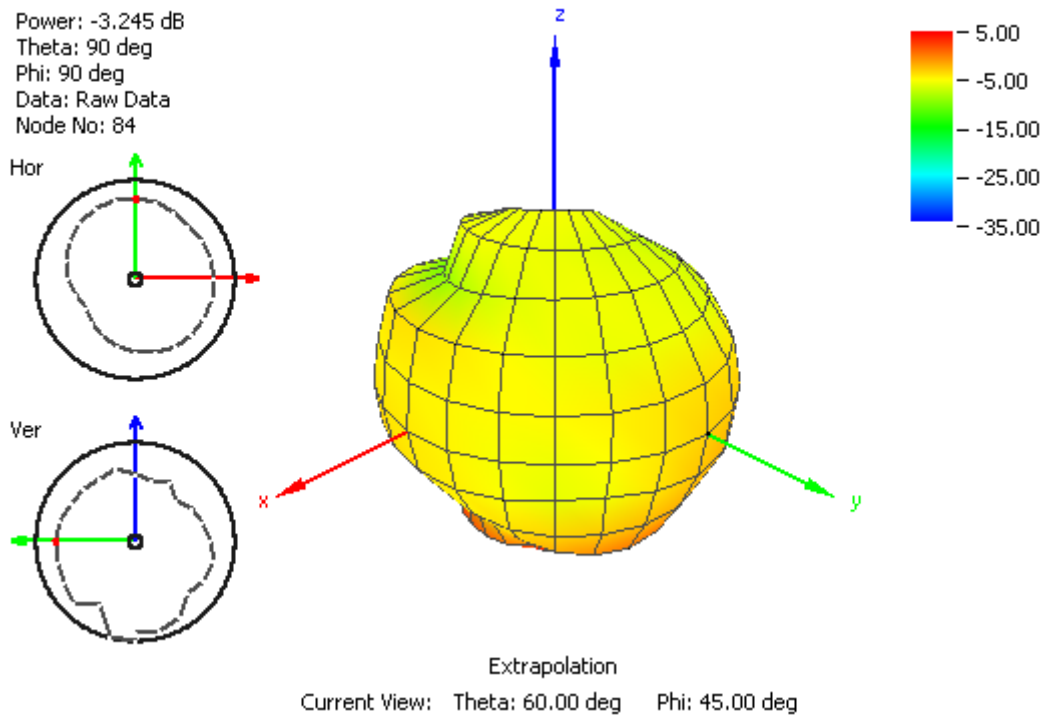
**Figure 13.** Radiation Pattern at 849 MHz of G30 Antenna in Free Space



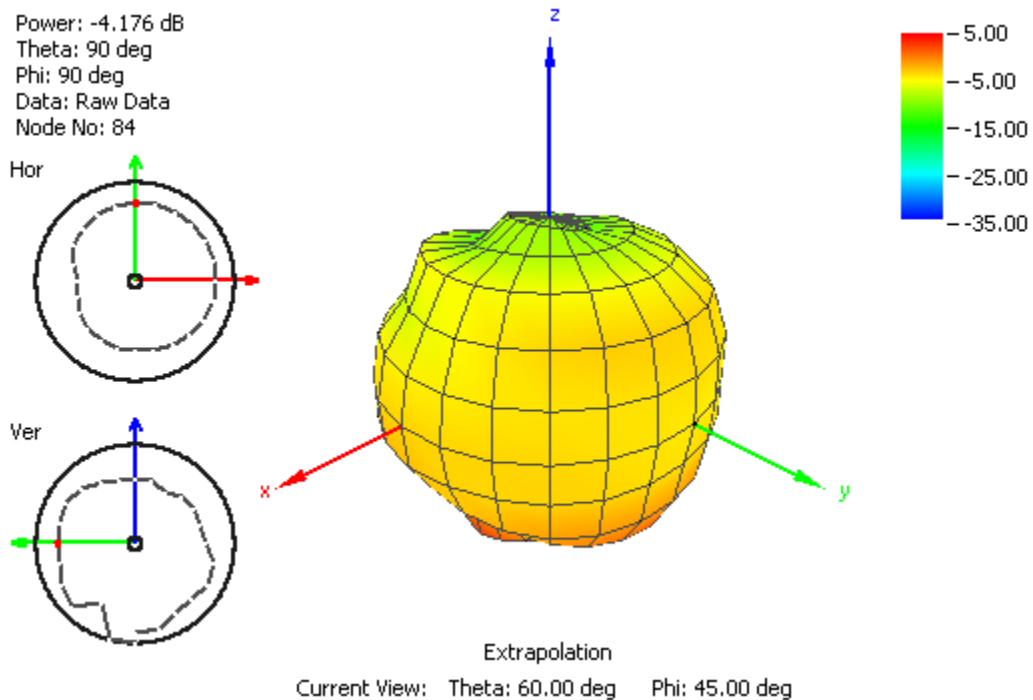
**Figure 14.** Radiation Pattern at 915 MHz of G30 Antenna in Free Space



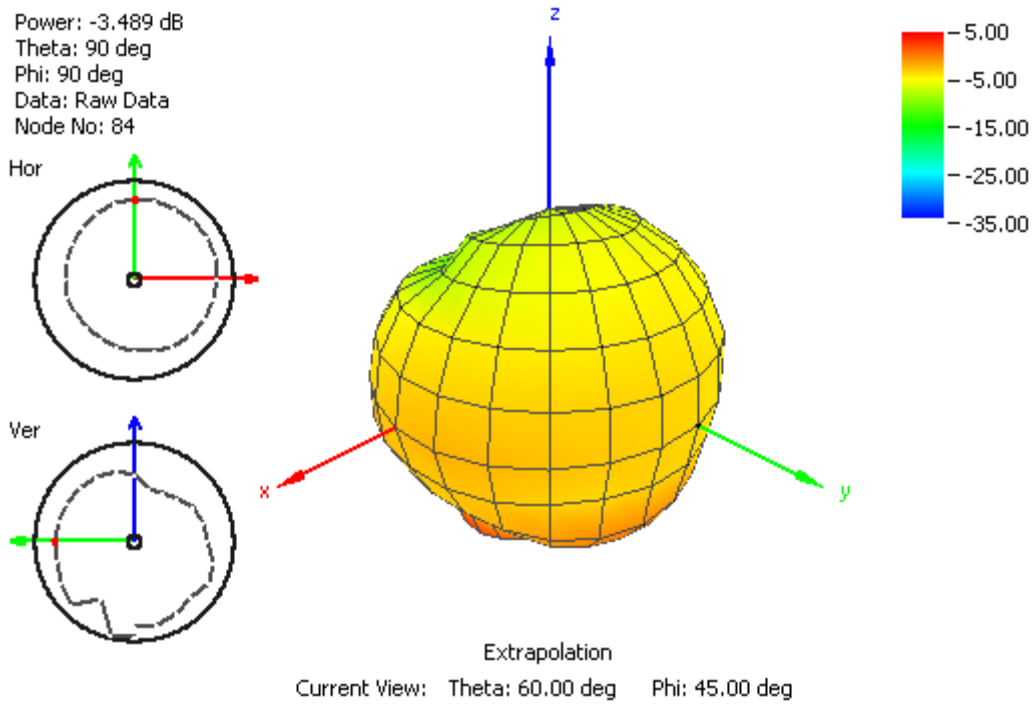
**Figure15.** Radiation Pattern at 1710 MHz of G30 Antenna in Free Space



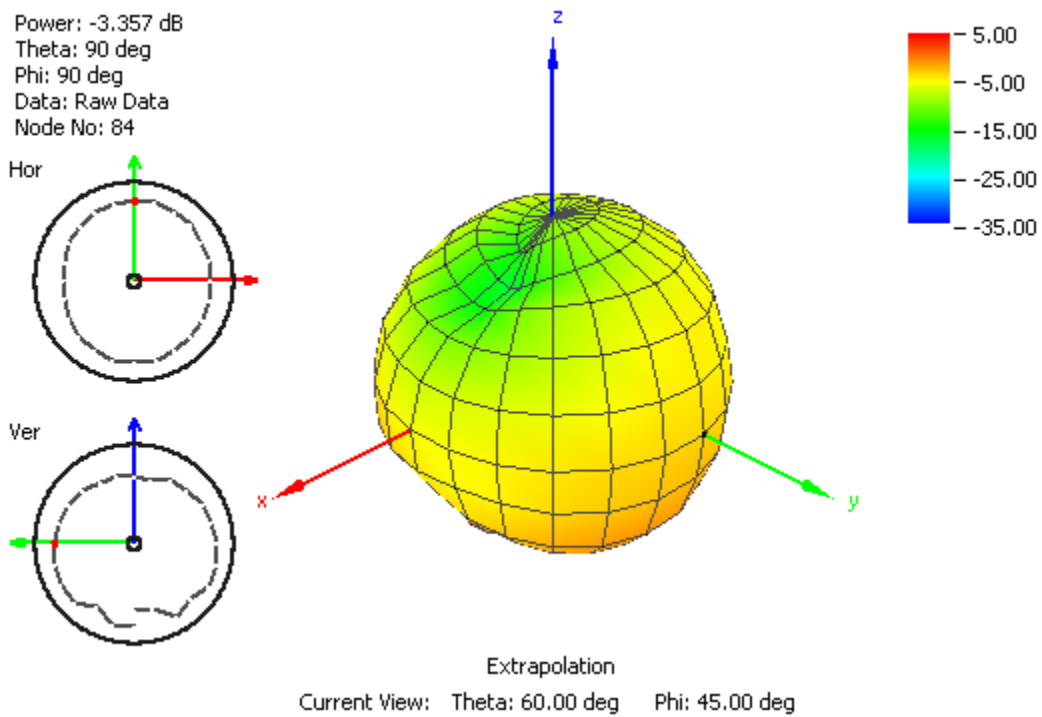
**Figure 16.** Radiation Pattern at 1805 MHz of G30 Antenna in Free Space



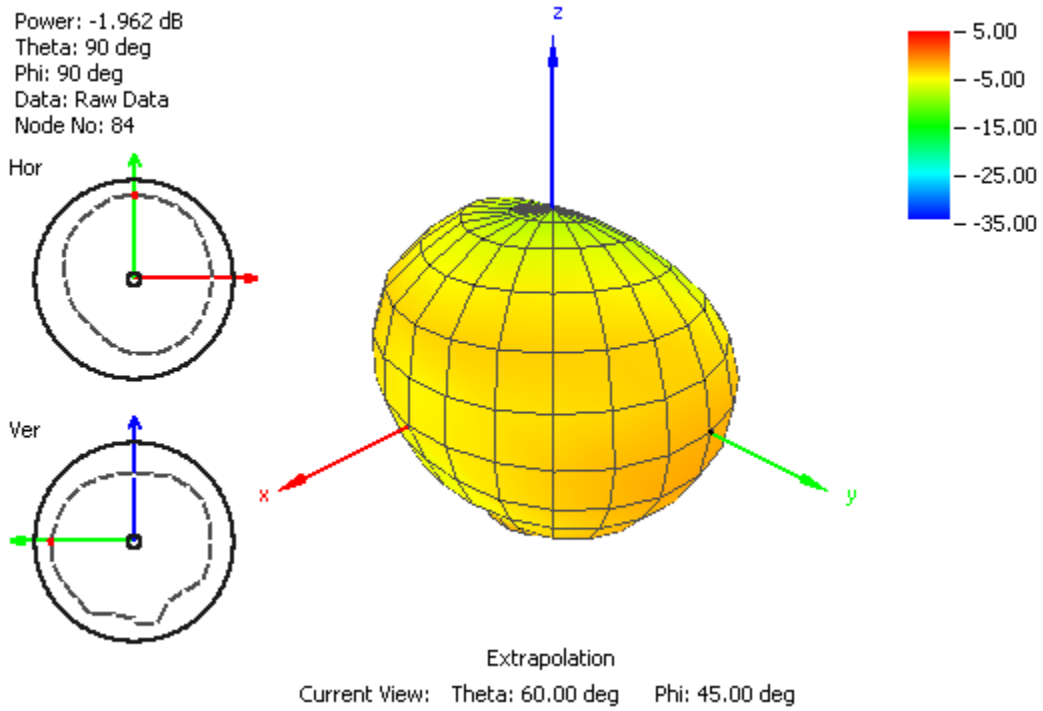
**Figure 17.** Radiation Pattern at 1910 MHz of G30 Antenna in Free Space



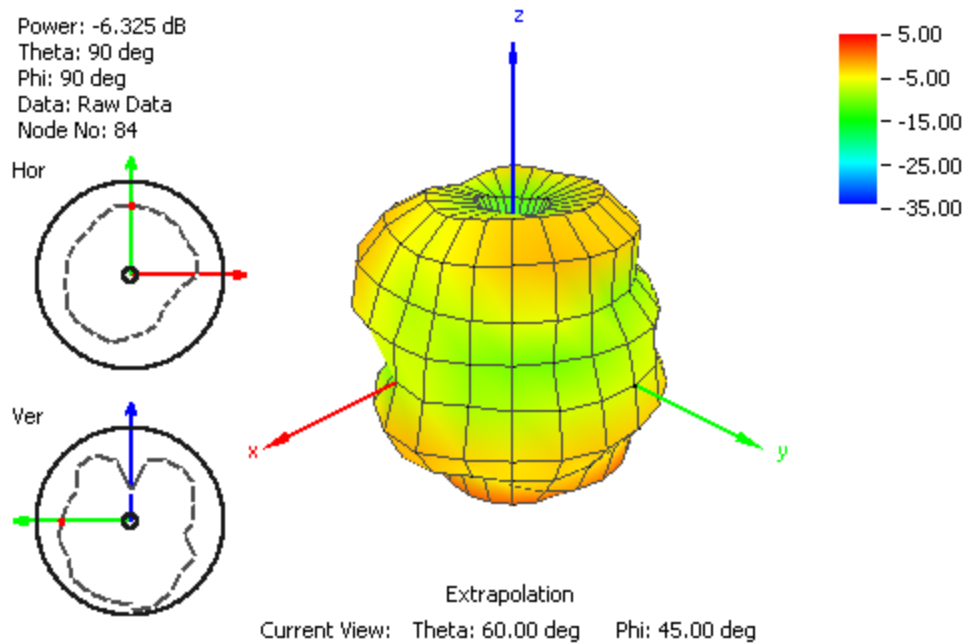
**Figure 18.** Radiation Pattern at 1990 MHz of G30 Antenna in Free Space



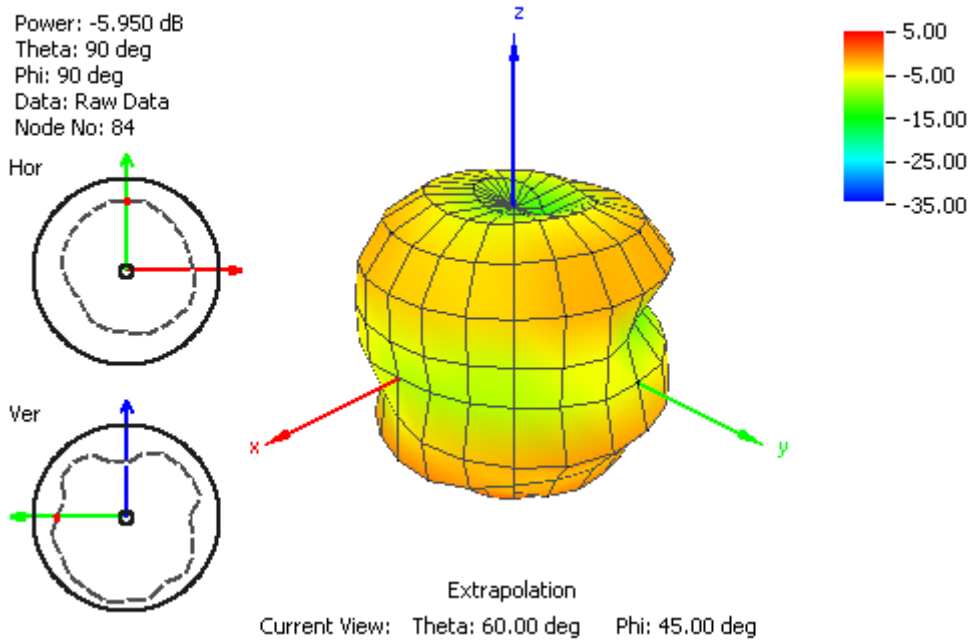
**Figure 19.** Radiation Pattern at 2100 MHz of G30 Antenna in Free Space



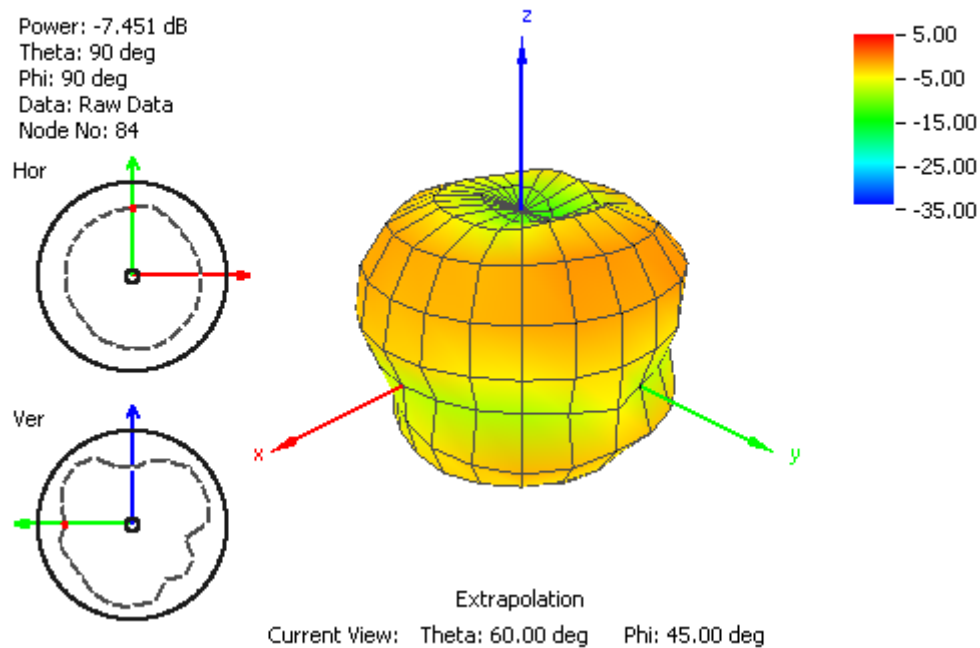
**Figure 20.** Radiation Pattern at 2600 MHz of G30 Antenna in Free Space



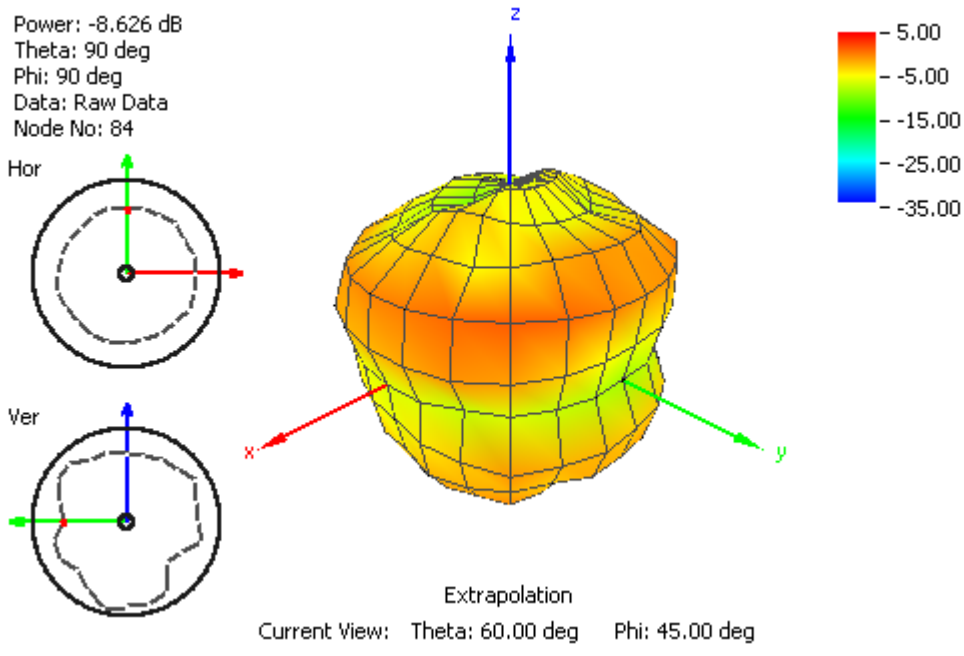
**Figure 21.** Radiation Pattern at 751 MHz of G30 Antenna on 30x30cm metal



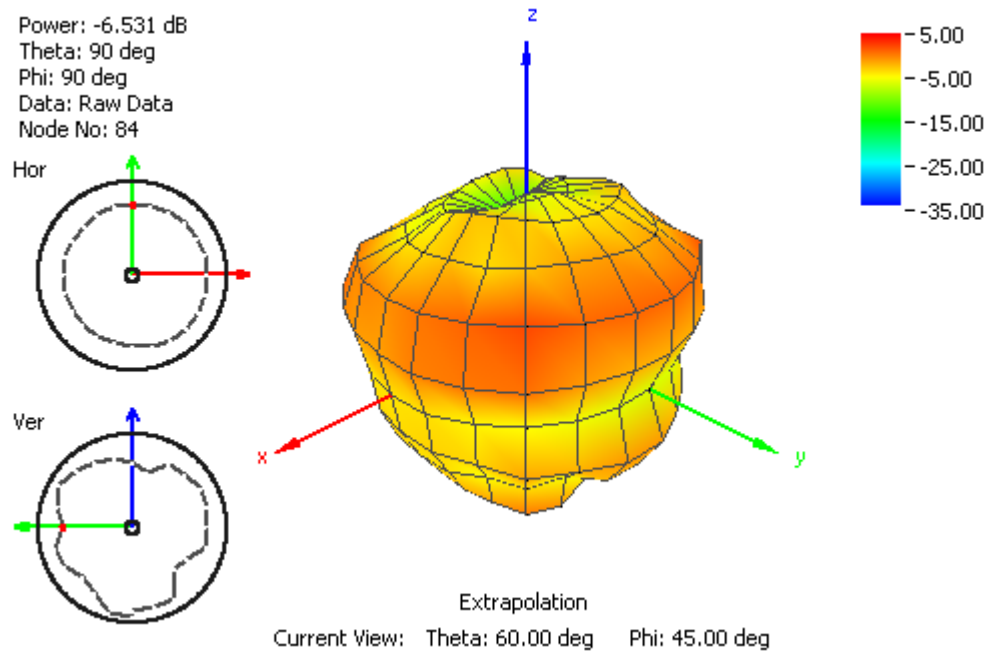
**Figure 22.** Radiation Pattern at 849 MHz of G30 Antenna on 30x30cm metal



**Figure 23.** Radiation Pattern at 915 MHz of G30 Antenna on 30x30cm metal .

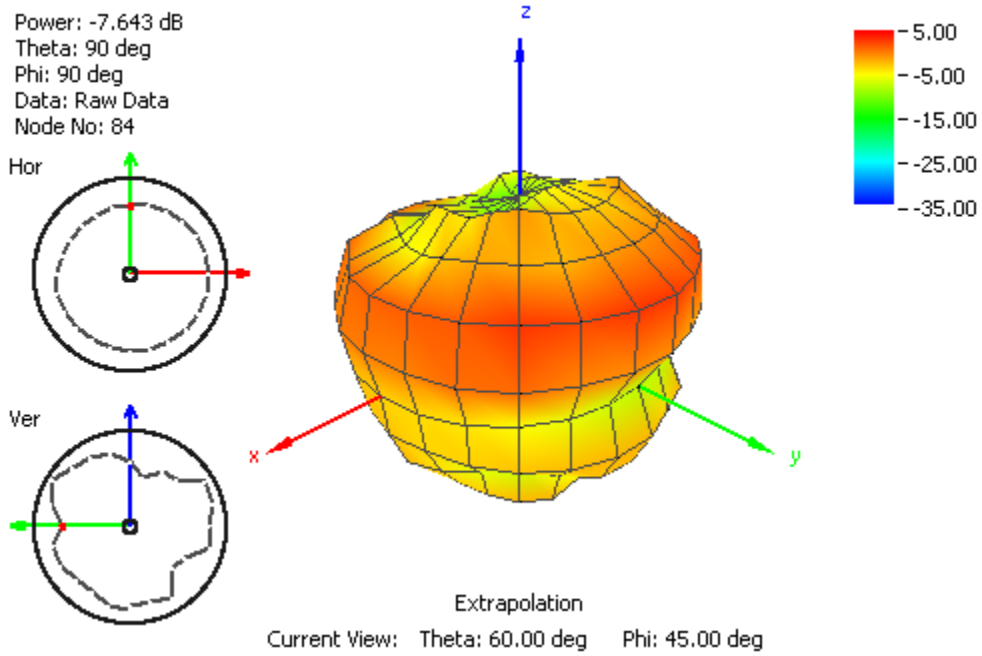


**Figure 24.** Radiation Pattern at 1710 MHz of G30 Antenna on 30x30cm metal.

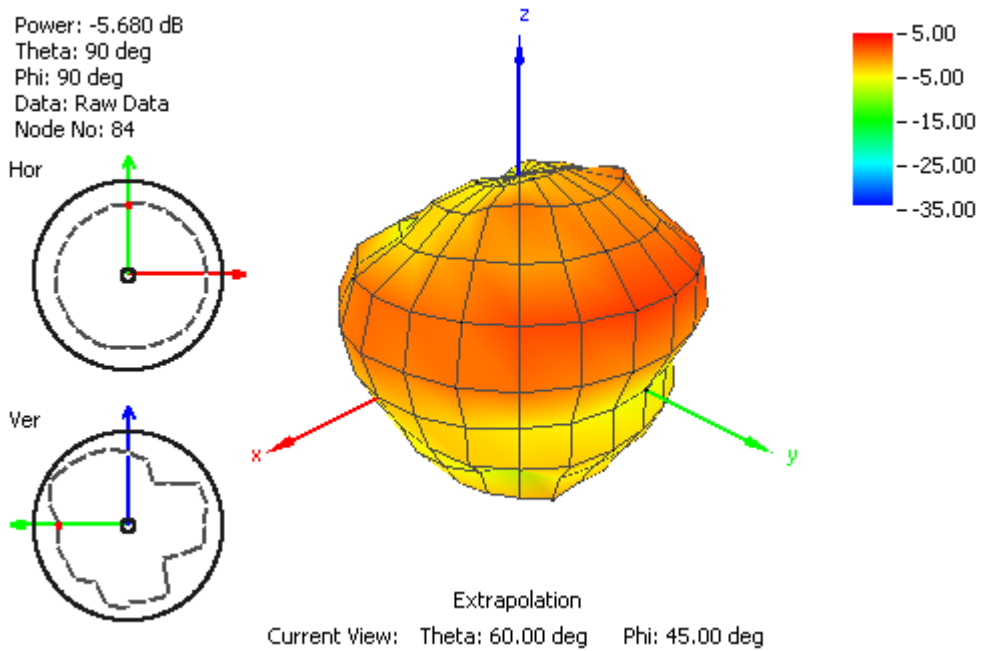


**Figure 25.** Radiation Pattern at 1805 MHz of G30 Antenna on 30x30cm metal.

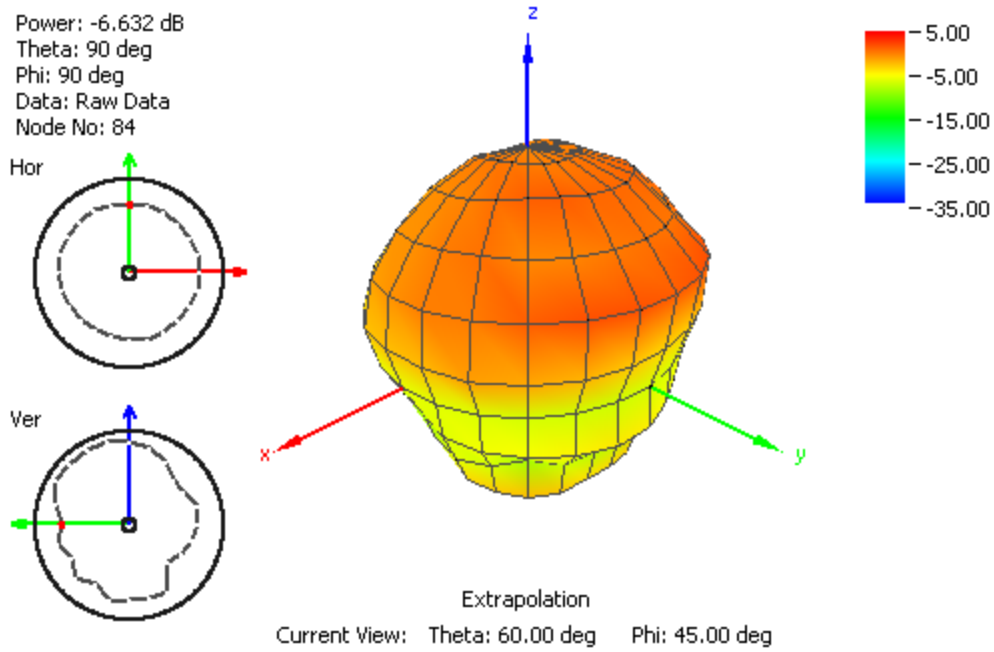




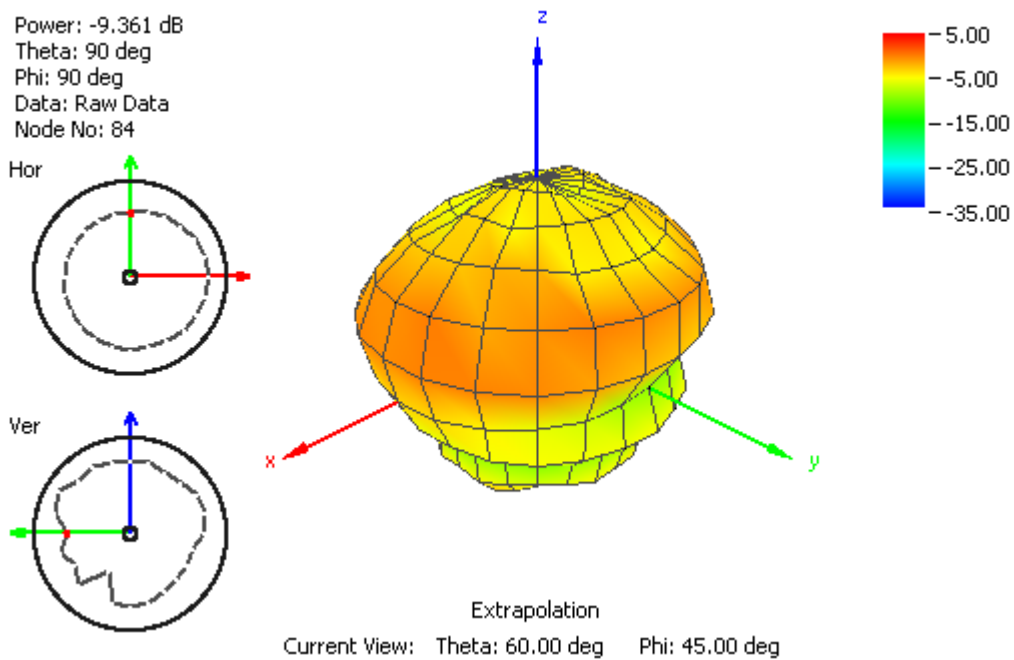
**Figure 26.** Radiation Pattern at 1910 MHz of G30 Antenna on 30x30cm metal.



**Figure 27.** Radiation Pattern at 1990 MHz of G30 Antenna on 30x30cm metal.

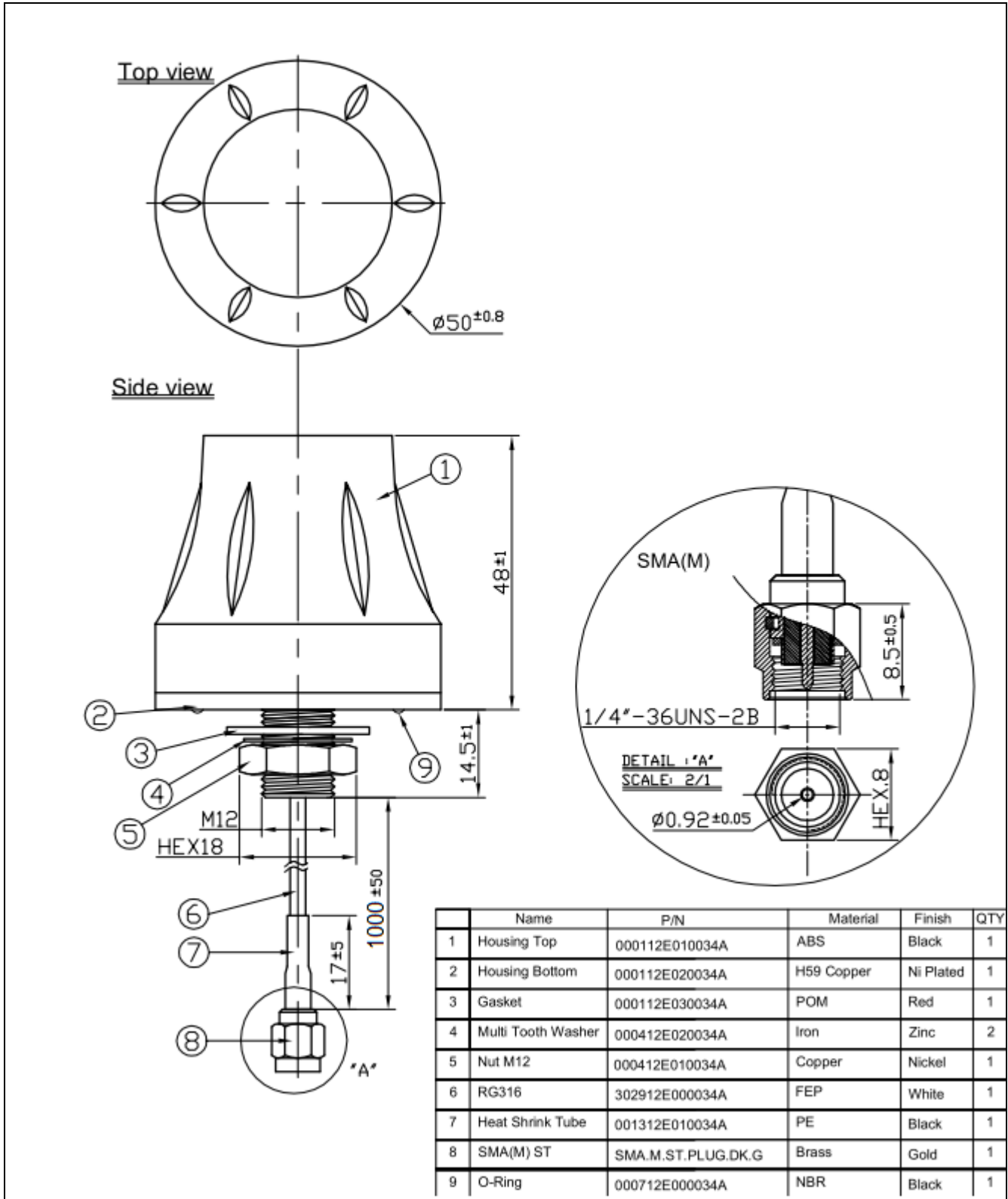


**Figure 28.** Radiation Pattern at 2110 MHz of G30 Antenna on 30x30cm metal.



**Figure 29.** Radiation Pattern at 2595 MHz of G30 Antenna on 30x30cm metal .

## 5. MECHANICAL DRAWING



**Figure 30.** Mechanical Drawing of the G30 Antenna