

## **SYSMAC One NSJ Series**

**NSJ5-TQ□□(B)-G5D, NSJ5-SQ□□(B)-G5D,  
NSJ8-TV□□(B)-G5D, NSJ10-TV□□(B)-G5D,  
NSJ12-TS□□(B)-G5D, NSJ5-TQ□□(B)-M3D,  
NSJ5-SQ□□(B)-M3D, NSJ8-TV□□(B)-M3D,  
NSJW-ETN21, NSJW-CLK21-V1, NSJW-IC101**

# **NSJ Controllers**

# **OPERATION MANUAL**

**OMRON**



# **SYSMAC One NSJ Series**

**NSJ5-TQ□□(B)-G5D, NSJ5-SQ□□(B)-G5D,  
NSJ8-TV□□(B)-G5D, NSJ10-TV□□(B)-G5D,  
NSJ12-TS□□(B)-G5D, NSJ5-TQ□□(B)-M3D,  
NSJ5-SQ□□(B)-M3D, NSJ8-TV□□(B)-M3D,  
NSJW-ETN21, NSJW-CLK21-V1, NSJW-IC101**

## **NSJ Controllers**

### **Operation Manual**



*Revised November 2010*



## Notice:

OMRON products are manufactured for use according to proper procedures by a qualified operator and only for the purposes described in this manual.

The following conventions are used to indicate and classify precautions in this manual. Always heed the information provided with them. Failure to heed precautions can result in injury to people or damage to property.

-  **DANGER** Indicates an imminently hazardous situation which, if not avoided, will result in death or serious injury. Additionally, there may be severe property damage.
-  **WARNING** Indicates a potentially hazardous situation which, if not avoided, could result in death or serious injury. Additionally, there may be severe property damage.
-  **Caution** Indicates a potentially hazardous situation which, if not avoided, may result in minor or moderate injury, or property damage.

## OMRON Product References

All OMRON products are capitalized in this manual. The word “Unit” is also capitalized when it refers to an OMRON product, regardless of whether or not it appears in the proper name of the product.

The abbreviation “Ch,” which appears in some displays and on some OMRON products, often means “word” and is abbreviated “Wd” in documentation in this sense.

The abbreviation “PLC” means Programmable Controller. “PC” is used, however, in some Programming Device displays to mean Programmable Controller.

## Visual Aids

The following headings appear in the left column of the manual to help you locate different types of information.

**Note** Indicates information of particular interest for efficient and convenient operation of the product.

- 1,2,3...** 1. Indicates lists of one sort or another, such as procedures, checklists, etc.

## © OMRON, 2005

All rights reserved. No part of this publication may be reproduced, stored in a retrieval system, or transmitted, in any form, or by any means, mechanical, electronic, photocopying, recording, or otherwise, without the prior written permission of OMRON.

No patent liability is assumed with respect to the use of the information contained herein. Moreover, because OMRON is constantly striving to improve its high-quality products, the information contained in this manual is subject to change without notice. Every precaution has been taken in the preparation of this manual. Nevertheless, OMRON assumes no responsibility for errors or omissions. Neither is any liability assumed for damages resulting from the use of the information contained in this publication.

# Unit Versions of NSJ-series NSJ Controllers

## Unit Versions

A “unit version” has been introduced to manage NSJ Controllers in the NSJ Series according to differences in functionality accompanying product upgrades.

### Notation of Unit Versions on Products

The unit version is given to above the lot number on the nameplate of the products for which unit versions are being managed, as shown below. The Controller Section of the NSJ Controllers has the same architecture as a CJ-series CJ1-H CPU Unit with unit version 3.0. The unit version of NSJ Controllers thus starts from unit version 3.0.

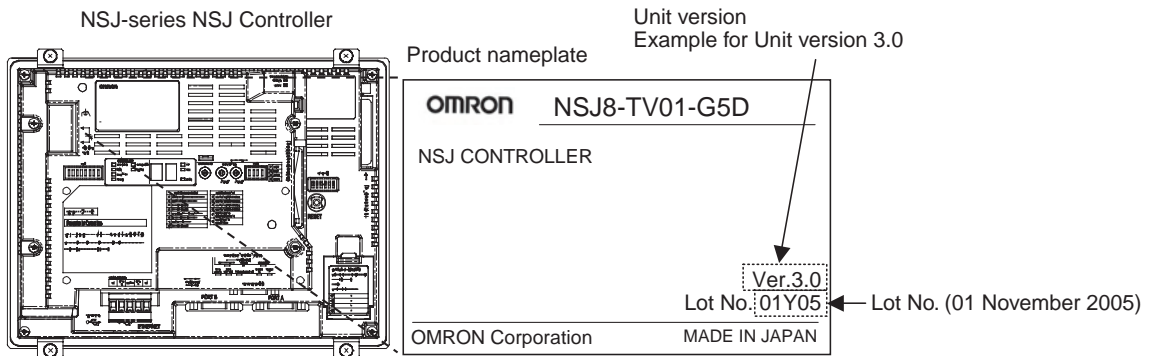

### Confirming Unit Versions with Support Software

The CX-Programmer can be used to confirm the unit version using one of the following methods.

- Using the **PLC Information**
- Using the **Unit Manufacturing Information** (This method can be used for Special I/O Units and CPU Bus Units as well.)

**Note** CX-Programmer version 6.1 or higher is required to go online with NSJ□-□□□□(B)-G5D Controllers. CX-Programmer version 7.0 or higher is required to go online with NSJ□-□□□□(B)-M3D Controllers.

### PLC Information

- If you know the device type and CPU type, select them in the *Change PLC* Dialog Box, go online, and select **PLC - Edit - Information** from the menus.
- If you don't know the device type and CPU type, but are connected directly to the Unit on a serial line, select **PLC - Auto Online** to go online, and then select **PLC - Edit - Information** from the menus.

In either case, the following *PLC Information* Dialog Box will be displayed.

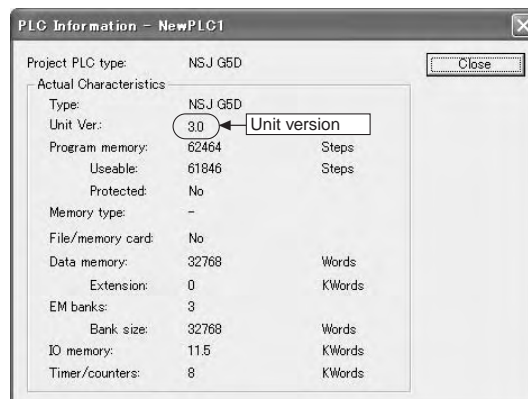

Use the above display to confirm the unit version of the NSJ Controller.

### **Unit Manufacturing Information**

In the IO Table Window, right-click and select ***Unit Manufacturing information - CPU Unit***.

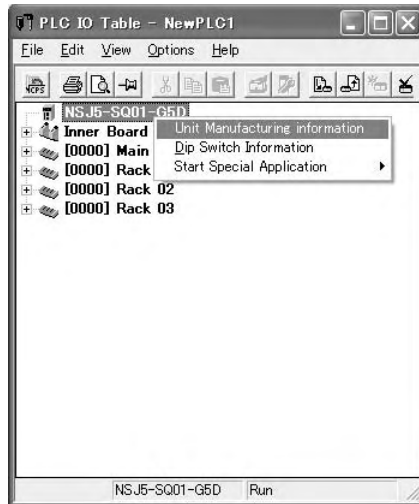

The following *Unit Manufacturing information* Dialog Box will be displayed.

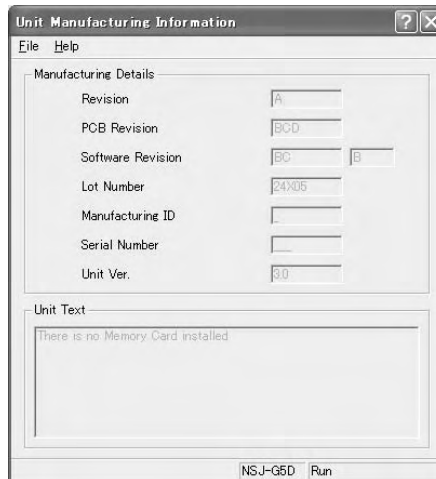

Use the above display to confirm the unit version of the NSJ Controller connected online.

### **System Menu on the Display Section**

The unit version can be confirmed using the System Menu on the Display Section.

**1,2,3...**

1. Simultaneously press two of the touch panel's four corners. The System Menu will be displayed.



2. Press the **Special Screen** Button. The following screen will be displayed.



3. Press the **System Version** Button. The unit version of the Controller Section and the system version of the Display Section will be displayed.

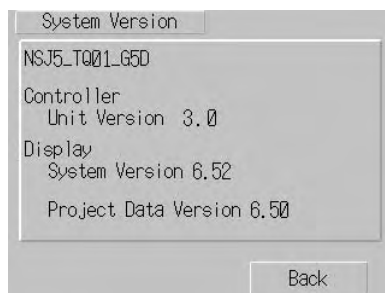



# TABLE OF CONTENTS

<b>PRECAUTIONS</b> .....	<b>xix</b>
1 Intended Audience .....	xx
2 General Precautions .....	xx
3 Safety Precautions .....	xx
4 Operating Environment Precautions .....	xxiii
5 Application Precautions .....	xxiii
6 Conformance to EC Directives .....	xxx
<b>SECTION 1</b>	
<b>Overview</b> .....	<b>1</b>
1-1 Overview .....	2
1-2 Differences between the NSJ Controller and Previous Products .....	20
1-3 Internal Operation of NSJ Controllers .....	22
1-4 Application Precautions .....	23
<b>SECTION 2</b>	
<b>Basic Operating Procedures</b> .....	<b>27</b>
2-1 Overall Operating Procedure .....	28
2-2 Installing the USB Driver .....	28
2-3 Operating Procedure for the Controller Section .....	35
2-4 Operating Procedure for the Display Section .....	36
<b>SECTION 3</b>	
<b>Specifications and System Configurations</b> .....	<b>39</b>
3-1 Specifications .....	40
3-2 System Configuration .....	64
<b>SECTION 4</b>	
<b>Nomenclature, Functions, and Dimensions</b> .....	<b>73</b>
4-1 Nomenclature and Functions .....	74
4-2 Dimensions .....	87
<b>SECTION 5</b>	
<b>Installation and Wiring</b> .....	<b>91</b>
5-1 Installation .....	92
5-2 Wiring .....	94
5-3 Mounting and Wiring Expansion Units .....	101
<b>SECTION 6</b>	
<b>PLC Setup and I/O Allocations</b> .....	<b>111</b>
6-1 PLC Setup .....	112
6-2 I/O Allocations .....	112
6-3 I/O Memory .....	112

# TABLE OF CONTENTS

## SECTION 7

<b>Operation of the Controller Section</b> .....	<b>119</b>
7-1 Power OFF Operation .....	120
7-2 Cycle Time .....	124

## SECTION 8

<b>System Menu Operations</b> .....	<b>125</b>
8-1 Operating Modes and System Menu .....	127
8-2 Initializing and Saving Data and Removing the Memory Card .....	132
8-3 PT Settings .....	142
8-4 Project Settings .....	150
8-5 Setting Passwords .....	154
8-6 Communications Settings .....	156
8-7 Screen Data Check .....	163
8-8 Special Screens .....	164
8-9 Hardware Check .....	175

## SECTION 9

<b>Ladder Monitor</b> .....	<b>177</b>
9-1 Using the Ladder Monitor .....	178
9-2 Starting the Ladder Monitor .....	178
9-3 Exiting Ladder Monitor .....	182

## SECTION 10

<b>Error Processing and Troubleshooting</b> .....	<b>183</b>
10-1 Troubleshooting and Maintenance .....	184
10-2 NSJ Troubleshooter Function .....	189

## SECTION 11

<b>Maintenance and Inspections</b> .....	<b>197</b>
11-1 Backup Function .....	198
11-2 Inspections and Cleaning .....	204
11-3 Maintenance and Replacement Methods .....	207

## Appendices

A Replacing the System Program .....	211
B System Memory List .....	217
C NSJ-series Controller Lot Numbers .....	221

<b>Revision History</b> .....	<b>223</b>
-------------------------------	------------

## About this Manual:

This manual describes the installation and operation of the NSJ-series NSJ Controllers and includes the sections described on the following page. The following NSJ Controllers are available:

NSJ5-TQ□□(B)-G5D

NSJ5-SQ□□(B)-G5D

NSJ8-TV□□(B)-G5D

NSJ10-TV□□(B)-G5D

NSJ12-TS□□(B)-G5D

NSJ5-TQ□□(B)-M3D

NSJ5-SQ□□(B)-M3D

NSJ8-TV□□(B)-M3D

Refer to *1-1-1 The NSJ Series* for basic information on the configuration of an NSJ Controller and Programming Software used for an NSJ Controller.

Please read this manual and all related manuals listed in the following tables and be sure you understand information provided before attempting to install or use an NSJ Controller.

### Controller Section

Manual		Cat. No.
CJ Series PLC Operation Manual		W393
CS/CJ Series PLC Programming Manual		W394
CS/CJ Series PLC Instructions Reference Manual		W474
CS/CJ Series PLC Communications Commands Reference Manual		W342
Built-in DeviceNet Section	CS/CJ Series DeviceNet Unit Operation Manual	W380
	DeviceNet Operation Manual	W267

### Display Section

Manual	Cat. No.
NS-Series Setup Manual	V083
NS-Series Programming Manual	V073

### Support Software

Manual	Cat. No.
CX-One Setup Manual	W463
CX-Programmer Operation Manual	W446
CX-Integrator Ver. 2.□ Operation Manual	W464
CX-Programmer Operation Manual: Function Blocks/Structured Text	W447
CX-Designer Operation Manual	V099
DeviceNet Configurator (Ver. 2.□) Operation Manual	W382

### Expansion Units

Manual	Cat. No.
Controller Link Unit Operation Manual	W309
CS/CJ Series Ethernet Unit Operation Manual: Ethernet Units Construction of Networks Operation Manual	W420
CS/CJ Series Ethernet Unit Operation Manual: Ethernet Units Construction of Applications Operation Manual	W421

## Related Manuals

Name	Cat. No.	Contents
SYSMAC One NSJ Series NSJ5-TQ□□(B)-G5D, NSJ5-SQ□□(B)-G5D, NSJ8-TV□□(B)-G5D, NSJ10-TV□□(B)-G5D, NSJ12-TS□□(B)-G5D, NSJ5-TQ□□(B)-M3D, NSJ5-SQ□□(B)-M3D, NSJ8-TV□□(B)-M3D, NSJW-ETN21, NSJW-CLK21-V1, NSJW-IC101 NSJ Controllers Operation Manual	W452 (this manual)	Provides an outline of, and describes the design, installation, maintenance, and other basic operations for the NSJ-series NSJ Controllers. Information is also included on features, system configuration, wiring, I/O memory allocations, and troubleshooting.  Use together with the CJ-series <i>Programmable Controllers Operation Manual (W393)</i> , CS/CJ-series <i>Programmable Controllers Programming Manual (W394)</i> , and <i>NS-Series Programmable Terminals Setup Manual (V083)</i> .
SYSMAC CJ Series CJ1G-CPU□□, CJ1M-CPU□□, CJ1G-CPU□□P, CJ1G/H-CPU□□H, CJ1H-CPU□□H-R Programmable Controllers Operation Manual	W393	Provides an outline of, and describes the design, installation, maintenance, and other basic operations for the CJ-series PLCs. Information is also included on features, system configuration, wiring, I/O memory allocations, and troubleshooting.  Use together with the CS/CJ-series <i>Programmable Controllers Programming Manual (W394)</i> .
SYSMAC CS/CJ Series CS1G/H-CPU□□-EV1, CS1G/H-CPU□□H, CS1D-CPU□□H, CS1D-CPU□□S, CJ1G-CPU□□, CJ1M-CPU□□, CJ1G-CPU□□P, CJ1G/H-CPU□□H, CJ1H-CPU□□H-R, NSJ□-□□□□(B)-G5D, NSJ□-□□□□(B)-M3D Programmable Controllers Programming Manual	W394	Describes programming, tasks, file memory, and other functions for the CS-series, CJ-series, and NSJ-series PLCs.  Use together with the <i>Programmable Controllers Operation Manual (W339 for CS-series PLCs and W393 for CJ-series PLCs)</i> .
SYSMAC CS/CJ Series CS1G/H-CPU□□-EV1, CS1G/H-CPU□□H, CS1D-CPU□□H, CS1D-CPU□□S, CJ1G-CPU□□, CJ1M-CPU□□, CJ1G-CPU□□P, CJ1G/H-CPU□□H, CJ1H-CPU□□H-R, NSJ□-□□□□(B)-G5D, NSJ□-□□□□(B)-M3D Programmable Controllers Instructions Reference Manual	W340	Describes the ladder diagram programming instructions supported by CS-series, CJ-series, and NSJ-series PLCs. Use together with the <i>Programmable Controllers Operation Manual (W339 for CS-series PLCs and W393 for CJ-series PLCs)</i> , and <i>Programmable Controllers Programming Manual (W394)</i> .
SYSMAC CS/CJ Series CS1G/H-CPU□□-EV1, CS1G/H-CPU□□H, CS1D-CPU□□H, CS1D-CPU□□S, CJ1G-CPU□□, CJ1M-CPU□□, CJ1G-CPU□□P, CJ1G/H-CPU□□H, CJ1H-CPU□□H-R, CP1H-X□□□□-□, CP1H-XA□□□□-□, CP1H-Y□□□□-□, NSJ□-□□□□(B)-G5D, NSJ□-□□□□(B)-M3D, CS1W-SCB21-V1/41-V1, CS1W-SCU21-V1, CJ1W-SCU21-V1/41-V1 Communications Commands Reference Manual	W342	Describes the C-series (Host Link) and FINS communications commands used with CS-series, CJ-series, CP-series, and NSJ-series PLCs.  This manual describes only communications commands addressed to the CPU Unit without regard to the communications path. (Communications are possible via the serial ports on the CPU Unit, ports on Serial Communications Boards/Units, Communications Units, etc.) Refer to the operation manual for the relevant Unit for commands addressed to Special I/O Units and CPU Bus Units.
NS Series NS5-SQ□□(B)-V1/V2, NS5-TQ□□(B)-V2, NS5-MQ□□(B)-V2, NS8-TV□□(B)-V1/V2, NS10-TV□□(B)-V1/V2, NS12-TS□□(B)-V1/V2 Programmable Terminals Setup Manual	V083	Provides an outline of, and describes the design, installation, maintenance, and other basic operations for the NS-series PTs. Information is also included on connecting to hosts and Programming Devices, and settings required for communications and PT operation.
NS Series NS5-SQ□□(B)-V1/V2, NS5-TQ□□(B)-V2, NS5-MQ□□(B)-V2, NS8-TV□□(B)-V1/V2, NS10-TV□□(B)-V1/V2, NS12-TS□□(B)-V1/V2 Programmable Terminals Programming Manual	V073	Describes the functions of NS-series PTs, including screen configurations, object functions, and host communications for the PT.

Name	Cat. No.	Contents
CS/CJ-series CS1W-DRM21(-V1) and CJ1W-DRM21 DeviceNet Units Operation Manual	W380	Provides information on the DeviceNet Section of an NSJ Controller, including descriptions of functions, settings required for operation, and maintenance.
DeviceNet Operation Manual	W267	Provides DeviceNet communications specifications and wiring methods.
DeviceNet DRT2 Series Slaves Operation Manual	W404	Describes DeviceNet DRT2-series Smart Slaves.
DeviceNet DRT1 Series Slaves Operation Manual	W347	Describes DeviceNet DRT1-series Smart Slaves.
DeviceNet MULTIPLE I/O TERMINAL Operation Manual	W348	Describes MULTIPLE I/O TERMINALS, which are one type of DeviceNet Slave.
CS/CJ Series CS1W-CLK23/CLK21-V1, CJ1W-CLK23/CLK21- V1, C200HW-CLK21, CVM1-CLK21, CQM1H- CLK21 (CS1W-RPT01/02/03 Repeater Units) Controller Link Units Operation Manual	W309	Describes the functions, settings required for operation, and maintenance of Controller Link Units. Controller Link Units are used to connect to a Controller Link Network.
CS1W-ETN21, CJ1W-ETN21 Ethernet Units Operation Manual Construction of Networks	W420	Provides information on operating and installing 100Base-TX Ethernet Units, including details on basic settings and FINS communications.  Refer to the <i>Communications Commands Reference Manual</i> (W342) for details on FINS commands that can be sent to CS-series and CJ-series CPU Units when using the FINS communications service.
CS1W-ETN21, CJ1W-ETN21 Ethernet Units Operation Manual Construction of Applications	W421	Provides information on constructing host applications for 100Base-TX Ethernet Units, including functions for sending/receiving mail, socket service, automatic clock adjustment, FTP server functions, and FINS communications.
SYSMAC WS02-CXPC□-V□ CX-Programmer Operation Manual	W446	Provides information on how to use the CX-Programmer, a Windows-based programming device.  Use together with the <i>Programmable Controllers Operation Manual</i> (W339 for CS-series PLCs and W393 for CJ-series PLCs), CS/CJ-series <i>Programmable Controllers Programming Manual</i> (W394) and the CS/CJ-series <i>Programmable Controllers Instructions Reference Manual</i> (W474) to perform programming.
CX-Integrator CS/CJ/CP/NSJ-series Network Configurator Operation Manual	W464	Describes CX-Integrator operating methods, e.g., for setting up and monitoring networks including data link settings, routing table settings, and Communications Unit settings.
CXONE-AL□□C-V4/AL□□D-V4 CX-One Setup Manual	W463	Describes the installation and overview of CX-One FA Integrated Tool Package.
SYSMAC WS02-CXPC□-V□ CX-Programmer Operation Manual: Function Blocks/Structured Text	W447	Describes specifications and operation methods related to function blocks. This information is required only when using function blocks.
SYSMAC CX-Designer NS-CXDC1-V□ Operation Manual	V099	Describes how to install and use the CX-Designer, including screen data creation methods, screen data transfer methods, and system settings.
DeviceNet Configurator Ver. 2.□ Operation Manual	W382	Describes the operating procedures of the DeviceNet Configurator.

This manual contains the following sections.

**Section 1** introduces the NSJ-series NSJ Controllers and describes differences between the NSJ Controllers and previous OMRON product. Application precautions are also provided.

**Section 2** provides the basic operating procedures required to use the NSJ-series NSJ Controller.

**Section 3** provides the specifications of the NSJ-series NSJ Controller and describes the system configurations in which it is used.

**Section 4** gives the names of the parts of the NSJ Controller, describes the function of each part, and provides NSJ Controller Dimensions.

**Section 5** describes how to install and wire the NSJ-series NSJ Controller.

**Section 6** section provides information on functionality added to the PLC Setup, I/O Allocations, and I/O Memory of the NSJ Controllers in comparison to the functionality of CJ-series PLCs. Refer to the *CJ Series PLC Operation Manual (W393)* for all information not given here.

**Section 7** describes the operation of the Controller Section.

**Section 8** describes the methods for operating the System Menu.

**Section 9** describes error processing and troubleshooting procedures needed to keep the NSJ Controller operating properly.

**Section 10** provides inspection and maintenance information.

The **Appendices** provide list of system memory in the Display Section and system program replacement procedures for the Display Section.

## ***Read and Understand this Manual***

Please read and understand this manual before using the product. Please consult your OMRON representative if you have any questions or comments.

## ***Warranty and Limitations of Liability***

### ***WARRANTY***

OMRON's exclusive warranty is that the products are free from defects in materials and workmanship for a period of one year (or other period if specified) from date of sale by OMRON.

OMRON MAKES NO WARRANTY OR REPRESENTATION, EXPRESS OR IMPLIED, REGARDING NON-INFRINGEMENT, MERCHANTABILITY, OR FITNESS FOR PARTICULAR PURPOSE OF THE PRODUCTS. ANY BUYER OR USER ACKNOWLEDGES THAT THE BUYER OR USER ALONE HAS DETERMINED THAT THE PRODUCTS WILL SUITABLY MEET THE REQUIREMENTS OF THEIR INTENDED USE. OMRON DISCLAIMS ALL OTHER WARRANTIES, EXPRESS OR IMPLIED.

### ***LIMITATIONS OF LIABILITY***

OMRON SHALL NOT BE RESPONSIBLE FOR SPECIAL, INDIRECT, OR CONSEQUENTIAL DAMAGES, LOSS OF PROFITS OR COMMERCIAL LOSS IN ANY WAY CONNECTED WITH THE PRODUCTS, WHETHER SUCH CLAIM IS BASED ON CONTRACT, WARRANTY, NEGLIGENCE, OR STRICT LIABILITY.

In no event shall the responsibility of OMRON for any act exceed the individual price of the product on which liability is asserted.

IN NO EVENT SHALL OMRON BE RESPONSIBLE FOR WARRANTY, REPAIR, OR OTHER CLAIMS REGARDING THE PRODUCTS UNLESS OMRON'S ANALYSIS CONFIRMS THAT THE PRODUCTS WERE PROPERLY HANDLED, STORED, INSTALLED, AND MAINTAINED AND NOT SUBJECT TO CONTAMINATION, ABUSE, MISUSE, OR INAPPROPRIATE MODIFICATION OR REPAIR.

## ***Application Considerations***

### ***SUITABILITY FOR USE***

OMRON shall not be responsible for conformity with any standards, codes, or regulations that apply to the combination of products in the customer's application or use of the products.

At the customer's request, OMRON will provide applicable third party certification documents identifying ratings and limitations of use that apply to the products. This information by itself is not sufficient for a complete determination of the suitability of the products in combination with the end product, machine, system, or other application or use.

The following are some examples of applications for which particular attention must be given. This is not intended to be an exhaustive list of all possible uses of the products, nor is it intended to imply that the uses listed may be suitable for the products:

- Outdoor use, uses involving potential chemical contamination or electrical interference, or conditions or uses not described in this manual.
- Nuclear energy control systems, combustion systems, railroad systems, aviation systems, medical equipment, amusement machines, vehicles, safety equipment, and installations subject to separate industry or government regulations.
- Systems, machines, and equipment that could present a risk to life or property.

Please know and observe all prohibitions of use applicable to the products.

**NEVER USE THE PRODUCTS FOR AN APPLICATION INVOLVING SERIOUS RISK TO LIFE OR PROPERTY WITHOUT ENSURING THAT THE SYSTEM AS A WHOLE HAS BEEN DESIGNED TO ADDRESS THE RISKS, AND THAT THE OMRON PRODUCTS ARE PROPERLY RATED AND INSTALLED FOR THE INTENDED USE WITHIN THE OVERALL EQUIPMENT OR SYSTEM.**

### ***PROGRAMMABLE PRODUCTS***

OMRON shall not be responsible for the user's programming of a programmable product, or any consequence thereof.



## **Disclaimers**

### ***CHANGE IN SPECIFICATIONS***

Product specifications and accessories may be changed at any time based on improvements and other reasons.

It is our practice to change model numbers when published ratings or features are changed, or when significant construction changes are made. However, some specifications of the products may be changed without any notice. When in doubt, special model numbers may be assigned to fix or establish key specifications for your application on your request. Please consult with your OMRON representative at any time to confirm actual specifications of purchased products.

### ***DIMENSIONS AND WEIGHTS***

Dimensions and weights are nominal and are not to be used for manufacturing purposes, even when tolerances are shown.

### ***PERFORMANCE DATA***

Performance data given in this manual is provided as a guide for the user in determining suitability and does not constitute a warranty. It may represent the result of OMRON's test conditions, and the users must correlate it to actual application requirements. Actual performance is subject to the OMRON Warranty and Limitations of Liability.

### ***ERRORS AND OMISSIONS***

The information in this manual has been carefully checked and is believed to be accurate; however, no responsibility is assumed for clerical, typographical, or proofreading errors, or omissions.



# PRECAUTIONS

This section provides general precautions for using the NSJ-series NSJ Controllers and related devices.

**The information contained in this section is important for the safe and reliable application of NSJ Controllers. You must read this section and understand the information contained before attempting to set up or operate an NSJ Controller.**

1	Intended Audience .....	xx
2	General Precautions .....	xx
3	Safety Precautions .....	xx
4	Operating Environment Precautions .....	xxiii
5	Application Precautions .....	xxiii
6	Conformance to EC Directives .....	xxx
6-1	Applicable Directives .....	xxx
6-2	Concepts .....	xxx
6-3	Conformance to EC Directives .....	xxx
6-4	Relay Output Noise Reduction Methods .....	xxx

## 1 Intended Audience

This manual is intended for the following personnel, who must also have knowledge of electrical systems (an electrical engineer or the equivalent).

- Personnel in charge of installing FA systems.
- Personnel in charge of designing FA systems.
- Personnel in charge of managing FA systems and facilities.

## 2 General Precautions

The user must operate the product according to the performance specifications described in the operation manuals.

Before using the product under conditions which are not described in the manual or applying the product to nuclear control systems, railroad systems, aviation systems, vehicles, combustion systems, medical equipment, amusement machines, safety equipment, and other systems, machines, and equipment that may have a serious influence on lives and property if used improperly, consult your OMRON representative.

Make sure that the ratings and performance characteristics of the product are sufficient for the systems, machines, and equipment, and be sure to provide the systems, machines, and equipment with double safety mechanisms.

This manual provides information for programming and operating the NSJ Controller. Be sure to read this manual before attempting to use the NSJ Controller and keep this manual close at hand for reference during operation.

 **WARNING** It is extremely important that the NSJ Controller be used for the specified purpose and under the specified conditions, especially in applications that can directly or indirectly affect human life. You must consult with your OMRON representative before applying an NSJ Controller to the above-mentioned applications.

## 3 Safety Precautions

 **WARNING** Do not attempt to take any Unit apart while the power is being supplied. Doing so may result in electric shock.







 **WARNING** Do not touch any of the terminals while the power is being supplied. Doing so may result in electric shock.









 **WARNING** Do not use the touch switch input functions of the Display Section for applications where danger to human life or serious property damage is possible, or for emergency switch applications.

 **WARNING** Provide safety measures in external circuits (i.e., not in the Programmable Controller), including the following items, to ensure safety in the system if an abnormality occurs due to malfunction of the NSJ Controller or another external factor affecting the NSJ Controller operation. Not doing so may result in serious accidents.

- Emergency stop circuits, interlock circuits, limit circuits, and similar safety measures must be provided in external control circuits.

- The NSJ Controller will turn OFF all outputs when its self-diagnosis function detects any error or when a severe failure alarm (FALS) instruction is executed. Unexpected operation, however, may still occur for errors in the I/O control section, errors in I/O memory, and other errors that cannot be detected by the self-diagnosis function. As a countermeasure for all such errors, external safety measures must be provided to ensure safety in the system.
- The NSJ Controller outputs may remain ON or OFF due to deposition or burning of the output relays or destruction of the output transistors. As a countermeasure for such problems, external safety measures must be provided to ensure safety in the system.

-  **WARNING** Do not attempt to disassemble, repair, or modify the NSJ Controller. Doing so may impair the safety functions.
-  **WARNING** Confirm safety before transferring data files stored in the file memory (Memory Card or EM file memory) to the I/O area (CIO) of the Controller Section using a Programming Device. Otherwise, the devices connected to Output Units may malfunction regardless of the operation mode of the Controller Section.
-  **WARNING** Fail-safe measures must be taken by the customer to ensure safety in the event of incorrect, missing, or abnormal signals caused by broken signal lines, momentary power interruptions, or other causes. Serious accidents may result from abnormal operation if proper measures are not provided.
-  **WARNING** The NSJ Controller refreshes I/O even when the program is stopped (i.e., even in PROGRAM mode). Confirm safety thoroughly in advance before changing the status of any part of memory allocated to Output Units, Special I/O Units, or CPU Bus Units. Any changes to the data allocated to any Unit may result in unexpected operation of the loads connected to the Unit. Any of the following operations may result in changes to memory status.
- Transferring I/O memory data to the Controller Section from a Programming Device.
  - Changing present values in memory from a Programming Device.
  - Force-setting/-resetting bits from a Programming Device.
  - Transferring I/O memory files from a Memory Card or EM file memory to the Controller Section.
  - Transferring I/O memory from a host computer or from another node on a network.
-  **WARNING** Always ensure that the personnel in charge confirm that installation, inspection, and maintenance were properly performed for the NSJ Controller. “Personnel in charge” refers to individuals qualified and responsible for ensuring safety during machine design, installation, operation, maintenance, and disposal.
-  **WARNING** Ensure that installation and post-installation checks are performed by personnel in charge who possess a thorough understanding of the machinery to be installed.

-  **Caution** Execute online edit only after confirming that no adverse effects will be caused by extending the cycle time. Otherwise, the input signals may not be readable.
-  **Caution** Confirm safety at the destination node before transferring a program to another node or changing contents of the I/O memory area. Doing either of these without confirming safety may result in injury.
-  **Caution** When setting Units using the IORD or IOWR instructions, check the operation of the ladder program and data completely before using them in actual operation. Incorrect settings may cause the Unit to stop operating or may result in unexpected operation of connected devices.
-  **Caution** The NSJ Controller automatically backs up the user program and parameter data to flash memory when these are written to the Controller Section. I/O memory (including the DM, EM, and HR Areas), however, is not written to flash memory. The DM, EM, and HR Areas can be held during power interruptions with a battery. If there is a battery error, the contents of these areas may not be accurate after a power interruption. If the contents of the DM, EM, and HR Areas are used to control external outputs, prevent inappropriate outputs from being made whenever the Battery Error Flag (A40204) is ON. Areas such as the DM, EM, and HR Areas, the contents of which can be held during power interrupts, is backed up by a battery. If a battery error occurs, the contents of the areas that are set to be held may not be accurate even though a memory error will not occur to stop operation. If necessary for the safety of the system, take appropriate measures in the ladder program whenever the Battery Error Flag (A40204) turns ON, such as resetting the data in these areas.
-  **Caution** When installing the NSJ Controller on the door of a control panel or any other moving object, be sure that all cables are long enough so that excessive force is not applied to cables and connectors.
-  **Caution** Tighten the power supply terminal block screws to the torque specified in this manual. Loose screws may result in fire or malfunction.
-  **Caution** Wire the polarity of the power supply correctly when using a DC power supply. Reversing the polarity may cause abnormal operation.
-  **Caution** Do not touch a Power Supply Unit while power is being supplied or immediately after turning OFF the power supply. The Unit may be hot and may cause burns.
-  **Caution** When connecting a Programming Device or other personal computer to a NSJ Controller to which a non-insulated Power Supply Unit (e.g., CJ1W-PD022) is mounted, either ground the 0 V side of the external power supply or do not ground the external power supply at all ground. A short-circuit will occur in the external power supply if incorrect grounding methods are used. Never ground the 24 V side, as shown below.

Wiring in Which the 24-V Power Supply Will Short

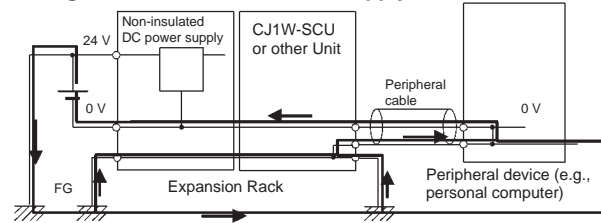

## 4 Operating Environment Precautions

**⚠ Caution** Do not operate the control system in the following locations:

- Locations subject to drastic temperature changes or condensation.
- Locations subject to temperatures or humidity outside the range specified in the specifications.
- Locations subject to high humidity and the possibility of condensation.
- Locations subject to exposure to chemicals.
- Locations subject to exposure to oil.
- Locations subject to corrosive or flammable gases.
- Locations subject to shock or vibration.
- Locations outdoors subject to direct rain or wind.
- Locations subject to strong ultraviolet light.
- Locations subject to excessive dust and dirt.
- Locations subject to direct sunlight.

**⚠ Caution** Take appropriate and sufficient countermeasures when installing systems in the following locations:

- Locations subject to static electricity or other forms of noise.
- Locations subject to strong electromagnetic fields.
- Locations close to power lines.
- Locations subject to possible exposure to radioactivity.

**⚠ Caution** The operating environment of the NSJ Controller can have a large effect on the longevity and reliability of the system. Improper operating environments can lead to malfunction, failure, and other unforeseeable problems with the NSJ Controller. Be sure that the operating environment is within the specified conditions at installation and remains within the specified conditions during the life of the system.

## 5 Application Precautions

**⚠ WARNING** Always heed these precautions. Failure to abide by the following precautions could lead to serious or possibly fatal injury.

- Always connect to a ground of 100  $\Omega$  or less when installing the Units. Not connecting to a ground of 100  $\Omega$  or less may result in electric shock.

- Always turn OFF the power supply to the NSJ Controller before attempting any of the following. Not turning OFF the power supply may result in malfunction or electric shock.
  - Mounting or dismounting Power Supply Units, I/O Units, or any other Units.
  - Assembling the Units or Racks.
  - Setting DIP switches or rotary switches.
  - Connecting cables or wiring the system.
  - Connecting or disconnecting the connectors.

 **Caution** Failure to abide by the following precautions could lead to faulty operation of the NSJ Controller or the system, or could damage the NSJ Controller. Always heed these precautions.

- When opening the package, check the external appearance of the NSJ Controller to be sure that it has not been damaged. Also, shake the NSJ Controller gently to check for abnormal sounds.
- Do not drop the product or subject it to excessive vibration or shock.
- Install external breakers and take other safety measures against short-circuiting in external wiring.
- Take appropriate measures to ensure that the specified power with the rated voltage and frequency is supplied. Be particularly careful in places where the power supply is unstable.
- Do not apply a force greater than 100 N on the terminal block when tightening the terminals.
- Do not perform withstand voltage tests on the NSJ Controller.
- The allowable thickness of the panel for mounting is between 1.6 and 4.8 mm. Secure the mounting bracket with a uniform tightening torque of between 0.5 and 0.6 N to keep the NSJ Controller waterproof and dust-proof. The front sheet may become distorted if the tightening torque is more than the specified limit or not uniform. Always use a panel that is clean, undistorted, and strong enough to adequately withstand mounting the NSJ Controller.
- Do not allow metal particles to enter the NSJ Controller while work is being performed on the panel.
- Do not connect an AC power supply to the power terminals on the NSJ Controller.
- Use a DC power supply with minimal voltage fluctuation that provides a stable output even if the power supply input is interrupted for 10 ms. The DC power supply must also have reinforced or double insulation.  
Rated power supply voltage: 24 VDC (Allowable range: 20.4 to 27.6 VDC)  
Capacity for NSJ12, NSJ10, or NSJ8: 30 W min  
Capacity for NSJ5-TQ: 22 W min.  
Capacity for NSJ5-SQ: 21 W min.
- Connect power to the power terminal block using twisted-pair power lines with a cross-sectional area of at least 2 mm<sup>2</sup> and always using M3.5 crimp terminals. The correct tightening torque for the terminal block is 0.8 N·m.
- To conform to the Low Voltage Directive in the EC Directives, use a power supply with reinforced insulation for Expansion Racks.



- Do not pull on the cables or bend the cables beyond their natural limit. Doing either of these may break the cables.
- Do not place objects on top of the cables or other wiring lines. Doing so may break the cables.
- Before touching a Unit, be sure to first touch a grounded metallic object in order to discharge any static build-up. Not doing so may result in malfunction or damage.
- When transporting or storing circuit boards, cover them in antistatic material to protect LSIs, ICs, and other components from static electricity and maintain the proper storage temperature.
- Do not touch circuit boards or the components mounted to them with your bare hands. There are sharp leads and other parts on the boards that may cause injury if handled improperly.
- Mount Units only after checking terminal blocks and connectors completely.
- Be sure that the terminal blocks, expansion cables, and other items with locking devices are properly locked into place. Improper locking may result in malfunction.
- Be sure that all the terminal screws, and cable connector screws are tightened to the torque specified in the relevant manuals. Incorrect tightening torque may result in malfunction.
- Wire all connections correctly.
- Use crimp terminals for wiring. Do not connect bare stranded wires directly to terminals. Connection of bare stranded wires may result in burning. Do not connect more than two crimp terminals to the same terminal.
- Check switch settings, the contents of the DM Area, and other preparations before starting operation. Starting operation without the proper settings or data may result in an unexpected operation.
- Always use the power supply voltages specified in this operation manuals. An incorrect voltage may result in malfunction or burning.
- Double-check all wiring and switch settings before turning ON the power supply.
- When assembling and wiring connectors, check all pin numbers carefully and wire them correctly.
- Properly ground the NSJ Controller to prevent malfunction due to noise.
- Perform all wiring according to the methods given in this and other relative manuals.
- Always use the special cables listed in this manual or make cables according to manual specifications. Using commercially available cables may damage the external devices or the NSJ Controller.
- Confirm the safety of the system before turning ON or OFF the power supply or before pressing the reset button.
- Always reset the power supply after changing switch settings.
- Leave the label attached to an I/O Unit when wiring it. Removing the label may result in malfunction if foreign matter enters the Unit.
- Remove the label after the completion of wiring to ensure proper heat dissipation. Leaving the label attached may result in malfunction.
- Do not apply voltages to the Input Units in excess of the rated input voltage. Excess voltages may result in burning.

- Do not apply voltages or connect loads to the Output Units in excess of the maximum switching capacity. Excess voltage or loads may result in burning.
- The user program and parameter area data is backed up in the internal flash memory. The BKUP indicator will light on the NSJ Controller when the backup operation is in progress. Do not turn OFF the power supply to the NSJ Controller when the BKUP indicator is lit. The data will not be backed up if power is turned OFF.
- Start actual system application only after sufficiently checking screen data, macros, and the operation of the program in the Controller Section.
- When replacing the NSJ Controller, resume operation only after transferring to the new Display Section and Controller Section all data required for resuming operation. Not doing so may result in an unexpected operation.
- When using a program for which errors in the Display Section would affect control operations, monitor for errors in the status area of the Display Section and make sure that operation functions on the safe side if an error occurs.
- Do not perform the following operations while the uploading or downloading screen data or system programs. The screen data or system program may be corrupted.
  - Turning OFF the power supply to the NSJ Controller
  - Pressing the reset switch on the Display Section
- Confirm that no adverse effect will occur in the system before attempting any of the following. Not doing so may result in unexpected operation.
  - Changing the operating mode of the NSJ Controller (including the setting of the startup operating mode).
  - Force-setting/force-resetting any bit in memory.
  - Changing the present value of any word or any set value in memory.
- Use the CX-Programmer (programming software that runs on Windows) if you need to program more than one task.
- Turning the power supply ON or OFF may cause the overall system to stop. Always follow approved procedures when turning the power supply ON or OFF.
- When creating an AUTOEXEC.IOM file from a Programming Device (CX-Programmer) to automatically transfer data at startup, set the first write address to D20000 and be sure that the size of data written does not exceed the size of the DM Area. When the data file is read from the Memory Card at startup, data will be written to the Controller Section starting at D20000 even if another address was set when the AUTOEXEC.IOM file was created. Also, if the DM Area is exceeded (which is possible when the CX-Programmer is used), the remaining data will be written to the EM Area.
- Always turn ON power to the NSJ Controller before turning ON power to the control system. If the NSJ Controller power supply is turned ON after the control power supply, temporary errors may result in control system signals because the output terminals on DC Output Units and other Units will momentarily turn ON when power is turned ON to the NSJ Controller.
- Fail-safe measures must be taken by the customer external to the NSJ Controller to ensure safety in the event that outputs from Output Units remain ON as a result of internal circuit failures, which can occur in relays, transistors, and other elements.

- If the I/O Hold Bit is turned ON, the outputs from the NSJ Controller will not be turned OFF and will maintain their previous status when the NSJ Controller is switched from RUN or MONITOR mode to PROGRAM mode. Make sure that the external loads will not produce dangerous conditions when this occurs. (When operation stops for a fatal error, including those produced with the FALS(007) instruction, all outputs from Output Unit will be turned OFF and only the internal output status will be maintained.)
- The contents of the DM, EM, and HR Areas in the Controller Section are backed up by a Battery. If the Battery voltage drops, this data may be lost. Provide countermeasures in the program using the Battery Error Flag (A40204) to re-initialize data or take other actions if the Battery voltage drops.
- Do not perform the following operations while a Memory Card is being accessed. In the worst case, the Memory Card may be rendered unusable.
  - Turning OFF the power supply to the NSJ Controller
  - Pressing the reset switch on the Display Section
- Always following the specified procedure when removing the Memory Card. In the worst case, the Memory Card may be rendered unusable if it is removed while being accessed.
- Unexpected operation may result if inappropriate data link tables or parameters are set. Even if appropriate data link tables and parameters have been set, confirm that the controlled system will not be adversely affected before starting or stopping data links.
- CPU Bus Units will be restarted when routing tables are transferred from a Programming Device to the NSJ Controller. Restarting these Units is required to read and enable the new routing tables. Confirm that the system will not be adversely affected before allowing the CPU Bus Units to be reset.
- Do not connect an USB connector to any device that is not applicable.
- Before connecting an USB connector to a device, make sure that the device is free of damage.
- Commercially available and recommended USB Hubs do not have the same specifications as the NSJ Controller. Normal operation may not be possible in environments subject to noise or static electricity. When using USB Hubs, be sure to provide sufficient measures to prevent noise and static electricity, or install in a location that is not subject to noise or static electricity.
- Do not press the touch switch with a force greater than 30 N.
- Confirm the safety of the system before pressing touch switches.
- Do not accidentally press touch switches when the backlight is not lit or when the display does not appear.
- Signals from the touch switches may not be input if the switches are pressed consecutively at high speed. Confirm each input before proceeding to the next one.
- Before initializing screen data, confirm that existing data is backed up at the NS-Designer.
- When changing the password with the system menu, do not reset or turn OFF the power supply until writing is finished (i.e., until the Write Button returns to its original condition). It may become impossible to manipulate screens if the password is not set correctly.

- When using the device monitor, confirm the safety of the system before performing the following operations.
  - Changing monitor data
  - Changing operation modes
  - Forced setting or resetting
  - Changing present values or set values
- To ensure safety, always set upper and lower limits when using the numeral input function.
- Do not use benzene, paint thinner, or other volatile solvents, and do not use chemically treated cloths.
- use chemically treated cloths.
- When connecting pin 6 (+5 V power supply line) of serial port A or B (RS-232C ports on the Display Section) to any external device, make sure that the current capacity of the connected device is 250 mA max.
- Do not connect pin 6 (+5 V power supply line) of serial port C (RS-232C ports on the Controller Section) to any external device except the CJ1W-CIF11 RS-422A Adapter or NT-AL001 RS-232C/RS-422A Adapter. Doing so may damage the external device or NSJ Controller.
- When replacing parts, be sure to confirm that the rating of a new part is correct. Not doing so may result in malfunction or burning.
- When backing up the system, use the correct Memory Card slot, as shown in the following table.

Purpose	Slot
Backing up the Controller Section	MC (CONTROLLER)
Backing up the Display Section	MC (DISPLAY)

- A DeviceNet multidrop connector cannot be connected to serial port B on the NSJ5-□□□□-□□□□. Do not use it. DeviceNet multidrop connectors cannot be used with the NSJ8/10/12-□□□□-□□□□.
- Use only an insulated power source for DeviceNet communications.
- Always tighten the connector screws when connecting communications connectors.
- Observe the following precautions when using the built-in DeviceNet Section.
  - Enable the scan list to before operating the system.
  - When adding a new node to the network, make sure that the baud rate is the same as other nodes.
- Use specified communications cables.
- Do not extend connection distances beyond the ranges given in the specifications.
- Do not use a screwdriver or any other tool to operate the touch switches.
- Do not short the battery terminals or charge, disassemble, heat, or incinerate the battery. Do not subject the battery to strong shocks. Doing any of these may result in leakage, rupture, heat generation, or ignition of the battery. Dispose of any battery that has been dropped on the floor or otherwise subjected to excessive shock. Batteries that have been subjected to shock may leak if they are used.
- UL standards required that batteries be replaced only by experienced technicians. Do not allow unqualified persons to replace batteries.

- The backlight used in the NSJ Controller contain mercury. Dispose of the NSJ Controller and any Batteries that are no longer required according to all local laws and ordinances.



廢電池請回收

- When mounting a Battery, be sure that the correct model is being used.
- The life of the Battery will be shortened if the NSJ Controller is left for a period of time without power supplied and then a Battery is mounted without supplying power.
- To ensure that memory is not corrupted, always turn ON the power supply to the NSJ Controller for at least 5 minutes before replacing the Battery and then complete replacing the Battery within 5 minutes after turning OFF the power supply.
- The following precautions apply to Power Supply Units with Replacement Notification.
  - When the LED display on the front of the Power Supply Unit starts to alternately display “0.0” and “A02” or the alarm output automatically turns OFF, replace the Power Supply Unit within 6 months.
  - Separate the alarm output cables from power lines and high-voltage lines.
  - Do not apply a voltage or connect a load to the alarm output that exceeds the rated voltage or load.
  - Maintain an ambient storage temperature of  $-20$  to  $30^{\circ}\text{C}$  and humidity of 25% to 70% when storing the product for longer than 3 months to keep the replacement notification function in optimum working condition.
  - Always use the standard installation method. A nonstandard installation will decrease heat dissipation, delay the replacement notification signal, and may degrade or damage the internal elements.
- Design the system so that the power supply capacity of the Power Supply Unit is not exceeded.
- Do not touch the terminals on the Power Supply Unit immediately after turning OFF the power supply. Electric shock may occur due to the residual voltage.
- Periodically check the installation conditions in applications where the NSJ Controller is subject to contact with oil or water.
- Waterproof and oil-proof performance may be lost if the front sheet is peeling or cracked. Do not use the NSJ Controller if the front sheet is peeling or cracked.
- Depending on the application environment, the rubber packing may deteriorate, shrink, or harden. Inspect and replace it periodically.

## 6 Conformance to EC Directives

### 6-1 Applicable Directives

- EMC Directives

### 6-2 Concepts

#### **EMC Directives**

OMRON devices conform to the related EMC standards so that they can be more easily built into other devices or the overall machine. The actual products have been checked for conformity to EMC standards (see the following note). Whether the products conform to the standards in the system used by the customer, however, must be checked by the customer.

EMC-related performance of the OMRON devices that comply with EC Directives will vary depending on the configuration, wiring, and other conditions of the equipment or control panel on which the OMRON devices are installed. The customer must, therefore, perform the final check to confirm that devices and the overall machine conform to EMC standards.

**Note** Applicable EMC (Electromagnetic Compatibility) standards are as follows:  
EN 61131-2

### 6-3 Conformance to EC Directives

The NSJ Controllers comply with EC Directives. To ensure that the machine or device in which the NSJ Controller is used complies with EC Directives, the NSJ Controller must be installed as follows:

- 1,2,3...**
1. The NSJ Controller must be installed within a control panel.
  2. You must use reinforced insulation or double insulation for the DC power supplies used for the NSJ Controller, Expansion Racks, and I/O power supplies. The DC power supply for the NSJ Controller and Expansion Racks must have an output hold time of 10 ms min.
  3. NSJ Controllers also conform to EMI Standard (EN61131-2). Radiated emission characteristics (10-m regulations) may vary depending on the configuration of the control panel used, other devices connected to the control panel, wiring, and other conditions. You must therefore confirm that the overall machine or equipment complies with EC Directives.
  4. This is a class A product. In residential areas it may cause radio interference, in which case the user may be required to take adequate measures to reduce interference.

### 6-4 Relay Output Noise Reduction Methods

The NSJ Controllers conforms to the Common Emission Standards (EN61000-6-4) of the EMC Directives. However, noise generated by relay output switching may not satisfy these Standards. In such a case, a noise filter must be connected to the load side or other appropriate countermeasures must be provided external to the NSJ Controller.

Countermeasures taken to satisfy the standards vary depending on the devices on the load side, wiring, configuration of machines, etc. Following are examples of countermeasures for reducing the generated noise.

#### Countermeasures

(Refer to EN61000-6-4 for more details.)

Countermeasures are not required if the frequency of load switching for the whole system with the NSJ Controller included is less than 5 times per minute.

Countermeasures are required if the frequency of load switching for the whole system with the NSJ Controller included is more than 5 times per minute.

**Countermeasure Examples**

When switching an inductive load, connect an surge protector, diodes, etc., in parallel with the load or contact as shown below.

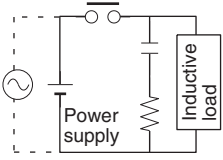
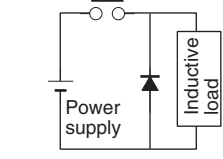
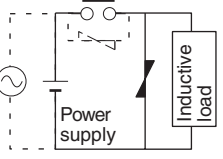
Circuit	Current		Characteristic	Required element
	AC	DC		
<p>CR method</p> 	Yes	Yes	<p>If the load is a relay or solenoid, there is a time lag between the moment the circuit is opened and the moment the load is reset.</p> <p>If the supply voltage is 24 or 48 V, insert the surge protector in parallel with the load. If the supply voltage is 100 to 200 V, insert the surge protector between the contacts.</p>	<p>The capacitance of the capacitor must be 1 to 0.5 <math>\mu\text{F}</math> per contact current of 1 A and resistance of the resistor must be 0.5 to 1 <math>\Omega</math> per contact voltage of 1 V. These values, however, vary with the load and the characteristics of the relay. Decide these values from experiments, and take into consideration that the capacitance suppresses spark discharge when the contacts are separated and the resistance limits the current that flows into the load when the circuit is closed again.</p> <p>The dielectric strength of the capacitor must be 200 to 300 V. If the circuit is an AC circuit, use a capacitor with no polarity.</p>
<p>Diode method</p> 	No	Yes	<p>The diode connected in parallel with the load changes energy accumulated by the coil into a current, which then flows into the coil so that the current will be converted into Joule heat by the resistance of the inductive load.</p> <p>This time lag, between the moment the circuit is opened and the moment the load is reset, caused by this method is longer than that caused by the CR method.</p>	<p>The reversed dielectric strength value of the diode must be at least 10 times as large as the circuit voltage value. The forward current of the diode must be the same as or larger than the load current.</p> <p>The reversed dielectric strength value of the diode may be two to three times larger than the supply voltage if the surge protector is applied to electronic circuits with low circuit voltages.</p>
<p>Varistor method</p> 	Yes	Yes	<p>The varistor method prevents the imposition of high voltage between the contacts by using the constant voltage characteristic of the varistor. There is time lag between the moment the circuit is opened and the moment the load is reset.</p> <p>If the supply voltage is 24 or 48 V, insert the varistor in parallel with the load. If the supply voltage is 100 to 200 V, insert the varistor between the contacts.</p>	---

When switching a load with a high inrush current such as an incandescent lamp, suppress the inrush current as shown below.

**Countermeasure 1**

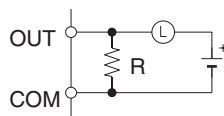

Providing a dark current of approx. one-third of the rated value through an incandescent lamp

**Countermeasure 2**

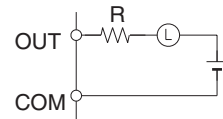

Providing a limiting resistor



# SECTION 1

## Overview

This section introduces the NSJ-series NSJ Controllers and describes differences between the NSJ Controllers and previous OMRON products. Application precautions are also provided.

1-1	Overview . . . . .	2
1-1-1	The NSJ Series . . . . .	2
1-1-2	Features . . . . .	4
1-1-3	Types of NSJ Controllers . . . . .	5
1-1-4	Differences in Display Section System Versions . . . . .	6
1-1-5	System Configuration . . . . .	8
1-1-6	Connecting a Programming Device . . . . .	11
1-2	Differences between the NSJ Controller and Previous Products . . . . .	20
1-2-1	Differences between Controller Sections and CJ1G-CPU45H for All Models of NSJ Controllers . . . . .	20
1-2-2	Differences between NSJ□-□□□□(B)-M3D Controller Sections and CJ1G-CPU45H . . . . .	21
1-2-3	Differences between Display Section and NS-series PT . . . . .	21
1-2-4	Comparison of Ethernet Functionality for NSJ Controllers . . . . .	22
1-3	Internal Operation of NSJ Controllers . . . . .	22
1-4	Application Precautions . . . . .	23

## 1-1 Overview

### 1-1-1 The NSJ Series

NSJ-series NSJ Controllers are Programmable Controllers (PLCs) with user interface display panels called Programmable Terminals (PTs) attached to them. They combine the high-speed, high-capacity, multifunctional capabilities of a PLC with the interfacing capabilities of a PT.

The PLC portion of an NSJ Controller is called the Controller Section and uses the same architecture as a CJ-series CJ1G-CPU45H CPU Unit with unit version 3.0. DeviceNet master functionality is also built-in as a standard feature. Refer to the *CJ Series Operation Manual* (Cat. No. W393) for a description of the features. Refer to *1-2 Differences between the NSJ Controller and Previous Products* for a list of the differences between the Controller Section of a NSJ Controller and a CJ1G-CPU45H CPU Unit with unit version 3.0.

The PT portion of an NSJ Controller is called the Display Section and uses the same architecture as an NS-V2-series PT. Refer to *1-2 Differences between the NSJ Controller and Previous Products* for a list of the differences between the Display Section of a NSJ Controller and an NS-V2-series PT.

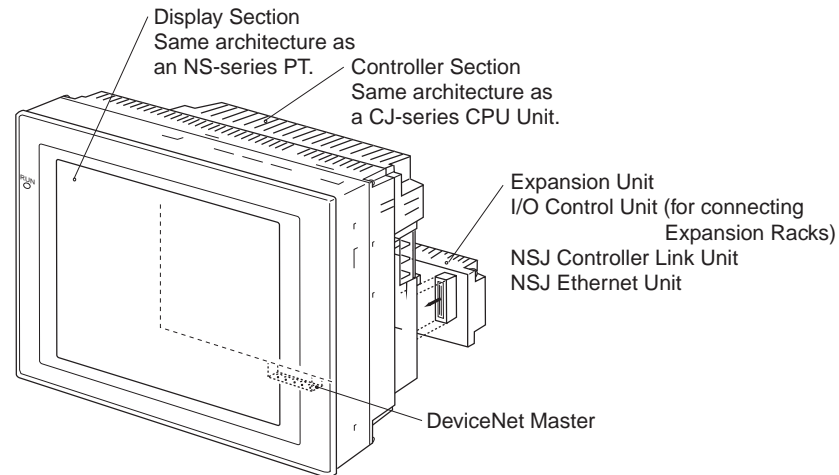

**Note** The Controller Section and Display Section form a one-piece unit and cannot be separated from each other.

One of the following NSJ Expansion Units can be used with an NSJ Controller: NSJ Controller Link Unit, NSJ Ethernet Unit, or NSJ I/O Control Unit. Using an NSJ I/O Control Unit enables connecting CJ-series Expansion Racks.

**Basic NSJ Control Configuration**

An NSJ Controller consists of a Controller Section that is equivalent to a CJ-series CJ1G-CPU45H CPU Unit with unit version 3.0 and a Display Section that is equivalent to an NS-V2-series PT. The three NSJ Expansion Unit (NSJ Controller Link Unit, NSJ Ethernet Unit, and NSJ I/O Control Unit) are equivalent to the CJ-series Units listed in the following table. Refer to *1-2 Differences between the NSJ Controller and Previous Products* for a list of the differences between the Controller Section and Display Section of an NSJ Controller and the original PLC and PT.

Name	Model	Configuration					
		Controller Section		Display Section			
		Equivalent Unit	Functional unit version	Equivalent PT	Functional version		
NSJ Controller	NSJ5-TQ□□(B)-G5D NSJ5-SQ□□(B)-G5D	CJ1G-CPU45H (See note.)	Ver. 3.0	NS5-TQ□□(B)-V2 NS5-SQ□□(B)-V2	Ver. 6.5 or Ver. 6.6		
	NSJ8-TV□□(B)-G5D			NS8-TV□□(B)-V2			
	NSJ10-TV□□(B)-G5D			NS10-TV□□(B)-V2			
	NSJ12-TS□□(B)-G5D			NS12-TS□□(B)-V2			
	NSJ5-TQ□□(B)-M3D (See note.) NSJ5-SQ□□(B)-M3D (See note.) NSJ8-TV□□(B)-M3D (See note.)					NS5-TQ□□(B)-V2 NS5-SQ□□(B)-V2	Ver. 6.6
					NS8-TV□□(B)-V2		
	Built-in DeviceNet Section			---	CJ1W-DRM21	---	---
NSJ Controller Link Unit	NSJW-CLK21-V1	CJ1W-CLK21-V1	Ver. 1.2	---	---		
NSJ Ethernet Unit	NSJW-ETN21	CJ1W-ETN21	Ver. 1.4	---	---		
NSJ I/O Control Unit	NSJW-IC101	CJ1W-IC101	---	---	---		

**Note** The NSJ□-□□□□(B)-M3D Controller Section differs from the CJ-series CJ1G-CPU45H for the items listed in the following table.

Item		CJ-series CJ1G-CPU45H	NSJ□-□□□□(B)-M3D Controller Section
I/O capacity		1,280 points	640 points
Program capacity		60 Ksteps	20 Ksteps
Expansion Racks		3 max.	1 max.
EM Area		32 Kwords x 3 banks E0_00000 to E2_32767	None
Function blocks	Definitions	1,024 max.	128 max.
	Instances	2,048 max.	256 max.
Flash memory	FB program memory	1,024 Kbytes	256 Kbytes
	Variable tables	128 Kbytes	64 Kbytes

**Programming Software**

Use CX-One version 1.1 or higher for NSJ□-□□□□(B)-G5D Controllers, and use CX-One version 2.0 or higher for NSJ□-□□□□(B)-M3D Controllers.

**Controller Section**

Use CX-One version 1.1 or higher (CX-Programmer version 6.1 or higher and CX-Integrator) for the Controller Section in an NSJ□-□□□□(B)-G5D Controller, and use CX-One version 2.0 or higher (CX-Programmer version 7.0 or higher and CX-Integrator) for the Controller Section in an NSJ□-□□□□(B)-M3D Controller.

Set the *Device type* in the CX-Programmer to *NSJ*. Use the following procedure from the CX-Programmer.

- 1,2,3... 1. Select **File - New**.
2. Select *NSJ* in the Change PLC Dialog Box.

### Display Section

Use CX-One version 1.1 or higher (CX-Designer version 1.0 or higher) for the Display Section in an NSJ□-□□□□(B)-G5D Controller, and use CX-One version 2.0 or higher (CX-Designer version 2.0 or higher) for the Display Section in an NSJ□-□□□□(B)-M3D Controller.

Set the *PT model* in the CX-Designer to *NSJ*. Use the following procedure from the CX-Designer.

- 1,2,3... 1. Select **File - New Project**.
2. Select *NSJ* for the *Model* in the New Project Dialog Box.
3. A host called "Controller" is used for the Controller Section in the NSJ Controller. When setting addresses in the Controller Section, set the host to "Controller."

## 1-1-2 Features

### Complete Setup, Programming, and Monitoring Support with the CX-One

The CX-One Unified Development Environment provides all required functions, including those to program, debug, and operate the Controller Section, create and transfer screens to the Display Section, and set up DeviceNet communications. (Use CX-One version 2.0 or higher for the NSJ□-□□□□(B)-M3D and CX-One version 1.1 or higher for all other NSJ Controllers.)

### Access All Functionality through a Single Port

The CX-One (including CX-Programmer, CX-Integrator, and CX-Designer) connects to either the USB port or one of the RS-232C ports (i.e., ports A and B on the Display Section). All operations, such as programming the Controller Section and transferring screens to the Display Section, can be achieved through a single port. (Use CX-One version 2.0 or higher for the NSJ□-□□□□(B)-M3D and CX-One version 1.1 or higher for all other NSJ Controllers.)

### High-speed Controller Section

Instruction execution times (basic instructions from 0.04 μs and special instructions from 0.06 μs) and other high-speed processing capabilities are equivalent to those of a CJ1G-CPU45H CPU Unit with unit version 3.0.

### 32,768-color (Maximum) Displays

The high-quality display capabilities of the Display Section are equivalent to those of an NS-V2 PT.

### Reduced Labor Requirements

When using a separate PLC and PT, the PLC and PT must be connected with a cable and communications settings must be made in each. With the NSJ Controllers, all of these connection and setting procedures are not required, saving valuable installation and setup time.

### Reduced Space Requirements

NSJ Controllers can use DeviceNet for I/O to achieve a depth of only 73.3 mm for the NSJ8/NSJ10/NSJ12 and only 79 mm for the NSJ5 (without an Expansion Unit). No additional space is required for the PLC to reduce space requirements for installation.

### I/O Control via DeviceNet

The NSJ Controllers include master functionality for the DeviceNet open field network. I/O can thus be controlled using a DeviceNet network within the restrictions of the network communications cycle.

### Mount an Expansion Unit

One Expansion Unit can be connected to add CJ-series Expansion Racks, a Controller Link port, or an Ethernet port.

- Connect CJ-series Expansion Racks to use any required CJ-series Units. An NSJ I/O Control Unit can be mounted to the back of the NSJ Controller to connect up to three CJ-series Expansion Racks with a total of up to 30 CJ-series Units (10 Units per Rack). Any of the CJ-series Basic I/O Units, Special I/O Units, and CPU Bus Units can be mounted to the CJ-series Expansion Racks.
- If an NSJ I/O Control Unit is not mounted, either an NSJ Controller Link Unit can be mounted to add a Controller Link port or an NSJ Ethernet Unit can be mounted to add an Ethernet port. This enables either connecting to a host via Ethernet or connecting to the pier-to-pier Controller Link network. Seamless communications are possible to integrate information with the host or with other production lines.

**Ladder Monitoring Function (Display Section System Version 6.6 or Later, Except for NSJ5)**

Using the ladder monitoring function makes it possible to monitor the execution status of programs in the Controller Section or in other PLCs without having to use a Programming Device, such as a CX-Programmer or Programming Console.

**Special NSJ Troubleshooting Features**

Special screens are provided on the Display Section that enable monitoring the Controller Section or DeviceNet master functionality of the NSJ Controller. Error information and countermeasures can be displayed. The alarm monitoring function of the Display Section can also be used to automatically switch to the special screens when an alarm occurs.

**Easy Backup of Controller Section Using Display Section Menus**

The System Menu of the Display Section can be used to back up Controller Section data onto a Memory Card.

### 1-1-3 Types of NSJ Controllers

There are two types of NSJ Controllers, as follows:

- NSJ□-□□□□(B)-G5D
- NSJ□-□□□□(B)-M3D

**Differences between Types of Controllers**

The following points are different in the Controller Sections of NSJ□-□□□□(B)-G5D and NSJ□-□□□□(B)-M3D Controllers. (The Display Sections are identical.)

Model		NSJ□-□□□□(B)-G5D Controller Section	NSJ□-□□□□(B)-M3D Controller Section
<b>I/O capacity</b>		1,280 points	640 points
<b>Program capacity</b>		60 Ksteps	20 Ksteps
<b>Data memory capacity</b>		128 Kwords (DM Area: 32 Kwords, EM Area: 32 Kwords x 3 banks)	32 Kwords (DM Area: 32 Kwords, EM Area: None)
<b>LD instruction processing speed</b>		0.04 μs (Same as CJ1G-CPU45H)	
<b>Expansion Racks</b>		3 max.	1 max.
<b>Function blocks</b>	<b>Definitions</b>	1,024 max.	128 max.
	<b>Instances</b>	2,048 max.	256 max.
<b>Built-in file memory</b>	<b>FB program memory</b>	1,024 Kbytes	256 Kbytes
	<b>Variable tables</b>	128 Kbytes	64 Kbytes

### Selecting the Device Type in the CX-Programmer Change PLC Dialog Box

Using the CX-Programmer, either of the following can be selected as the *Device type* in the Change PLC Dialog Box.

NSJ Controller type	Selected device type	Selected CPU type
NSJ□-□□□□(B)-G5D	NSJ	G5D
NSJ□-□□□□(B)-M3D		M3D

### 1-1-4 Differences in Display Section System Versions

Item	Previous versions	New version
CX-Designer	Version 1.0 (NS-CXDC1-V1)	Version 2.0 (NS-CXDC1-V2)
System version of Display Section	Version 6.5	Version 6.6
Integrated Simulation	The only function available was simulated testing of Display Section screen operations on a personal computer.	Using a personal computer, a virtual Display Section can be connected to a virtual Controller Section (CX-Simulator) to simulate NSJ Controller operation. This makes it possible to reduce the total time involved in debugging.
Symbol programming without addresses	Symbol names, addresses, and comments were entered in symbol tables. Then the required symbols were selected from the symbol tables when creating screens.	Symbol names and comments can be input for symbol tables with no addresses. This allows screens to be created using symbol names without inputting addresses. Entering symbols in screen designs without addresses makes it possible to reduce the total time involved in design.
Data security	The following two types of data transfers are possible between CX-Designer (running on a personal computer) and the Display Section: <ul style="list-style-type: none"> <li>• Data transfers with the Display Section.</li> <li>• With data transfers using a Memory Card, data can be uploaded and downloaded by any user.</li> </ul>	A password can now be set for creating data. When data with a set password is transferred to the Display Section, the password is then required in order to upload the data. This prevents users who do not know the password from obtaining that data from the Display Section. In addition, a password can be required to transfer data to the Display Section. This prevents data from being accidentally overwritten.
User security	Any of five levels of passwords could be set for each functional object. A dialog box asking for the password was displayed each time an attempt was made to use a functional object for which a password had been set, and the object could not be used unless the password was input.	With the new version, once a user inputs the password to use a functional object for which a password has been set, a password does not have to be input again as long as the user continues using only functional objects for which the same or lower level passwords have been set. (Functional objects with a higher-level passwords cannot be manipulated. A warning message will be displayed if an attempt is made.) This makes it possible to create applications that permit only the necessary operations by users who have entered a password, and thus helps prevent faulty operations.
Consecutive line drawing	Not available.	Data in memory is treated as X and Y coordinates, and straight lines are drawn between the applicable coordinates to create consecutive line drawing. This makes it possible to handle applications involving the drawing of various graphics in two-dimensional space that could not be drawn using the existing graph components.

Item	Previous versions	New version
Improvements in broken-line graph	Number of monitor points: 256 max.	<ul style="list-style-type: none"> <li>• Number of monitor points: 1,000 max.</li> <li>• Batch reading</li> <li>• Graph overwriting</li> <li>• Indirect specification of starting display position</li> <li>• Indirect specification of displaying/hiding graph lines</li> <li>• Indirect specification of displaying/hiding scale lines</li> </ul>
Ladder Monitor	Not supported.	Built-in (except for NSJ5 Controllers)
Symbol table transfers when transferring screen data	Symbol tables set using the CX-Designer could be managed only by the CX-Designer, and symbol data was lost when data was uploaded from the NS-series Display Section.	When screen data is downloaded from the CX-Designer, the symbol tables are downloaded together with it. Likewise, when screen data is uploaded, the symbol tables are uploaded too.
Holding log and alarm information when transferring screen data	All of the log and alarm information in the Display Section was initialized when screen data was downloaded.	It is now possible to select whether log and alarm information is to be initialized when screen data is downloaded.
PLC data trace reading	Not supported. (This was a function of the CX-Programmer.)	Trace results from data traces (which is a Controller Section function) can now be read by the Display Section and displayed in time chart format. (CSV files cannot be saved.) This makes it possible to isolate the causes of errors that occur on-site without the CX-Programmer.
Addition of European fonts	With the built-in raster fonts in the Display Sections, Russian and Greek characters were full-width and not all characters were available.	All Russian and Greek characters are now available, and all characters are half-width.
Japanese file names	Two-byte characters could not be used for project file names.	Two-byte characters can now be used for project file names.
SAP (Smart Active Parts)	---	SAP has been added for the EJ1 Modular Temperature Controller, G3ZA Multi-channel Power Controller, and Troubleshooters.
Automatically using symbol names and I/O comments for labels and alarm messages	---	The symbol names and I/O comments for the set communications addresses can be automatically used as the alarm messages and label text strings for functional objects.

### 1-1-5 System Configuration

#### Configuration with No Expansion Unit

A Programming Device (e.g., CX-Programmer or CX-Designer) can be connected to the USB port or serial port A or B, which are on the Display Section. The serial ports on the Display Section have the same functionality as the ports on an NS-series PT. They can also be connected to a barcode reader, temperature controller, or other external device when a Programming Device is not connected.

Serial port C, which is on the Controller Section, has the same functionality as the RS-232C port on a CJ1-H CPU Unit with unit version 3.0. It can be connected using Host Link, NT Link, no-protocol, or Serial Gateway (CompoWay/F devices) protocols. Device master functionality is provided as a standard feature, so I/O can be controlled using a DeviceNet network within the restrictions of the network communications cycle.

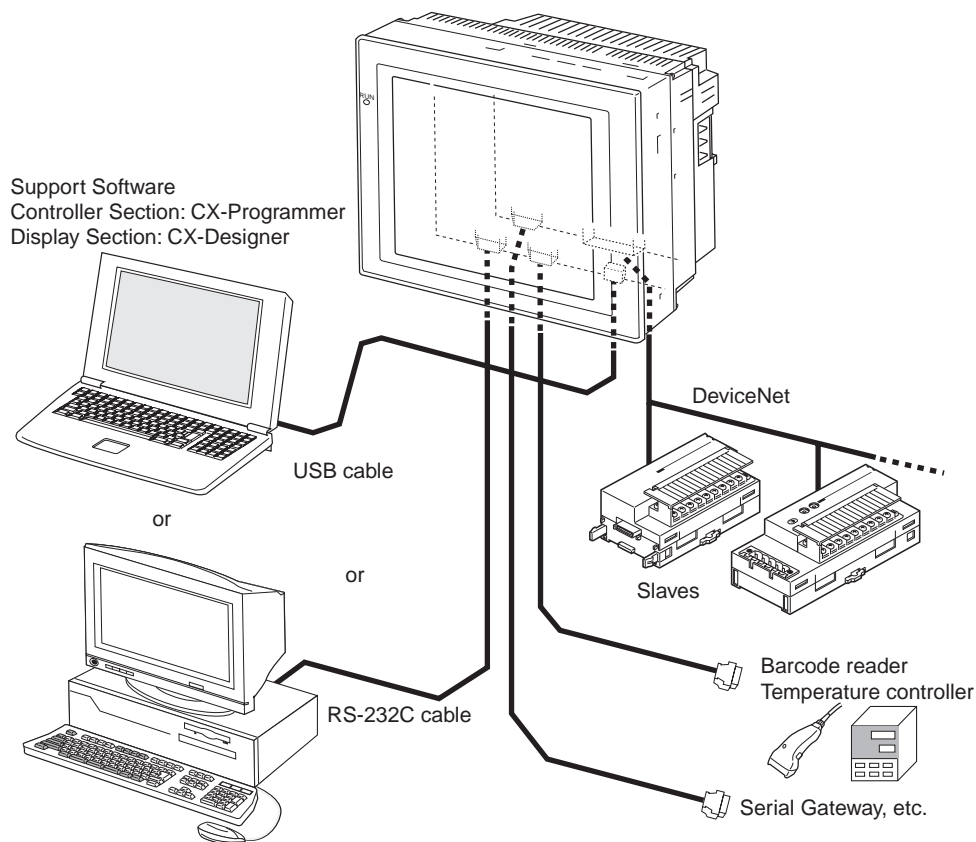



**Mounting an Expansion Unit**

One Expansion Unit can be mounted to add CJ-series Expansion Racks, a Controller Link port, or an Ethernet port.

**Mounting an NSJ I/O Control Unit**

For the NSJ□-□□□□(B)-M3D, an NSJ I/O Control Unit can be used to connect up to three CJ-series Expansion Racks with a total of up to 30 CJ-series Units (10 Units per Rack). For all other NSJ Controllers, an NSJ I/O Control Unit can be used to connect one CJ-series Expansion Rack with up to 10 CJ-series Units.

Any of the CJ-series Basic I/O Units, Special I/O Units, and CPU Bus Units can be mounted to an Expansion Rack.

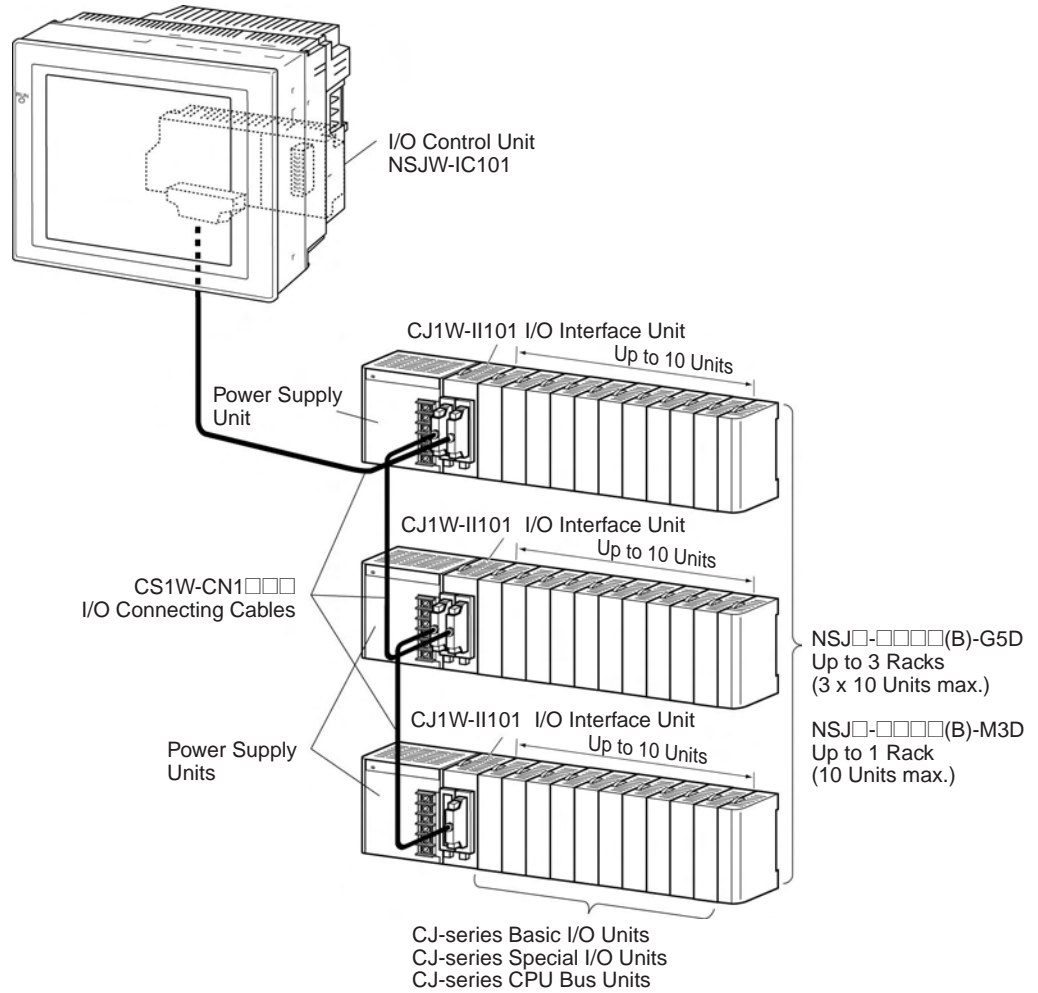

**Mounting an NSJ Controller Link Unit**

Mounting an NSJ Controller Link Unit enables data links (program-free shared data) between the NSJ Controller, other NSJ Controllers, and PLCs, as well as as-needed message communications (FINS) between the NSJ Controller, other NSJ Controllers, and PLCs. Data links and message communications are also possible with computers connected to the Controller Link network.

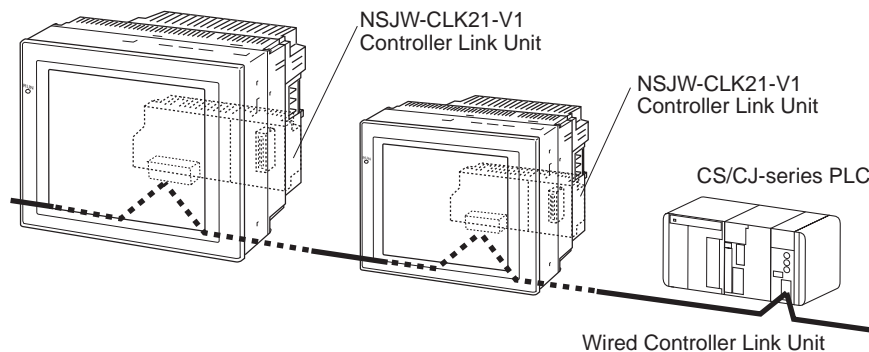

**Mounting an NSJ Ethernet Unit**

Mounting an NSJ Ethernet Unit enables as-needed message communications (FINS) between the NSJ Controller, host computers, other NSJ Controllers, and PLCs connected to the Ethernet network. FTP commands can be sent from host computers on the Ethernet network to read and write files in Memory Cards in the Controller Section of the NSJ Controller (see note). UDP or TCP protocol can be used to send and receive any required data to provide greater compatibility with higher-layer information networks.

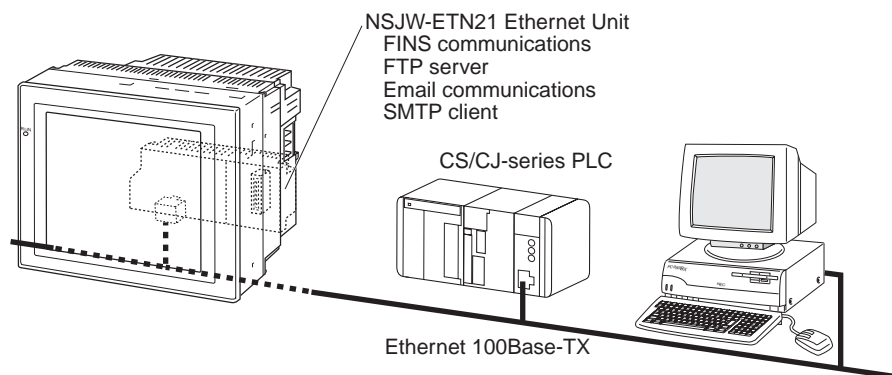

**Note** Only a Memory Card mounted in the Controller Section can be read with FTP command when an NSJ Ethernet Unit is mounted. Files in the Memory Card in the Display Section (e.g., screen data files) cannot be accessed.

## 1-1-6 Connecting a Programming Device

### Basic Connection

#### Connecting to the USB Port

Connect the Programming Device to the USB slave connector on the Display Section using an off-the-shelf USB Cable. The connector on the Display Unit is a type B USB connector.

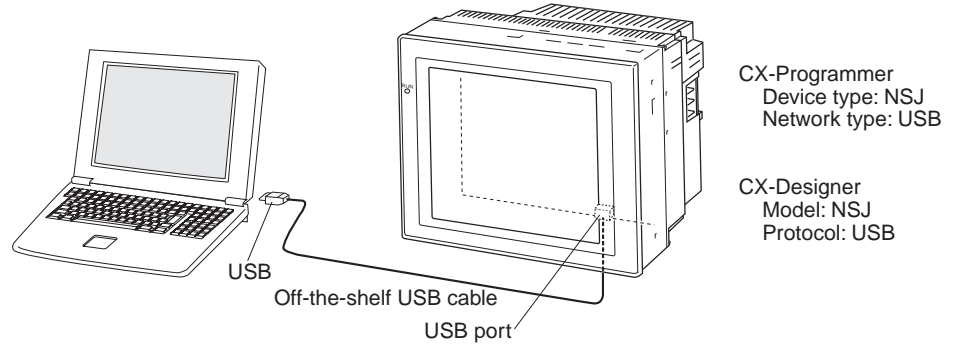

#### Connecting to an RS-232C Port (Serial Port A or B)

Connect the Programming Device to serial port A or B using an XW2Z-200S-CV/500S-CV RS-232C Cable.

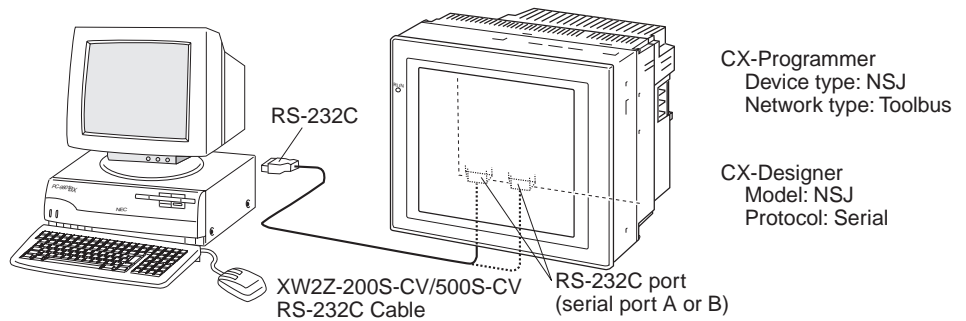

#### Connecting to the Ethernet Port

Connect the Programming Device to the Ethernet connector on an NSJ Controller with a built-in Ethernet port.

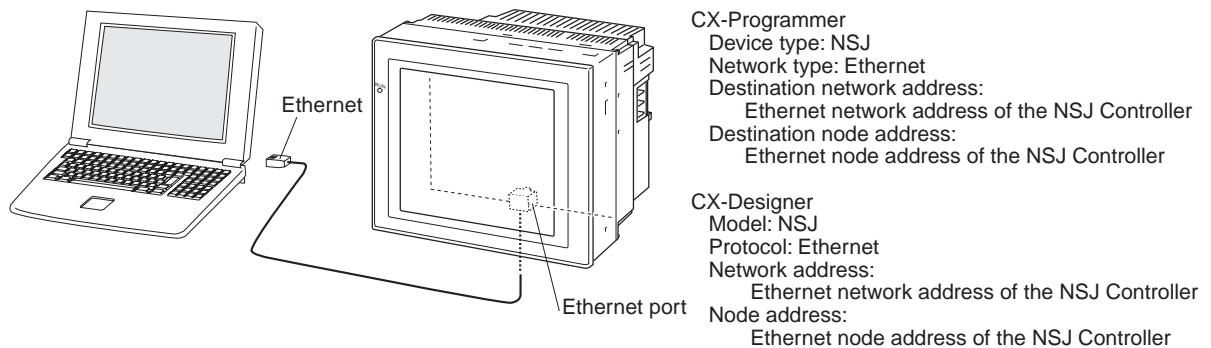

### System Configuration and Programming Device Connection

This section describes Programming Device connections in relation to the type of system configuration in which the NSJ Controller is being used.

Only a built-in Ethernet port can be used to transfer screens to the Display Section of an NSJ Controller using a network connection. Network transfers of screen data are not possible through an NSJ Ethernet Unit or NSJ Controller Link Unit.

#### NSJ Controllers without an Expansion Unit

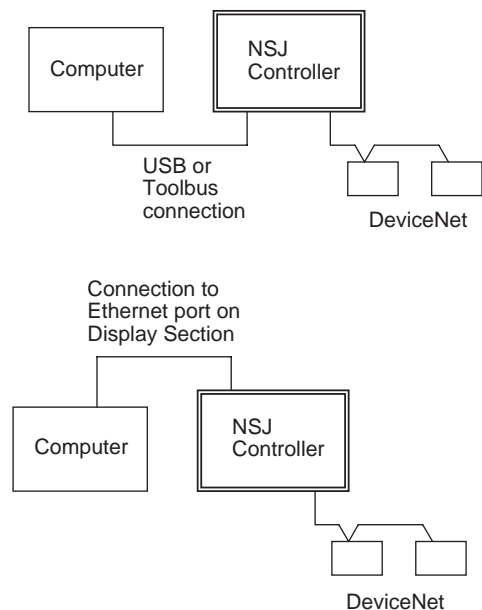

The Ethernet network address and node address must be set in the communications setting on the Comm Tab Page of the System Menu to enable using the built-in Ethernet port of the NSJ Controller.

Programming Device connection	Operating the Controller Section (setting I/O tables, transferring programs, monitoring, etc.)	Setting up DeviceNet	Transferring screens to the Display Section
USB	Supported	Supported	Supported
Toolbus (serial port A or B)	Supported	Supported	Supported
Built-in Ethernet port	Supported	Supported	Supported

**Note** If communications become impossible between the Controller Section and Display Section, CX-Programmer version 7.0 or later can be connected to serial port C to read Controller Section data. Transferring screens to the Display Section and network operations, however, are not possible while connected to serial port C. Normally keep the CX-Programmer connected to the USB or peripheral port (serial port A or B) or to the built-in Ethernet port.

**NSJ Controllers Connected via the Built-in Ethernet Port on the Display Section**

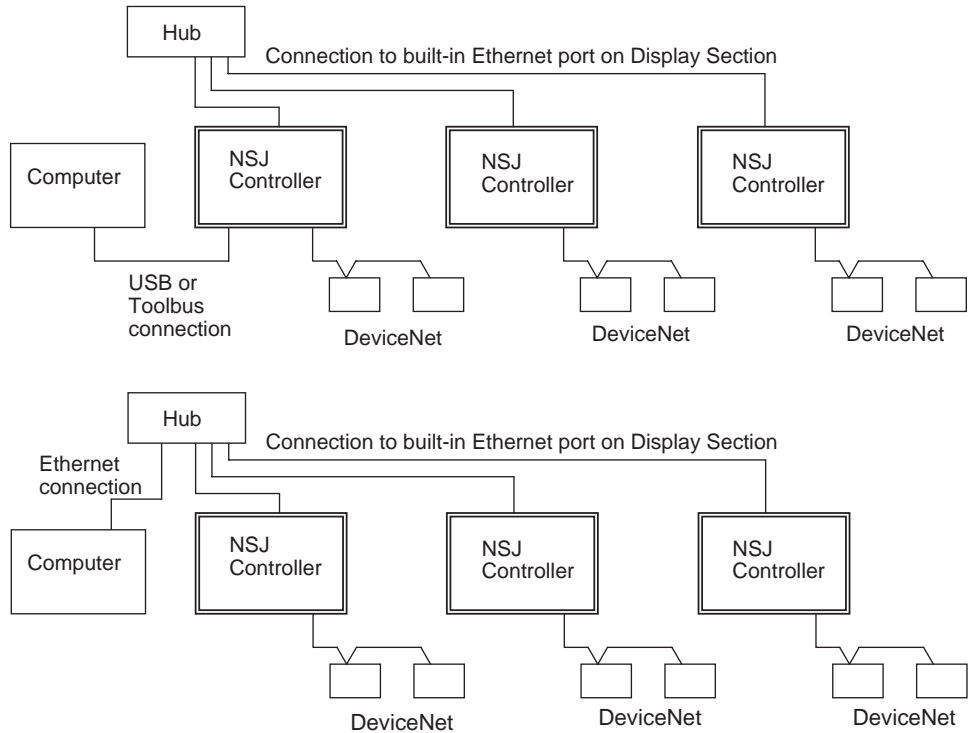

The Ethernet network address and node address must be set in the communications setting on the Comm Tab Page of the System Menu to enable using the built-in Ethernet port of the NSJ Controller. The NSJ Controllers must all be set to the same network address.

Programming Device connection	Local NSJ Controller (directly connected to computer)			Remote NSJ Controller (connected via network)		
	Operating the Controller Section (setting I/O tables, transferring programs, monitoring, etc.)	Setting up DeviceNet	Transferring screens to the Display Section	Operating the Controller Section (setting I/O tables, transferring programs, monitoring, etc.)	Setting up DeviceNet	Transferring screens to the Display Section
USB	Supported	Supported	Supported	Supported	Supported	Supported
Toolbus (serial port A or B)	Supported	Supported	Supported	Supported	Supported	Supported
Built-in Ethernet port	Supported	Supported	Supported	Supported	Supported	Supported

**NSJ Controllers Connected via NSJ Ethernet Units or NSJ Controller Link Units**

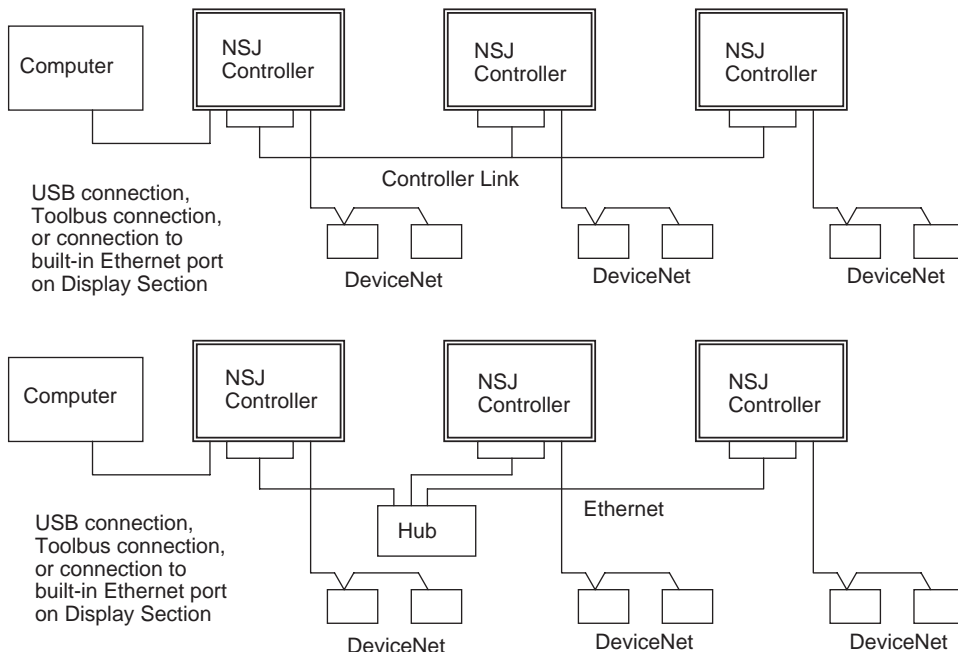

If Ethernet ports are used, the Ethernet network address and node address must be set in the communications setting on the Comm Tab Page of the System Menu to enable using the built-in Ethernet port of the NSJ Controller. The NSJ Controllers must all be set to the same network address. Routing tables must also be set in all of the NSJ Controllers. Refer to *Routing Table Setting Example* on page 16 for a setting example.

Programming Device connection	Setting up Controller Link data links	Local NSJ Controller (directly connected to computer)			Remote NSJ Controller (connected via network)		
		Operating the Controller Section (setting I/O tables, transferring programs, monitoring, etc.)	Setting up DeviceNet	Transferring screens to the Display Section	Operating the Controller Section (setting I/O tables, transferring programs, monitoring, etc.)	Setting up DeviceNet	Transferring screens to the Display Section
USB	Supported	Supported	Supported	Supported	Supported	Supported	Not supported
Toolbus (serial port A or B)	Supported	Supported	Supported	Supported	Supported	Supported	Not supported
Built-in Ethernet port	Supported	Supported	Supported	Supported	Supported	Supported	Not supported

**NSJ Controllers Connected via NSJ Ethernet Units or NSJ Controller Link Units and Connected to a CS/CJ-series PLC**

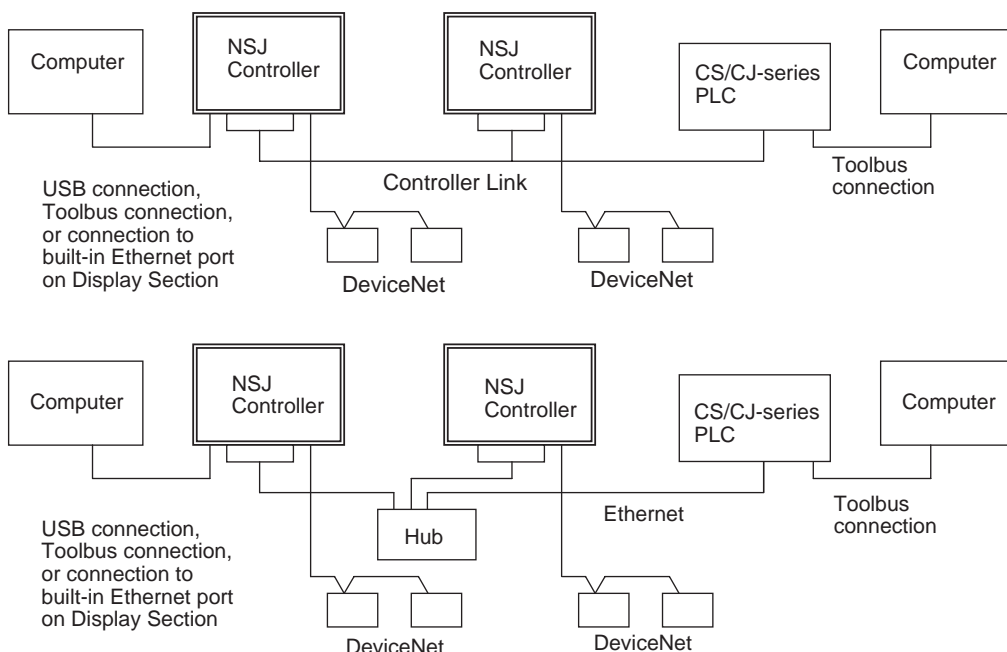

A Programming Device connected to the USB port, a Toolbus port (serial port A or B), or the built-in Ethernet port of the NSJ Controller can access and perform operations for a CS/CJ-series PLC on the same network.

A Programming Device connected to the peripheral port or Host Link port of the NSJ Controller can perform operations, set up DeviceNet, and set up Controller Link data links for the Controller Sections of the NSJ Controllers, but it cannot transfer screen data to the Display Sections of the NSJ Controllers.

To transfer screen data to the Display Section of an NSJ Controller, connect the Programming Device to the USB port, a Toolbus port (serial port A or B), or the built-in Ethernet port of the NSJ Controller.

Routing tables must also be set in all of the NSJ Controllers. Refer to *Routing Table Setting Example* on page 16 for a setting example.

**Note** When a CS/CJ-series PLC is operated via the network from Support Software connected to the built-in Ethernet port of an NSJ Controller, the *Frame Length* under the Network Settings in the Change PLC Type Dialog Box must be changed from the default setting of 2000 to 1004 or less. Communications cannot be executed normally if the frame length is set to 1005 or greater because the maximum frame length of the inner bus in the NSJ Controller is 1004.

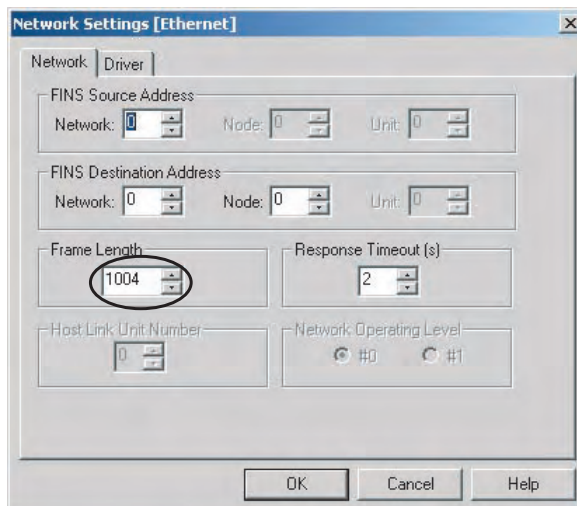

**Routing Table Setting Example**

Routing tables must also be set in all of the NSJ Controllers when using communications applications across a network or when setting an NSJ Controller across a network. Routing tables are not required when using stand-alone NSJ Controllers or when not making NSJ Controller settings across a network.

The routing tables for the following configuration are described in this section as an example. Routing tables are set using the CX-Integrator. Connect the Programming Device to each NSJ Controller and transfer the routing table created for each one.

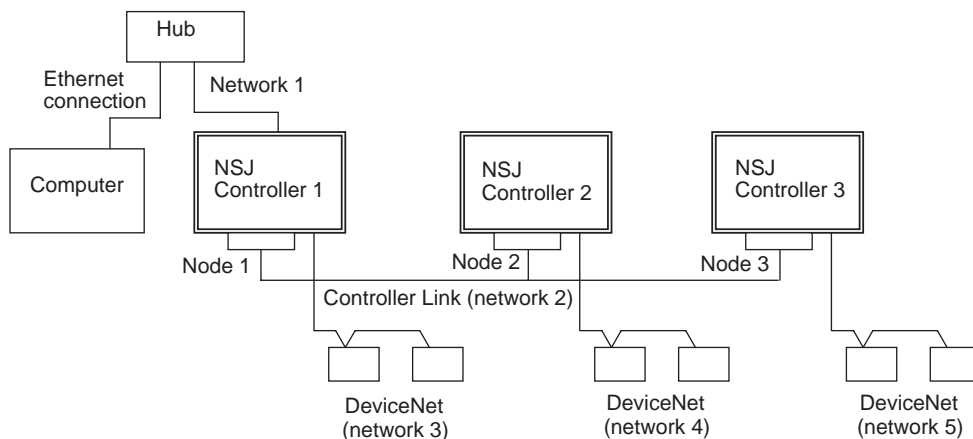

The following unit numbers are used by the NSJ Controller.

Unit number of Built-in DeviceNet: 0

Unit number of NSJ Controller Link Unit



■ Routing Tables for NSJ Controller 1

Local Network Table

Unit number	Local network address
0 (built-in DeviceNet)	3
1 (NSJ Controller Link Unit)	2
228 (built-in Ethernet port)	1

Relay Network Table

Destination network address	Relay network address	Relay node address
4	2	2
5	2	3

Network Address Setting for the Built-in Ethernet Port on the Display Section of the NSJ Controller

The network address for the built-in Ethernet port is set using the communications settings on the Comm Tab Page on the System Menu of the Display Section of the NSJ Controller. Set the network address to 1 (and set the IP address and subnet mask). The address set here (1) is the same as the value set in the local routing tables given above (228: built-in Ethernet port).

**Note** Set the same network address for the built-in Ethernet on the System Menu of the Display Section and in the routing tables of the Controller Section.

■ Routing Tables for NSJ Controller 2

Local Network Table

Unit number	Local network address
0 (built-in DeviceNet)	4
1 (NSJ Controller Link Unit)	2

Relay Network Table

Destination network address	Relay network address	Relay node address
1	2	1
3	2	1
5	2	3

■ Routing Tables for NSJ Controller 3

Local Network Table

Unit number	Local network address
0 (built-in DeviceNet)	5
1 (NSJ Controller Link Unit)	2

Relay Network Table

Destination network address	Relay network address	Relay node address
1	2	1
3	2	1
4	2	2

**Note** (1) When routing tables are transferred to the NSJ Controller from a Programming Device, the built-in DeviceNet Section, Expansion Unit, and Display Section of the NSJ Controller will be reset to enable using the

new routing tables. Always confirm that resetting these parts of the NSJ Controller will not adversely affect the system before transferring the routing tables.

- (2) A communications error will occur when a Programming Device is connected to the NSJ Controller and the Display Section is reset as a result of transferring the routing tables. After the Display Section is restarted, it may be necessary to connect/disconnect the Programming Device's on-line connection.

### Routing Table Precautions

#### ■ Setting the Network Address for the Built-in Ethernet Port

To set the network address for the built-in Ethernet port on the NSJ Controller, start the routing table setting tool from the CX Integrator and enter the network address for the built-in Ethernet port for port 1 of Unit 225 (Inner Board).

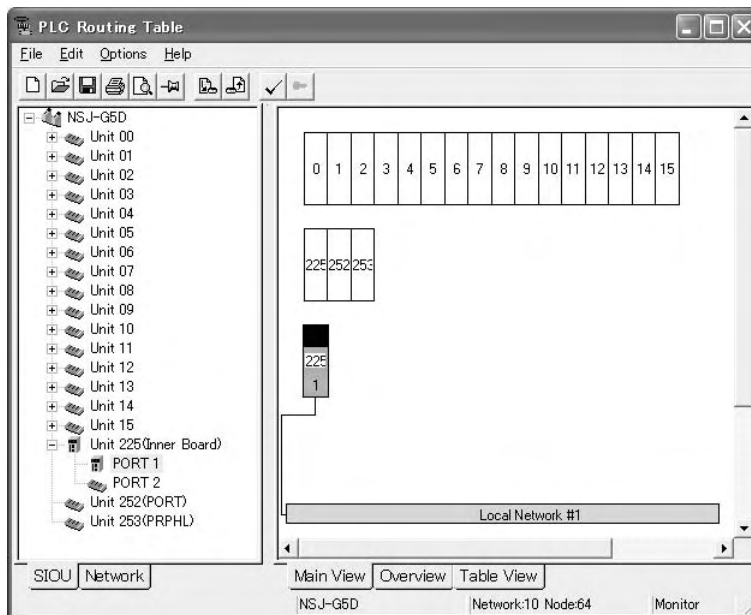

Click the **Table View** Tab, and the network address will be set for unit number 228. When setting the routing tables directly on the Table View Tab Page, set the unit number to 228.

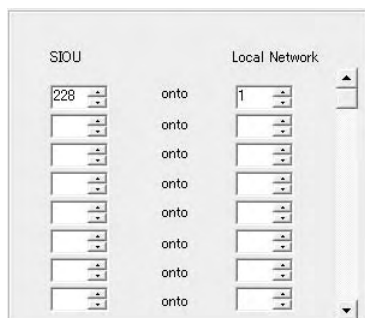

#### ■ Using the NSJ Controller without Routing Tables

The NSJ Controller can be used without setting routing tables in the following cases.

**Stand-alone NSJ Controllers**

- Routing tables do not need to be set when the Programming Device is connected to the USB port or Toolbus port (serial port A or B) on an NSJ Controller.
- If the Programming Device is connected to the built-in Ethernet port on the NSJ Controller, set the network address of the built-in Ethernet port from the System Menu of the Display Section. Routing tables do not need to be set.

**Networked NSJ Controllers Not Using Communications Applications and for Which Settings Are Not Performed via the Network**

To set up the NSJ Controllers, connect the Programming Device to the USB port or Toolbus port (serial port A or B) on each NSJ Controller.

**NSJ Controllers Networked with NSJ Ethernet Units or NSJ Controller Link Units with a Programming Device Connected to the USB Port or Toolbus Port (Serial Port A or B) on an NSJ Controller**

Routing tables must be set in NSJ Controllers if more than one Communications Unit (including the built-in DeviceNet master of the NSJ Controller or Communications Units on Expansion Racks connected via an NSJ I/O Control Unit) is used. Routing tables do not need to be set, however, if the unit number of the built-in DeviceNet master is set to a smaller number than the unit number of the NSJ Ethernet Unit or NSJ Controller Link Unit. Controller Link data links can be set by setting the network address to 0 from the Programming Device.

## 1-2 Differences between the NSJ Controller and Previous Products

This section describes the differences between the Controller Section of the NSJ Controller and a CJ-series CJ1G-CPU45H CPU Unit and between the Display Section of the NSJ Controller and an NS-series PT.

### 1-2-1 Differences between Controller Sections and CJ1G-CPU45H for All Models of NSJ Controllers

Item	CJ1G-CPU45H	Controller Section
Power supply	A Power Supply Unit is required.	A Power Supply Unit is not required. (An external 24-V DC power supply is connected to provide power to both the Display Section and Controller Section.)
DeviceNet Unit	A DeviceNet Unit must be mounted separately as a CPU Bus Unit.	DeviceNet master functionality is built in. The functionality is equivalent to that of the CJ1W-DRM21.
CJ-series Basic I/O Units, Special I/O Units, and CPU Bus Units	CJ-series Units can be mounted.	<ul style="list-style-type: none"> <li>• NSJ Expansion Units can be used instead of CJ-series Ethernet or Controller Link Units (NSJW-ETN21 NSJ Ethernet Unit and NSJW-CLK21-V1 NSJ Controller Link Unit).</li> <li>• An NSJ I/O Control Unit (NSJW-IC101) can be mounted to enable mounting CJ-series Basic I/O Units, Special I/O Units, and CPU Bus Units to CJ-series Expansion Racks.</li> </ul>
Peripheral port	A peripheral port is provided.	There is no peripheral port, but a USB port is provided instead. A Programming Console cannot be connected.
PLC Setup	---	<p>Operation Startup Condition Settings are provided.</p> <p>Operation startup settings can be made after the Display Section starts up.</p>
Easy backup function	The easy backup function is controlled using DIP switch settings.	DIP switch settings can be used, but the backup and comparison features of the easy backup function can also be controlled from the System Menu of the Display Section. Data cannot be restored from the Display Section.
Auxiliary Area bit allocations	---	<p>The following bits have been added to the Auxiliary Area.</p> <ul style="list-style-type: none"> <li>• A35500: Display Section Initializing Flag</li> <li>• A39500: Fatal Error Flag</li> <li>• A39501: Non-fatal Error Flag</li> <li>• A40112: Display Section Fatal Error Flag</li> <li>• A40108: Display Section Non-fatal Error Flag</li> <li>• A42400 to A42403: Display Section Fatal Error Details</li> <li>• A42404 to A42415: Display Section Non-fatal Error Details</li> <li>• A60800: Display Section Restart Bit</li> <li>• A34312: Verification Mismatch Flag</li> </ul>
Inner Board Area allocations	---	<p>A Display Section Status Area has been added.</p> <ul style="list-style-type: none"> <li>• CIO 1900: Display Section Mode Status</li> <li>• CIO 1901: Display Section Screen Transfer Status</li> <li>• CIO 1902: Display Section Error Status</li> </ul>
Power interruption detection delay	0 to 10 ms (Set by user; default: 0 ms)	Always 0 ms

### 1-2-2 Differences between NSJ□-□□□□(B)-M3D Controller Sections and CJ1G-CPU45H

Item		CJ-series CJ1G-CPU45H	NSJ Controller Section
I/O capacity		1,280 points	640 points
Program capacity		60 Ksteps	20 Ksteps
Expansion Racks		3 max.	1 max.
EM Area		32 Kwords x 3 banks E0_00000 to E2_32767	None
Function blocks	Definitions	1,024 max.	128 max.
	Instances	2,048 max.	256 max.
Flash memory	FB program memory	1,024 Kbytes	256 Kbytes
	Variable tables	128 Kbytes	64 Kbytes

### 1-2-3 Differences between Display Section and NS-series PT

Item		NS-series PT	Display Section
PLC/DeviceNet troubleshooting functions		Not supported	Supported (built-in) <ul style="list-style-type: none"> <li>Controller Section and DeviceNet troubleshooting can be selected from the System Memory of the Display Section.</li> <li>The alarm function of the Display Section can be registered to display the Controller Section/DeviceNet Troubleshooting Screen when an alarm occurs.</li> <li>Command buttons can be created to switch the screen to the Controller Section /DeviceNet Troubleshooting Screen.</li> </ul>
Clock		CPU Unit and PT cannot be synchronized.	The Display Section is synchronized to the Controller Section. The clock in the Controller Section can be set from the System Menu of the Display Section.
Ladder monitor function	Display Section system version 6.5	Supported (Copied to Memory Card) (See note 1.)	Not supported
	Display Section system version 6.6	Built-in (See notes 1 and 2.)	Built-in (See note 1.)
PT Programming Console function	Display Section system version 6.5	Supported (Copied to Memory Card)	Not supported
	Display Section system version 6.6	Supported (See note 3.)	Supported (See note 4.)
Device monitoring function		Supported	Supported
Built-in serial ports (serial ports A and B)		The ports cannot be used to access the CPU Unit without setting routing tables.	The Controller Section can be accessed from a Programming Device (CX-Programmer or CX-Integrator).
Built-in Ethernet port			The Controller Section can be accessed from a Programming Device (CX-Programmer or CX-Integrator).

- Note**
- (1) Ladder monitoring cannot be performed with the NS5 or NSJ5.
  - (2) With version-1 Controllers (-V1), copy the program to a Memory Card to use ladder monitoring.
  - (3) The Programming Console function is built into the NS12/10/8-V2 Controllers. With other Controllers, copy the program to a Memory Card to use the Programming Console function.
  - (4) The Programming Console function cannot be used with a built-in Controller Section. It can be used only through a NT Link (serial port A or B) when connected to another PLC. Also the program must be copied to a Memory Card to use the Programming Console function.

### 1-2-4 Comparison of Ethernet Functionality for NSJ Controllers

Item	Built-in Ethernet ports	NSJ Ethernet Unit
Displaying and Setting Data for Another Host (PLC)	Data can be displayed and set for other hosts on the Ethernet network. For example, it is possible to display and set at one NSJ Controller the data of another NSJ Controller or PLC.	The same functions are supported as described to the left for the built-in Ethernet port.
Connection to a host computer	<p>Programming Device connections: Ethernet can be used for CX-One (CX-Programmer, CX-Designer, etc.). Screen data and ladder programs can be transferred from the host computer.</p> <p>Accessing Display Section Memory Cards: Ethernet can be used for accessing special tools from the host computer or accessing Display Section Memory Cards by FTP. For example, Display Section recipe data, alarms, and data log files can be acquired from the host computer.</p> <p>Accessing the host from host applications: The Controller Section of an NSJ Controller can be accessed from the host computer using FINS communications. For example, NSJ Controller DM can be read and written from applications on the host computer. (UDP only)</p>	<p>The same functions are supported as described to the left for the built-in Ethernet port (except that Display Section Memory Cards cannot be accessed).</p> <p>In addition, the following functions are supported:</p> <p>Accessing Controller Section Memory Cards</p> <p>Clock-setting using SNTP function</p> <p>TCP/IP compatibility</p>
Sending and receiving Email	Not supported	Supported
Communications by executing ladder program instructions	Not supported	Socket service communications by executing the CMND instruction SEND and RECV instructions

Screen data can be transferred between NSJ Controllers using the CX-Designer across networks only if the NSJ Controllers are connected by the built-in Ethernet ports on the NSJ controller.

## 1-3 Internal Operation of NSJ Controllers

The internal operation of the NSJ Controller is described in this section.

- The Controller Section and Display Section exchange data using the Inner bus.
- The DeviceNet master function as well as the NSJ Controller Link Unit or NSJ Ethernet Unit (Expansion Units) are handled as CJ-series CPU Bus Units. CIO Area and DM Area words are allocated to these according the unit numbers.

- CJ-series Expansion Racks can be connected by mounting an NSJ I/O Control Unit. This enables mounting CJ-series Units.

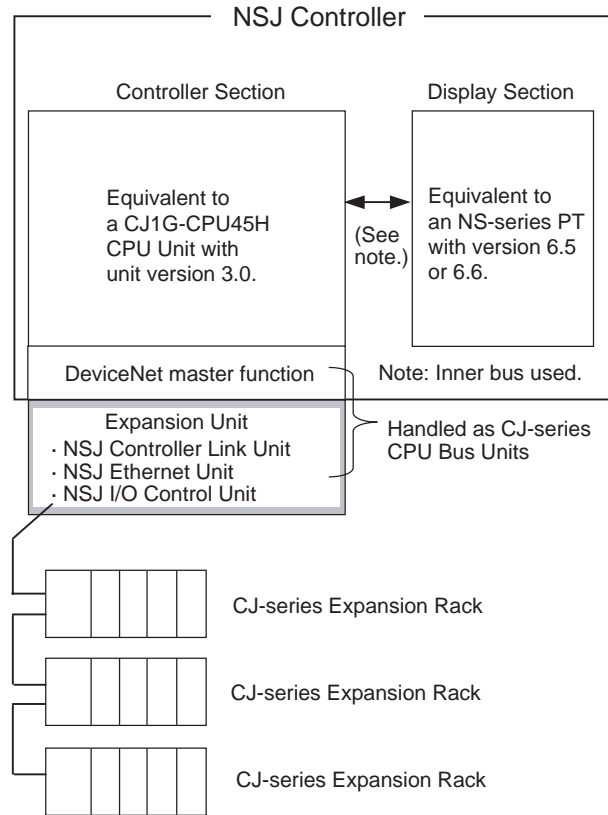

## 1-4 Application Precautions

- For the Programming Device, use CX-One version 2.0 or higher for the NSJ□-□□□□(B)-M3D and use CX-One version 1.1 or higher for the NSJ Controller. CX-One version 1.0 or lower does not support NSJ Controllers.
- NS-Designer version 6.2 or lower cannot be used to create screen data or to transfer screen data to the Display Section of the NSJ Controller. Use the CX-Designer bundled in CX-One version 1.1 or higher.
- The NSJ Controller does not have a peripheral port. Connect the Programming Device to the USB port or one of the serial ports (port A or B).
- More than one Support Software package (e.g., the CX-Programmer and CX-Designer) can be connected to the NSJ Controller at the same time. Online operations will be interrupted while screen data is being transferred using the CX-Designer, but will be enabled again once the transfer has been completed.
- The Display Section will be reset after screen data has been transferred. If other applications are connected online with the NSJ Controller, communications errors will occur until the Display Section has started up again. With the USB port, the online connection will be automatically restored. With a Toolbus connection (serial port A or B), the connection will not be automatically restored and the connection must be made again manually.

- Serial port C (on the Controller Section) has the same functionality as the RS-232C port on a CJ1-H CPU Unit with unit version 3.0 except that a Programming Device cannot be connected to serial port C. Connect the Programming Device to the USB port or one of the serial ports (port A or B).
- There is no peripheral port and a Programming Console thus cannot be connected. Use the device monitoring function on the System Menu of the Display Section for simple present value monitoring, present value setting, and similar operations.
- Set the same network address for the built-in Ethernet on the System Menu of the Display Section and in the routing tables of the Controller Section.
- When routing tables are transferred to the NSJ Controller from a Programming Device, the built-in DeviceNet Section, Expansion Unit, and Display Section of the NSJ Controller will be reset to enable using the new routing tables. Always confirm that resetting these parts of the NSJ Controller will not adversely affect the system before transferring the routing tables.
- A communications error will occur when a Programming Device is connected to the NSJ Controller and the Display Section is reset as a result of transferring the routing tables. After the Display Section is restarted, it may be necessary to connect/disconnect the Programming Device's online connection.
- An NS-AL002 RS-232C/RS-422A Conversion Unit cannot be connected to serial port C. If the NS-AL002 is connected to serial port A on the NSJ5-□□□□-□□□, it will not be physically possible to connect serial port C. If the NS-AL002 is connected to serial port A or B on the NSJ8/10/12-□□□□-□□□, serial port C cannot be used.
- Memory Cards are formatted before they are shipped. The user does not have to format them before use. To reformat a Memory Card after use, always use the CX-Programmer and format it in the Memory Card slot of the Controller Section (MC (CONTROLLER) slot). The NSJ Controller may not recognize a Memory Card that was formatted on a personal computer. A Memory Card formatted on a personal computer may not be usable with the NSJ Controller even after reformatting the Memory Card in the NSJ Controller.
- Applications started with the external application startup function of the Display Section of the NSJ Controller cannot use the Programming Console function for the Controller Section. These can be used only for PLCs connected to serial port A or B of the NSJ Controller.
- Always use RecoverUpdate\_6\_5 NSJ\_HSH or a higher version ("6\_5" is shown as version V6.5) when using the recovery/update function for the Display Section of the NSJ Controller. Data older than version 6.5 cannot be used with the Display Section of the NSJ Controller.
- A DeviceNet multidrop connector cannot be connected to serial port B on the NSJ5-□□□□-□□□. Do not use it. DeviceNet multidrop connectors cannot be used with the NSJ8/10/12-□□□□-□□□.



- As shown in the following diagrams, corresponding terminals of the NSJ Controller Link Unit are internally connected. If the communications connector is separated from a Unit, the communications line will be broken and communications will be disabled. Use a Repeater Unit if it is necessary to add or delete nodes during operation.

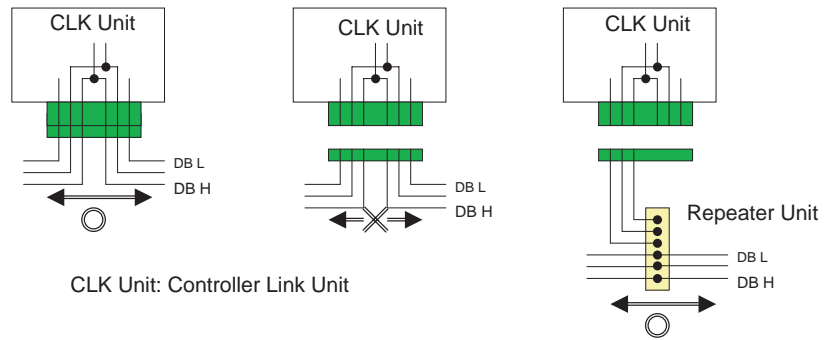



# SECTION 2

## Basic Operating Procedures

This section provides the basic operating procedures required to use the NSJ-series NSJ Controller.

2-1	Overall Operating Procedure . . . . .	28
2-2	Installing the USB Driver . . . . .	28
2-3	Operating Procedure for the Controller Section . . . . .	35
2-4	Operating Procedure for the Display Section . . . . .	36

## 2-1 Overall Operating Procedure

The overall procedure required setup an NSJ Controller is given below.

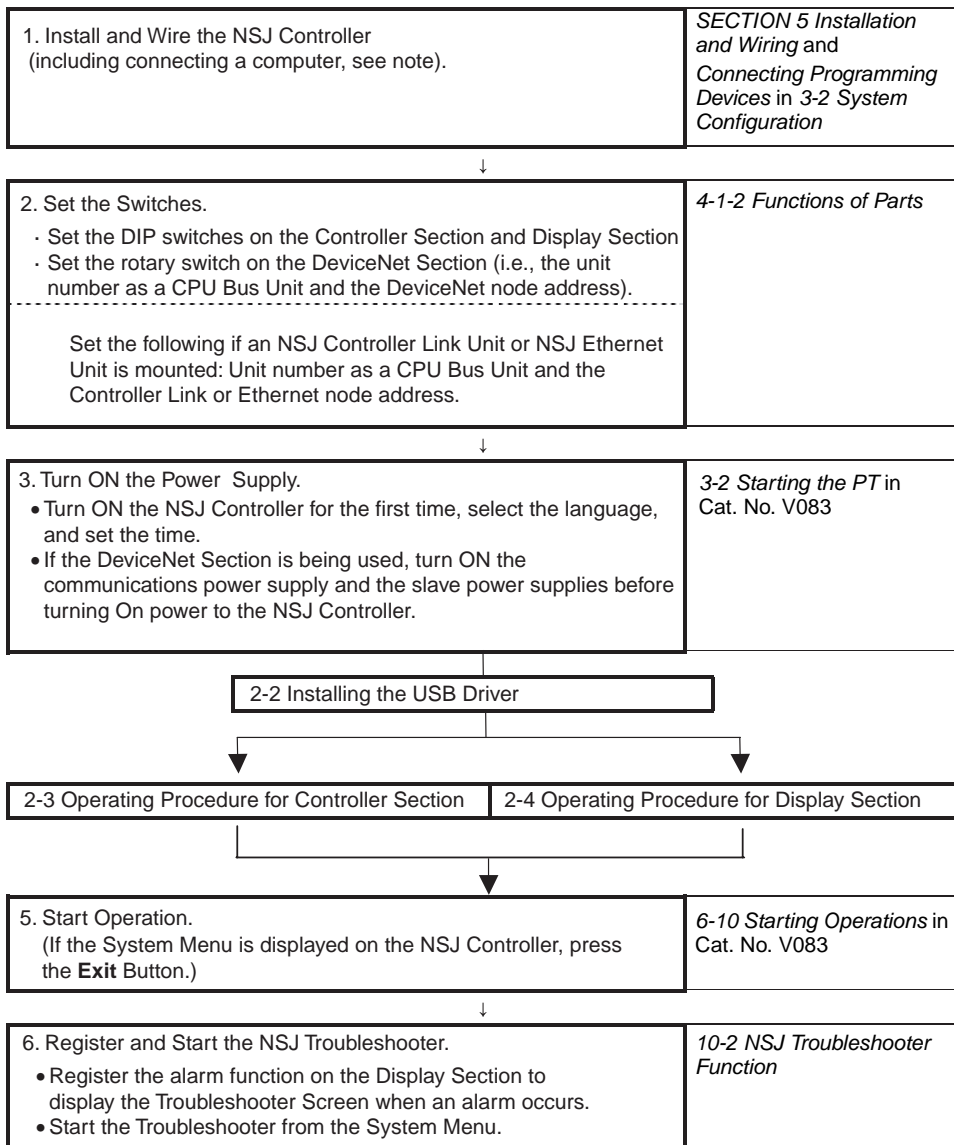

**Note** Here, the procedure is shown for connecting the computer and NSJ Controller with a USB cable.

## 2-2 Installing the USB Driver

Install the USB driver in the personal computer. After installation, data can be transferred between the personal computer and NSJ Controller via USB.

### Applicable Operating Systems

Windows 98SE, Windows Me, Windows 2000, and Windows XP

### Operation Procedure

#### Windows 2000 and Windows XP

- 1,2,3...**
1. Start Windows 2000 or Windows XP.
  2. Connect the personal computer to the USB slave connector using the USB cable. The following Found New Hardware Wizard will be displayed.

- For Windows 2000, select *Display a list of the known drivers for this device so that I can choose a specific driver* and click the **Next** Button. For Windows XP, select *Install from a list or specific location (Advanced)* and click the **Next** Button.



- The dialog box shown below will be displayed. Confirm that **Search for the best driver for my device (Recommended)** is selected. Select the **Include this location in the search** option, click the **Browse** Button and specify the following CX-Server installation directory folder:  
\\USB  
Then click the **Next** Button.

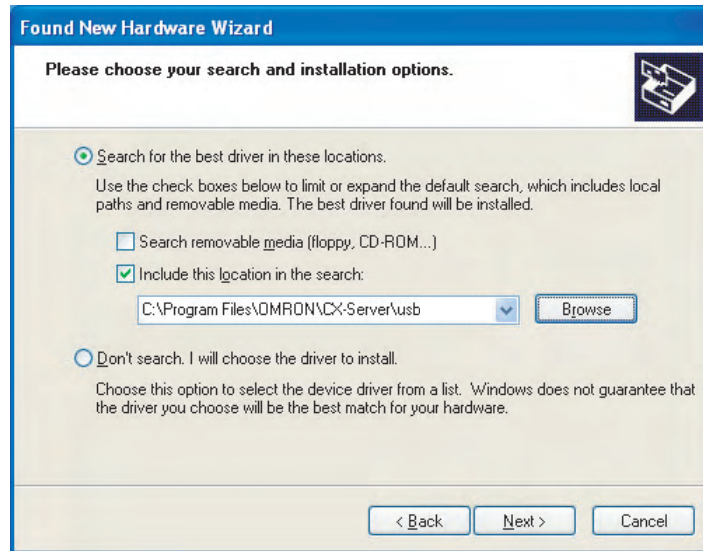

5. The dialog box shown below will be displayed. Click the **Continue Anyway** Button.



6. When installation is completed, the following dialog box will be displayed. Click the **Finish** Button.



**Windows 98SE and Windows Me****1,2,3...**

1. Start Windows 98SE or Windows Me.
2. Connect the personal computer to the USB slave connector using the USB cable. The following Add New Hardware Wizard will be displayed. Click the **Next** Button.

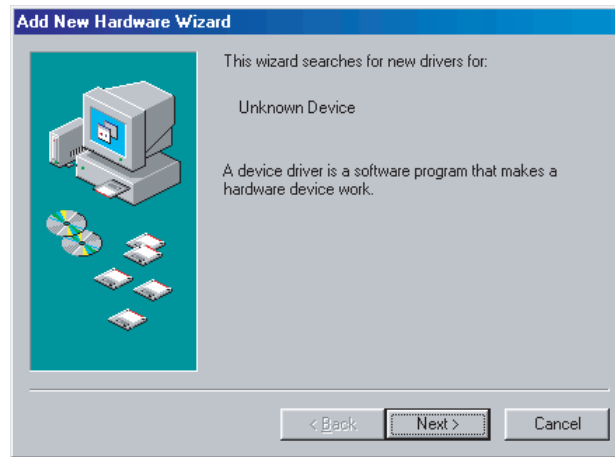

3. The following dialog box will be displayed. Select **Search for the best driver for your device (Recommended)**. Click the **Next** Button.



4. Select **Specify a location** only and then click the **Browse** Button and specify the following directory.  
CX-Server installation directory  
\\USB



5. Click the **Next** Button.

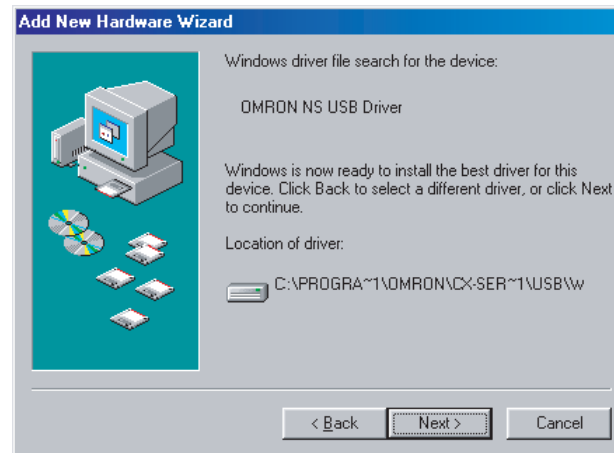

6. Click the **Next** Button to start installation. When installation is completed, the following dialog box will be displayed. Click the **Finish** Button.

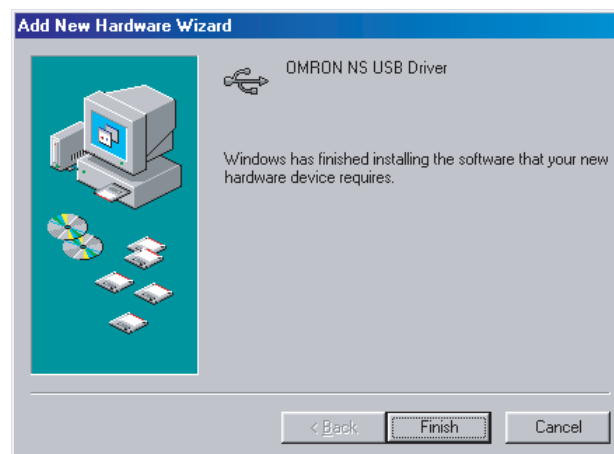



- The Add New Hardware Wizard will be displayed again. Click the **Next** Button.

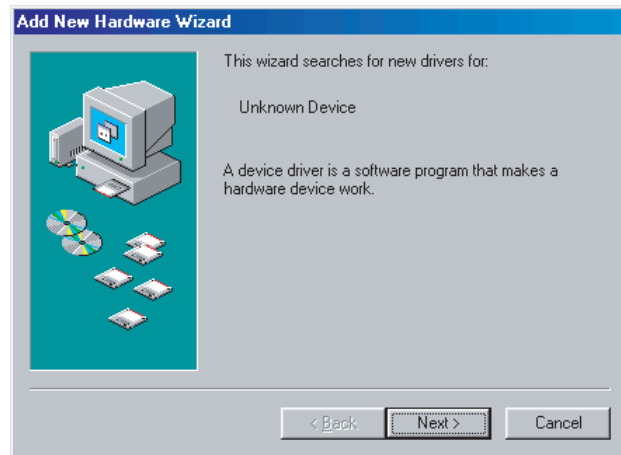

- The following dialog box will be displayed. Check that **Search for the best driver for your device (Recommended)** is selected, and then click the **Next** Button.

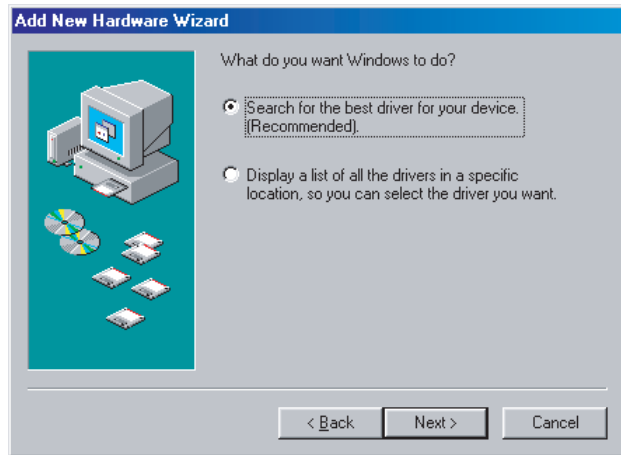

- Select **Specify a location** only and then click the **Browse** Button and specify the following directory.  
CX-Server installation directory  
\\USB

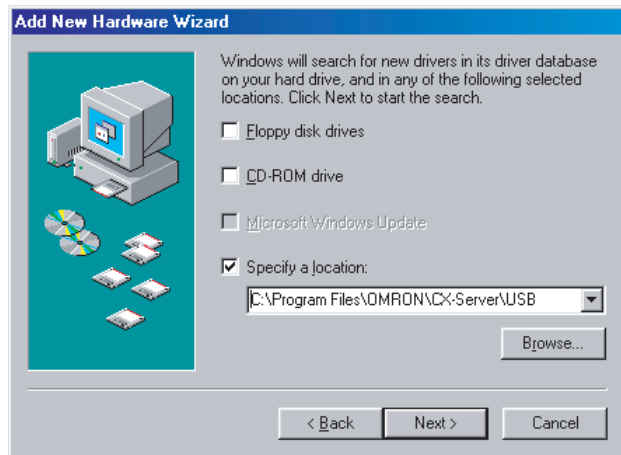

- 10. Click the **Next** Button.



- 11. Click the **Next** Button to start installation.  
When installation is completed, the following dialog box will be displayed.  
Click the **Finish** Button.

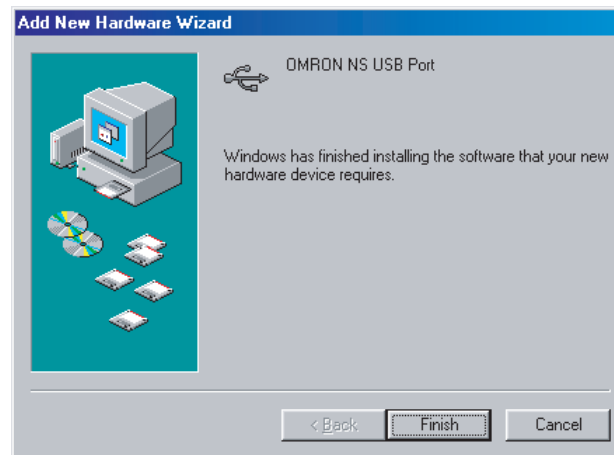

## 2-3 Operating Procedure for the Controller Section

<p>1. Start the CX-Programmer.                  Select <b>Programs - OMRON - CX-One - CX-Programmer - CX-Programmer</b> (assuming that the CX-Programmer was installed in the CX-Programmer group) or right-click the NSJ Controller in the Network Configuration Window of the CX-Integrator and select <b>Start Special Application - Start Only</b> from the pop-up menu.</p>	<p><i>CX-Programmer Operation Manual</i> (Cat. No. W446)</p>
↓	
<p>2. Create a New Project.                  Select File - New.</p>	<p><i>CX-Programmer Operation Manual</i> (Cat. No. W446)</p>
↓	
<p>Input the following in the Change PLC Dialog Box.</p> <ul style="list-style-type: none"> <li>• Device Name</li> <li>• Select NSJ in the Device Type Field.</li> <li>• Select USB in the Network Type Field.</li> </ul>	
↓	
<p>3. Connect Online and Create I/O Tables.                  Right-click the NSJ Controller in the I/O tables and select <b>Start Special Application - Start Only</b> to start the CX-Designer. (See note.)                  Set the following as required.</p> <ul style="list-style-type: none"> <li>• Routing tables</li> <li>• Built-in DeviceNet Section (Right-click <i>DeviceNet</i> in the I/O tables.)</li> <li>• NSJ Controller Link (Right-click <i>Controller Link</i> in the I/O tables.)</li> </ul>	<p><i>CX-Programmer Operation Manual</i> (Cat. No. W446)  <i>Section 3 Routing Tables, Section 4 Data Links for Controller Link and SYSMAC LINK, and Section 6 DeviceNet in CX-Integrator Operation Manual</i> (Cat. No. W464)</p>
↓	
<div style="border: 1px solid black; padding: 2px; display: inline-block;">→ 2-4 Operating Procedure for Display Section</div>	
↓	
<p>4. Set and Transfer the PLC Setup (as required).</p>	<p><i>CX-Programmer Operation Manual</i> (Cat. No. W446)</p>
↓	
<p>5. Create, Transfer, and Monitor the Program.</p>	<p><i>CX-Programmer Operation Manual</i> (Cat. No. W446)</p>
↓	
<p>6. Change the Operating Mode to MONITOR or RUN.</p>	

**Note** The CX-Designer can be started from the I/O tables in the CX-Programmer if the CX-Programmer is installed as part of the CX-One.

## 2-4 Operating Procedure for the Display Section

The following procedure outlines how to create screens and transfer them to the Display Section using the CX-Designer. Refer to the following manuals for details: *CX-Designer Operation Manual (V099)*, *CX-Designer Help*, *NS-series PT Setup Manual (V083)*, and *NS-series PT Programming Manual (V073)*.

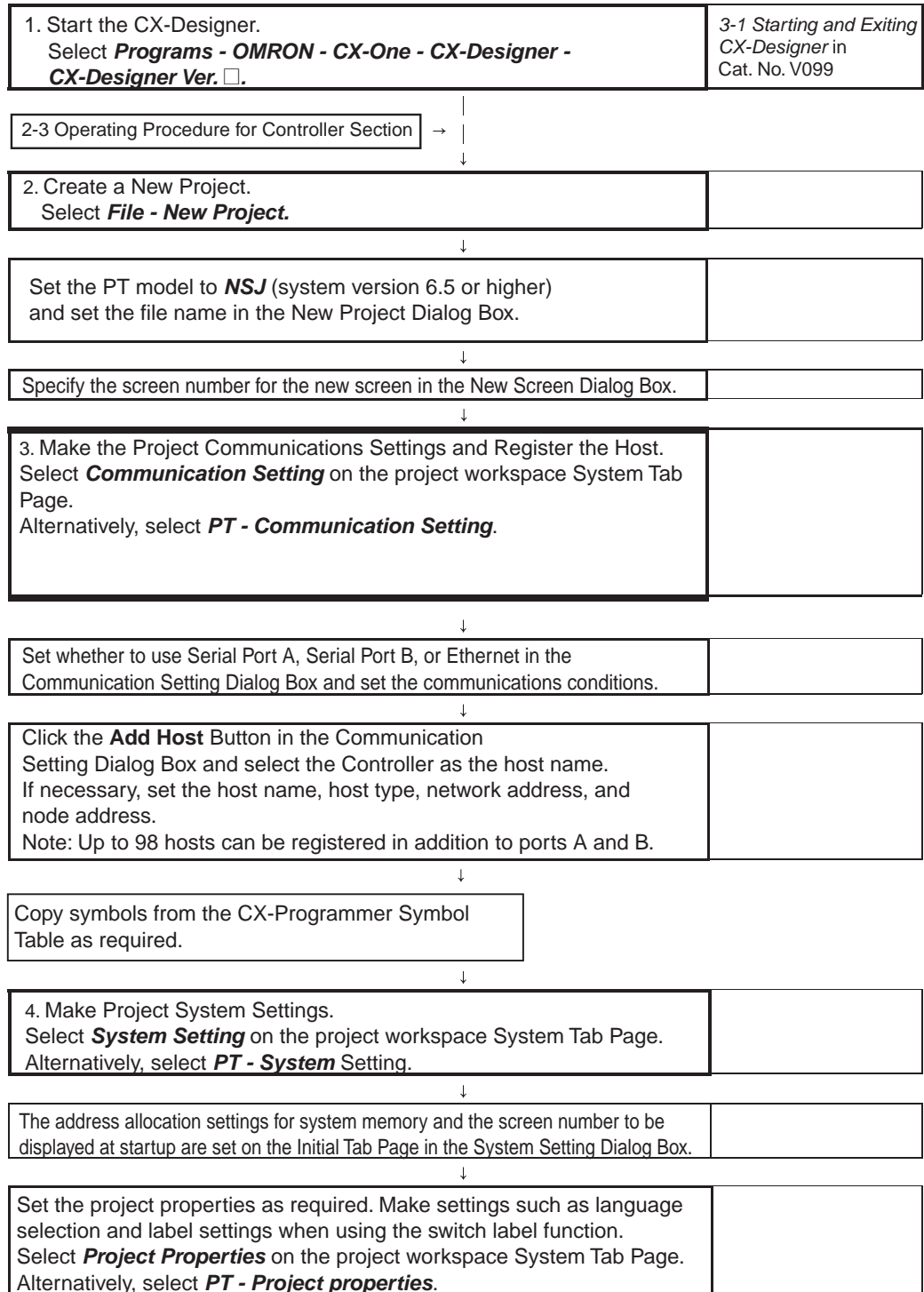

**Note** The settings made in the System Setting Dialog Box will overwrite the settings made from the System Menu of the Display Section when screens are transferred.

↓	
Set the screen properties as required. Set the screen title, size, pop-up screen setting, background and other settings. Select <b>PT - Screen/sheet properties.</b>	
↓	
7. Create a New Screen. Select <b>File - New Screen.</b>	
↓	
8. Create Functional Objects.	
↓	
Select the functional object from the toolbar. Move the cursor to the screen and drag the cursor from the start point to the end point of the functional object.	
↓	
Select the functional object just placed on the screen and make address and other settings from the property list. (Select the host name and set the address. The address can also be set by selecting a symbol from the symbol table.)	
↓	
Also set the properties for that functional object.	
↓	
9. Save the Screen. Select <b>File - Save Screen/Sheet.</b>	
↓	
10. Save the Project. Select <b>File - Save All.</b>	
↓	
11. Print data as required. Select <b>File - Print.</b>	
↓	
12. Check operation using the screen data on the CX-Designer if required. Select <b>Tools - Test.</b>	4-13 Integrated Simulation for the Entire System in Cat. No. V099
↓	
13. Transfer the screen data to the NSJ Controller.	
↓	
Select the communications method. Select <b>PT - Transfer - Transfer Setting.</b>	
↓	
Transfer the screen data. Select <b>PT - Transfer - Transfer [Computer → PT].</b>	
↓	
14. Restart the Display Section Automatically. (Automatically restarting the Display Section can be set when transferring screen data.)	



# SECTION 3

## Specifications and System Configurations

This section provides the specifications of the NSJ-series NSJ Controller and describes the system configurations in which it is used.

3-1	Specifications .....	40
3-1-1	General Specifications .....	40
3-1-2	Performance Specifications .....	44
3-2	System Configuration .....	64
3-2-1	Basic System Configuration .....	64
3-2-2	Expanded System Configurations .....	70

## 3-1 Specifications

### 3-1-1 General Specifications

#### NSJ Controller

Item		Specifications			
Model		NSJ12-TS□□-G5D	NSJ10-TV□□-G5D	NSJ8-TV□□-G5D NSJ8-TV□□-M3D	NSJ5-TQ□□-G5D NSJ5-SQ□□-G5D NSJ5-TQ□□-M3D NSJ5-SQ□□-M3D
Supply voltage		24 V DC			
Allowable supply voltage range		20.4 to 27.6 V DC (24 V DC ±15%)			
Power consumption		30 W max.		SQ□□: 21 W max. TQ□□: 22 W max.	
Current consumption		Controller Section, internal 5 V: 500 mA max. DeviceNet Section, internal 5 V: 200 mA max. DeviceNet Section, external 24 V: 18 mA max.			
Inrush current (See note 1.)		At 24 V DC: 10 A max. (for cold start) for 20 ms max.			
Ambient operating temperature (depending on angle of display surface off horizontal)		60° to 90°: 0 to 50°C 30° to 60°: 0 to 45°C 0° to 30°: Use prohibited.		30° to 90°: 0 to 50°C 0° to 30°: 0 to 40°C	
Ambient storage temperature		-20 to 60°C			
Ambient operating humidity		0° to 40°C: 35% to 85% (with no condensation) 40° to 50°C: 35% to 60% (with no condensation)			
Ambient operating environment		Must be no corrosive gases.			
Insulation resistance		20 MΩ (at 100 V DC) between DC power supply terminals in power supply terminal section and functional ground terminal			
Dielectric strength		800 V DC for 1 minute between DC power supply terminals in power supply terminal section and functional ground terminal with leakage current of 10 mA max.			
Noise immunity		2 kV on power supply line (conforming to IEC61000-4-4)			
Vibration resistance (during operation)		10 to 57 Hz, 0.075-mm amplitude, 57 to 150 Hz, acceleration: 9.8 m/s <sup>2</sup> in X, Y, and Z directions for 80 minutes			
Shock resistance (during operation)		147 m/s <sup>2</sup> 3 times each in X, Y, and Z directions			
External dimensions (See note 3.)	Without Expansion Unit	315 x 241 x 73.3 mm (W x H x D)	232 x 177 x 73.3 mm (W x H x D)	195 x 142 x 79 mm (W x H x D)	
	With Expansion Unit	315 x 241 x 89.3 mm (W x H x D)	232 x 177 x 89.3 mm (W x H x D)	195 x 142 x 95 mm (W x H x D)	
Panel cutout dimensions		Width: 302 <sup>+1</sup> <sub>0</sub> mm Height: 228 <sup>+1</sup> <sub>0</sub> mm Panel thickness: 1.6 to 4.8 mm	Width: 220.5 <sup>+0.50</sup> <sub>0</sub> mm Height: 165.5 <sup>+0.50</sup> <sub>0</sub> mm mm Panel thickness: 1.6 to 4.8 mm	Width: 184 <sup>+0.50</sup> <sub>0</sub> mm Height: 131 <sup>+0.50</sup> <sub>0</sub> mm Panel thickness: 1.6 to 4.8 mm	
Grounding		Ground to 100 Ω or less.			
Weight		2.7 kg max.	2.5 kg max.	2.0 kg max.	1.1 kg max.
Enclosure		Front surface operating section: Equivalent to IP65 oil-proof type, NEMA4 (See note 4.)			
Battery life		5 years (at 25°C) The SRAM and RTC will be backed up for 5 days after the battery runs low (i.e., after the indicator lights orange). The SRAM and RTC will be backed up by a super capacitor for 5 minutes after removing the old battery. (The power must first be turned ON for at least 5 minutes before turning it OFF.)			
International standards		cULus and EC Directives			

**Note** (1) A delay circuit that charges a capacitor is used to limit the inrush current. If a hot start is performed when the power supply has been OFF only a short period of time, the capacitor will still be charged and the inrush current specified above will be exceeded by up to approximately five times



the specified value. When selecting fuses or breakers for external circuits, allow sufficient margin in shut-off performance.

(2) Display angles off horizontal are as follows:

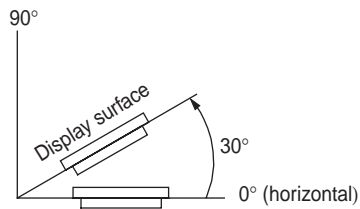

(3) Refer to 4-2-1 Dimensions for details.

(4) May not be applicable in locations with long-term exposure to oil.

**NSJ Controller Link Unit**

Item	Specifications
Model	NSJW-CLK21-V1
Current consumption	300 mA
Weight	100 g max.

Other specifications conform to those of the NSJ Controller.

**NSJ Ethernet Unit**

Item	Specifications
Model	NSJW-ETN21
Current consumption	370 mA
Weight	100 g max.

Other specifications conform to those of the NSJ Controller.

**NSJ I/O Control Unit**

Item	Specifications
Model	NSJW-IC101
Current consumption	20 mA
Weight	100 g max.

Other specifications conform to those of the NSJ Controller.

**Power Supply Unit (when Connecting CJ-series Racks)**

Item	Specifications				
Power Supply Unit	CJ1W-PA205R	CJ1W-PA205C	CJ1W-PA202	CJ1W-PD025	CJ1W-PD022
Supply voltage	100 to 240 V AC (wide-range), 50/60 Hz			24 V DC	
Operating voltage and frequency ranges	85 to 264 V AC, 47 to 63 Hz			19.2 to 28.8 V DC	21.6 to 26.4 V DC
Power consumption	100 VA max.		50 VA max.	50 W max.	35 W max.
Inrush current (See note 1.)	At 100 to 120 V AC: 15 A/8 ms max. for cold start at room temperature At 200 to 240 V AC: 30 A/8 ms max. for cold start at room temperature		At 100 to 120 V AC: 20 A/8 ms max. for cold start at room temperature At 200 to 240 V AC: 40 A/8 ms max. for cold start at room temperature	At 24 V DC: 30 A/20 ms max. for cold start at room temperature	
Output capacity	5.0 A, 5 V DC		2.8 A, 5 V DC	5.0 A, 5 V DC	2.0 A, 5 V DC
	0.8 A, 24 V DC		0.4 A, 24 V DC	0.8 A, 24 V DC	0.4 A, 24 V DC
	Total: 25 W max.		Total: 14 W max.	Total: 25 W max.	Total: 19.6 W max.
Output terminal (service supply)	Not provided				
Replacement notification function	Not provided.	Provided. Alarm output (open-collector output) 30 V DC max., 50 mA max.	Not provided.		
Insulation resistance	20 MΩ min. (at 500 V DC) between AC external and GR terminals (See note 3.)	20 MΩ min. (at 500 V DC) between all external terminals and GR terminal, and between all alarm output terminals. 20 MΩ min. (at 250 V DC) between all alarm output terminals and GR terminal.	20 MΩ min. (at 500 V DC) between AC external and GR terminals (See note 3.)	20 MΩ min. (at 500 V DC) between DC external and GR terminals (See note 3.)	--- (See note 6.)
Dielectric strength (See note 4.)	2,300 V AC 50/60 Hz for 1 min between AC external and GR terminals (See note 3.) Leakage current: 10 mA max.	2,300 V AC, 50/60 Hz for 1 minute between AC external terminals and GR terminal with a leakage current of 10 mA max. 1,000 V AC, 50/60 Hz for 1 minute between all alarm output terminals with a leakage current of 10 mA max.	2,300 V AC 50/60 Hz for 1 min between AC external terminals and GR terminal with a leakage current of 10 mA max. (See note 3.)	1,000 V AC 50/60 Hz for 1 min between DC external terminals and GR terminal with a leakage current of 10 mA max. (See note 3.)	--- (See note 6.)
	1,000 V AC 50/60 Hz for 1 min between DC external and GR terminals (See note 3.), Leakage current: 10 mA max.				
Noise immunity	2 kV on power supply line (conforming to IEC61000-4-4)				

Item	Specifications		
Vibration resistance	10 to 57 Hz, 0.075-mm amplitude, 57 to 150 Hz, acceleration: 9.8 m/s <sup>2</sup> in X, Y, and Z directions for 80 minutes (Time coefficient: 8 minutes × coefficient factor 10 = total time 80 min.)		
Shock resistance	147 m/s <sup>2</sup> 3 times each in X, Y, and Z directions (Relay Output Unit: 100 m/s <sup>2</sup> )		
Ambient operating temperature	0 to 55°C		
Ambient operating humidity	10% to 90% (with no condensation)	10% to 90% (with no condensation) (See note 5.)	10% to 90% (with no condensation)
Atmosphere	Must be free from corrosive gases.		
Ambient storage temperature	-20 to 75°C (excluding battery)	-20 to 75°C (See note 5.)	-20 to 75°C (excluding battery)
Grounding	Ground to less than 100 Ω		
Enclosure	Mounted in a panel.		
Weight	All Racks are each 5 kg max.		
Safety measures	Conforms to cULus and EC Directives.		

- Note**
1. The inrush current is given for a cold start at room temperature for AC Power Supply Units and for a cold start for DC Power Supply Units. The inrush control circuit uses a thermistor element with a low-temperature current control characteristic. If the ambient temperature is high or the NSJ Controller is hot-started, the thermistor will not be sufficiently cool, and the inrush currents given in the table may be exceeded by up to twice the given values. When selecting fuses or breakers for external circuits, allow sufficient margin in shut-off performance.  
A delay circuit that charges a capacitor is used to limit the inrush current in DC Power Supply Units. If a hot start is performed when the power supply has been OFF only a short period of time, the capacitor will still be charged and the inrush current specified above will be exceeded by up to approximately twice the specified value.
  2. Disconnect the Power Supply Unit's LG terminal from the GR terminal when testing insulation and dielectric strength. Testing the insulation and dielectric strength with the LG terminal and the GR terminals connected will damage internal circuits in the NSJ Controller.
  3. Change the applied voltage gradually using the adjuster on the Tester. If the full dielectric strength voltage is applied or turned OFF using the switch on the Tester, the generated impulse voltage may damage the Power Supply Unit.
  4. Maintain an ambient storage temperature of -25 to 30°C and an ambient humidity of 25% to 70% when storing the Unit for longer than 3 months to keep the replacement notification function in optimum working condition.
  5. CJ1W-PD022 is not insulated between the primary DC power and secondary DC power.

### 3-1-2 Performance Specifications

#### Controller Section

Model	I/O bits	User program memory (See note.)	Data Memory	Extended Data Memory	Function blocks		Flash memory													
					Max. No. of definitions	Max. No. of instances	FB program memory	Comment file	Program index file	Symbol table										
NSJ5-TQ00-G5D NSJ5-TQ00B-G5D NSJ5-TQ01-G5D NSJ5-TQ01B-G5D	1,280	60 Ksteps	32 Kwords	32 Kwords x 3 banks E0_000 00 to E2_327 67	1,024	2,048	1,024 Kbytes	64 Kbytes	64 Kbytes	128 Kbytes										
NSJ5-SQ00-G5D NSJ5-SQ00B-G5D NSJ5-SQ01-G5D NSJ5-SQ01B-G5D																				
NSJ5-TQ10-G5D NSJ5-TQ10B-G5D NSJ5-TQ11-G5D NSJ5-TQ11B-G5D																				
NSJ5-SQ10-G5D NSJ5-SQ10B-G5D NSJ5-SQ11-G5D NSJ5-SQ11B-G5D																				
NSJ8-TV00-G5D NSJ8-TV00B-G5D NSJ8-TV01-G5D NSJ8-TV01B-G5D																				
NSJ10-TV00-G5D NSJ10-TV00B-G5D NSJ10-TV01-G5D NSJ10-TV01B-G5D																				
NSJ12-TS00-G5D NSJ12-TS00B-G5D NSJ12-TS01-G5D NSJ12-TS01B-G5D																				
NSJ5-TQ00-M3D NSJ5-TQ00B-M3D NSJ5-TQ01-M3D NSJ5-TQ01B-M3D											640	20 Ksteps		None	128	256	256 Kbytes			64 Kbytes
NSJ5-SQ00-M3D NSJ5-SQ00B-M3D NSJ5-SQ01-M3D NSJ5-SQ01B-M3D																				
NSJ5-TQ10-M3D NSJ5-TQ10B-M3D NSJ5-TQ11-M3D NSJ5-TQ11B-M3D																				
NSJ5-SQ10-M3D NSJ5-SQ10B-M3D NSJ5-SQ11-M3D NSJ5-SQ11B-M3D																				
NSJ8-TV00-M3D NSJ8-TV00B-M3D NSJ8-TV01-M3D NSJ8-TV01B-M3D																				

**Note** The number of steps in a program is not the same as the number of instructions. Each instruction requires from 1 to 7 steps. For example, LD and OUT

require 1 step each, but MOV(021) requires 3 steps. The program capacity indicates the total number of steps for all instructions in the program. Refer to 10-4 Instruction Execution Times and Number of Steps in the CJ Series Setup Manual for the number of steps required for each instruction.

**Display Section**

Model	Display panel (See note 5.)					Backlight (See note 1.)		
	Display device	Effective area	Number of dots	Display color	View angle	Life expectancy (See note 2.)	Brightness adjustment (See note 3.)	Backlight error detection (See note 4.)
NSJ5-TQ00-G5D	High-luminance TFT color LCD (See note 6.)	117.2 × 88.4 mm (W × H) (5.7 inches)	320 × 240 (QVGA)	256 colors (32,768 colors for BMP/JPEG images)	Left 70°, Right 70°, Top 70°, Bottom 50°	75,000 hours min.	There are 3 levels of adjustment by operating the touch panel.	Error is detected automatically, and the RUN indicator flashes green for notification.
NSJ5-TQ00B-G5D								
NSJ5-TQ01-G5D								
NSJ5-TQ01B-G5D								
NSJ5-TQ00-M3D								
NSJ5-TQ00B-M3D								
NSJ5-TQ01-M3D								
NSJ5-TQ01B-M3D								
NSJ5-TQ10-G5D								
NSJ5-TQ10B-G5D								
NSJ5-TQ11-G5D								
NSJ5-TQ11B-G5D								
NSJ5-TQ10-M3D								
NSJ5-TQ10B-M3D								
NSJ5-TQ11-M3D								
NSJ5-TQ11B-M3D								
NSJ5-SQ00-G5D	STN color LCD	115.2 × 86.4 mm (W × H) (5.7 inches)		256 colors (4,096 colors for BMP/JPEG images)	Left 50°, Right 50°, Top 45°, Bottom 50°	75,000 hours min.	There are 3 levels of adjustment by operating the touch panel.	
NSJ5-SQ00B-G5D								
NSJ5-SQ01-G5D								
NSJ5-SQ01B-G5D								
NSJ5-SQ00-M3D								
NSJ5-SQ00B-M3D								
NSJ5-SQ01-M3D								
NSJ5-SQ01B-M3D								
NSJ5-SQ10-G5D	TFT color LCD	115.2 × 86.4 mm (W × H) (5.7 inches)		256 colors (32,768 colors for BMP/JPEG images)	Left 80°, Right 80°, Top 80°, Bottom 60°	75,000 hours min.	There are 3 levels of adjustment by operating the touch panel. (See note 7.)	
NSJ5-SQ10B-G5D								
NSJ5-SQ11-G5D								
NSJ5-SQ11B-G5D								
NSJ5-SQ10-M3D								
NSJ5-SQ10B-M3D								
NSJ5-SQ11-M3D								
NSJ5-SQ11B-M3D								

Model	Display panel (See note 5.)					Backlight (See note 1.)		
	Display device	Effective area	Number of dots	Display color	View angle	Life expectancy (See note 2.)	Brightness adjustment (See note 3.)	Backlight error detection (See note 4.)
NSJ8-TV00-G5D	High-definition TFT color LCD	170.9 × 128.2 mm (W × H) (8.4 inches)	640 × 480 (VGA)	256 colors (32,768 colors for BMP/JPEG images)	Left 65°, Right 65°, Top 50°, Bottom 60°	50,000 hours min.	There are 3 levels of adjustment by operating the touch panel.	Error is detected automatically, and the RUN indicator flashes green for notification.
NSJ8-TV00B-G5D								
NSJ8-TV01-G5D								
NSJ8-TV01B-G5D								
NSJ8-TV00-M3D								
NSJ8-TV00B-M3D								
NSJ8-TV01-M3D								
NSJ8-TV01B-M3D								
NSJ10-TV00-G5D	215.2 × 162.4 mm (W × H) (10.4 inches)	800 × 600 (QVGA)	256 colors (32,768 colors for BMP/JPEG images)	Left 60°, Right 60°, Top 35°, Bottom 65°	50,000 hours min.	There are 3 levels of adjustment by operating the touch panel.	Error is detected automatically, and the RUN indicator flashes green for notification.	
NSJ10-TV00B-G5D								
NSJ10-TV01-G5D								
NSJ10-TV01B-G5D								
NSJ12-TS00-G5D	246.0 × 184.5 mm (W × H) (12.1 inches)	800 × 600 (QVGA)	256 colors (32,768 colors for BMP/JPEG images)	Left 60°, Right 60°, Top 45°, Bottom 75°	50,000 hours min.	There are 3 levels of adjustment by operating the touch panel.	Error is detected automatically, and the RUN indicator flashes green for notification.	
NSJ12-TS00B-G5D								
NSJ12-TS01-G5D								
NSJ12-TS01B-G5D								

- Note**
- (1) Contact your nearest OMRON representative to replace the backlight.
  - (2) This is the estimated time before brightness is reduced by half at room temperature and humidity. It is not a guaranteed value. The life expectancy will be drastically shortened if the NSJ Controller is used at low temperatures. For example, use at temperatures of 0°C will reduce the life expectancy to approximately 10,000 hours (reference value).
  - (3) The brightness cannot be adjusted much.
  - (4) This function does not detect service life expectancy. It detects when the backlight is not lit due to a disconnection or other errors. Backlight error detection indicates that all backlights (2) are OFF.
  - (5) There are sometimes faulty pixels in the touch panel of the Display Section, but this does not indicate an error as long as the number of bright or dark pixels does not exceed the following limits.

Model	Limit
NSJ12-TS□□(B)-□□□□ NSJ10-TV□□(B)-□□□□ NSJ8-TV□□(B)-□□□□	10 bright or dark pixels max. with no more than 3 contiguous defective pixels.
NSJ5-□Q□□(B)-□□□□	4 total defects max. of the following size with no more than one per 20-mm square: 0.2 mm < (short dia. + long dia.)/2 ≤ 0.55 mm

- (6) The NSJ5-TQ Controllers (high-luminance TFT LCDs) are approx. 40 cd/m<sup>2</sup> brighter than the NSJ5-SQ1□ Controllers (TFT LCDs).
- (7) There are only 3 levels for lot number 14Z0 or earlier.

Other Display Section Specifications

Model	Touch panel (matrix type)				Standard screen data capacity	Built-in USB slave port	Built-in RS-232C port	Built-in Ethernet	Built-in USB printer port	Language	Frame color
	Method	Number of switches	Input	Service life							
NSJ5-TQ00-M3D	Resistive membrane	300 (20 horizontal x 15 vertical) 16 x 16 dots for each switch	Pressure-sensitive	1,000,000 touch operations.	20 MB	1 port	3 ports (Display Section: A and B, Controller Section: C)	None	None	Japanese and English	Ivory
NSJ5-TQ00-G5D											Black
NSJ5-TQ00B-M3D											Ivory
NSJ5-TQ00B-G5D											Black
NSJ5-TQ01-M3D											Ivory
NSJ5-TQ01-G5D											Black
NSJ5-TQ01B-M3D											Ivory
NSJ5-TQ01B-G5D											Black
NSJ5-SQ00-M3D											Ivory
NSJ5-SQ00-G5D											Black
NSJ5-SQ00B-M3D											Ivory
NSJ5-SQ00B-G5D											Black
NSJ5-SQ01-M3D											Ivory
NSJ5-SQ01-G5D											Black
NSJ5-SQ01B-M3D											Ivory
NSJ5-SQ01B-G5D											Black
NSJ5-TQ10-M3D					60 MB			Ivory			
NSJ5-TQ10-G5D								Black			
NSJ5-TQ10B-M3D								Ivory			
NSJ5-TQ10B-G5D								Black			
NSJ5-TQ11-M3D								Ivory			
NSJ5-TQ11-G5D								Black			
NSJ5-TQ11B-M3D								Ivory			
NSJ5-TQ11B-G5D								Black			
NSJ5-SQ10-M3D								Ivory			
NSJ5-SQ10-G5D								Black			
NSJ5-SQ10B-M3D								Ivory			
NSJ5-SQ10B-G5D								Black			
NSJ5-SQ11-M3D								Ivory			
NSJ5-SQ11-G5D								Black			
NSJ5-SQ11B-M3D								Ivory			
NSJ5-SQ11B-G5D								Black			
NSJ8-TV00-M3D	768 (32 horizontal x 24 vertical) 20 x 20 dots for each switch				60 MB			None	1 port	Ivory	
NSJ8-TV00-G5D										Black	
NSJ8-TV00B-M3D										Ivory	
NSJ8-TV00B-G5D										Black	
NSJ8-TV01-M3D								Ivory			
NSJ8-TV01-G5D								Black			
NSJ8-TV01B-M3D								Ivory			
NSJ8-TV01B-G5D								Black			
NSJ10-TV00-G5D	1,200 (40 horizontal x 30 vertical) 16 x 16 dots for each switch							None		Ivory	
NSJ10-TV00B-G5D										Black	
NSJ10-TV01-G5D										Ivory	
NSJ10-TV01B-G5D										Black	
NSJ12-TS00-G5D	1,900 (50 horizontal x 58 vertical) 16 x 16 dots for each switch							None		Ivory	
NSJ12-TS00B-G5D										Black	
NSJ12-TS01-G5D										Ivory	
NSJ12-TS01B-G5D										Black	

**Built-in Serial Ports**

Port	Description
USB slave port (for Programming Device connection)	Can be connected to a computer running the CX-Programmer or CX-Designer. Set the network type to "USB."
Serial port C (on Controller Section)	Serial communications modes: Toolbus, Host Link, Non-protocol, NT Link, or Serial Gateway
Serial ports A and B (on Display Section)	Serial communications modes: Toolbus, Host Link, Non-protocol (barcode reader only), NT Link, or CompoWay/F (Temperature Controller.)

**Built-in Ethernet Port**

Port	Description
Built-in Ethernet port	<ul style="list-style-type: none"> <li>• FINS message communications (send and receive)</li> <li>• FTP server (Accesses Memory Card in Display Section.)</li> </ul>

**Common Specifications**

**Controller Section**

Item	Specifications	Reference
<b>Control method</b>	Stored program	---
<b>I/O control method</b>	Cyclic scan and immediate processing are both possible.	---
<b>Programming</b>	Ladder diagram	---
<b>CPU processing mode</b>	Normal Mode, Parallel Processing Mode with Asynchronous Memory Access, Parallel Processing Mode with Synchronous Memory Access, or Peripheral Servicing Priority Mode	---
<b>Instruction length</b>	1 to 7 steps per instruction	<i>CJ Series Operation Manual (W393): 10-5 Instruction Execution Times and Number of Steps</i>
<b>Ladder instructions</b>	Approx. 400 (3-digit function codes)	---
<b>Execution time</b>	Basic instructions: 0.04 μs min. Special instructions: 0.06 μs min.	<i>CJ Series Operation Manual (W393): 10-5 Instruction Execution Times and Number of Steps</i>
<b>Overhead time</b>	Normal mode: 0.3 ms min. Parallel processing: 0.3 ms min.	---
<b>Mounting method</b>	Mounted using Panel Mounting Bracket.	This manual: 5-1-3 <i>Mounting the NSJ Controller to the Control Panel</i>
<b>Mountable Expansion Units</b>	One of the following Units can be mounted. NSJ I/O Control Unit (NSJW-IC101) NSJ Controller Link Unit (NSJW-CLK21-V1) NSJ Ethernet Unit (NSJW-ETN21)	This manual: 3-2 <i>System Configuration</i>
<b>Number of Expansion Racks</b>	One CJ-series Expansion Rack can be connected to the NSJ□-□□□□-M3D and up to three CJ-series Expansion Racks can be connected to all other NSJ Controllers by mounting an NSJ I/O Control Unit (NSJW-IC101).  Each Expansion Rack requires an CJ-series I/O Interface Unit (CJ1W-II101) and a Power Supply Unit.	<i>CJ Series Operation Manual (W393): 2-3-3 CJ-series Expansion Racks</i>



Item	Specifications	Reference
<b>Connectable Units</b>	Per Expansion Rack: 10 Units including Basic I/O Units, Special I/O Units, and CPU Bus Units. NSJ□-□□□□-G5D: Total per NSJ Controller: 10 Units on each of 3 Expansion Racks = 30 Units total NSJ□-□□□□-M3D: Total per NSJ Controller: 10 Units on one Expansion Rack = 10 Units total	<i>CJ Series Operation Manual (W393): 2-3-3</i> <i>CJ-series Expansion Racks</i>
<b>Number of tasks</b>	288 (cyclic tasks: 32, interrupt tasks: 256) Interrupt tasks can be defined as cyclic tasks called "extra cyclic tasks." Including these, up to 288 cyclic tasks can be used. <b>Note 1</b> Cyclic tasks are executed each cycle and are controlled with TKON(820) and TKOF(821) instructions. <b>Note 2</b> The following 3 types of interrupt tasks are supported. Power OFF interrupt tasks: 1 max. Scheduled interrupt tasks: 2 max. External interrupt tasks: 256 max.	<i>CS/CJ Series Programming Manual (W394): 1-3 Programs and Tasks and SECTION 4: Tasks</i>
<b>Interrupt types</b>	Scheduled Interrupts: Interrupts generated at a time scheduled by the Controller Section's built-in timer. (See note. 1) Power OFF Interrupts (See note 2.): Interrupts executed when the Controller Section's power is turned OFF. External I/O Interrupts: Interrupts from the Special I/O Units or CPU Bus Units. <b>Note 1</b> Scheduled interrupt time interval is either 1 ms to 9,999 ms or 10 ms to 99,990 ms, in units of 1 ms or 10 ms. <b>Note 2</b> Not supported when the CJ1W-PD022 Power Supply Unit is mounted.	<i>CS/CJ Series Programming Manual (W394): 4-3 Interrupt Tasks</i>
<b>Calling subroutines from more than one task</b>	Supported (called "global subroutines").	<i>CS/CJ Series Programming Manual (W394): 4-2-5 Global Subroutines</i>
<b>Function blocks</b>	Languages in function block definitions: ladder programming, structured text	<i>CX-Programmer Ver. 6.□ CS1-H, CJ1-H, CJ1M CPU Units Operation Manual Function Blocks (W438)</i>

Item	Specifications	Reference
<b>Connectable Units</b>	Per Expansion Rack: 10 Units including Basic I/O Units, Special I/O Units, and CPU Bus Units. NSJ□-□□□□-G5D: Total per NSJ Controller: 10 Units on each of 3 Expansion Racks = 30 Units total NSJ□-□□□□-M3D: Total per NSJ Controller: 10 Units on one Expansion Rack = 10 Units total	<i>CJ Series Operation Manual (W393): 2-3-3 CJ-series Expansion Racks</i>
<b>Number of tasks</b>	288 (cyclic tasks: 32, interrupt tasks: 256) Interrupt tasks can be defined as cyclic tasks called "extra cyclic tasks." Including these, up to 288 cyclic tasks can be used. <b>Note 1</b> Cyclic tasks are executed each cycle and are controlled with TKON(820) and TKOF(821) instructions. <b>Note 2</b> The following 3 types of interrupt tasks are supported. Power OFF interrupt tasks: 1 max. Scheduled interrupt tasks: 2 max. External interrupt tasks: 256 max.	<i>CS/CJ Series Programming Manual (W394): 1-3 Programs and Tasks and SECTION 4: Tasks</i>
<b>Interrupt types</b>	Scheduled Interrupts: Interrupts generated at a time scheduled by the Controller Section's built-in timer. (See note. 1) Power OFF Interrupts (See note 2.): Interrupts executed when the Controller Section's power is turned OFF. External I/O Interrupts: Interrupts from the Special I/O Units or CPU Bus Units. <b>Note 1</b> Scheduled interrupt time interval is either 1 ms to 9,999 ms or 10 ms to 99,990 ms, in units of 1 ms or 10 ms. <b>Note 2</b> Not supported when the CJ1W-PD022 Power Supply Unit is mounted.	<i>CS/CJ Series Programming Manual (W394): 4-3 Interrupt Tasks</i>
<b>Calling subroutines from more than one task</b>	Supported (called "global subroutines").	<i>CS/CJ Series Programming Manual (W394): 4-2-5 Global Subroutines</i>
<b>Function blocks</b>	Languages in function block definitions: ladder programming, structured text	<i>CX-Programmer Ver. 6.□ CS1-H, CJ1-H, CJ1M CPU Units Operation Manual Function Blocks (W438)</i>

Item	Specifications		Reference													
<b>CIO (Core I/O) Area</b>	<b>I/O Area</b>	2,560 (160 words): CIO 00000 to CIO 015915 (80 words from CIO 0000 to CIO 0159)  The setting of the first word can be changed from the default (CIO 0000) so that CIO 0000 to CIO 0999 can be used.  I/O bits are allocated to Basic I/O Units.	The CIO Area can be used as work bits if the bits are not used as shown here.	<i>CJ Series Operation Manual (W393):9-3 I/O Area</i>												
	<b>Link Area</b>	3,200 (200 words): CIO 10000 to CIO 119915 (words CIO 1000 to CIO 1199)		<i>CJ Series Operation Manual (W393):9-4 Data Link Area and 2-5-3 Communications Network System</i>  <i>Controller Link Unit Operation Manual (W309)</i>												
	<b>CPU Bus Unit Area</b>	6,400 (400 words): CIO 150000 to CIO 189915 (words CIO 1500 to CIO 1899)  CPU Bus Unit bits store the operating status of CPU Bus Units (25 words per Unit, 16 Units max.).		<i>CJ Series Operation Manual (W393):9-5 CPU Bus Unit Area</i>  <i>Operation Manual for each CPU Bus Unit</i>												
	<b>Inner Board Area</b>	1,600 (100 words): CIO 190000 to CIO 199915 (words CIO 1900 to CIO 1999)  Inner Board bits are allocated to storing Display Section Status		---												
	<b>Special I/O Unit Area</b>	15,360 (960 words): CIO 200000 to CIO 295915 (words CIO 2000 to CIO 2959)  Special I/O Unit bits are allocated to Special I/O Units (10 words per Unit, 96 Units max.).		<i>CJ Series Operation Manual (W393):9-6 Special I/O Unit Area</i>  <i>Operation Manual for each Special I/O Unit</i>												
<b>CIO (Core I/O) Area</b>	<b>DeviceNet Area</b>	9,600 (600 words): CIO 320000 to CIO 379915 (words CIO 3200 to CIO 3799)  DeviceNet bits are allocated to Slaves for DeviceNet Section remote I/O communications when the master is used with fixed allocations. <table border="1" data-bbox="427 1229 1023 1421"> <tr> <td>Fixed allocation setting 1</td> <td>Outputs: CIO 3200 to CIO 3263 Inputs: CIO 3300 to CIO 3363</td> </tr> <tr> <td>Fixed allocation setting 2</td> <td>Outputs: CIO 3400 to CIO 3463 Inputs: CIO 3500 to CIO 3563</td> </tr> <tr> <td>Fixed allocation setting 3</td> <td>Outputs: CIO 3600 to CIO 3663 Inputs: CIO 3700 to CIO 3763</td> </tr> </table> <p>The following words are allocated in the master when the DeviceNet Section is used as a slave with fixed allocations.</p> <table border="1" data-bbox="427 1538 1023 1725"> <tr> <td>Fixed allocation setting 1</td> <td>Outputs: CIO 3370 (Master to Slave) Inputs: CIO 3270 (Slave to Master)</td> </tr> <tr> <td>Fixed allocation setting 2</td> <td>Outputs: CIO 3570 (Master to Slave) Inputs: CIO 3470 (Slave to Master)</td> </tr> <tr> <td>Fixed allocation setting 3</td> <td>Outputs: CIO 3770 (Master to Slave) Inputs: CIO 3670 (Slave to Master)</td> </tr> </table>	Fixed allocation setting 1	Outputs: CIO 3200 to CIO 3263 Inputs: CIO 3300 to CIO 3363	Fixed allocation setting 2	Outputs: CIO 3400 to CIO 3463 Inputs: CIO 3500 to CIO 3563	Fixed allocation setting 3	Outputs: CIO 3600 to CIO 3663 Inputs: CIO 3700 to CIO 3763	Fixed allocation setting 1	Outputs: CIO 3370 (Master to Slave) Inputs: CIO 3270 (Slave to Master)	Fixed allocation setting 2	Outputs: CIO 3570 (Master to Slave) Inputs: CIO 3470 (Slave to Master)	Fixed allocation setting 3	Outputs: CIO 3770 (Master to Slave) Inputs: CIO 3670 (Slave to Master)	The CIO Area can be used as work bits if the bits are not used as shown here.	<i>DeviceNet Unit Operation Manual (W380)</i>  <i>CJ Series Operation Manual (W393): 9-7 DeviceNet Area</i>
		Fixed allocation setting 1	Outputs: CIO 3200 to CIO 3263 Inputs: CIO 3300 to CIO 3363													
Fixed allocation setting 2	Outputs: CIO 3400 to CIO 3463 Inputs: CIO 3500 to CIO 3563															
Fixed allocation setting 3	Outputs: CIO 3600 to CIO 3663 Inputs: CIO 3700 to CIO 3763															
Fixed allocation setting 1	Outputs: CIO 3370 (Master to Slave) Inputs: CIO 3270 (Slave to Master)															
Fixed allocation setting 2	Outputs: CIO 3570 (Master to Slave) Inputs: CIO 3470 (Slave to Master)															
Fixed allocation setting 3	Outputs: CIO 3770 (Master to Slave) Inputs: CIO 3670 (Slave to Master)															
<b>Internal I/O Area</b>	4,800 (300 words): CIO 120000 to CIO 149915 (words CIO 1200 to CIO 1499)  37,504 (2,344 words): CIO 380000 to CIO 614315 (words CIO 3800 to CIO 6143)  These bits in the CIO Area are used as work bits in programming to control program execution. They cannot be used for external I/O.	<i>CJ Series Operation Manual (W393): 9-2-2 Overview of the Data Areas</i>														

Item	Specifications	Reference
<b>Work Area</b>	8,192 bits (512 words): W00000 to W51115 (W000 to W511) Controls the programs only. (I/O from external I/O terminals is not possible.)  <b>Note</b> When using work bits in programming, use the bits in the Work Area first before using bits from other areas.	<i>CJ Series Operation Manual (W393): 9-2-2 Overview of the Data Areas and 9-7 Serial PLC Link Area</i>
<b>Holding Area</b>	8,192 bits (512 words): H00000 to H51115 (H000 to H511) Holding bits are used to control the execution of the program, and maintain their ON/OFF status when the NSJ Controller is turned OFF or the operating mode is changed.  <b>Note</b> The Function Block Holding Area words are allocated from H512 to H1535. These words can be used only for the function block instance area (internally allocated variable area).	<i>CJ Series Operation Manual (W393): 9-2-2 Overview of the Data Areas and 9-10 Holding Area</i>
<b>Auxiliary Area</b>	Read-only: 7,168 bits (448 words): A00000 to A44715 (words A000 to A447) Read/write: 8,192 bits (512 words): A44800 to A95915 (words A448 to A959) Auxiliary bits are allocated specific functions.	<i>CJ Series Operation Manual (W393): 9-2-2 Overview of the Data Areas and 9-11 Auxiliary Area</i>
<b>Temporary Area</b>	16 bits (TR0 to TR15) Temporary bits are used to temporarily store the ON/OFF execution conditions at program branches.	<i>CJ Series Operation Manual (W393): 9-2-2 Overview of the Data Areas and 9-12 TR (Temporary Relay) Area</i>
<b>Timer Area</b>	4,096: T0000 to T4095 (used for timers only)	<i>CJ Series Operation Manual (W393): 9-2-2 Overview of the Data Areas and 9-13 Timer Area</i>
<b>Counter Area</b>	4,096: C0000 to C4095 (used for counters only)	<i>CJ Series Operation Manual (W393): 9-2-2 Overview of the Data Areas and 9-14 Counter Area</i>
<b>DM Area</b>	32 Kwords: D00000 to D32767 Used as a general-purpose data area for reading and writing data in word units (16 bits). Words in the DM Area maintain their status when the NSJ Controller is turned OFF or the operating mode is changed. Internal Special I/O Unit DM Area: D20000 to D29599 (100 words × 96 Units) Used to set parameters for Special I/O Units. CPU Bus Unit DM Area: D30000 to D31599 (100 words × 16 Units) Used to set parameters for CPU Bus Units.	<i>CJ Series Operation Manual (W393): 9-2-2 Overview of the Data Areas and 9-15 Data Memory (DM) Area</i>
<b>EM Area</b>	NSJ□-□□□□-G5D 32 Kwords per bank, 3 banks max.: E0_00000 to E2_32767 max. Used as a general-purpose data area for reading and writing data in word units (16 bits). Words in the EM Area maintain their status when the NSJ Controller is turned OFF or the operating mode is changed. The EM Area is divided into banks, and the addresses can be set by either of the following methods. Changing the current bank using the EMBC(281) instruction and setting addresses for the current bank. Setting bank numbers and addresses directly. EM data can be stored in files by specifying the number of the first bank.  NSJ□-□□□□-M3D Not supported.	<i>CJ Series Operation Manual (W393): 9-2-2 Overview of the Data Areas and 9-16 Extended Data Memory (EM) Area</i>

Item	Specifications	Reference
<b>Index Registers</b>	IR0 to IR15 Store actual memory addresses for indirect addressing. Index registers can be used independently in each task. One register is 32 bits (2 words).	<i>CJ Series Operation Manual (W393): 9-17 Index Registers</i> <i>CS/CJ Series Programming Manual (W394): 6-2 Index Registers</i>
<b>Task Flag Area</b>	32 (TK0000 to TK0031) Task Flags are read-only flags that are ON when the corresponding cyclic task is executable and OFF when the corresponding task is not executable or in standby status.	<i>CJ Series Operation Manual (W393): 9-19 Task Flags</i> <i>CS/CJ Series Programming Manual (W393): 4-2-3 Flags Related to Cyclic Tasks</i>
<b>Trace Memory</b>	4,000 words (trace data: 31 bits, 6 words)	<i>CS/CJ Series Programming Manual (W394): 7-2-4 Tracing Data</i>
<b>File Memory</b>	Memory Cards: OMRON Memory Cards can be used (MS-DOS format). EM file memory: Part of the EM Area can be converted to file memory (MS-DOS format). The NSJ□-□□□□-M3D does not support the use of EM file memory.	<i>CS/CJ Series Programming Manual (W394): SECTION 5: File Memory Functions</i>

**Function Specifications**

Item	Specifications	Reference
<b>Constant cycle time</b>	1 to 32,000 ms (Unit: 1 ms) When a Parallel Processing Mode is used, the cycle time for executing instructions is constant.	<i>CJ Series Operation Manual (W393): 10-4 Computing the Cycle Time</i> <i>CS/CJ Series Programming Manual (W394): 6-1-1 Minimum Cycle Time</i>
<b>Cycle time monitoring</b>	Possible (Unit stops operating if the cycle is too long): 10 to 40,000 ms (Unit: 10 ms) When a Parallel Processing Mode is used, the instruction execution cycle is monitored. Controller Section operation will stop if the peripheral servicing cycle time exceeds 2 s (fixed).	<i>CJ Series Operation Manual (W393): 10-4 Computing the Cycle Time</i> <i>CS/CJ Series Programming Manual (W394): 6-1-2 Maximum Cycle Time (Watch Cycle Time) and 6-1-3 Cycle Time Monitoring</i>
<b>I/O refreshing</b>	Cyclic refreshing, immediate refreshing, refreshing by IORF(097). IORF(097) refreshes I/O bits allocated to Basic I/O Units and Special I/O Units. The CPU BUS UNIT I/O REFRESH (DLNK(226)) instruction can be used to refresh bits allocated to CPU Bus Units in the CIO and DM Areas.	<i>CJ Series Operation Manual (W393): 10-4 Computing the Cycle Time</i> <i>CS/CJ Series Programming Manual (W394): 6-1-6 I/O Refresh Methods</i>
<b>Timing of special refreshing for CPU Bus Units</b>	Data links for Controller Link, remote I/O for DeviceNet, and other special refreshing for CPU Bus Units is performed during the I/O refresh period and when the CPU BUS UNIT I/O REFRESH (DLNK(226)) instruction is executed.	<i>CJ Series Operation Manual (W393): 10-4 Computing the Cycle Time</i>

Item	Specifications	Reference
<b>I/O memory holding when changing operating modes</b>	Depends on the ON/OFF status of the IOM Hold Bit in the Auxiliary Area.	<i>CJ Series Operation Manual (W393): SECTION 9 Memory Areas and 9-2-3 Data Area Properties</i> <i>CS/CJ Series Programming Manual (W394): 6-4-1 Hot Start/Cold Start Function</i>
<b>Load OFF</b>	All outputs on Output Units can be turned OFF when the Controller Section is operating in RUN, MONITOR, or PROGRAM mode.	<i>CS/CJ Series Programming Manual (W394): 6-5-2 Load OFF Function and 7-2-3 Online Editing</i>
<b>Timer/Counter PV refresh method</b>	BCD or binary (CX-Programmer Ver. 3.0 or higher).	<i>CS/CJ Series Programming Manual (W394): 6-4 Changing the Timer/Counter PV Refresh Mode</i>
<b>Input response time setting</b>	Time constants can be set for inputs from CJ-series Basic I/O Units. The time constant can be increased to reduce the influence of noise and chattering or it can be decreased to detect shorter pulses on the inputs.	<i>CJ Series Operation Manual (W393): 10-4-6 I/O Response Time</i> <i>CS/CJ Series Programming Manual (W394): 6-6-1 I/O Response Time Settings</i>
<b>Mode setting at startup</b>	Possible	<i>CJ Series Operation Manual (W393): 7-1-2 PLC Setup Settings</i> <i>CS/CJ Series Programming Manual (W394): 1-2 Operating Modes and 1-2-3 Startup Mode</i>
<b>Flash memory</b>	The user program and parameter area data (e.g., PLC Setup) are always backed up automatically in flash memory. (automatic backup and restore.)  When downloading projects from CX-Programmer Ver. 5.0 or higher, symbol table files (including CX-Programmer symbol names, I/O comments), comment files (CX-Programmer rung comments, other comments), and program index files (CX-Programmer section names, section comments, or program comments) are stored in comment memory within the flash memory.	---

Item	Specifications		Reference
<b>Memory Card functions (Controller Section)</b>	Automatically reading programs (autoboot) from the Memory Card when the power is turned ON.	Possible	<i>CJ Series Operation Manual (W393): 3-2 File Memory</i> <i>CS/CJ Series Programming Manual (W394): SECTION 5 File Memory Functions, 5-1-3 Files, and 5-2-2 CMND Instruction</i>
	Program replacement during Controller Section operation	Possible	<i>CS/CJ Series Programming Manual (W394): 5-2-3 Using Instruction in User Program</i>
	Format in which data is stored in Memory Card	User program: Program file format PLC Setup and other parameters: Data file format I/O memory: Data file format (binary format), text format, or CSV format	<i>CS/CJ Series Programming Manual (W394): 5-1 File Memory</i>
	Functions for which Memory Card read/write is supported	User program instructions, Programming Devices (e.g., CX-Programmer), Host Link computers, AR Area control bits, easy backup operation	<i>CS/CJ Series Programming Manual (W394): 5-2 File Memory Operations</i> This manual: 11-1 Backup Function
<b>Filing (Controller Section)</b>	Memory Card data and the EM (Extended Data Memory) Area can be handled as files.		<i>CS/CJ Series Programming Manual (W394): SECTION 5 File Memory Functions</i>
<b>Debugging</b>	Force-set/reset, differential monitoring, data tracing (scheduled, each cycle, or when instruction is executed), storing location generating error when a program error occurs.		<i>CS/CJ Series Programming Manual (W394): 7-2 Trial Operation and Debugging</i>
<b>Online editing</b>	User programs can be overwritten in program-block units when the Controller Section is in MONITOR or PROGRAM mode. This function is not supported for block programming areas. With the CX-Programmer, more than one program block can be edited at the same time.		<i>CS/CJ Series Programming Manual (W394): 1-2 Operating Modes and 7-2-3 Online Editing</i>
<b>Program protection</b>	Overwrite protection: Set using DIP switch or via password from Programming Device. Copy protection: Password set using CX-Programmer.		<i>CS/CJ Series Programming Manual (W394): 6-4-6 Program Protection</i>
<b>Error check</b>	User-defined errors (i.e., user can define fatal errors and non-fatal errors) The FPD(269) instruction can be used to check the execution time and logic of each programming block. FAL and FALS instructions can be used to simulate errors.		<i>CJ Series Operation Manual (W393): 11-2-5 Error Messages</i> <i>CS/CJ Series Programming Manual (W394): 6-5 Diagnostic Functions and 6-5-3 Failure Alarm Functions</i>
<b>Error log</b>	Up to 20 errors are stored in the error log. Information includes the error code, error details, and the time the error occurred. The Controller Section can be set so that user-defined FAL errors are not stored in the error log.		<i>CS/CJ Series Programming Manual (W394): 6-4-1 Error Log</i>

Item	Specifications	Reference
<b>Clock</b>	Provided on all models. Accuracy: Ambient temperature Monthly error 25°C -1.5 min to +1.5 min <b>Note</b> The accuracy will vary with the temperature. <b>Note</b> Used to store the time when power is turned ON and when errors occur.	<i>CS/CJ Series Programming Manual (W394): 6-4-5 Clock Functions</i>
<b>Power OFF detection time</b>	2 ms	<i>CJ Series Operation Manual (W393): 10-3 Power OFF Operation</i>
<b>Power OFF detection delay time</b>	0 ms (fixed)	<i>CS/CJ Series Programming Manual (W394): 6-4-4 Power OFF Detection Delay Time</i>
<b>Memory protection</b>	Held Areas: Holding bits, contents of Data Memory and Extended Data Memory, and status of the counter Completion Flags and present values. <b>Note</b> If the IOM Hold Bit in the Auxiliary Area is turned ON, and the PLC Setup is set to maintain the IOM Hold Bit status when power to the NSJ Controller is turned ON, the contents of the CIO Area, the Work Area, part of the Auxiliary Area, timer Completion Flag and PVs, Index Registers, and the Data Registers will be saved.	<i>CJ Series Operation Manual (W393): 9-2-3 Data Area Properties</i>
<b>Sending commands to a Host Link computer</b>	FINS commands can be sent to a computer connected via the Host Link System by executing Network Communications Instructions from the Controller Section.	<i>CJ Series Operation Manual (W393): 2-5-2 Systems</i>
<b>Remote programming and monitoring</b>	Host Link communications can be used for remote programming and remote monitoring through a Controller Link System or Ethernet network.	<i>CJ Series Operation Manual (W393): 2-5-3 Communications Network System</i> <i>CS/CJ Series Programming Manual (W394): 6-4-7 Remote Programming and Monitoring</i>
<b>Eight-level communications</b>	Host Link communications can be used for remote programming and remote monitoring from devices on networks up to eight levels away (Controller Link Network or Ethernet Network).	<i>CJ Series Operation Manual (W393): 2-5-2 Systems</i>
<b>Storing comments in Controller Section</b>	I/O comments can be stored as symbol table files in the Memory Card in the Controller Section, EM file memory, or comment memory (see note). <b>Note</b> Comment memory is supported for CX-Programmer version 5.0 or higher.	I/O comments: <i>CX-Programmer Ver. 5.0 Operation Manual (W437)</i> Storing comments in CPU Unit: <i>CS/CJ Series Programming Manual (W394)</i>
<b>Program check</b>	Program checks are performed at the beginning of operation for items such as no END instruction and instruction errors. CX-Programmer can also be used to check programs.	<i>CS/CJ Series Programming Manual (W394): 2-3 Checking Programs</i>
<b>Control output signals</b>	RUN output: The internal contacts will turn ON (close) while the Controller Section is operating (CJ1W-PA205R).	<i>CS/CJ Series Programming Manual (W394): 6-4-3 RUN Output</i>
<b>Battery life</b>	Refer to <i>11-3 Maintenance and Replacement Methods</i> . Battery Set: CJ1W-BAT01	This manual: <i>11-3-2 Battery Replacement</i>



Item	Specifications	Reference
<b>Self-diagnostics</b>	Controller Section errors (watchdog timer), I/O bus errors, memory errors, and battery errors.	<i>CJ Series Operation Manual (W393): 11-2-5 Error Messages</i> This manual: 6-1 PLC Setup and 10-2 NSJ Troubleshooter Function
<b>Other functions</b>	Storage of number of times power has been interrupted. (Stored in A514.)	<i>CJ Series Operation Manual (W393): 10-3 Power OFF Operation</i>

**Display Section Display Specifications**

Item	Specification
Functional objects	A total of 1,024 functional and fixed objects in frames or tables can be created for each screen. There are some functional objects, however, for which it is not possible to create more than one functional object for the same screen.
ON/OFF Buttons	<ul style="list-style-type: none"> <li>• Button shape Rectangle, circle, 2-light rectangle, select shape.</li> <li>• Button operation Momentary, alternate, SET, RESET.</li> </ul>
Word Buttons	<ul style="list-style-type: none"> <li>• Button type Rectangle, select shape.</li> <li>• Button operation Set value, increase/reduce value, display pop-up menu.</li> <li>• Numeral specifications Word, 2-word, real number</li> </ul>
Command Buttons	<ul style="list-style-type: none"> <li>• Button operation Screen switching, key buttons, pop-up screen control, system menu display, buzzer stop, no processing, video control-video capture, video control-contrast adjustment, video control-vision sensor console output, data control block, canceling authentication</li> </ul>
Bit lamps	<ul style="list-style-type: none"> <li>• Lamp type: Single-line circle, single-line rectangle, double-line circle, double-line rectangle, specify shape.</li> </ul>
Word lamps	<ul style="list-style-type: none"> <li>• Lamp type: Single-line circle, single-line rectangle, double-line circle, double-line rectangle, specify shape.</li> <li>• Color change Up to 10 colors.</li> </ul>
Numeral display and input objects	<ul style="list-style-type: none"> <li>• Number of display digits Up to 25. Integer part: Up to 15 digits Decimal fraction part: Up to 10 digits. (Decimal fraction display is available only when decimal display format has been selected and gradations have been set or when Real number has been selected for the storage format.)</li> <li>• Input method Keypad or Command Button.</li> </ul>
String display and input objects	<ul style="list-style-type: none"> <li>• Character display format ASCII code (Shift JIS), Unicode.</li> <li>• Number of characters Up to 256.</li> <li>• Input method Keypad, Command Button, bar code reader.</li> </ul>
Text objects	<ul style="list-style-type: none"> <li>• Fixed string display or indirect specification. (With indirect specification, either multibyte code or Unicode can be selected.)</li> <li>• Number of characters Up to 256.</li> <li>• Reference file format File name (8 characters) + .TXT</li> </ul>

Item	Specification
List selection objects	<ul style="list-style-type: none"> <li>• Reference file format File name (up to 8 characters) +.LST</li> <li>• Operations at list selection Display/no display of selected bar. Store selected line number to specified address. Store selected line character string to specified address.</li> <li>• Character display format ASCII code (Shift JIS), Unicode.</li> <li>• Number of characters per line Up to 256.</li> <li>• Maximum number of display lines 1,024.</li> </ul>
Thumbwheel switches	<ul style="list-style-type: none"> <li>• Number of displayable digits Integer part: Up to 15 digits Decimal fraction part: Up to 10 digits. (Decimal fraction input is enabled only when the display format is set to decimal and scaling is set, or when real number storage is set.)</li> <li>• Input method + and – Buttons.</li> </ul>
Analog meters	<ul style="list-style-type: none"> <li>• Display direction Up, down, left, right.</li> <li>• Incremental direction Clockwise, counterclockwise.</li> <li>• Shape Quarter circle, half circle, circle.</li> <li>• Display format Colored, needle.</li> </ul>
Level display objects	<ul style="list-style-type: none"> <li>• Display direction From bottom to top, top to bottom, right to left, left to right</li> <li>• Coloring 3 levels</li> </ul>
Broken-line graphs	<ul style="list-style-type: none"> <li>• Number of graph points per broken line Up to 1,000</li> <li>• Number of displayable graph lines per broken-line graph Up to 256</li> <li>• Number of groups per project Up to 16</li> <li>• Number of graph lines per group Up to 256</li> <li>• Data saved in history Up to 300,000 bytes</li> </ul>
Bitmaps	<ul style="list-style-type: none"> <li>• Displayable file formats BMP, JPEG (RLE and progressive jpeg are not supported.)</li> </ul>
Alarm/Event display objects	<ul style="list-style-type: none"> <li>• Display format Fixed character, flowing text</li> <li>• Maximum number of display objects 5,000</li> </ul>
Alarm/Event summary and history objects	<ul style="list-style-type: none"> <li>• Display data Current alarms/events, alarm/event history.</li> <li>• Maximum number of display objects 2,048 (for histories).</li> </ul>
Date objects	<ul style="list-style-type: none"> <li>• Date displayed on Display Section (year, month, day)</li> <li>• Display format: 45 types.</li> </ul>
Time objects	<ul style="list-style-type: none"> <li>• Time displayed on Display Section (hour, minute, seconds) (Synchronized to Controller Section clock.)</li> <li>• Display format: 8 types.</li> </ul>

Item	Specification
Data log graphs	<ul style="list-style-type: none"> <li>• Number of log points 1 to 50,000</li> <li>• Number of data logs per project Up to 100 groups</li> <li>• Number of logging points per project Up to 160,000 (NS5: 120,000 points)</li> <li>• Number of addresses that can be recorded to 1 group Up to 16</li> <li>• Number of addresses for standard logging Up to 50</li> <li>• Number of always logging points 50,000 max.</li> </ul>
Data Block Table	<ul style="list-style-type: none"> <li>• Maximum number of records Up to 1,000 lines</li> <li>• Maximum number of fields Up to 500 columns</li> <li>• Data Quantity for 1 Data Block 102,400 bytes</li> </ul>
Consecutive line drawing	<ul style="list-style-type: none"> <li>• Maximum number of coordinates Up to 128</li> </ul>
Graphic display (fixed)	<ul style="list-style-type: none"> <li>• Displayed at any position. Rectangle, circle, ellipse, line, polyline, polygon, sector, arc.</li> </ul>
Frames	<ul style="list-style-type: none"> <li>• Up to 10 can be created per screen.</li> <li>• Up to 256 functional objects can be created per frame page. However, a limit of 1,024 objects per screen applies, and this may restrict the number of objects per frame page.</li> </ul>
Tables	<ul style="list-style-type: none"> <li>• Number of tables Any number of tables can be created, as long as the total number of objects per screen does not exceed 1,024.</li> <li>• Horizontal Up to 30 columns</li> <li>• Vertical Up to 40 lines</li> <li>• Number of functional objects per table Up to 256</li> </ul>
Libraries	<ul style="list-style-type: none"> <li>• Up to 4,096 libraries can be registered.</li> </ul>
User screens	<ul style="list-style-type: none"> <li>• Up to 4,000 screens, including base and pop-up screens, can be created per project.</li> <li>• Up to 3 pop-up screens can be overlapped.</li> </ul>
Sheets	<ul style="list-style-type: none"> <li>• Up to 32 sheets can be created per project.</li> <li>• Up to 10 sheets can be set for layered display on standard screens.</li> <li>• Up to 1,024 functional and fixed objects, including those inside frames and tables, can be created per sheet.</li> </ul>
Number of label switches	<ul style="list-style-type: none"> <li>• Up to 16.</li> </ul>
Background screen files	<ul style="list-style-type: none"> <li>• Displayable file formats BMP, JPEG (RLE-format bmp files and progressive jpeg are not supported.)</li> </ul>
Background colors	256.
Project registration method	<ul style="list-style-type: none"> <li>Transfer from CX-Designer to Display Section using one of the following menu commands.</li> <li>• PT - Transfer - Transfer [Computer-&gt;PT]</li> <li>• PT - Transfer - Quick Transfer [Computer-&gt;PT]</li> <li>• PT - Transfer - Transfer Tool</li> </ul>

**Note** Refer to *Appendix 1 Specifications* in the *NS-Series PT Programming Manual (V073)* for other display element specifications and special features.

**DeviceNet Section Communications Specifications**

Item	Specifications			
Communications protocol	DeviceNet			
DeviceNet master/slave	Can function as master or slave.			
Connection forms (See note 1.)	Combination of multi-drop and T-branch connections (for trunk or branch lines)			
Terminating resistance	SW4 (TER) is used to connect/disconnect terminating resistance. The TER indicator lights when terminating resistance is connected.			
Baud rate	500 kbps, 250 kbps, or 125 kbps (Set via DIP switch.)			
Communications distances	Baud rate	Network length	Branch line length	Total branch line length
	500 kbps	100 m max.	6 m max.	39 m max.
	250 kbps	250 m max. (See note 2.)	6 m max.	78 m max.
	125 kbps	500 m max. (See note 2.)	6 m max.	156 m max.
Max. number of Slaves	63 Slaves			
Error control	CRC error check, node address redundancy check, scan list verification			
Cable	Special 5-wire cable (2 signal lines, 2 power lines, 1 shield line)			

- Note**
- (1) Terminating resistance is required at both ends of the trunk line.
  - (2) Keep the maximum network length to 100 m or less when using Thin Cables.

## Wired Controller Link Communications Specifications

Items	Specifications
Communications method	N:N token bus
Code	Manchester code
Modulation	Baseband code
Synchronization	Flag synchronization (conforms to HDLC frames)
Transmission path form	Multi-drop bus
Baud rate and maximum transmission distance	The maximum transmission distance varies with the baud rate as follows: 2 Mbps: 500 m 1 Mbps: 800 m 500 Kbps: 1 km
Media	Specified shielded twisted-pair cable Number of signal lines: 2, shield line: 1
Node connection method	NSJ Controller Link Unit: Connected via a special connector (included) PLC: Connected to a terminal block IBM PC/AT or compatible: Connected via a special connector (included)
Maximum number of nodes	32 or 62 nodes (See note 2.)
Communications functions	Data links and message service
Number of data link words	Transmission area per node: 1,000 words max. Data link area (send/receive words) per node NSJ Controller: 20,000 words CS/CJ Series: 20,000 words max. (unit Ver. 1.2 or later) 12,000 words max. (pre-Ver. 1.2) C200HX/HG/HE, CVM1/CV, CQM1H: 8,000 words max. Personal computer: 32,000 or 62,000 words max. (See note 2.)
Data link areas	Bit-access areas (IR, AR, LR, CIO), DM Area (DM), and extended DM Area (EM)
Message length	2,012 bytes max. (including the header)
RAS functions	Polling node backup function Self-diagnosis function (hardware checking at startup) Echoback test and broadcast test (using the FINS command) Watchdog timer Error log function

- Note**
- (1) At least one Repeater Unit (CS1W-RPT01) is required to construct networks that uses a node address higher than 32. The following Controller Link Units/Support Boards must also be used, and the Wired Network 62 Node Enable Bit of the DM Parameter Area software switch of all nodes must be turned ON (62 nodes max.).  
CS1W-CLK21-V1, CJ1W-CLK21-V1, 3G8F7-CLK21-V1, NSJW-CLK21-V1, CS1W-CLK23, CJ1W-CLK23, 3G8F7-CLK23, and 3G2NL-CLK23
- (2) The limit of 62,000 data link words applies to configurations of 62 nodes. Refer to the *Controller Link Unit Operation Manual (W309)* for other specifications.

**Ethernet Communications Specifications (Expansion Unit)**

Item	Specifications	
Type	100Base-TX (Can be used as 10Base-T)	
Media access method	CSMA/CD	
Modulation method	Baseband	
Transmission paths	Star form	
Baud rate	100 Mbit/s (100Base-TX)	10 Mbit/s (10Base-T)
Transmission media	Unshielded twisted-pair (UTP) cable Categories: 5, 5e Shielded twisted-pair (STP) cable Categories: 100 $\Omega$ at 5, 5e	Unshielded twisted-pair (UTP) cable Categories: 3, 4, 5, 5e Shielded twisted-pair (STP) cable Categories: 100 $\Omega$ at 3, 4, 5, 5e
Transmission distance	100 m (distance between hub and node)	
Number of cascade connections	2	4
Functions	<ul style="list-style-type: none"> <li>• FINS communications service</li> <li>• Socket service (UDP/TCP)</li> <li>• FTP server</li> <li>• Email send/receive</li> <li>• Automatic clock adjustment</li> </ul>	

Refer to the *Ethernet Units Construction of Networks Operation Manual* (W420) and the *Ethernet Units Construction of Applications Operation Manual* (W421) for other specifications.

## 3-2 System Configuration

### 3-2-1 Basic System Configuration

#### Systems without Expansion Unit

The basic system configuration when an Expansion Unit is not used is shown below.

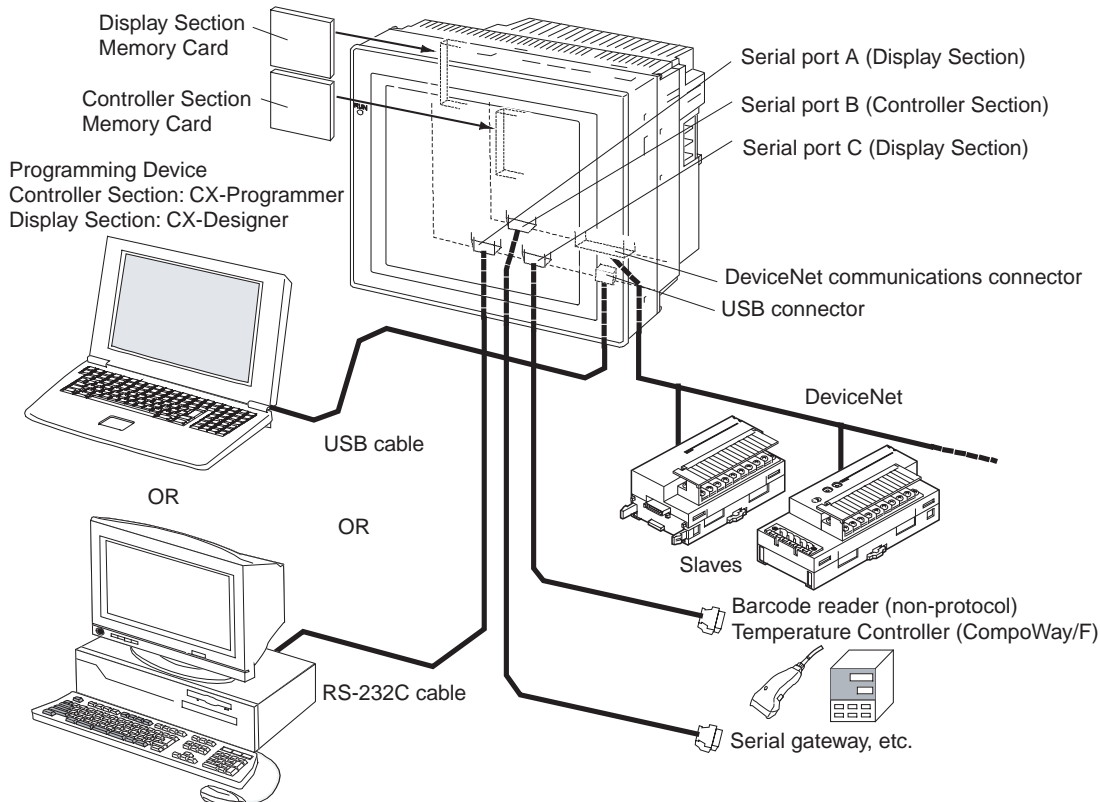

A Programming Device can be connected to the USB port, serial port A, or serial port B (Display Section). The functionality of serial ports A and B are the same as the ports on an NS-V2-series PT. If a Programming Device is not connected, a barcode reader, temperature controller, or other device can be connected.

Serial port C (Controller Section, RS-232C) has the same functionality as the RS-232C port on a CJ1-H CPU Unit with unit version 3.0. It can be used for a Host Link, NT Link, non-procedural, or serial gateway (CompoWay/F) connection.

The Controller Section provides DeviceNet master functionality as a standard feature. I/O can be controlled and message communications performed using DeviceNet within the limitations of the DeviceNet communications cycle.

Memory Cards are optional for both the Controller Section and Display Section.

The user must provide a 24-V DC power supply.

#### DeviceNet

DeviceNet is a multi-vendor network consisting of multi-bit control and information systems and conforms to the Open Field DeviceNet specification. Using the DeviceNet master functionality enables remote I/O communications between the NSJ Controller and the slaves on the network. Remote I/O communications enable large-capacity I/O and user-set allocations. Analog I/O Terminals and other devices are used for the slaves. Message communica-



tions are possible between NSJ Controllers and between the NSJ Controller and DeviceNet devices manufactured by other companies.

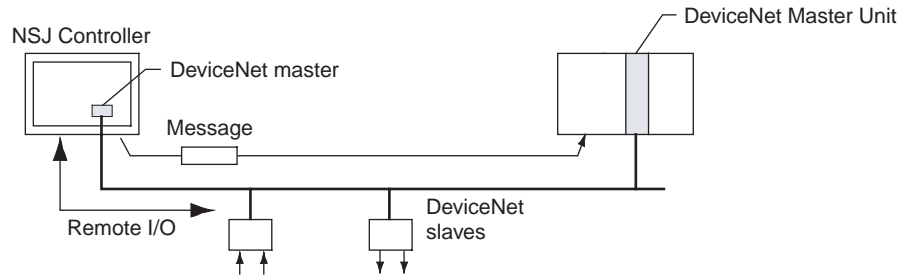

The DeviceNet functionality built into the NSJ Controller is equivalent to the functionality of the CJ-series DeviceNet Unit (CJ1W-DRM21). Refer to the following manuals for communications specifications, wiring methods, and functional details.

- DeviceNet Operation Manual (W267)
- CS/CJ Series DeviceNet Unit Operation Manual (W380)

**System Configurations with an Expansion Unit**

One of the NSJ Expansion Units can be mounted to enable connecting CJ-series Expansion Racks, to add a Controller Link port, or to add an Ethernet port. Refer to SECTION 5 Installation and Wiring for mounting methods.

**NSJ I/O Control Unit**

An NSJ I/O Control Unit (NSJW-IC101) can be mounted to enable connecting one CJ-series Expansion Rack to the NSJ□-□□□□-M3D or up to three CJ-series Expansion Racks to any other NSJ Controller. Up to 10 CJ-series I/O Units (Basic I/O Units, Special I/O Units, or CPU Bus Units) can be mounted to each Expansion Rack. The maximum number of I/O Units that can be connected in one NSJ Controller is thus 10 for the NSJ□-□□□□-M3D and 30 for any other NSJ Controller. Each Expansion Rack must have a Power Supply Unit and I/O Interface Unit (CJ1W-II101).

The maximum cable length for connecting all of the Expansion Racks is 12 m.

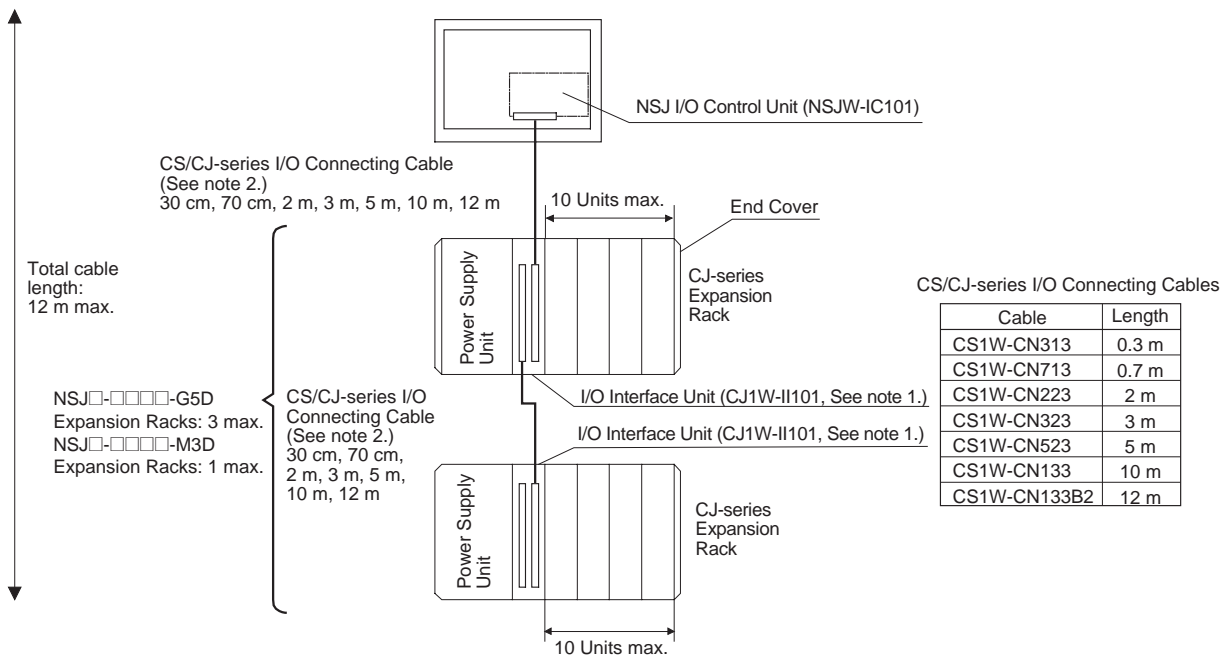

**Note** (1) Connect the I/O Interface Unit to the right of the Power Supply Unit.

- (2) The total length of I/O Connecting Cable between the NSJ Controller and first Expansion Rack and between Expansion Racks must be 12 m or less.
- (3) Connect the I/O Interface Unit directly to the right of the Power Supply Unit. Proper operation may not be possible if it is connected any other location.

**NSJ Controller Link Unit**

An NSJ Controller Link Unit (NSJW-CLK21-V1) can be mounted to enable using data links between NSJ Controllers and between NSJ Controllers and PLCs, so that data can be shared without programming, and FINS message communications between NSJ Controllers and between NSJ Controllers and PLCs, which enable separate control and data transfer when required. Data links and message communications are also possible between NSJ Controllers and personal computers. Data links enable large-capacity and user-set allocations. FINS message communications also allow large-capacity data transfer.

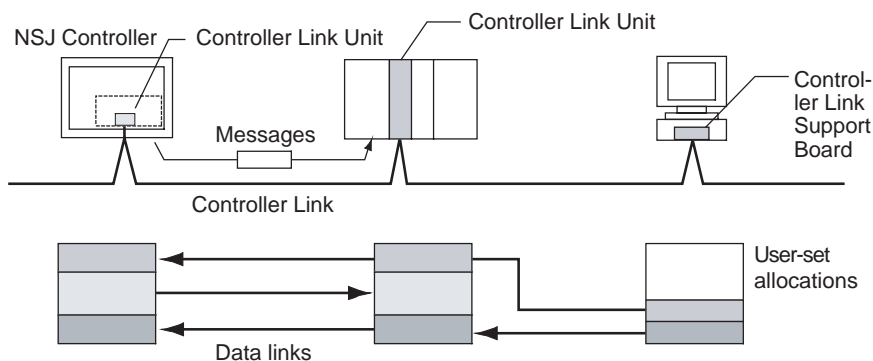

The functionality of the NSJ Controller Link Unit (NSJW-CLK21-V1) is equivalent to the functionality of the CJ-series Controller Link Unit (CJ1W-CLK21-V1, unit version 1.2).

**NSJ Ethernet Unit**

An NSJ Ethernet Unit (NSJW-ETN21) can be mounted to enable using FINS message communications between NSJ Controllers, between NSJ Controllers and PLCs, and between NSJ Controllers and host computers. By executing FTP commands for the NSJ Controller from a host computer connected to the Ethernet, the contents of the files on the Memory Card installed in the Controller Section can be read or written (transferred). Data can be sent and received using UDP and TCP protocols by sending/receiving data using SEND and RECV instructions or by using a socket service with CMND instructions. These functions enable a greater compatibility with information networks.

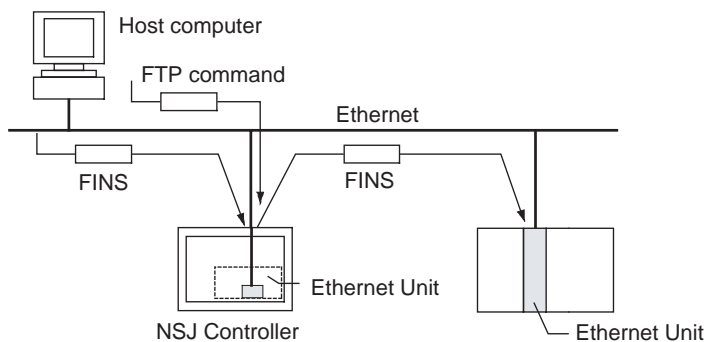

The functionality of the NSJ Ethernet Unit (NSJW-ETN21) is equivalent to the functionality of the CJ-series Ethernet Unit (CJ1W-ETN21, unit version 1.4).

### Products Used in the System Configuration

Name		Model	Specifications
NSJ-series NSJ Controller		NSJ□-□□□□- G5D	I/O capacity: 1,280 points, Program capacity: 60K steps, data memory capacity: 128 Kwords (DM Area: 32 Kwords, EM Area: 32 Kwords × 3 banks)
		NSJ□-□□□□- M3D	I/O capacity: 640 points, Program capacity: 20K steps, data memory capacity: 32 Kwords (DM Area: 32 Kwords, EM Area: None)
Memory Cards (for Controller Section or Display Section, optional)		HMC-EF372	Flash memory, 30 MB
		HMC-EF672	Flash memory, 64 MB
		HMC-AP001	Memory Card Adapter
Programming Device Connecting Cables	USB port	---	Use an off-the-shelf USB cable with a type B connector and a cable length of 5 m or less.
	RS-232C port	XW2Z-200S-CV	DOS D-sub 9-pin connector, cable length: 2.0 m. A connector with ESD countermeasures is used.
		XW2Z-500S-CV	DOS D-sub 9-pin connector, cable length: 5.0 m. A connector with ESD countermeasures is used.
	Ethernet port	---	Use an off-the-shelf 10Base-T or 100Base-T cable.
Battery Set		CJ1W-BAT01	---
Expansion Units	NSJ I/O Control Unit	NSJW-IC101	Enables connecting CJ-series Expansion Racks. Provides the same functionality as a CJ-series I/O Control Unit (CJ1W-IC101).
	NSJ Controller Link Unit	NSJW-CLK21-V1	Adds a Controller Link port. Provides the same functionality as a CJ-series Controller Link Unit (CJ1W-CLK21-V1).
	NSJ Ethernet Unit	NSJW-ETN21	Adds an Ethernet port. Provides the same functionality as a CJ-series Ethernet Unit (CJ1W-ETN21).

**Note** The following products are used when mounting an NSJ I/O Control Unit to the NSJ Controller and connecting CJ-series Expansion Racks.

Name	Model	Specifications	
NSJ I/O Control Unit	NSJW-IC101	Enables connecting CJ-series Expansion Racks to the NSJ Controller. (Connected to an I/O Interface Unit (CJ1W-II101) on a CJ-series Expansion Rack using a CS/CJ-series I/O Connecting Cables.)	
I/O Interface Unit	CJ1W-II101	One I/O Interface Unit is required on each CJ-series Expansion Rack. One End Cover is included. (Connected to the previous I/O Interface Unit or the NSJ I/O Control Unit using a CS/CJ-series I/O Connecting Cable.)	
CS/CJ-series I/O Connecting Cables	CS1W-CN313	Connect an I/O Control Unit (NSJW-IC101) to an I/O Interface Unit (CJ1W-II101) or connect two I/O Interface Units.	0.3 m
	CS1W-CN713		0.7 m
	CS1W-CN223		2 m
	CS1W-CN323		3 m
	CS1W-CN523		5 m
	CS1W-CN133		10 m
	CS1W-CN133B2		12 m
CJ-series Power Supply Units	CJ1W-PA205R	100 to 240 V AC (with RUN output), output capacity: 5 A at 5 V DC, 0.8 A at 24 V DC	
	CJ1W-PA205C	100 to 240 V AC (with replacement notification), output capacity: 4.6 A at 5 V DC, 0.8 A at 24 V DC	
	CJ1W-PA202	100 to 240 V AC, output capacity: 2.8 A at 5 V DC, 0.4 A at 24 V DC	
	CJ1W-PD025	24 V DC, output capacity: 5 A at 5 V DC, 0.8 A at 24 V DC	
	CJ1W-PD022	24 V DC (not insulated), output capacity: 2.0 A at 5 V DC, 0.4 A at 24 V DC	

Name	Model	Specifications
End Cover	CJ1W-TER01	An End Cover must be attached to the right end of a CJ-series Expansion Rack. A fatal error will occur if an End Cover is not attached. <b>Note</b> One End Cover is provided with each I/O Interface Unit.
DIN Tracks	PFP-50N	Length: 50 cm, height: 7.3 mm
	PFP-100N	Length: 1 m, height: 7.3 mm
	PFP-100N2	Length: 1 m, height: 16 mm
	PFP-M	Stopper. Stoppers must be connected to the left and right ends of the Rack to prevent it from moving. Two Stoppers are included with the I/O Interface Unit.

**Optional Products for the Display Section**

Model	Description
NS12-KBA04	Anti-reflection Sheets for NS12/NS10
NS7-KBA04	Anti-reflection Sheets for NS8
NT30-KBA04	Anti-reflection Sheets for NS5
NS12-KBA05	Opaque White Protective Cover for NS12 and NS10 (anti-reflection coating)
NS7-KBA05	Opaque White Protective Cover for NS8 (anti-reflection coating)
NT31C-KBA05	Opaque White Protective Cover for NS5 (anti-reflection coating)
NS12-KBA05N	Transparent Protective Cover for NS12 and NS10
NS7-KBA05N	Transparent Protective Cover for NS8
NT31C-KBA05N	Transparent Protective Cover for NS5
NT30-KBA01	Chemical-resistant Cover

Use the suitable NS5, NS8, NS10, and NS12 options for the size of the Display Section on the NSJ Controller.

**Connecting Programming Devices**

**USB Port**

Use an off-the-shelf USB cable to connect to the USB slave connector on the Display Section. The Display Section has a type B USB connector.

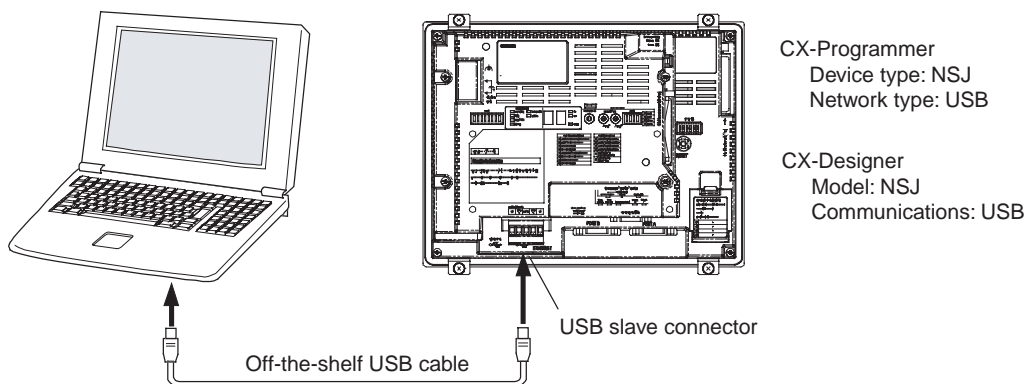

**Note** The USB driver must be installed in the computer. Refer to 2-2 *Installing the USB Driver* for details.

**Serial Port A or B on Display Section (RS-232C)**

Use one of the following Connecting Cables.

- XW2Z-200S-CV
- XW2Z-500S-CV

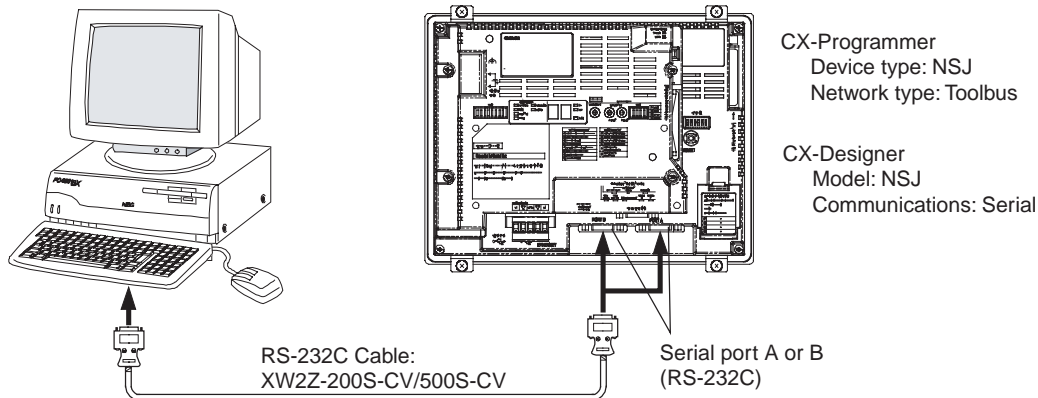

**Ethernet Port**

The Programming Device can be connected to the Ethernet Port on any NSJ Controller model with a built-in Ethernet port.

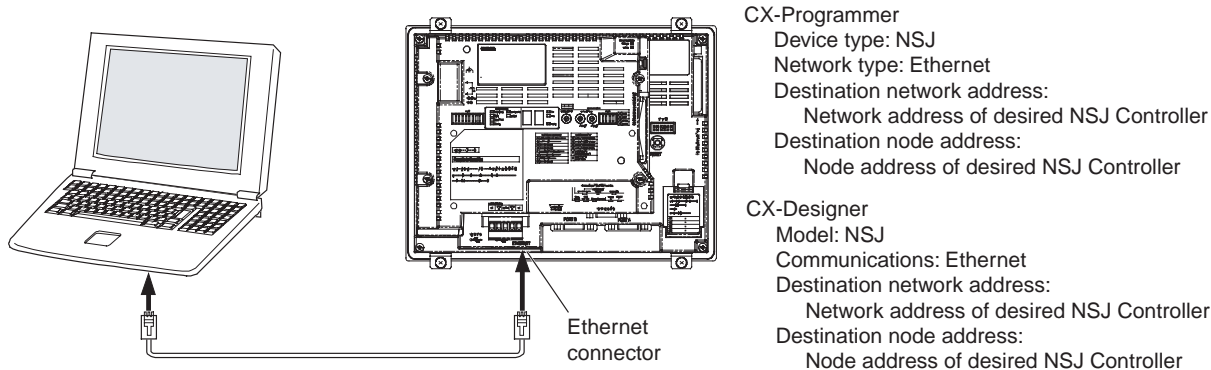

**Accessing Ethernet Nodes with a USB Connections**

A Programming Device connected to the USB port on an NSJ Controller can be used to access and control other NSJ Controllers on the Ethernet network by setting the Ethernet node address of the desired NSJ Controller.

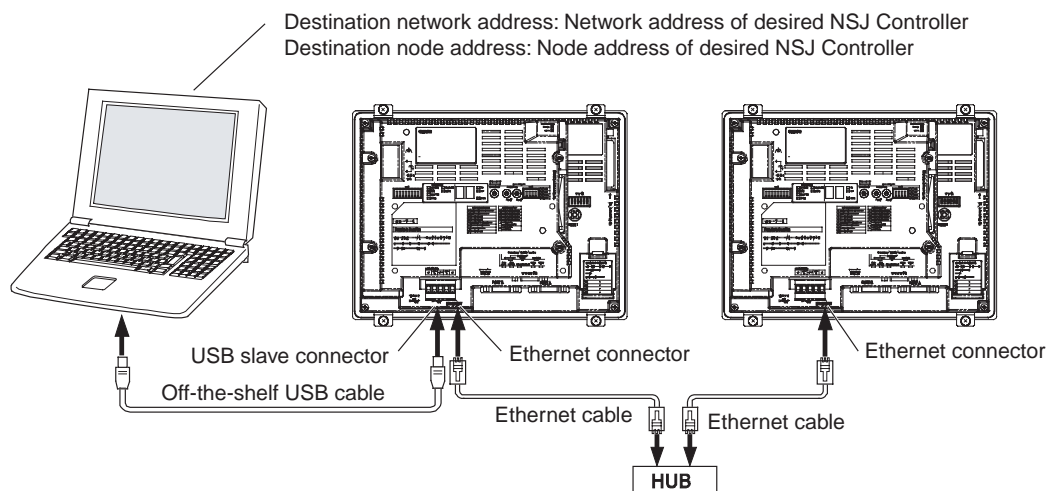

Support Software

NSJ Controller	OS	Name	Model	Remarks
NSJ□-□□□□-G5D	Windows	CX-One Ver. 1.1 or higher	CXONE-AL□□C-E	Provided on CD-ROM.
NSJ□-□□□□-M3D	Windows	CX-One Ver. 2.0 or higher	CXONE-AL□□C-E	Provided on CD-ROM.

### 3-2-2 Expanded System Configurations

#### Serial Communications

Serial ports A and B on the Display Section and serial port C on the Controller Section can be used in various ways, as described in this section.

#### Barcode Readers

Information from a barcode reader can be input to the Display Section without going through the Controller Section by connecting the barcode reader to serial port A or B on the Display Section.

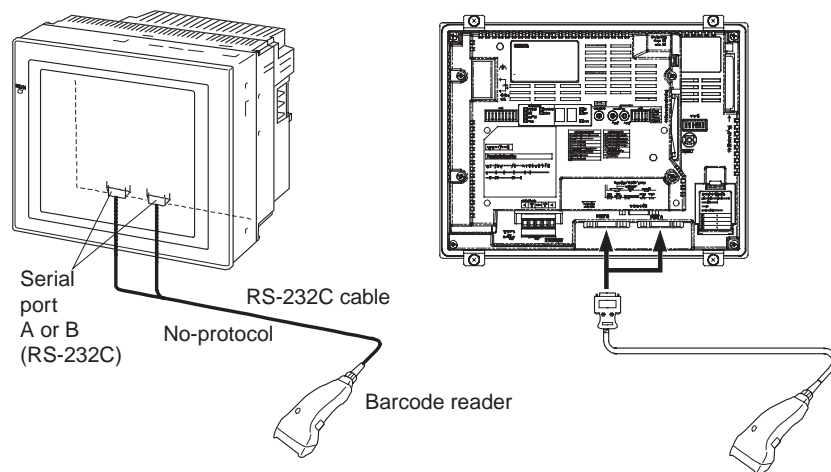

If data input via no-protocol communications must be processed using the ladder program in the Controller Section, serial port C on the Controller Section is used.

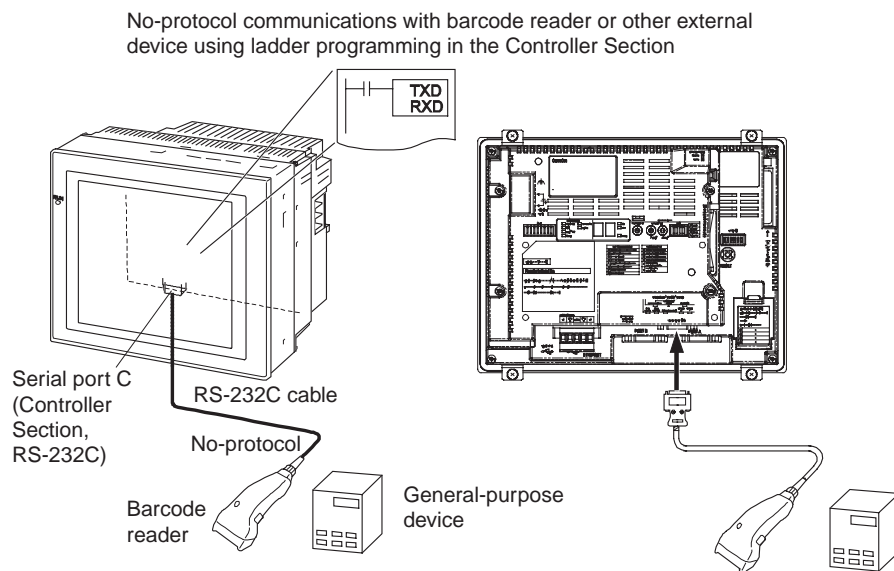

Temperature Controllers

If Smart Active Parts (SAP) are to be used with direct connections to OMRON Temperature Controllers, serial port A or B on the Display Section is used. The Display Section internally sends FINS messages to the Temperature Controllers.

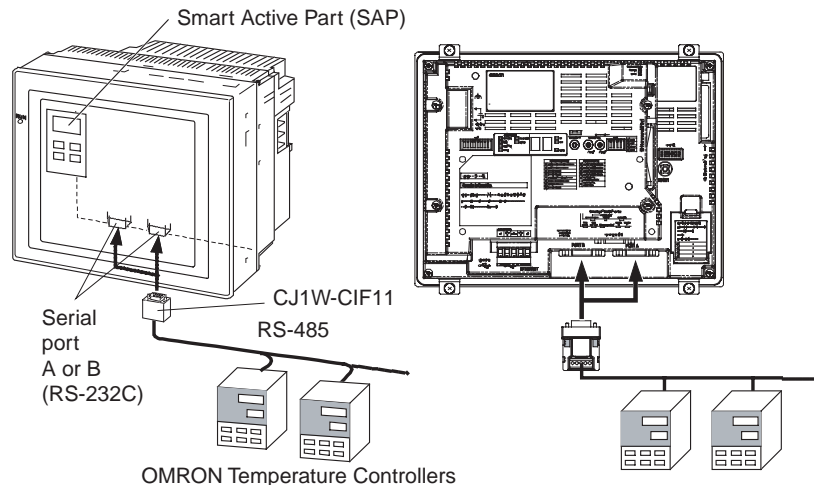

If objects from the Smart FB Library are used to read or write data to OMRON Temperature Controllers using the ladder program in the Controller Section, serial port C on the Controller Section is used. The Controller Section send FINS message through the serial port on the Controller Section. If the serial gateway is used for the serial port on the Controller section, CompoWay/F can be used to access any of the OMRON Temperature Controllers connected serially.

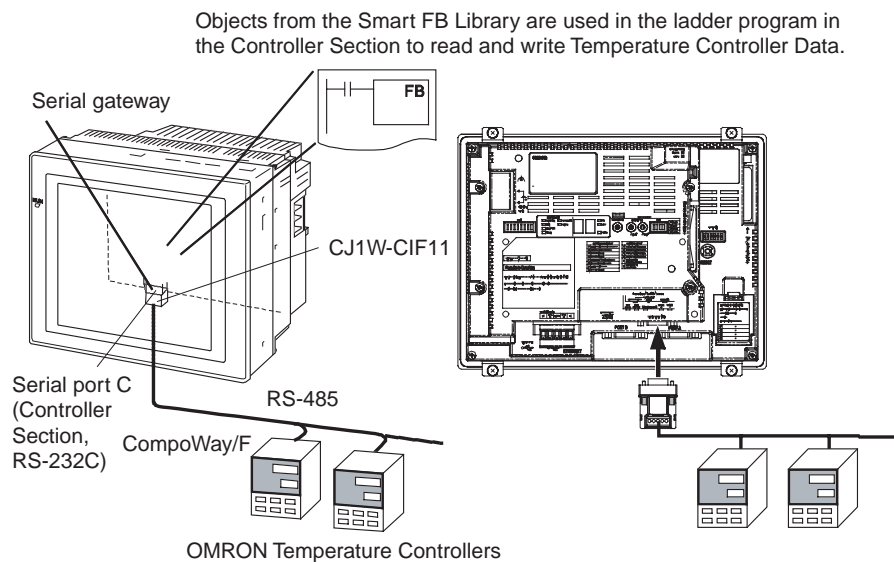





# SECTION 4

## Nomenclature, Functions, and Dimensions

The section give the names of the parts of the NSJ Controller, describes the function of each part, and provides NSJ Controller Dimensions.

4-1	Nomenclature and Functions .....	74
4-1-1	Nomenclature .....	74
4-1-2	Functions of Parts .....	75
4-1-3	Expansion Unit Nomenclature and Functions .....	84
4-2	Dimensions .....	87
4-2-1	Dimensions .....	87

# 4-1 Nomenclature and Functions

## 4-1-1 Nomenclature

### Front

NSJ12-TS0□(B)-G5D, NSJ10-TV0□(B)-G5D, NSJ8-TV0□(B)-□□□, NSJ5-TQ□□(B)-□□□, and NSJ5-SQ□□(B)-□□□

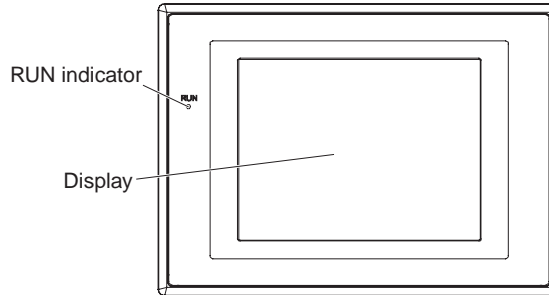

### Back

NSJ12-TS0□(B)-G5D, NSJ10-TV0□(B)-G5D, and NSJ8-TV0□(B)-□□□

The NSJ8-TV0□(B)-□□□ is shown below. The sizes of the NSJ12-TS0□(B)-G5D, and NSJ10-TV0□(B)-G5D differ, but the basic structure is the same.

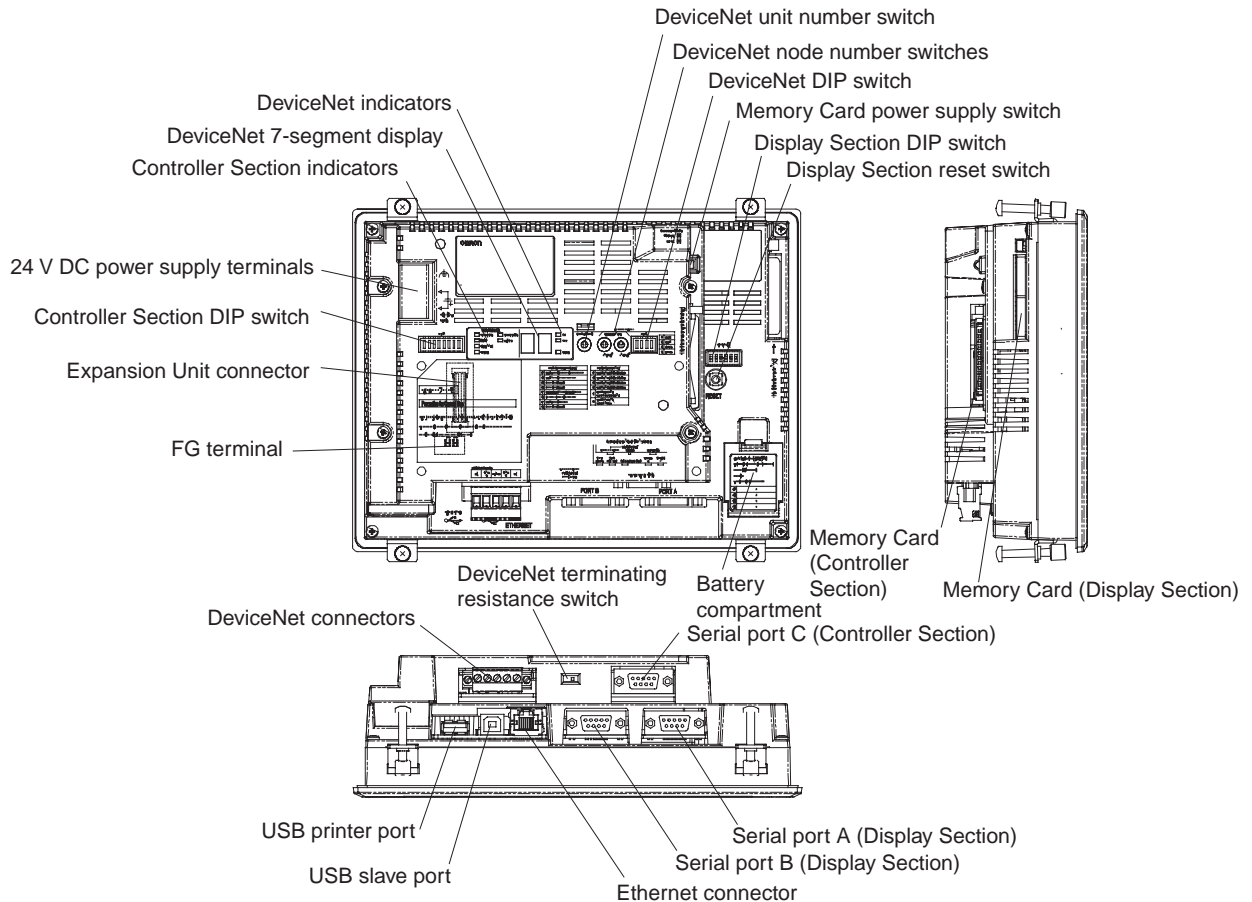

**Note** The following NSJ Controllers do not have an Ethernet connector: NSJ12-TS00(B)-G5D, NSJ10-TV00(B)-G5D, and NSJ8-TV00(B)-□□□.

NSJ5-TQ□□(B)-□□□ and NSJ5-SQ□□(B)-□□□

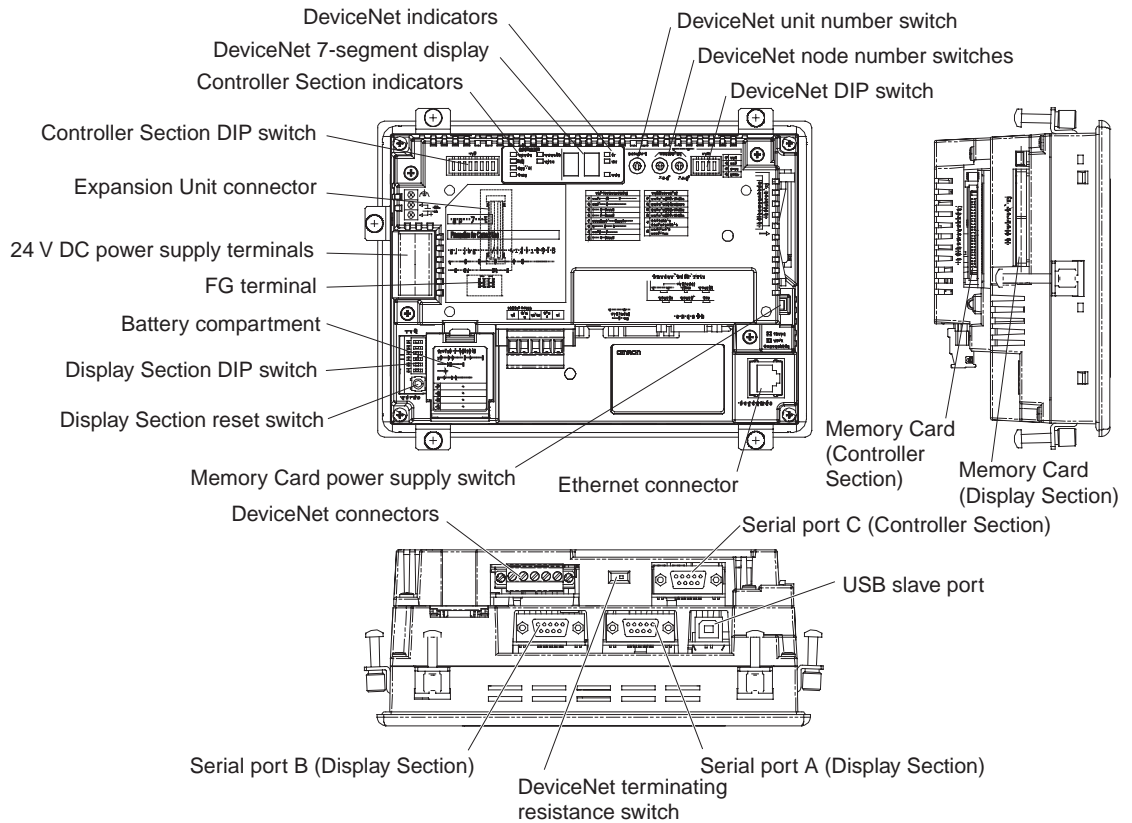

**Note** The following NSJ Controllers do not have an Ethernet connector: NSJ5-TQ□□(B)-□□□ and NSJ5-SQ□□(B)-□□□.

4-1-2 Functions of Parts

RUN Indicator

The RUN indicator shows the operating status of the NSJ Controller (including the Controller Section and Expansion Unit).

Indicator	Green	Orange	Red
Lit	NSJ Controller is operating normally.	The file system check that is performed immediately after the power is turned ON is in progress.	A fatal error has occurred in the Controller Section. A WDT error has occurred in the Controller Section.
Flashing	Memory Card transfer ended normally, but a backlight error occurred immediately after the power supply was turned ON.	Memory Card transfer in progress.	Memory Card transfer ended in an error. A non-fatal error has occurred in the Controller Section. An initialization error has occurred in the Controller Section.
Not lit	<ul style="list-style-type: none"> <li>Power is not being supplied to the NSJ Controller.</li> <li>The fuse is broken.</li> <li>The system program is corrupted and the system cannot be booted.</li> </ul>		

For lot number 15Z0 or later, the brightness of the indicator will change according to the backlight brightness setting. (NSJ5-SQ1/-TQ1 only)

**Controller Section**

**Controller Section Indicators**

The Controller Section indicators show the status of the Controller Section.

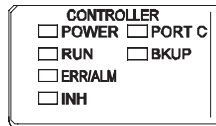

Indicator	Color	Status	Meaning
POWER	Green	ON	Power is being supplied.
		OFF	Power is not being supplied.
RUN	Green	ON	The Controller Section is operating normally in MONITOR or RUN mode.
		Flashing	DIP switch settings error.
		OFF	The Controller Section has stopped operating while in PROGRAM mode or has stopped operating due to a fatal error.
ERR/ALM	Red	ON	A fatal error has occurred (including FALS instruction execution) or a hardware error (watchdog timer error) has occurred. The Controller Section will stop operating, and all outputs will turn OFF.
		Flashing	A non-fatal error has occurred (including FAL instruction execution). The Controller Section will continue operating.
		OFF	The Controller Section is operating normally.
INH	Orange	ON	The Output OFF Bit (A50015) is ON. Outputs from all Output Units will turn OFF.
		OFF	The Output OFF Bit (A50015) is OFF.
PORTC	Orange	Flashing	The Controller Section is communicating (sending or receiving) via the Controller Section's RS-232C port.
		OFF	The Controller Section is not communicating via the Controller Section's RS-232C port.
BKUP	Orange	ON	Data is being written to flash memory (backup memory). This indicator will also light when the user program is being restored after the power supply to the NSJ Controller is turned ON. <b>Note</b> Do not turn OFF the power supply to the NSJ Controller while this indicator is lit.
		OFF	Data is not being written to flash memory.

**Controller Section DIP Switch**



Pin no.	Setting	Function	Usage	Default
1	ON	Writing disabled for user program memory. (See note.)	Used to prevent programs from being accidentally overwritten from Programming Devices (the CX-Programmer).	OFF
	OFF	Writing enabled for user program memory.		
2	ON	The user program is automatically transferred from the Memory Card when power is turned ON.	Used to store the programs in the Memory Card to switch operations, or to automatically transfer programs at startup (Memory Card ROM operation). <b>Note</b> When pin 7 is ON and pin 8 is OFF, easy backup reading from the Memory Card is given priority, so even if pin 2 is ON, the user program will not be automatically transferred from the Memory Card when power is turned ON.	OFF
	OFF	The user program is not automatically transferred from the Memory Card when power is turned ON.		
3	Keep turned OFF.	---	---	OFF
4	Keep turned OFF.	---	---	OFF

Pin no.	Setting	Function	Usage	Default
5	ON	RS-232C port communications parameters set using the CX-Programmer (Toolbus only) are used.	Turn ON to use the RS-232C port for the CX-Programmer in Toolbus mode.	OFF
	OFF	RS-232C port communications parameters set in the PLC Setup are used.		
6	ON	User-defined pin. Turns ON the User DIP Switch Pin Flag (A39512).	Set pin 6 to ON or OFF and use A39512 in the program to create a user-defined condition without using an Input Unit.	OFF
	OFF	User-defined pin. Turns OFF the User DIP Switch Pin Flag (A39512).		
7		Easy backup type	Determines the type of easy backup to be performed. See <i>Table 1</i> , below.	OFF
8	Keep turned OFF.	---		OFF

**Table 1**

DIP switch pin	Easy backup type	Required operations
Pin No. 7		
ON	Writing from Controller Section to Memory Card.	Press the Memory Card Power Supply Switch for 3 s while power is ON.
	Writing from Memory Card to Controller Section.	Turn ON the power supply to the NSJ Controller. <b>Note</b> This operation is given priority over automatic transfer (pin 2 is ON) at startup.
OFF	Verifying contents of Memory Card against the contents of the Controller Section.	Press the Memory Card Power Supply Switch for 3 s while power is ON.

- Note**
- The following data cannot be overwritten when pin 1 is ON:
    - All parts of the user program (programs in all tasks)
    - All data in the parameter area (such as the PLC Setup and I/O tables)
 When pin 1 is ON, the user program and parameter area will not be cleared when the memory clear operation is performed from the CX-Programmer.
  - The Controller Section will not enter any mode except PROGRAM mode after backing up data to a Memory Card using the easy backup operation. To enter RUN or MONITOR mode, turn OFF the power supply, turn OFF pin 7, and then restart the NSJ Controller. This will enable changing the operating mode as normal.

**Controller Section Memory Card**

A Memory Card can be used to back up all Controller Section data, including the user program, parameters, I/O memory, and comment memory files. Automatically transferring data from the Memory Card at startup can also be used to enable batteryless operation.

**Memory Card Power Supply Switch**

Press the power supply switch to disconnect power before removing the Memory Card. Also, press the Memory Card Power Supply Switch to perform an easy backup operation.

**Serial Port C**

Serial port C has the same functionality as the RS-232C port on a CJ1-H CPU Unit with unit version 3.0. The following serial communications modes are supported: Toolbus, Host Link, NT Link, No-protocol, and Serial Gateway.

**Expansion Unit Connector**

An Expansion Unit can be mounted here.

**DeviceNet Section (in Controller Section)**

**DeviceNet Indicators**

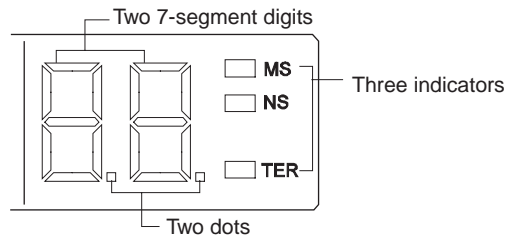

■ **MS, NS, and TER Indicators**

The MS (Module Status) indicator indicates the status of the node and the NS (Network Status) indicator indicates the status of the network.

The TER indicator indicates whether terminating resistance is connected.

The MS and NS indicators can be green or red and they can be OFF, ON, or flashing, and the TER indicator can be ON or OFF. The following table shows the meaning of these indicator conditions.

Indicator	Color	Status	Meaning (likely errors)
MS	Green	ON	Normal operating status. Communications are being performed normally.
		ON	A non-recoverable, fatal error has occurred (watchdog timer error, memory error, or system error). If the error persists even when the power supply is cycled, replace the NSJ Controller.
		Flashing	A recoverable, non-fatal error has occurred (configuration error, switch setting error, Controller Section initialization error, Controller Section interface error, or routing table error). Correct the error and reset the Unit.
	---	OFF	Power isn't being supplied or the Unit is being reset.
NS	Green	ON	The NSJ Controller is online with the network and remote I/O communications have been established with a slave registered in the scan list or message communications have been established.
		Flashing	The NSJ Controller is online with the network, but neither remote I/O communications nor message communications have been established. Either the scan list is being read, or both remote I/O communications and message communications are disabled.
	Red	ON	A fatal communications error has occurred. Network communications are not possible (node address duplicated or Bus Off error).
		Flashing	A non-fatal communications error has occurred (communications error, configuration error, or verification error).
	---	OFF	The NSJ Controller is not online with the network. (There is no network power supply, the Controller Section is being reset, a minor failure, or a sending error has occurred.)
TER	Orange	ON	Terminating resistance connected.
		---	OFF

**Note** Flashing indicators are ON for 0.5 s and OFF for 0.5 s.

■ **Seven-Segment Display**

The 7-segment display normally indicates the master node address in decimal between 00 and 63. When an error occurs, the display will alternate between the error code and the node address of the faulty slave.

There are dot indicators at the lower-right corner of each digit. The left dot indicator shows whether the scan list is enabled or disabled. The right dot indicator shows whether the slave is operating.

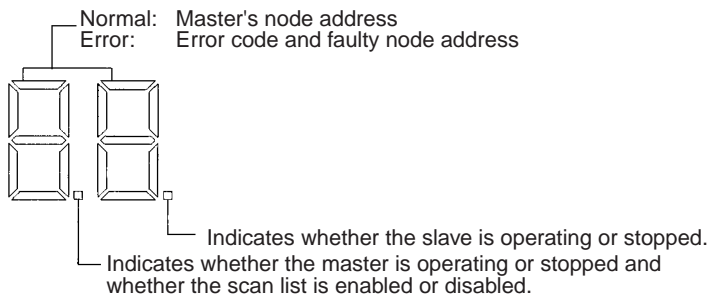

**Seven-segment Display**

The following table shows the functions of the 7-segment display.

Status		Display	
Remote I/O communications active and normal	Displays the master's node address (00 to 63)	Lit	
From power ON to completion of node address check (master function disabled, slave function disabled, or both disabled)		Flashing	
Remote I/O communications started		Flashing (until communications actually start)	
From completion of the node address check until the start of remote I/O communications		Flashing	
Error	Watchdog timer	Not lit	
	Memory error or system error	Error code only	Lit
	Other errors	Alternately displays the error code and error node address (see diagram below).	
Scan list	Reading	“- .”	Flashing
	Registered		

The following diagram shows the alternating error code/ node address display.

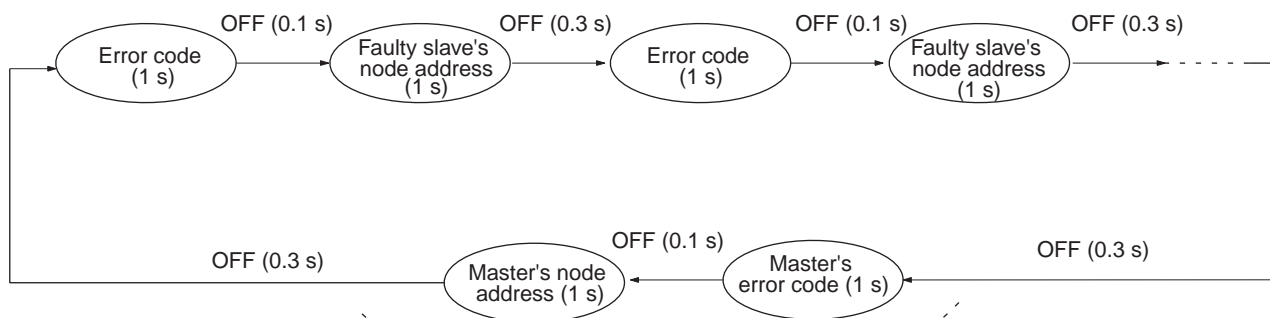

If there is an error in the master function.

The master's error code and master's node address will be displayed if an error has occurred in the master.

There is no priority in the error codes; all errors that have occurred will be displayed in order.

**Dot Indicators**

The following table shows the functions of the dot indicators.

Indicator	Content	Display
Left dot	Scan list enabled/ disabled, master function disabled	ON: Master function disabled Flashing: Scan list disabled mode OFF: Scan list enabled mode
Right dot	Slave function dis- abled	ON: Slave function disabled OFF: Slave operating

**DeviceNet Unit Number Switch**

Use this switch to set the unit number of the DeviceNet Section as a CPU Bus Unit. The unit number setting determines the CIO and DM area words allocated to the DeviceNet Section as software switches and the status area.

	Setting method	One-digit hexadecimal
	Setting range	0 to F

- Note**
1. The unit number is set to 0 at the factory.
  2. Any unit number from 0 to F can be set as long as it hasn't been set on another CPU Bus Unit connected to the same NSJ Controller.
  3. Use a small flat-blade screwdriver to turn the rotary switch; be careful not to damage the switch.
  4. If the unit number is the same as one set on another CPU Bus Unit connected to the same NSJ Controller, a duplicate number error will occur in the NSJ Controller and it won't be possible to start the DeviceNet network.
  5. Always turn OFF the NSJ Controller before changing the unit number setting.

**DeviceNet Node Address Switches**

Use these switches to set the node address of the Unit.

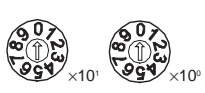
	Setting method	Two-digit decimal
	Setting range	0 to 63

- Note**
1. The node address is set to 63 at the factory.
  2. Any node address from 0 through 63 can be set as long as it hasn't been set on another slave node.
  3. If the node address is the same as one set on another node, a node address duplication error will occur and it won't be possible to start up network communications.
  4. Node address 0 cannot be used for FINS message communication. Use a node address other than 0 for FINS message communication.



**DeviceNet DIP Switch**

The DeviceNet DIP switch is used to set the baud rate, whether remote I/O communications will be continued or stopped when a communications error occurs, and whether to hold or clear the remote outputs when a communications error occurs in the slave function.

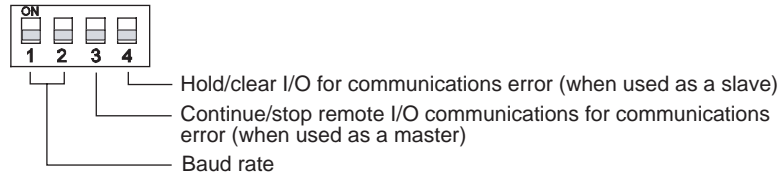

The settings of the DIP switch pins are shown in the following table. All pins are set to OFF at the factory.

Pin	Function	Setting
1	Baud rate	See the next table.
2		
3	Continue/stop remote I/O communications for communication errors (when used as a master)	OFF: Continue communications ON: Stop communications
4	Hold/clear remote outputs for communications error (when used as a slave)	OFF: Clear remote outputs ON: Hold remote outputs

**Baud Rate**

Pins 1 and 2 are used to set the baud rate as shown in the following table.

Pin 1	Pin 2	Baud rate
OFF	OFF	125 kbps
ON	OFF	250 kbps
OFF	ON	500 kbps
ON	ON	Not allowed.

- Note**
1. Always turn OFF the NSJ Controller before changing the DIP switch settings.
  2. Set the same baud rate on all of the nodes (master and slaves) in the Network. Any slaves with baud rates different from the master's rate won't be able to participate in communications and may cause a communications error between nodes that have been set properly.

**Continue/Stop Remote I/O Communications**

When the DeviceNet Section is used as a master, pin 3 is used to set whether or not communications will stop after a communications error.

If pin 3 is ON, remote I/O communications will be stopped if one of the following errors occurs.

- Remote I/O Communications Error Flag (n+12, bit 02 is ON, See note.)
- Send Timeout Flag (n+10, bit 08 is ON)
- Network Power Error Flag (n+10, bit 07 is ON)

Remote I/O communications will remain stopped even if the error is cleared. (Message communications and slave functions will continue.) To resume communications, turn ON the Remote I/O Communications Start Bit (word n, bit 02) of Software Switches 1. Refer to 3-2 *Allocated CIO Area Words* in the *CS/CJ-series DeviceNet Unit Operation Manual* for details.

**Note** The 7-segment display will show "A0" when remote I/O communications stop.

If pin 3 is OFF, remote I/O communications will stop if a send timeout or network power error occurs, but will restart automatically when the cause of the error is cleared.

**Hold/Clear Remote Outputs**

When the DeviceNet Section is used as a slave, pin 4 is used to set whether to hold or clear remote outputs when a communications error occurs.

**Note** If the DeviceNet Section is used as a slave, the 7-segment display will show "L9" when remote I/O communications stop.

**DeviceNet Terminating Resistance Switch**

Turn ON this switch to connect terminating resistance at each of the nodes on the end of the DeviceNet network's trunk line. The status of this switch is shown by the TER indicator.

**Note** This switch is set to OFF (terminating resistance not connected) at the factory.

**DeviceNet Connectors**

Color stickers that match communications cable colors are attached to the communications connectors. Match the colors when connecting communications cables to the connectors. These colors are given in the following table

Color	Signal
Black	Power line, negative voltage (V-)
Blue	Communications line, low (CAN L)
---	Shield
White	Communications line, high (CAN H)
Red	Power line, positive voltage (V+)

For details on communications specifications and wiring, refer to the *DeviceNet Operation Manual (W267)*.

**Note** Before connecting communications cables, turn OFF the NSJ Controller power supply, all slave power supplies, and the communications power supply.

**Display Section**

**Touch Panel**

The touch panel is a color TFT LCD screen or a color STN LCD (NSJ5-SQ0□(B)-□□□ only). The touch switches on the front panel of the Display Section are used to perform input operations.

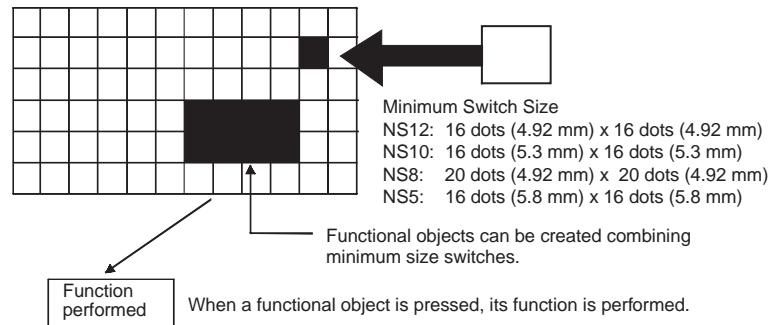

To ensure correct input operations, create touch switches so that they consist of at least two switches horizontally and vertically.

- Note**
- (1) Press the touch switches with a pressure of 30 N max.
  - (2) Do not press the touch switches when the backlight is not lit or when there is no display.
  - (3) Check system safety before pressing the touch switches.
  - (4) Inputs may not be recognized if the touch switches are pressed in rapid succession. Check that one input operation has finished before performing the next one.

(5) Pressing Three Switches Simultaneously

If the positions of multiple touch switches are set as shown in the example and three switches are pressed simultaneously, the touch switches will malfunction due to structural characteristics.

Position the touch switches carefully. In the example shown below, switches have been created in positions A and B, and at points C and D, where the vertical and horizontal lines through A and B intersect.

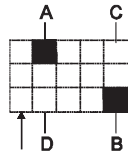

Minimum touch switch frame

- If touch switches A, B, and C are turned ON simultaneously, switch D may also turn ON due to structural characteristics of the touch panel.
- In the same way, if touch switches A, B, and D are turned ON simultaneously, switch C may also turn ON.

**Display Section Memory Card**

The Memory Card in the Display Section is used to back up screen data and log files.

**Display Section DIP Switch**

The DIP switch on the Display Section is used to specify banks and transfer methods for the Memory Card.

**NSJ8/NSJ10/NSJ12**



**NSJ5**



Pin No.	Function
1	Specifies bank 1 when transferring. (ON: Specifies bank 1.)
2	Specifies bank 2 when transferring. (ON: Specifies bank 2.)
3	Specifies bank 3 when transferring. (ON: Specifies bank 3.)
4	Specifies bank 4 when transferring. (ON: Specifies bank 4.)
5	Specifies upload or download. (ON: Upload, OFF: Download)
6	Specifies manual or automatic transfer. (ON: Manual, OFF: Automatic)

**Reset Switch**

The reset switch initializes Display Section status. It will not affect the Controller Section.

**24 V DC Power Supply Terminals**

Connect a 24 V DC power supply to these terminals.

Item	Value
Power supply voltage	24 V DC
Allowable power supply voltage range	20.4 to 27.6 V DC (24 V DC $\pm$ 15%)
Power supply capacity	25 W min. (NSJ5: 15 W min.)

**USB Slave Connector**

Connect a Programming Device to this connector. This is a type B USB connector.

**USB Printer Connector**

Connect a printer to this connector. This is a type A USB connector. There is no USB printer connector on the NSJ5-TQ□□-□□□□ or NSJ5-SQ□□-□□□□.

**Serial Ports A and B**

These ports have the same functionality as the RS-232C port on an NS-series PT. A Programming Device can also be connected.

**Ethernet Connector**

Connect an Ethernet cable with a 10Base-T or 100Base-T, 8-pin modular plug. A Programming Device can also be connected. The following models do not have an Ethernet connector: NSJ12-TS00-G5D, NSJ10-TV00-G5D, NSJ8-TV00-□□□, NSJ5-TQ□0-□□□, and NSJ5-SQ□0-□□□.

**Battery Compartment**

The CJ1W-BAT01 Battery for the NSJ Controller is mounted inside this compartment.

**4-1-3 Expansion Unit Nomenclature and Functions**

**NSJ I/O Control Unit (NSJW-IC101)**

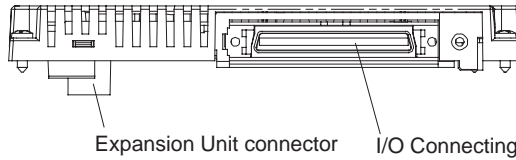
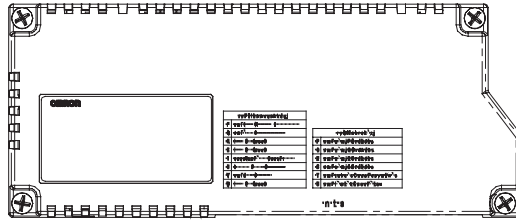

The I/O Connecting Cables listed in the following table can be used. Refer to 5-3-2 *Wiring an NSJ I/O Control Unit* for connecting methods.

Model	Cable length
CS1W-CN313	0.3 m
CS1W-CN713	0.7 m
CS1W-CN223	2 m
CS1W-CN323	3 m
CS1W-CN523	5 m
CS1W-CN133	10 m
CS1W-CN133B2	12 m

**NSJ Controller Link Unit (NSJW-CLK21-V1)**

The functionality of the NSJ Controller Link Unit is equivalent to the functionality of the CJ-series Controller Link Unit (CJ1W-CLK21-V1, unit version 1.2). Refer to the *Controller Link Units Operation Manual (W309)* for details.

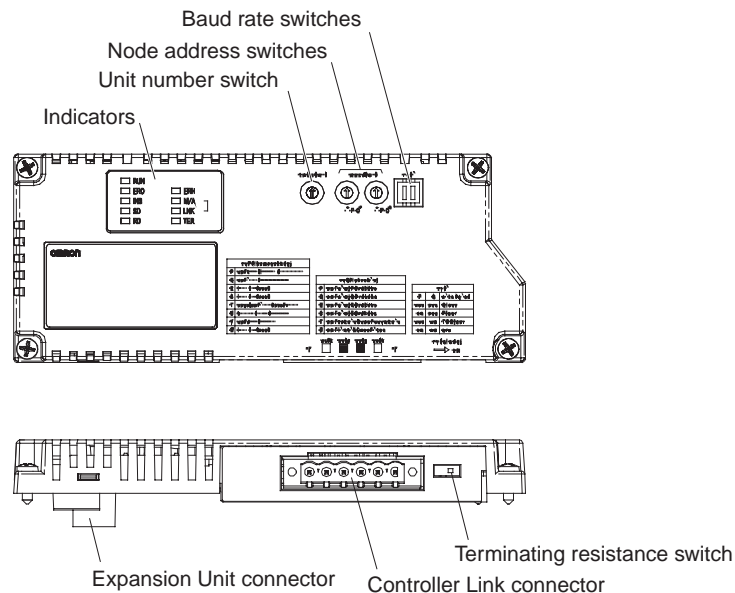

**Indicators**

The indicators show the status of the Unit and the network.

**Unit Number Switch**

Set the unit number of the NSJ Controller Link Unit as a CPU Bus Unit as a 1-digit hexadecimal value.

**Node Address Switches**

Set the node address of the NSJ Controller Link Unit on the Controller Link network as a 2-digit decimal value.

**Baud Rate Switch**

Set the 2-pin DIP switch to the baud rate of the Controller Link network.

**Terminating Resistance Switch**

Turn ON the terminating resistance switch to connect terminating resistance at both end of the Controller Link network.

**Controller Link Connector**

Connect the Controller Link network communications cable (twisted-pair cable). Refer to 5-3-3 *Wiring the NSJ Controller Link Unit* for connection methods.

**NSJ Ethernet Unit  
(NSJW-ETN21)**

The functionality of the NSJ Ethernet Unit is equivalent to the functionality of the CJ-series Ethernet Unit (CJ1W-ETN21, unit version 1.4). Refer to the *CS/CJ-series Ethernet Units Construction of Networks Operation Manual (W420)* for details.

The NSJ Ethernet Unit also comes with labels that can be attached to the Unit to show the IP address and subnet mask set by the user. Using this label will enable easy confirmation of the IP address and subnet mask.

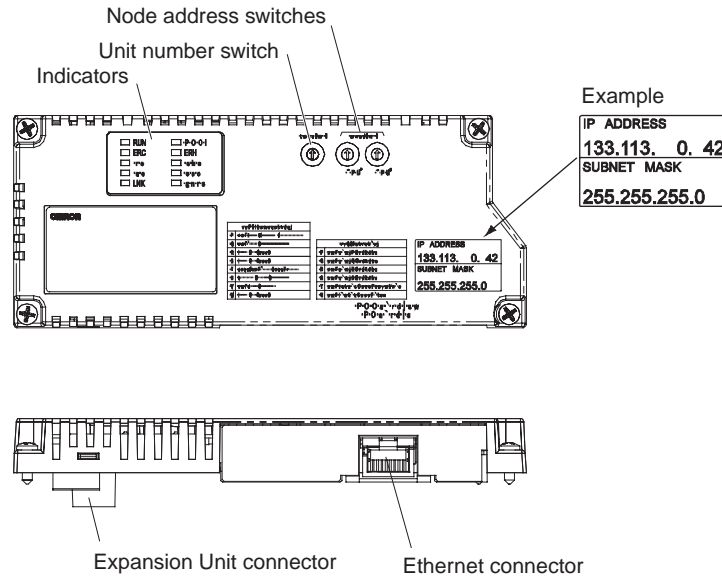

**Indicators**

The indicators show the status of the Unit.

**Unit Number Switch**

Set the unit number of the NSJ Ethernet Unit as a CPU Bus Unit as a 1-digit hexadecimal value.

**Node Address Switches**

Set the FINS node address of the NSJ Ethernet Unit as a 2-digit hexadecimal value.

**Ethernet Connector**

Connect the Ethernet twisted-pair cable. Refer to *5-3-4 Wiring the NSJ Ethernet Unit* for connection methods.

# 4-2 Dimensions

## 4-2-1 Dimensions

### NSJ12-TS0□(B)-G5D and NSJ10-TV0□(B)-G5D

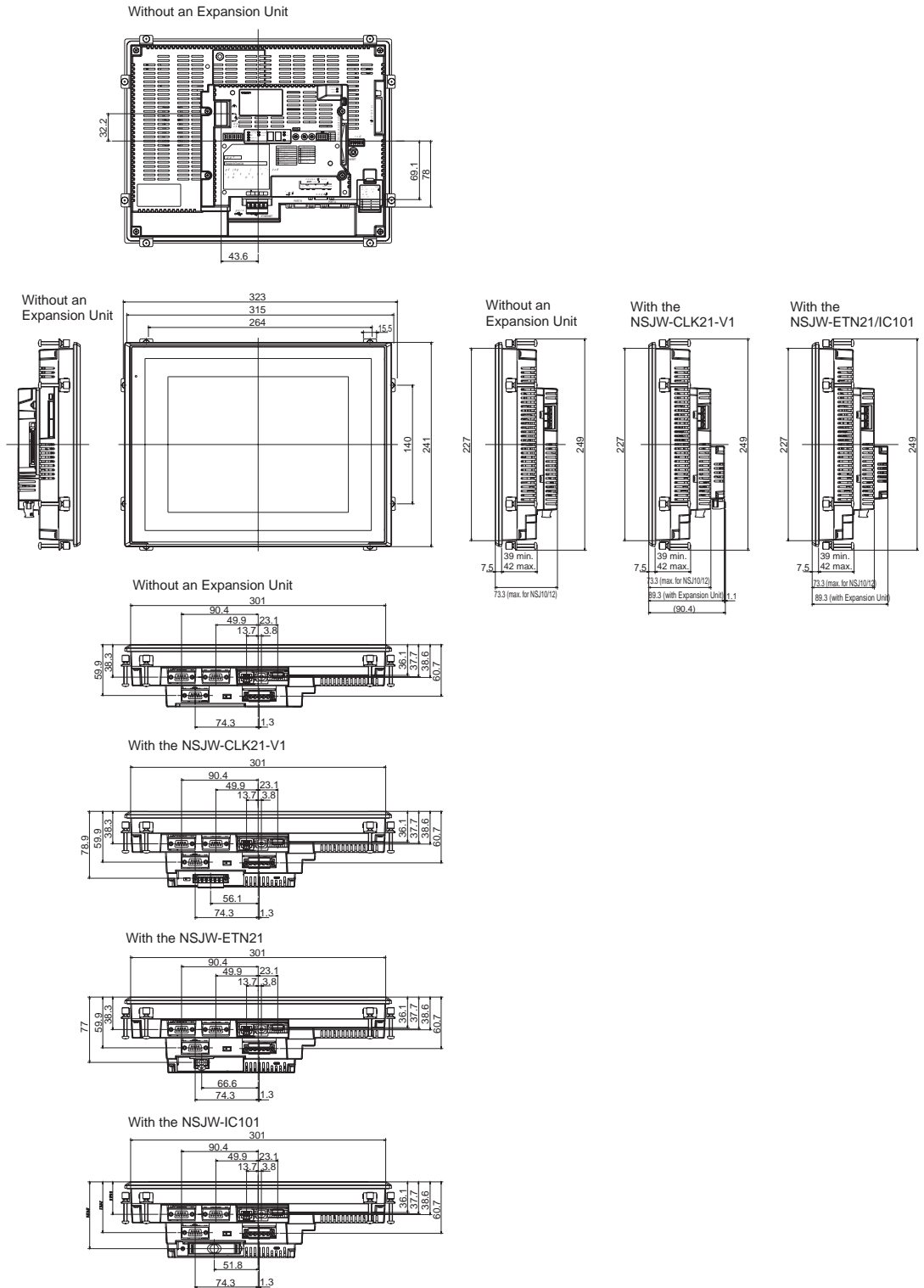

NSJ8-TV0□(B)-□□□□

Without an Expansion Unit

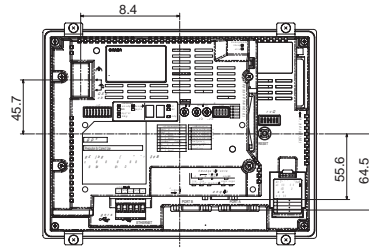

Without an Expansion Unit

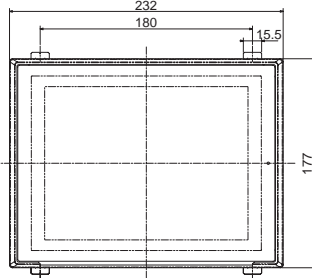
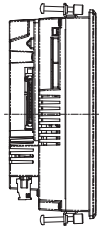

Without an Expansion Unit

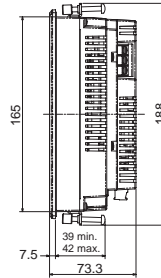

With the NSJW-CLK21-V1

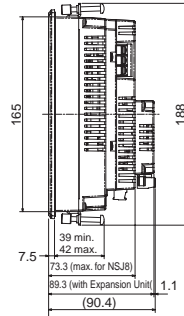

With the NSJW-ETN21/IC101

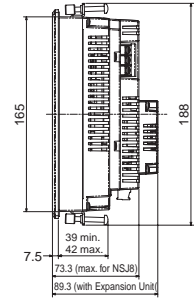

Without an Expansion Unit

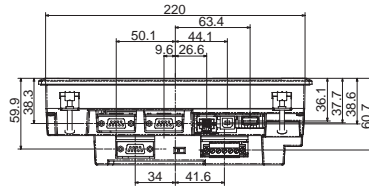

With the NSJW-CLK21-V1

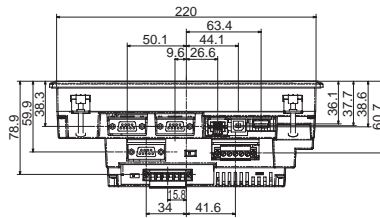

With the NSJW-ETN21

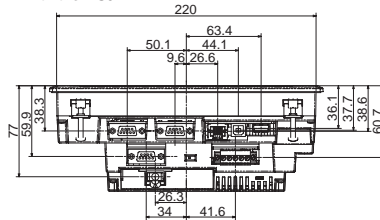

With the NSJW-IC101

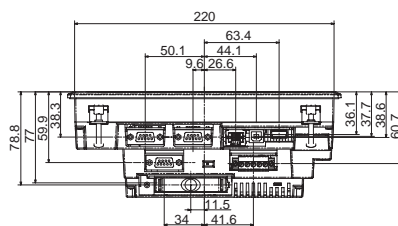



NSJ5-SQ□□(B)-□□□ and NSJ5-TQ□□(B)-□□□

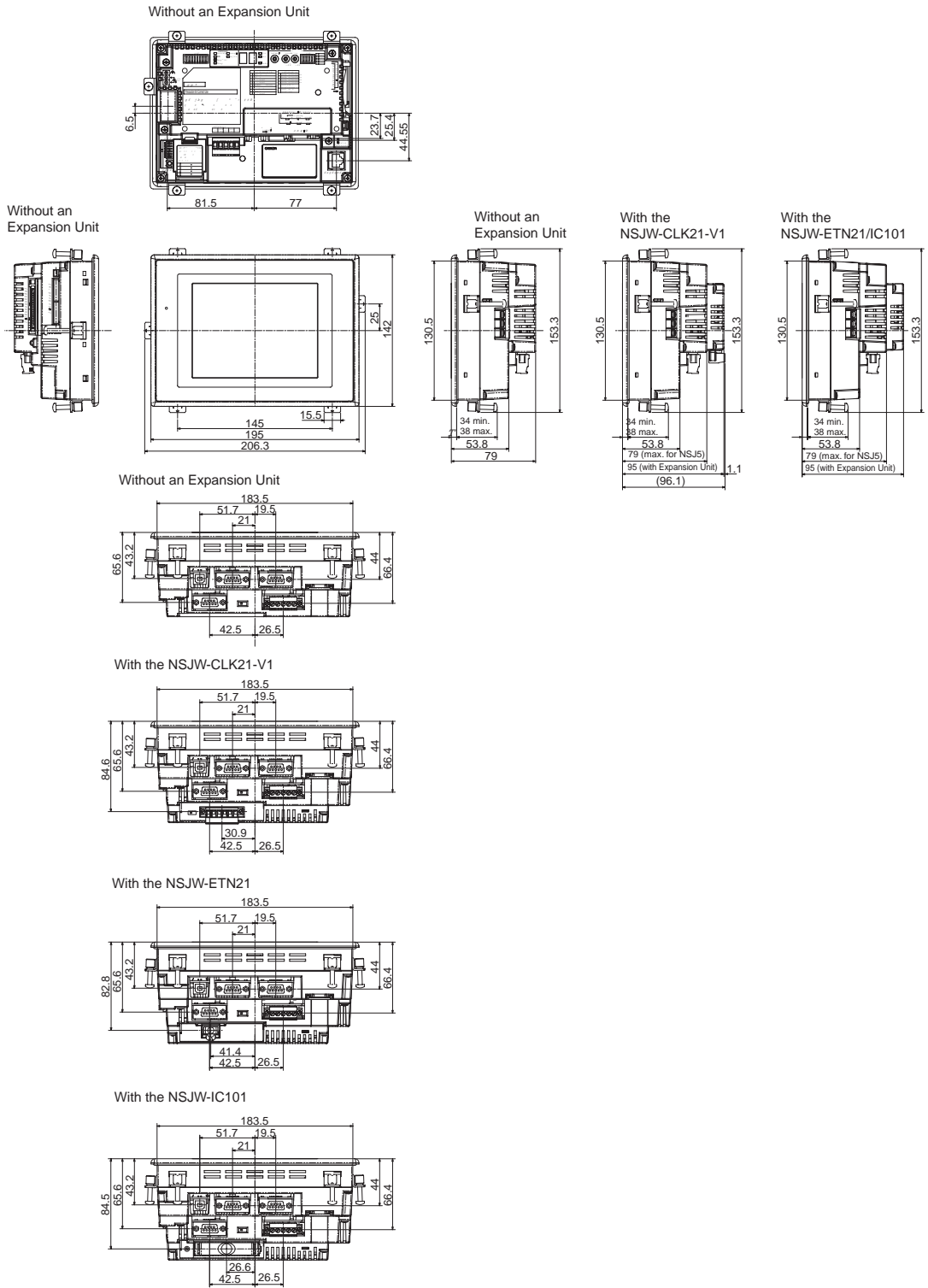

**Expansion Units**

**NSJW-IC101 (NSJ I/O Control Unit)**

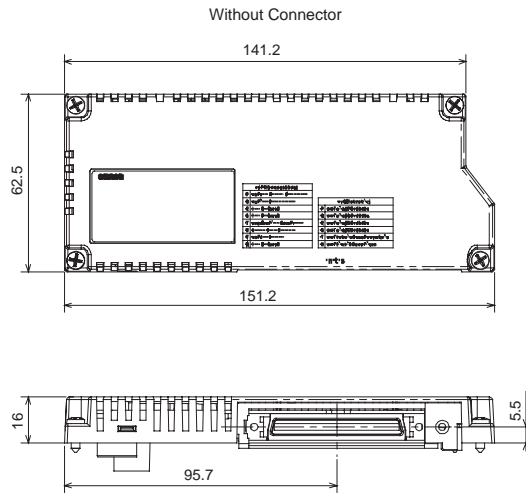

**NSJW-CLK21-V1 (NSJ Controller Link Unit)**

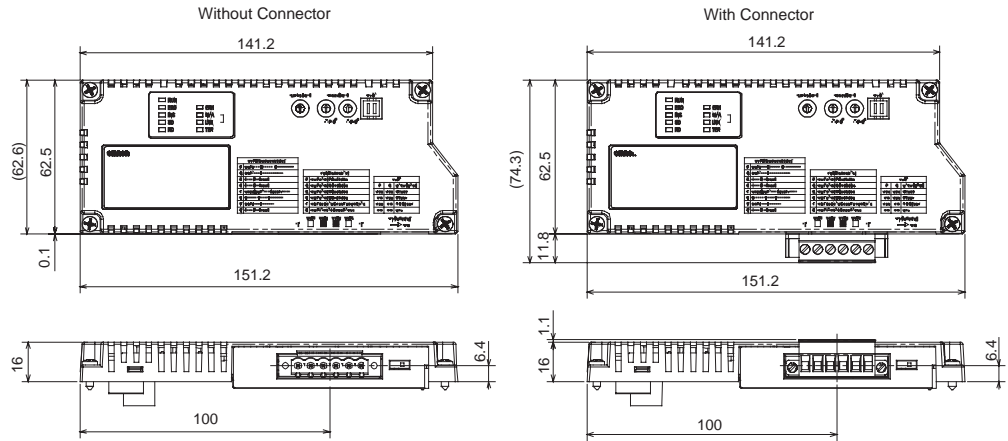

**NSJW-ETN21 (NSJ Ethernet Unit)**

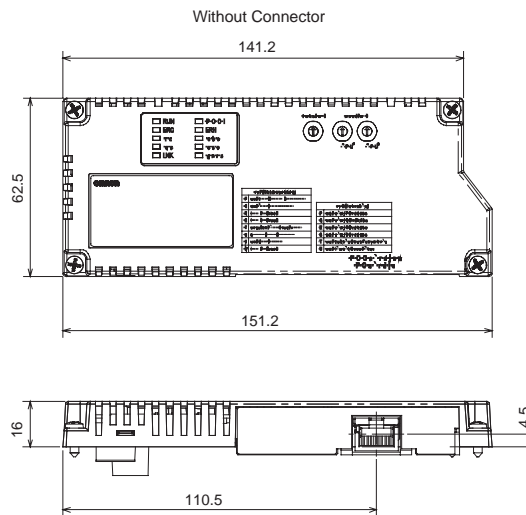

# SECTION 5

## Installation and Wiring

This section described how to install and wire the NSJ-series NSJ Controller.

5-1	Installation . . . . .	92
5-1-1	Fail-safe Circuits . . . . .	92
5-1-2	Installation and Wiring Precautions . . . . .	93
5-1-3	Mounting the NSJ Controller to the Control Panel . . . . .	93
5-2	Wiring . . . . .	94
5-2-1	Connecting the Power Supply . . . . .	94
5-2-2	Wiring the Ground Wire . . . . .	95
5-2-3	Connecting the Built-in RS-232C Ports . . . . .	96
5-2-4	DeviceNet Wiring . . . . .	96
5-3	Mounting and Wiring Expansion Units . . . . .	101
5-3-1	Mounting an Expansion Unit . . . . .	101
5-3-2	Wiring an NSJ I/O Control Unit . . . . .	101
5-3-3	Wiring the NSJ Controller Link Unit . . . . .	104
5-3-4	Wiring the NSJ Ethernet Unit . . . . .	108

## 5-1 Installation

This section describes installing the NSJ Controller in a control panel, wiring the power supply, wiring the built-in DeviceNet Section, and mounting/wiring Expansion Units.

### 5-1-1 Fail-safe Circuits

Be sure to set up safety circuits outside of the Controller Section to prevent dangerous conditions in the event of errors in the NSJ Controller or external power supply. Pay particular attention to the following items.

#### Supply Power to the NSJ Controller before the Control System

If the NSJ Controller's power supply is turned ON after the controlled system's power supply, outputs in Units such as DC Output Units may malfunction momentarily. To prevent any malfunction, add an external circuit that prevents the power supply to the controlled system from going ON before the power supply to the NSJ Controller itself.

#### Managing NSJ Controller Errors

When any of the following errors occurs, NSJ Controller operation will stop and all outputs from Output Units will be turned OFF.

- Operation of the Power Supply Unit's overcurrent protection circuit
- A CPU error (watchdog timer error) or CPU on standby
- A fatal error\* (memory error, I/O bus error, duplicate number error, too many I/O points error, program error, cycle time too long error, or FALS(007) error)

Be sure to add any circuits necessary outside of the NSJ Controller to ensure the safety of the system in the event of an error that stops NSJ Controller operation.

**Note** \*When a fatal error occurs, all outputs from Output Units will be turned OFF even if the IOM Hold Bit has been turned ON to protect the contents of I/O memory. (When the IOM Hold Bit is ON, the outputs will retain their previous status after the Controller Section has been switched from RUN/MONITOR mode to PROGRAM mode.)

#### Managing Output Unit Malfunctions

It is possible for an output to remain ON due to a malfunction in the internal circuitry of the Output Unit, such as a relay or transistor malfunction. Be sure to add any circuits necessary outside of the NSJ Controller to ensure the safety of the system in the event that an output fails to go OFF.

### 5-1-2 Installation and Wiring Precautions

Be sure to consider the following factors when installing and wiring the NSJ Controller to improve the reliability of the system and make the most of the NSJ Controller's functions.

#### Ambient Conditions

Do not install the NSJ Controller in any of the following locations.

- Locations subject to drastic temperature changes or condensation.
- Locations subject to temperatures or humidity outside the range specified in the specifications.
- Locations subject to high humidity and the possibility of condensation.
- Locations subject to exposure to chemicals.
- Locations subject to exposure to oil.
- Locations subject to corrosive or flammable gases.
- Locations subject to shock or vibration.
- Locations outdoors subject to direct rain or wind.
- Locations subject to strong ultraviolet light.
- Locations subject to excessive dust and dirt.
- Locations subject to direct sunlight.

Be sure to enclose or protect the NSJ Controller sufficiently in the following locations.

- Locations subject to static electricity or other forms of noise.
- Locations subject to strong electromagnetic fields.
- Locations close to power lines.
- Locations subject to possible exposure to radioactivity.

### 5-1-3 Mounting the NSJ Controller to the Control Panel

The NSJ Controller is normally flush-mounted to a control panel. Use a type I enclosure.

The NSJ Controller is mounted using the panel mounting brackets provided with the NSJ Controller, and tools, such as a Phillips screwdriver.

Use the following procedure to mount the NSJ Controller to the control panel.

**1,2,3...**

1. Make a hole in the panel for flush mounting according to the following dimensions.

Recommended panel thickness: 1.6 to 4.8 mm

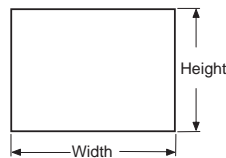

Model	Dimensions
NSJ12	Width 302 $^{+1}_0$ Height 228 $^{+1}_0$ mm
NSJ10	Width 302 $^{+1}_0$ Height 228 $^{+1}_0$ mm
NSJ8	Width 220.5 $^{+0.5}_0$ Height 165.5 $^{+0.5}_0$ mm
NSJ5	Width 184 $^{+0.5}_0$ Height 131 $^{+0.5}_0$ mm

2. Insert the NSJ Controller from the front of the panel.

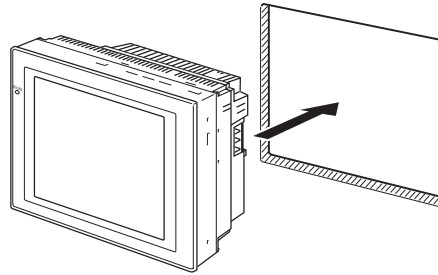

3. Secure NSJ Controller to the panel using the panel mounting brackets from the back of the panel, as shown in the following diagram, tightening the screws evenly to the specified torque. The front sheet may become distorted if the tightening torque is more than the specified limit or not uniform. Tightening torque required for water resistance: 0.5 to 0.6 N·m.

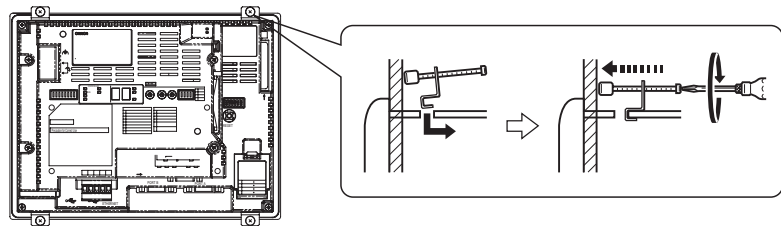

- Note**
- (1) Do not allow metal particles to enter the NSJ Controller while work is being performed on the panel.
  - (2) The allowable thickness of the panel for mounting is between 1.6 and 4.8 mm.
  - (3) Secure the mounting bracket with a uniform tightening torque of between 0.5 and 0.6 N·m to keep the NSJ Controller waterproof and dustproof. The front sheet may become distorted if the tightening torque is more than the specified limit or not uniform. Always use a panel that is clean, undistorted, and strong enough to adequately withstand mounting the NSJ Controller.

## 5-2 Wiring

### 5-2-1 Connecting the Power Supply

Connect a 24-VDC power supply to the power input terminals.

- Note**
- (1) Do not connect an AC power supply to the power terminals.
  - (2) Use a DC power supply with low voltage fluctuation.
  - (3) Do not perform a dielectric strength test.
  - (4) Use a DC power supply that will provide a stable output even if the input is momentarily interrupted for 10 ms, and which has reinforced or double insulation.

### Power Supply

The following table shows the specifications for the power supply that can be connected. Determine power supply specifications that meet the power supply capacity requirements.

Item	Value
Power supply voltage	24 VDC
Allowable voltage range	20.4 to 27.6 VDC (24 VDC ±15%)
Power supply capacity	NSJ5-TQ□□-□□□: 22 W min. NSJ5-SQ□□-□□□: 21 W min. NSJ8-TV□□-□□□: 30 W min. NSJ10-TV□□-G5D: 30 W min. NSJ12-TS□□-G5D: 30 W min.

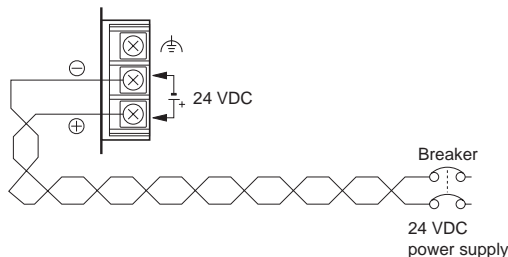

### Parts Used to Connect the Power Supply

**Note** Connect power to the power terminal block using twisted-pair power lines with a cross-sectional area of at least 2 mm<sup>2</sup> and always using M3.5 crimp terminals. The correct tightening torque for the terminal block is 0.8 N·m. Tighten terminal block screws properly.



### Recommended Products

Manufacturer	Model number of forked terminals	Model number of round terminals	Applicable power lines (twisted-pair)
J.S.T. Mfg. Co., Ltd.	2-YS3A	2-3.5	2.0 to 2.63 mm <sup>2</sup>
Fuji Terminal Industry Co., Ltd.	2-YAS3.5	V2-S3.5	

**Note** When surge noise occurs in the DC power supply, connect a Transistor Voltage Suppressor (TVS) between the 24-V and 0-V DC terminals. Recommended TVS model: 1.5KE33CA  
Manufacturers: Vishay Semiconductor, ST Microelectronics

### 5-2-2 Wiring the Ground Wire

The NSJ Controller is provided with a functional ground (FG: ⊕) terminal. Wire the FG terminal according to the following conditions.

- 1,2,3...
1. Ground according to the figure when there is difference in potential between the NSJ Controller and other hosts. Do not ground the functional ground of the NSJ Controller if it is far from the host and one-point grounding is difficult.

- Do not ground the functional ground (FG: ) of the NSJ Controller if it is mounted to the same panel as devices that generate noise, such as motors and inverters.

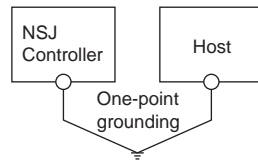

### 5-2-3 Connecting the Built-in RS-232C Ports

The NSJ Controller provides three RS-232C ports. This section describes the application and connection methods of these ports.

#### Serial Port C (Controller Section)

Serial port C (on the Controller Section) has the same functionality as the RS-232C port on a CJ1-H CPU Unit with unit version 3.0 except that a Programming Device cannot be connected to serial port C. Refer to the following portions of the *CJ Series PLC Operation Manual (W393)* for connection methods: *Appendix F Connecting to the RS-232C Port on the CPU Unit* and *Appendix G CJ1W-CIF11 RS-422A Converter*.

#### Serial Ports A and B (Display Section)

These ports have the same functionality as the RS-232C port on an NS-series PT. A Programming Device can be connected. Refer to the following portions of the *NS-Series PT Setup Manual (V083)* for connection methods: *Appendix 4 Using NS-AL002 RS-232C/RS-422A Converters*, *Appendix 5 Preparing Connecting Cables*, *Appendix 6 Preparing Cables for Computer Connection*, and *Appendix 7 Preparing Connecting Cables for Bar Code Readers*.

**Note** Observe the following precautions when using the NS-AL002 with an NSJ Controller.

- The NS-AL002 cannot be connected to serial port C.
- Due to space limitations, the NS-AL002 cannot be simultaneously connected to both serial ports A and B.
- Due to space limitations with the NSJ5, serial port C cannot be used if the NS-AL002 is connected to serial port A.
- Due to space limitations with the NSJ8, NSJ10, and NSJ12, serial port C cannot be used if the NS-AL002 is connected to serial port A or to serial port B.

### 5-2-4 DeviceNet Wiring

This section describes the wiring of only the connection to the built-in DeviceNet Section. Refer to the *DeviceNet Operation Manual (W267)* for information on communications cables/models, slave connections, and wiring precautions.

#### Communications Cables

In a DeviceNet system, Special Thin/Thick Cable (5-conductor) or Flat Cable (4-conductor) that conforms to DeviceNet specifications must be used. The cable's characteristics affect DeviceNet communications, so cable that is not within DeviceNet specifications cannot be used. Always use the Special Thin/Thick Cable or Flat Cable.

There are two kinds of special cable: Thick Cable and Thin Cable.



Refer to the *DeviceNet Operation Manual (W267)* for information on cables with shielded connectors.

Cable	Model	Specifications
Thick Cable	DCA2-5C1	Outer diameter: 11.6 mm Length: 100 m (See note.)
Thin Cable	DCA1-5C10	Outer diameter: 7 mm Length: 100 m (See note.)
Flat Cable	DCA4-4F10	Outer diameter: 10.16 × 2.54 mm Length: 100 m

**Note** OMRON Thick Cables and Thin Cables are available in lengths of 100 m. Consult with your OMRON representative for other cable lengths.

**Wiring Communications Cables**

The following procedure shows how to wire using Special Thin/Thick Cable. Refer to the *DeviceNet Operation Manual (Cat. No. W267)* for the procedure for Flat Cable.

Use the following procedure to prepare and connect the communications cables to the connectors.

1,2,3...

- Strip about 30 mm of the cable sheathing, being careful not to damage the woven shield just below the sheathing. Do not remove more than about 30 mm; removing too much of the covering can result in short circuits or allow noise into the Network.

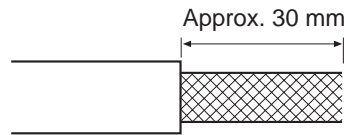

- Carefully peel back the woven shield. There is a bare shield wire under the woven shield as well as the signal lines and power lines. (The shield wire will be loose on the outside of the other lines, but it is stiffer than the woven shield and easy to identify by touch.)

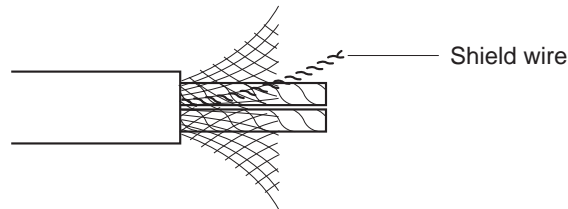

- Cut away the exposed woven shield, remove the aluminum tape from the signal and power lines, and strip the sheath from the signal and power lines to the proper length for the crimp terminal connectors. Twist together the stranded wires of each signal and power lines.

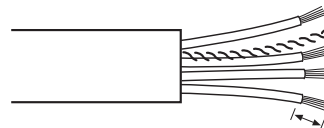

Strip proper length for the terminals being used.

- Attach the crimp terminals (solderless pin terminals) to the lines and use the proper Crimping Tool to crimp the terminal securely.

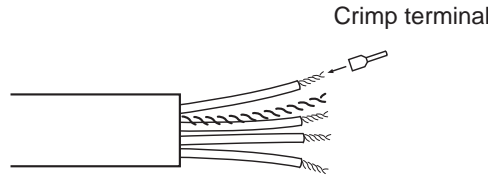

**Note** We recommend using the following crimp terminals and crimping tools.

Model	Crimping tool	Specifications	Remarks
AI Series AI 0.5-6WH: For thin cable power lines AI 0.25-6BU: For thin cable signal lines AI 0.5-10WH: For thin cable power lines AI 0.25-8YE: For thin cable signal lines AI 2.5-8BU: For thick cable AI 2.5-12BU: For thick cable	CRIMPFOX UD6 or CRIMP- FOX ZA3	For a single wire	PHOENIX CONTACT
AI Series AI TWIN2 × 0.5-8WH (for thin cable)		For two wires (multi-drop)	
H0.5/16.5 ZH		For two wires (multi-drop)	Weidmuller

- Cover the end of the cable with vinyl tape or heat-shrink tubing as shown in the following diagram.

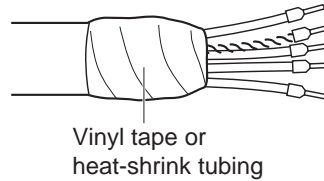

- Check that the connector is oriented correctly and the wire set screws are loose enough to insert the wires. Insert the power lines, signal lines, and shield wire in the correct holes in the following order (left to right): black, blue, shield, white, and red.

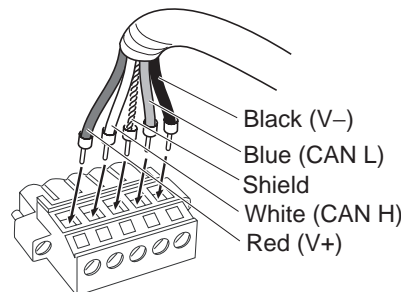

- Note**
- Be sure that the wire set screws are sufficiently loosened before attempting to insert the lines. If these screws are not loose, the wires will go into the space in the back of the connector and cannot be locked with the set screws.
  - There are colored stickers provided on the connector and board that match the colors of the lines to be inserted. Be sure that the colors match when wiring the connectors.

(3) The following table shows the cable colors:

Color	Signal	Symbol
Red	Communications power supply, positive	V+
White	Signal line, High	CAN H
---	Shield	DRAIN
Blue	Signal line, Low	CAN L
Black	Communications power supply, negative	V-

- Tighten the connector's set screws on the wires using a slotted screwdriver that doesn't taper at the tip, which will prevent the screwdriver from binding in the connector. Tighten the screws to a torque of between 0.25 and 0.3 N·m

When using thick cable, provide some slack in the cable so that the connectors do not pull out because of tension on the cable.

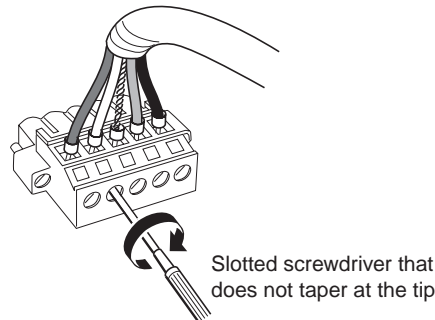

**Note** The OMRON XW4Z-00C Screwdriver is suitable for tightening the DeviceNet connector's set screws. The following diagram shows the shape of the XW4Z-00C screwdriver.

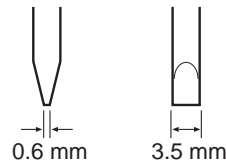

- Align the connector on the cable with the connect on the NSJ Controller and press it firmly to the back. Then tighten the screws on both sides of the connector to a torque of 0.25 to 0.3 N·m.

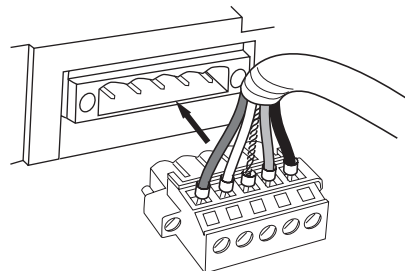

**Multi-drop Wiring Methods**

There is not sufficient space to connect a multi-drop connector to the NSJ12-TS0□(B)-G5D, NSJ10-TV0□(B)-G5D, and NSJ8-TV0□(B)-□□□. To use a multi-drop connection, use a standard square connector and a T-branch Tap.

### Multi-drop Connection with a Multi-drop Connector

A multi-drop connect also cannot be used with serial port B on the NSJ5-TQ□□(B)-□□□ and NSJ5-SQ□□(B)-□□□. To use a multi-drop connection, use a standard square connector and a T-branch Tap.

The following OMRON Multi-drop Connectors (sold separately) can be used to make a multi-drop connection with Thick Cable.

- XW4B-05C4-T-D Straight Multi-drop Connector without Attachment Screws
- XW4B-05C4-TF-D Straight Multi-drop Connector with Attachment Screws
- XW4G-05C4-TF-D Straight Multi-drop Clamp Connector with Attachment Screws

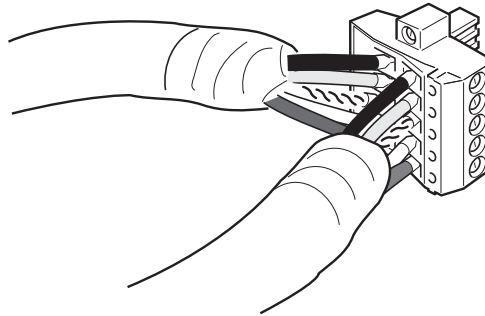

#### Note

- (1) Before connecting the communications cables, turn OFF the power supplies to the NSJ Controller and all Slaves, as well as the communications power supplies.
- (2) Use crimp terminals for wiring.
- (3) Use the proper crimping tool and crimping methods when attaching crimp terminals. Consult the manufacturer of the tools and terminals you are using. Inappropriate tools or methods can result in broken wires.
- (4) Be extremely careful to wire all signal lines, power lines, and shielding wire correctly.
- (5) Tighten all set screws firmly. Tighten to a torque of between 0.25 and 0.3 N·m.
- (6) Wire the signal lines, power lines, and shielding wire so that they do not become disconnected during communications.
- (7) Do not pull on the communications cables. They may become disconnected or wires may break.
- (8) Allow a sufficient bending radius in cable turns so that communications cables are not bent too sharply. The Cables may become disconnected or wires may break if the cables are bent too far.
- (9) Never place objects on top of the communications cables. They may break.
- (10) Double-check all wiring before turning ON the power supply.

## 5-3 Mounting and Wiring Expansion Units

### 5-3-1 Mounting an Expansion Unit

Remove the sticker from the Expansion Unit connector, connect the Expansion Unit to the Expansion Unit connector, and tighten the four screws. Then attach the sticker provided with the NSJ Controller to the location shown in the figure.

- 1,2,3... 1. Remove the sticker from the Expansion Unit connector.

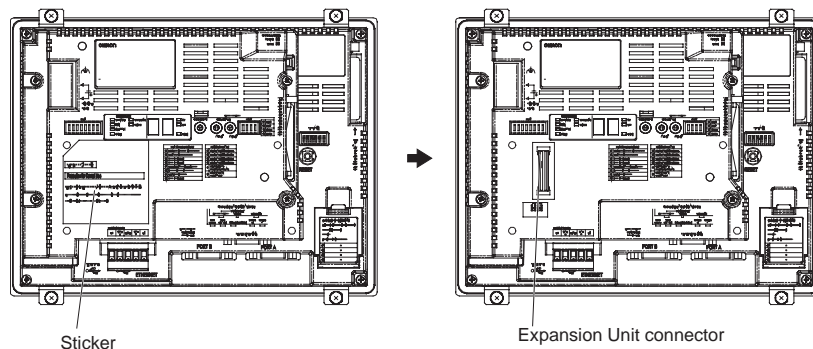

2. Connect the Expansion Unit to the Expansion Unit connector and tighten the four screws. Then attach the sticker provided with the NSJ Controller to the location shown in the figure.

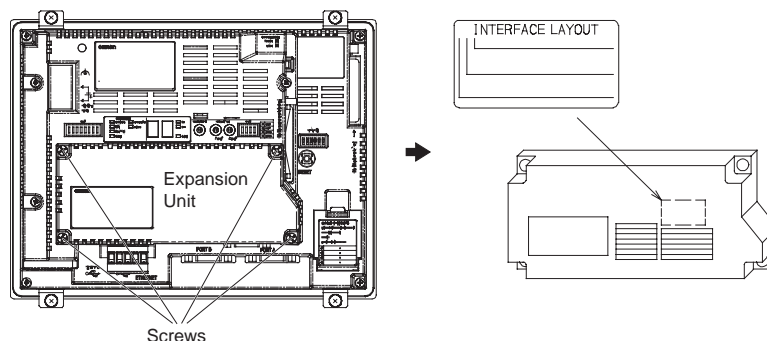

- Note**
- (1) Always correctly tighten the enclosed screws after connecting the Expansion Unit to the connector. The correct tightening torque is 0.4 N·m.
  - (2) Always turn OFF the power supply before attaching or removing the Expansion Unit.
  - (3) Attaching an Expansion Unit will increase the depth of the NSJ Controller by 16 mm. Be sure to provide sufficient space in the control panel. Refer to 4-2-1 Dimensions for details.

### 5-3-2 Wiring an NSJ I/O Control Unit

CS/CJ-series I/O Connecting Cables are used to connect an NSJ Controller with an NSJ I/O Control Unit and CJ-series Expansion Racks.

#### CS/CJ-series I/O Connecting Cables

- The CS/CJ-series I/O Connecting Cables have connectors with a simple lock mechanism are used to connect the NSJ Controller to an Expansion Rack or to connect two Expansion Racks.

Model number	Cable length
CS1W-CN313	0.3 m
CS1W-CN713	0.7 m

Model number	Cable length
CS1W-CN223	2 m
CS1W-CN323	3 m
CS1W-CN523	5 m
CS1W-CN133	10 m
CS1W-CN133B2	12 m

- Use CS/CJ-series I/O Connecting Cable to connect the NSJ I/O Control Unit on an NSJ Controller to the I/O Interface Unit on a CJ-series Expansion Rack and to connect the I/O Interface Units on adjacent CJ-series Expansion Racks.

NSJ I/O Control Unit: NSJW-IC101

CJ-series I/O Interface Unit: CJ1W-II101

- Install the Racks and select I/O Connecting Cables so that the total length of all I/O Connecting Cables does not exceed 12 m.
- The following diagram shows where each CSCJ-series I/O Connecting Cable must be connected on each Rack. The Rack will not operate if the cables aren't connected properly.

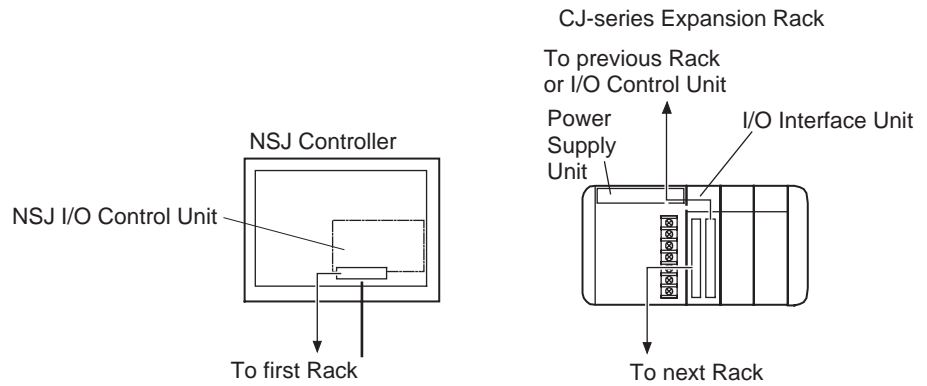

**Cable Connections**

- The following diagram shows examples of proper Rack connections. Connect the simple lock connectors to the I/O Control Unit on the NSJ Controller and the I/O Interface Units on the CJ-series Expansion Racks.
- The top and bottom of the connector are different. Be sure the connector is facing the correct direction before connecting it.

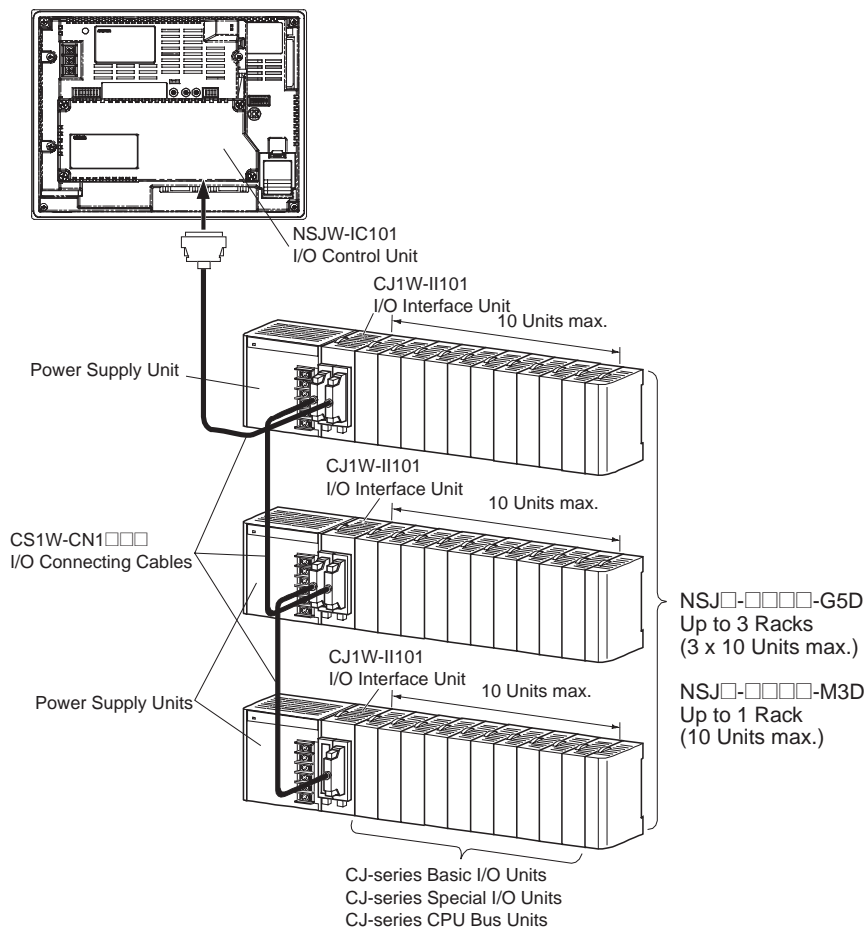

- Note**
- (1) I/O Interface Unit must be connected immediately to the right of the Power Supply Unit.
  - (2) The total length of CS/CJ-series I/O Connecting Cable connecting the NSJ I/O Control Unit on the NSJ Controller to the I/O Interface Unit on the first CJ-series Expansion Rack and connecting the I/O Interface Units on adjacent CJ-series Expansion Racks must be 12 m or less.

**Connecting the Simple Locking Connectors**

Press the tabs on the end of the connector and insert the connector until it locks in place. The NSJ Controller will not operate properly if the connector isn't inserted completely.

To remove the connector, press the tabs and pull the connector out.

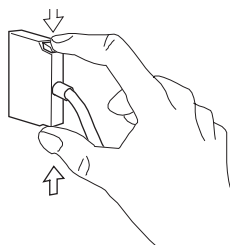

- Note**
- (1) Always turn OFF the power supply to the NSJ Controller before connecting a cable.
  - (2) An I/O bus error will occur and the NSJ Controller will stop if a CS/CJ-series I/O Connecting Cable's connector separates from the Rack. Be sure that the connectors are secure.
  - (3) A 63-mm hole will be required if the CS/CJ-series I/O Connecting Cable must pass through a hole when connecting an Expansion Rack.
  - (4) Do not bend or pull on the cables with excessive force.
  - (5) The cables can withstand a pulling force up to 49 N.
  - (6) The CS/CJ-series I/O Connecting Cables mustn't be bent beyond the minimum bending radii shown in the following diagram.

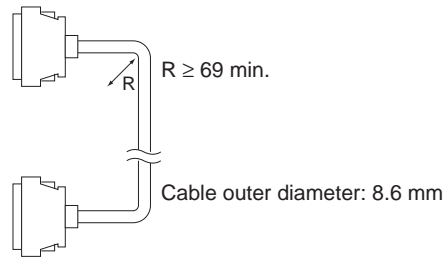

- (7) Always attach the cover to the output connector (left side) on the last I/O Interface Unit on the last CJ-series Expansion Rack to protect it from dust.

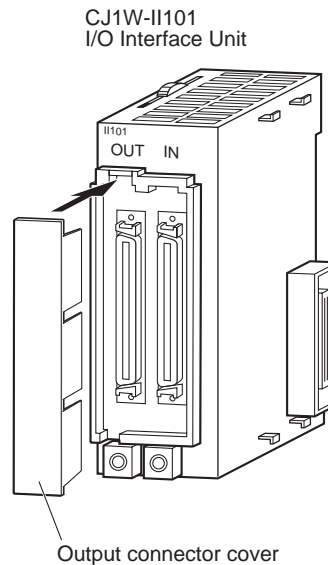

Refer to *Section 5 Installation and Wiring* in the *CJ Series PLC Operation Manual (W393)* for CJ-series Unit connections/wiring, DIN Track mounting methods, and Power Supply Unit wiring.

### 5-3-3 Wiring the NSJ Controller Link Unit

This section describes methods for wiring only the connector on the NSJ Controller Link Unit. Refer to the *Controller Link Units Operation Manual (W309)* for information on communications cables, shield wiring, and connection precautions.



**Communications Cables**

Use the following shielded twisted-pair cables for Controller Link connections.

Model	Manufacturer
ESVC 05X2C-13262	BANDO ELECTRIC WIRE
ESNC 05X2C-99-087B	Nihon Electric Wire & Cable

**Note** Always use one of the above communications cables. Normal communications may not be possible if any other cables are used.

**Wiring the Communications Cable**

- Note**
- (1) Use the cable specified for the communications cable.
  - (2) Keep communications cables separated from power lines or high-tension lines to prevent influences from electronic noise.
  - (3) Ground the shield of the communications cable at one end of the network. Do not ground the shield at both ends.
  - (4) Do not connect the shield cable of the communications cable to a ground that is also being used for power-system devices, such as inverters.
  - (5) Turn ON the terminating resistance switch at the node at each end of the network and turn OFF the terminating resistance switch at all other nodes.
  - (6) Do not run wiring outdoors. If outdoor wiring is necessary, take protective measures against lightening, such as underground wiring or wiring inside pipes.
  - (7) The minimum length of the communications cable between nodes is 1 m. Prepare the communications cables at a length of 1 m or longer.
  - (8) Use the multidrop method for connecting nodes. Normal communications will not be possible with T branches.

Connect the communications cable to the connector using the following procedure.

- 1,2,3...**
1. Taking care not to damage the mesh of the shield, strip about 50 mm off the end of the cable. Do not strip the cable too far because it may cause a short-circuit.

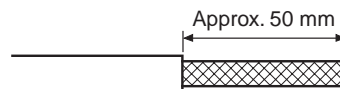

- At the end connected to the node, twist the mesh of the shield into a single wire. Leave sufficient length at the tip of the twisted shield to be connected to a crimp terminal and cover the remaining section with heat-shrink tubing. Cut all the shield mesh off at the end not connected to the node.

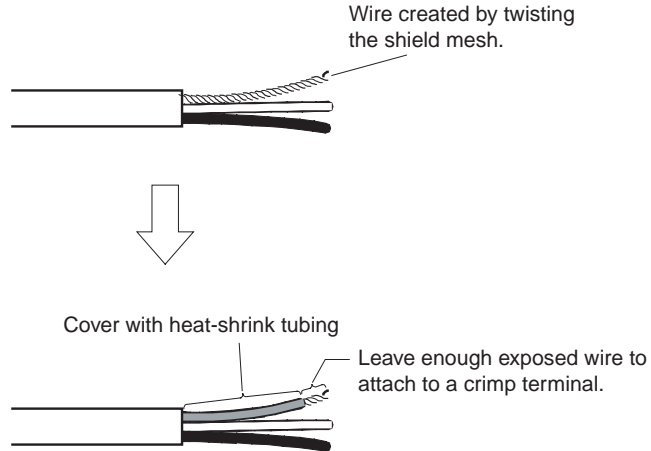

- Strip the ends of the signal wires far enough to attach to the crimp terminals. Twist the wire strands together.



- Cover the end of the cable at the point it was stripped to in step 1 with vinyl tape or heat-shrink tubing.

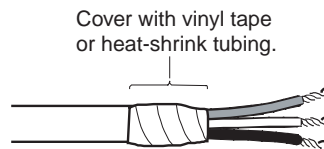

- Attach crimp terminals to the shield wire and signal wires. Cover the connections with vinyl tape or heat-shrink tubing.

**Note** We recommend the Phoenix AI-series crimp terminals shown in the following diagram. Phoenix's ZA3 crimping tool can be used to attach these terminals.

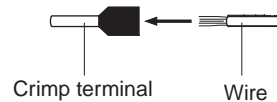

Insert the wire and crimp the terminal to the wire.

- Carefully insert the signal and shield lines into the respective holes of the connector (identified with the markings). Ensure that the connector is oriented correctly. The following example is for connection to a Board in the middle of the network.

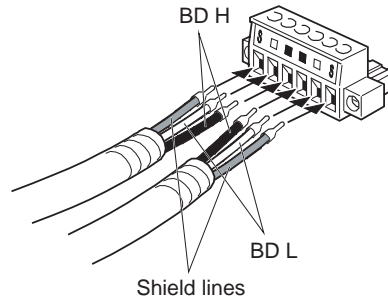

- Note**
- Attach crimp terminals to the wires. Never connect bare power supply wires directly to the connector.
  - Marks are provided on the connector for the signal lines. Connect the signal lines according to the marks.

Making	Signal name	Line color
■	BD H (communications data high)	Black
□	BD L (communication data low)	White
S	SHLD (shield)	---

- Marks indicate signals as listed above.
  - The lines can be connected to either the right or left half of the connector at the node on either end of the network.
- Firmly secure each signal line with the signal line screws in the connector. An ordinary flat-blade screwdriver with a tip that tapers at the end is not suitable because it cannot be inserted far enough. Use a small flat-blade screwdriver with a uniform width. The applicable tightening torque is 0.25 to 0.3 N·m.

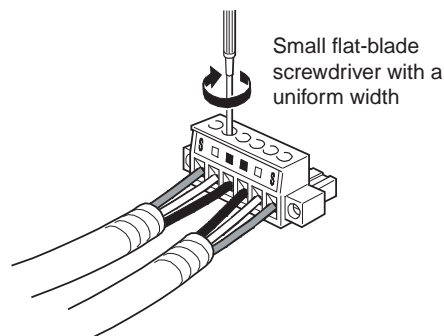

- Note** The following screwdriver is available from OMRON.  
Model XW4Z-00C

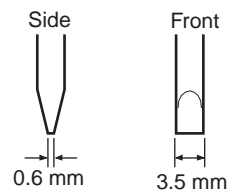

- Insert the connector on the communications cable into the connector on the Board as shown below.

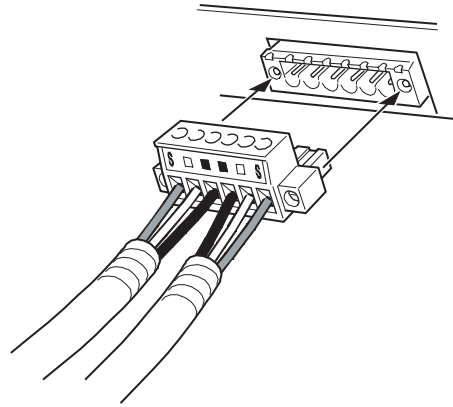

- Secure the connector to the Board by tightening the screws on the connector. The applicable tightening torque is 0.25 to 0.3 N·m.

**Communications Connector**

As shown below, like terminals are connected internally in the connector on the NSJ Controller Link Unit. If the communications connector is removed from the Unit, the communications line will be broken and communications will no longer be possible. If it is necessary to add or remove nodes during operation, use a Repeater Unit.

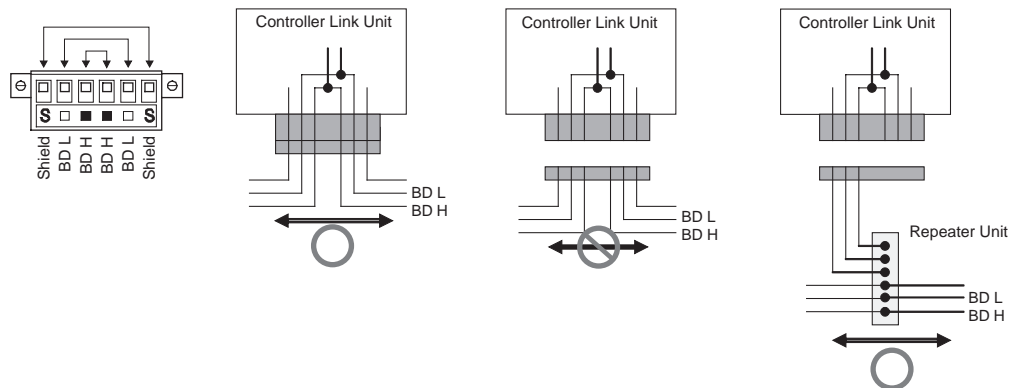

**5-3-4 Wiring the NSJ Ethernet Unit**

Refer to 2-4 Network Installation and 2-5 Connecting to the Network in the Ethernet Units Construction of Networks Operation Manual (W420) for information on laying networks and network connections.

**Precautions on Network Installation**

- An Ethernet network must be installed with sufficient safety measures and according to standards. Refer to JIS X5252 for Ethernet installation and to *Technical Standards for Electric Equipment* or equivalent local standards for installation work.
- We strongly recommend that installation work be requested from a professional with a detailed knowledge of safety measures and standards.
- Do not install Ethernet equipment near sources of noise. If noise-prone environments are unavoidable, be sure to take adequate measures against noise interference, such as installing network components in grounded metal cases, using optical links in the system, etc.

**Ethernet Connectors**

The following standards and specifications apply to the connectors for the Ethernet twisted-pair cable.

- Electrical specifications: Conforming to IEEE802.3 standards.
- Connector structure: RJ45 8-pin Modular Connector (conforming to ISO 8877)

**Connecting Connectors**

- 1,2,3...**
1. Lay the twisted-pair cable.
  2. Connect the cable to the hub. Be sure to press in the cable until it locks into place. Request cable installation from a qualified professional.
  3. Connect the cable to the connector on the Ethernet Unit. When connecting to a hub or Ethernet connector, be sure to press in the cable until it locks into place.

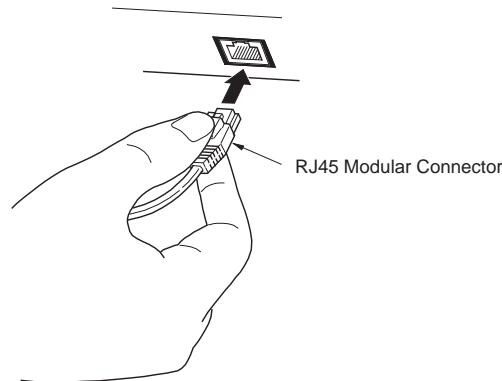



# SECTION 6

## PLC Setup and I/O Allocations

This section provides information on functionality added in the following areas to the NSJ Controllers in comparison to the functionality of CJ-series PLCs. Refer to the *CJ Series PLC Operation Manual (W393)* for all information not given here.

- PLC Setup
- I/O Allocations
- I/O Memory

6-1	PLC Setup . . . . .	112
6-2	I/O Allocations . . . . .	112
6-3	I/O Memory . . . . .	112
6-3-1	CPU Bus Unit Area . . . . .	113
6-3-2	Display Section Status Area . . . . .	114
6-3-3	Special I/O Unit Area . . . . .	115
6-3-4	DeviceNet Area . . . . .	115
6-3-5	Auxiliary Area . . . . .	117

## 6-1 PLC Setup

The PLC Setup allows the user to define basic specifications for NSJ Controller operation using software settings. The PLC Setup is thus used to make various settings for the NSJ Controllers.

Only the following setting for a startup condition has been added to the NSJ Controller. Refer to *SECTION 7 PLC Setup* in the *CJ Series PLC Operation Manual (W393)* for other settings in the PLC Setup.

### Execution Settings on the CX-Programmer's Startup Tab Page

#### Startup Condition

Settings	Function	Related flags and words	When setting is read
0: Don't wait for Display Section. 1: Wait for Display Section. Default: 0	The default setting can be changed to make the Controller Section wait until Display Section initialization has been completed before starting operation. If the setting is changed to make the Controller Section wait, the Controller Section will be in CPU standby status until operation starts.	---	When the power is turned ON

**Note** The startup condition setting for CS1-H CPU Units (word 83, bit 15) is invalid for NSJ Controllers.

## 6-2 I/O Allocations

When using CJ-series Expansion Racks with the NSJ Controller, refer to *Section 8 I/O Allocations* in the *CJ Series PLC Operation Manual (W393)* for information on I/O allocations to CJ-series Basic I/O Units, creating I/O tables, and reserving words for future use. Refer to *6-3 I/O Memory* in this manual or information on I/O allocations to CJ-series Special I/O Units and CJ-series CPU Bus Units.

A Programming Console cannot be connected to the NSJ Controller. Always use the CX-Programmer for programming, setup, and monitor operations.

## 6-3 I/O Memory

This section describes the following areas in the NSJ Controller.

- CPU Bus Unit Area: CIO 1500 to CIO 1899 (400 words) (Used by the built-in DeviceNet Section and the following Expansion Units: NSJ Controller Link Unit and NSJ Ethernet Unit.)
- Display Section Status Area: CIO 1900 to CIO 1999 (100 words)
- Special I/O Unit Area: CIO 2000 to CIO 2959 (960 words)
- DeviceNet Area (Used by the built-in DeviceNet Section.): CIO 3200 to CIO 3799 (600 words)
- Auxiliary Area

Refer to *Section 9 Memory Areas* in the *CJ Series PLC Operation Manual (W393)* for information on other parts of I/O memory.



### 6-3-1 CPU Bus Unit Area

The CPU Bus Unit Area contains 400 words with addresses ranging from CIO 1500 to CIO 1899. Words in the CPU Bus Unit Area are allocated to the built-in DeviceNet Section, CJ-series CPU Bus Units, and the following Expansion Units: NSJ Controller Link Unit and NSJ Ethernet Unit. These words are used to transfer data such as operating status. Each CPU Bus Unit is allocated 25 words based on its unit number, as shown in the following table.

Data is exchanged with CPU Bus Units once each cycle during I/O refreshing, which occurs after program execution. (Words in this data area cannot be refreshed with immediate-refreshing or IORF(097).)

Unit number	Allocated words
0	CIO 1500 to CIO 1524
1	CIO 1525 to CIO 1549
2	CIO 1550 to CIO 1574
3	CIO 1575 to CIO 1599
4	CIO 1600 to CIO 1624
5	CIO 1625 to CIO 1649
6	CIO 1650 to CIO 1674
7	CIO 1675 to CIO 1699
8	CIO 1700 to CIO 1724
9	CIO 1725 to CIO 1749
A	CIO 1750 to CIO 1774
B	CIO 1775 to CIO 1799
C	CIO 1800 to CIO 1824
D	CIO 1825 to CIO 1849
E	CIO 1850 to CIO 1874
F	CIO 1875 to CIO 1899

The function of the 25 words depends upon the CPU Bus Unit being used. For details, refer to the Unit's operation manual.

Words in the CPU Bus Unit Area that aren't allocated to CPU Bus Units can be used only in the program.

#### Forcing Bit Status

Bits in the CPU Bus Unit Area can be force-set and force-reset.

#### CPU Bus Unit Area Initialization

The contents of the CPU Bus Unit Area will be cleared in the following cases:

- 1,2,3...**
1. The operating mode is changed from PROGRAM to RUN or MONITOR mode or vice-versa.
  2. The NSJ Controller's power supply is cycled.
  3. The CPU Bus Unit Area is cleared from a Programming Device (i.e., the CX-Programmer).
  4. NSJ Controller operation is stopped when a fatal error other than an FALS(007) error occurs. (The contents of the CPU Bus Unit Area will be retained when FALS(007) is executed.)

#### IOM Hold Bit Operation

If the IOM Hold Bit (A50012) is ON, the contents of the CPU Bus Unit Area won't be cleared when a fatal error occurs or the operating mode is changed from PROGRAM mode to RUN/MONITOR mode or vice-versa. It will still be cleared if the power supply is cycled.

If the IOM Hold Bit (A50012) is ON and the PLC Setup's "IOM Hold Bit Status at Startup" setting is set to protect the IOM Hold Bit, the contents of the CPU Bus Unit Area won't be cleared when the NSJ Controller's power supply is cycled.

### 6-3-2 Display Section Status Area

The Display Section Status Area contains 100 words with addresses ranging from CIO 1900 to CIO 1999. Words in the Display Section Status Area are allocated to providing the status of the Display Section.

Word	Name	Contents
CIO 1900	Mode Status	Shows the operating mode of the Display Section.
CIO 1901	Screen Transfer Status	Stores the status of screen transfer for the Display Section.
CIO 1902	Error Status	Stores the error status of the Display Section. This is the error status detected by the Display Section. Any errors indicated here will not cause fatal or non-fatal errors for the Controller Section.
CIO 1903 to CIO 1999	Reserved by system.	---

#### Display Section Mode Status

Word	Bit	Settings	Description
CIO 1900	00 to 13	Reserved by system.	---
	14	ON: Display Section is in Maintenance Screen Mode. OFF: Display Section is in Normal Screen Mode.	Turns ON when the System Menu is selected by user operation. Turns OFF when the System Menu is ended.
	15	ON: Display Section is operating. OFF: Display Section is stopped.	Turns ON when initialization with the Controller Section has been completed and the Display Section enters normal operating status. Also turns ON when the Maintenance Screen Mode is entered.

#### Display Screen Transfer Status

Word	Bit	Settings	Description
CIO 1901	00 to 07	01 hex: Download in progress 02 hex: Upload in progress 03 hex: Preparing transfer 04 hex: Transfer completed 05 hex: Resetting	---
	08 to 15	Reserved by system.	---

### Display Section Error Status

Word	Bit	Settings	Description
CIO 1902	00	ON: Controller Section cyclic monitoring error OFF: Controller Section cyclic monitoring normal	Turns ON when cyclic servicing by the Controller Section is not performed for a specific period of time.
	01	ON: Routing table error OFF: Routing tables normal	Turns ON when the routing tables read from the Controller Section have an error.
	02 to 15	Reserved by system.	---

### 6-3-3 Special I/O Unit Area

The Special I/O Unit Area contains 960 words with addresses ranging from CIO 2000 to CIO 2959. Words in the Special I/O Unit Area are allocated to CJ-series Special I/O Units to transfer data such as the operating status. Each Special I/O Unit is allocated 10 words based on its unit number, as shown in the following table.

In the NSJ Controller, the Display Section uses unit number 21 for the Screen Transfer Unit. Do not use unit number 21 for any other Special I/O Unit.

Unit number	Allocated words
0	CIO 2000 to CIO 2009
1	CIO 2010 to CIO 2019
2	CIO 2020 to CIO 2029
3	CIO 2030 to CIO 2039
.	.
.	.
.	.
21: Reserved by the system.	CIO 2210 to CIO 2219
.	.
.	.
.	.
93	CIO 2930 to CIO 2939
94	CIO 2040 to CIO 2049
95	CIO 2950 to CIO 2959

### 6-3-4 DeviceNet Area

The DeviceNet Area consists of 600 words from CIO 3200 to CIO 3799. Words in the DeviceNet Area are allocated to slaves for DeviceNet remote I/O communications when fixed allocations are used for the built-in DeviceNet master.

When the master in the DeviceNet Section is used, words are allocated to slaves using fixed allocations according to fixed allocation settings 1, 2, and 3. One of these fixed areas is selected.

Area	Output Area (master to slaves)	Input Area (slaves to master)
Fixed Allocation Area 1	CIO 3200 to CIO 3263	CIO 3300 to CIO 3363
Fixed Allocation Area 2	CIO 3400 to CIO 3463	CIO 3500 to CIO 3563
Fixed Allocation Area 3	CIO 3600 to CIO 3663	CIO 3700 to CIO 3763

The following words are allocated to the DeviceNet Section when the remote I/O slave is used with fixed allocations.

Area	Output Area (master to slaves)	Input Area (slaves to master)
Fixed Allocation Area 1	CIO 3370	CIO 3270
Fixed Allocation Area 2	CIO 3570	CIO 3470
Fixed Allocation Area 3	CIO 3770	CIO 3670

Data is exchanged regularly to slaves in the network (independent of the program) through the built-in DeviceNet Section.

Bits in the DeviceNet Area can be force-set and force-reset.

**Note** There are two ways to allocated I/O in DeviceNet networks: Fixed allocations according to node addresses and user-set allocations.

- With fixed allocations, words are automatically allocated to the slaves in the specified fixed allocation area (1, 2, or 3) according to the node addresses.
- With user-set allocations, the user can allocate words to slaves from the following words.  
 CIO Area: CIO 0000 to CIO 6143  
 Work Area: W000 to W511  
 Holding Area: H000 to H511  
 DM Area: D00000 to D32767  
 EM Area: E00000 to E32767, banks 0 to C hex

For details on word allocations, refer to the *CS/CJ Series DeviceNet Operation Manual (W267)*.

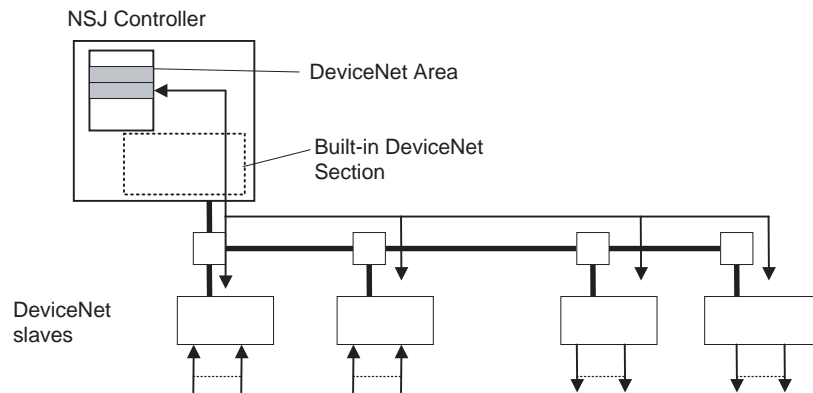

With fixed allocation, words are assigned according to node numbers. (If a slave requires two or more words, it will be allocated as many node numbers as words required.)

**DeviceNet Area Initialization**

The contents of the DeviceNet Area will be cleared in the following cases:

- 1,2,3...**
1. The operating mode is changed from PROGRAM to RUN or MONITOR mode or vice-versa.
  2. The NSJ Controller's power supply is cycled.
  3. The DeviceNet Area is cleared from a Programming Device (i.e., the CX-Programmer).
  4. NSJ Controller operation is stopped when a fatal error other than an FALS(007) error occurs. (The contents of the DeviceNet Area will be retained when FALS(007) is executed.)

**IOM Hold Bit Operation**

If the IOM Hold Bit (A50012) is ON, the contents of the DeviceNet Area will not be cleared when a fatal error occurs or the operating mode is changed from PROGRAM mode to RUN or MONITOR mode or vice-versa. It will still be cleared when the power supply is cycled.

If the IOM Hold Bit (A50012) is ON and the PLC Setup's "IOM Hold Bit Status at Startup" setting is set to protect the IOM Hold Bit, the contents of the DeviceNet Area will not be cleared when the NSJ Controller's power supply is cycled.

**6-3-5 Auxiliary Area**

The following bits and words have been added for use by the NSJ Controller.

Address		Name	Function	Settings	Status after mode change	Status at startup	Write timing	Read/write
Words	Bits							
A343	A34312	Verification Mismatch Flag	Turns ON when data mismatched for file verification.	1: Data mismatch 0: Data match	Held.	Cleared.	When a file is verified	Read-only
A355	A35500	Display Section Initializing Flag	Turns ON when power is turned ON to the NSJ Controller, power to the Display Section is interrupted, or the Display Section is restarted. Turns OFF when the Display Section has completed interface initialization with the Control Section. Ladder program execution will start even if this flag is ON. To keep the Controller Section in CPU standby status and thus prevent ladder program execution until after initialization has been completed (i.e., until this flag turns OFF), set the Startup Condition parameter in the PLC Setup.	1: NSJ Controller power has just been turned ON, power has been interrupted to the Display Section, or the Display Section has been restarted. 0: The Display Section has completed interface initialization with the Controller Section	Held.	Cleared.	When NSJ Controller power is turned ON or Display Section power is interrupted or restarted	Read-only
A395	A39500	Fatal Error Flag	Turns ON when a fatal error occurs. Operation will stop.	1: A fatal error has occurred. 0: Operation is normal	Held.	Cleared.	When a fatal error occurs	Read-only
	A39501	Non-fatal Error Flag	Turns ON when a non-fatal error occurs. Operation will not stop.	1: A non-fatal error has occurred. 0: Operation is normal	Held.	Cleared.	When a non-fatal error occurs	Read-only
A401	A40112	Display Section Fatal Error Flag	Turns ON when a fatal error occurs in the Display Section (WDT error or Inner bus error). The Controller Section will stop operating and the ERR/ALM indicator on the Controller Section will light. Note: This flag will turn OFF when the error clear operation is performed, but it will turn ON again if the cause of the error has not been removed.	1: A fatal error has occurred in the Display Section. 0: Operation is normal	Cleared.	Cleared.	When a fatal error occurs	Read-only

Address		Name	Function	Settings	Status after mode change	Status at start-up	Write timing	Read/write
Words	Bits							
A402	A40208	Display Section Non-fatal Error Flag	Turns ON when an error occurs in data exchange between the Controller Section and the Display Section (including an error in the Display Section itself). The Controller Section will not stop operating, but the ERR/ALM indicator on the Controller Section will flash. The Display Section will stop operating. Note: Further information on the error will be stored in A424. Note: This flag will turn OFF when the error clear operation is performed.	1: A non-fatal error has occurred in the Display Section. 0: Operation is normal	Cleared.	Cleared.	When a non-fatal error occurs	Read-only
A424	A42400 to A42303	Display Section Fatal Error Details	When A40112 turns ON, information on the Display Section fatal error will be stored here.	00: Reserved by system. 01: Inner Board bus error 02: Reserved by system. 03: Reserved by system.	Cleared.	Cleared.	When A40112 turns ON	Read-only
	A42404 to A42415	Display Section Non-fatal Error Details	When A40208 turns ON, information on the Display Section non-fatal error will be stored here.	04: Inner Board cannot be serviced. 05 to 15: Reserved by system.	Cleared.	Cleared.	When A40208 turns ON	Read-only
A608	A60800	Display Section Restart Bit	Turn ON this bit to restart the Display Section. This bit will be automatically turned OFF by the system when Display Section initialization has been completed.	---	Held.	Cleared.	---	Read/write

# SECTION 7

## Operation of the Controller Section

This section describes the operation of the Controller Section.

7-1	Power OFF Operation . . . . .	120
7-1-1	Power OFF Operation . . . . .	120
7-1-2	Instruction Execution for Power Interruptions . . . . .	122
7-2	Cycle Time . . . . .	124

## 7-1 Power OFF Operation

### 7-1-1 Power OFF Operation

The following processing will be performed if power to the NSJ Controller or CJ-series Expansion Racks is interrupted. The following processing will be performed if the power supply voltage drops to the power OFF detection voltage for a period of time while the Controller Section is operating in RUN or MONITOR mode.

- 1,2,3...**
1. The Controller Section and CJ-series Expansion Racks will stop.
  2. All outputs from Output Units will be turned OFF.

**Note** All outputs will turn OFF despite an I/O Memory Hold Bit or I/O Memory Hold Bit at power ON settings in the PLC Setup.

If the power supply voltage drops only momentarily, operation may stop or it may continue depending on the length of the momentary power interruption. The times required to detect a power interruption and stop operation are given in the following table.

Unit		Power OFF detection voltage	Momentary interrupt time	
			A. Operation continues.	B. Operation stops.
NSJ Controller		20.4 V DC	Less than 2 ms	2 ms or longer
AC Power Supply Unit	100 V AC	85 V AC	Less than 10 ms	25 ms or longer
	200 V AC	170 V AC		
	100 to 240 V AC (wide range)	85 V AC		
DC Power Supply Unit	CJ1W-PD025	19.2 V DC	Less than 2 ms	5 ms or longer
	CJ1W-PD022	21.6 VDC		10 ms or longer

- 1,2,3...**
1. The system will continue to run unconditionally if the momentary power interruption lasts less than the time given for *A. Operation continues*.
  2. A momentary power interruption may or may not be detected for power interruptions that lasts more than the time given for *A. Operation continues* but less than the time give for *B. Operation stops*, i.e., this is an unknown area that depends on the load on the power supply. (The NSJ Controller itself does not have an unknown area.)
  3. The system will stop unconditionally if the momentary power interruption lasts more than the time give for *B. Operation stops*.
  4. The Display Section may stop operating even for power interrupts of 2 ms or less, but operation will recover after the power supply is restored.



The power holding time for the NSJ Controller itself is too short (2 ms) and the Power OFF Detection Delay Time in the PLC Setup will not work for it.

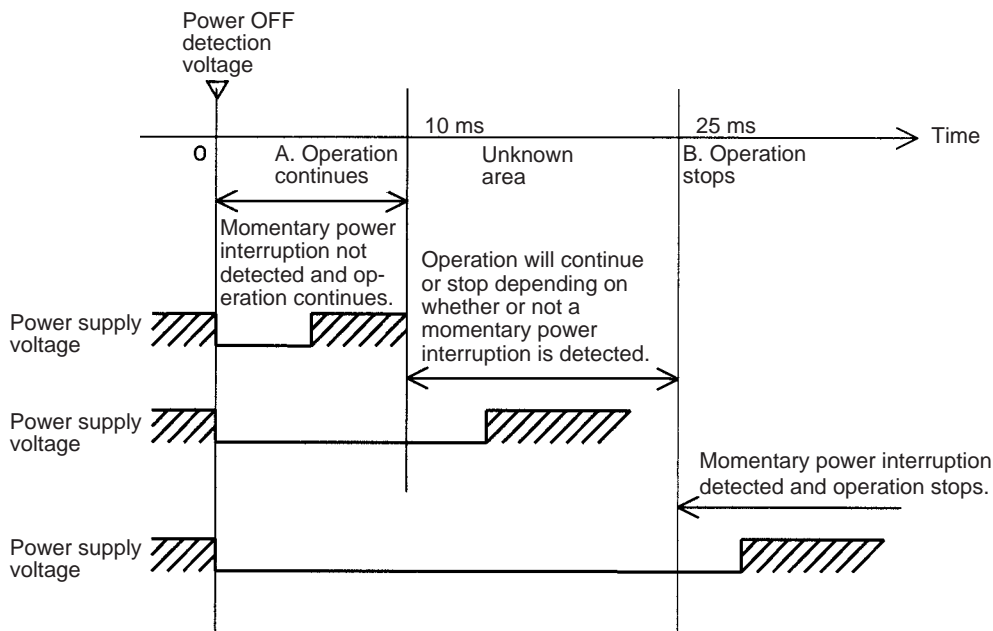

The following timing chart shows the power OFF operation in more detail.

**Power OFF Timing Chart**

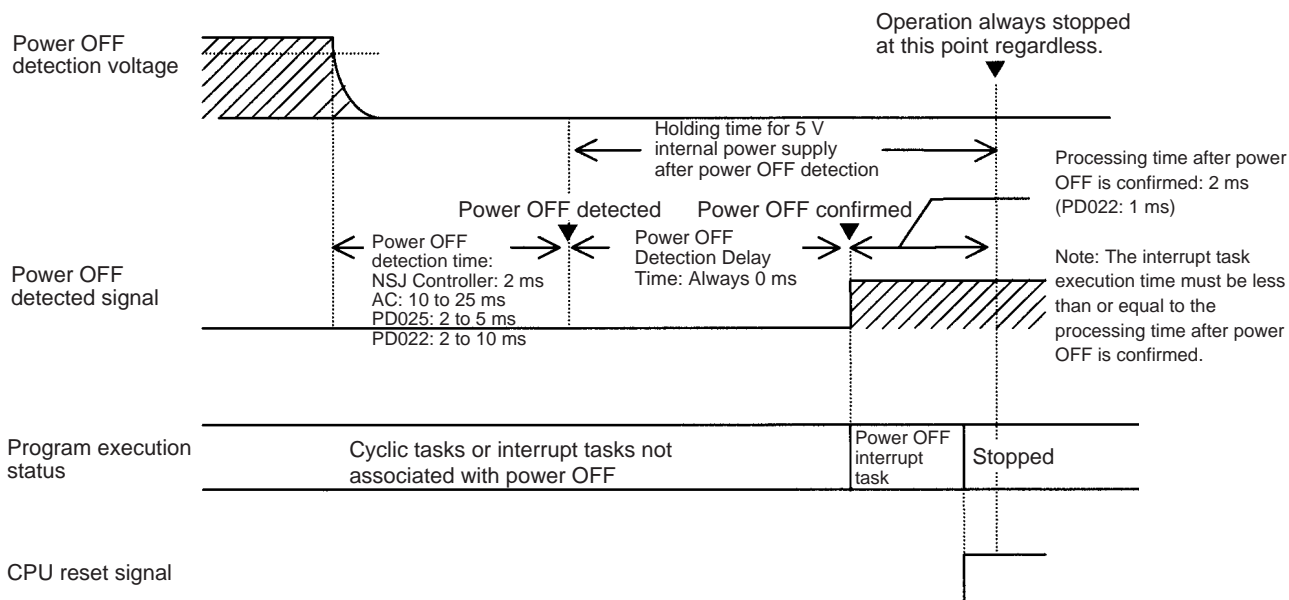

**Power OFF Detection Time**

The time it takes to detect power OFF after the power supply falls below the power OFF detection voltage.

**Power OFF Detection Delay Time**

The delay time after power OFF is detected until it is confirmed. With the NSJ Controller, the power OFF detection delay time is always 0 ms.

**Power Holding Time**

The maximum amount of time (fixed at 2 ms) that 5 V will be held internally after power shuts OFF. The time that it takes for the power OFF interrupt task to execute must not exceed 2 ms. The power OFF interrupt task will be ended even if it has not been completely executed the moment this time expires.

**Description of Operation**

Power OFF will be detected if the power supply voltage falls below the power OFF detection voltage for the power OFF detection time (2 ms for the NSJ Controller, somewhere between 10 to 25 ms for AC Power Supply Units, somewhere between 2 to 5 ms for the CJ1W-PD025 DC Power Supply Unit, and somewhere between 2 to 10 ms for the CJ1W-PD022 DC Power Supply Unit), and then the following processing will be performed.

- 1,2,3...**
1. If the power OFF interrupt task is disabled (default PLC Setup setting) The CPU reset signal will turn ON and the Controller Section will be reset immediately.
  2. If the power OFF interrupt task is enabled in the PLC Setup, the CPU reset signal will turn ON and the Controller Section will be reset after the power OFF interrupt task has been executed (see note). Make sure that the power OFF interrupt task will finish executing within 2 ms. The 5-V internal power supply will be maintained only for 2 ms after power OFF is detected.

**Note** The holding time for the internal 5-V power supply of CJ1W-PD022 Power Supply Units when a power interruption occurs is 1 ms. This means that the Power OFF Interrupt Task cannot be used.

**7-1-2 Instruction Execution for Power Interruptions**

If power is interrupted and the interruption is confirmed when the NSJ Controller is operating in RUN or MONITOR mode, the instruction currently being executed will be completed (see note 1) and the following power interruption processing will be performed.

- If the power OFF interrupt task is disabled, the Controller Section will be reset immediately.
- If the power OFF interrupt task is enabled, the task will be executed and then the Controller Section will be reset immediately.

The power OFF interrupt task is enabled and disabled in the PLC Setup.

- Note**
1. The current instruction can be completed only when the time required to complete execution is less than or equal to the processing time after power interruption detection (2 ms). If the instruction is not completed within this time, it will be interrupted and the above processing will be performed.
  2. The processing time after a power interruption is detected is 1 ms when a CJ1W-PD022 is mounted. The above processing will thus be started 1 ms after the power interruption occurs.

**Disabling Power Interruption Processing in the Program**

If the power OFF interrupt task is disabled, areas of the program can be protected from power interruptions so that the instructions will be executed before the power OFF processing is performed even if the power supply is interrupted. This is achieved by using the DISABLE INTERRUPTS (DI(693)) and ENABLE INTERRUPTS (EI(694)) instructions.

The following procedure is used.

- 1,2,3...
1. Insert DI(693) before the program section to be protected to disable interrupts and then place EI(694) after the section to enable interrupts.
  2. Set the Disable Setting for Power OFF Interrupts in A530 to A5A5 Hex to enable disabling power interruption processing.

**Note** A530 is normally cleared when power is turned OFF. To prevent this, the IOM Hold Bit (A50012) must be turned ON and the PLC Setup must be set to maintain the setting of the IOM Hold Bit at Startup, or the following type of instruction must be included at the beginning of the program to set A530 to A5A5 Hex.

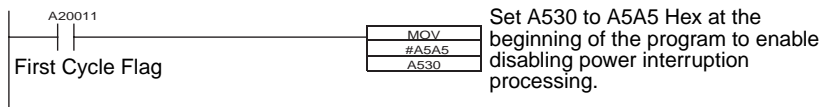

3. Disable the Power OFF Interrupt Task in the PLC Setup.

With the above procedure, all instructions between DI(693) and EI(694) (or END) will be completed (see note 1) before the Power OFF Interrupt is executed even if the power interruption occurs while executing the instructions between DI(693) and EI(694).

- Note**
1. The protected instructions can be completed only when the time required to complete execution is less than or equal to the processing time after power interruption detection (2 ms). If the instructions are not completed within this time, they will be interrupted and the Controller Section will be reset.
  2. The processing time after a power interruption is detected is 1 ms when a CJ1W-PD022 is mounted. The Controller Section will thus be reset 1 ms after the power interruption occurs.
  3. If the Power OFF Interrupt Task is not disabled in the PLC Setup, the Power OFF Interrupt Task will be executed, and the Controller Section will be reset without executing the protected instructions as soon as the power interruption is detected.
  4. If a power interrupt is detected while DI(693) is being executed, the Controller Section will be reset without executing the protected instructions.

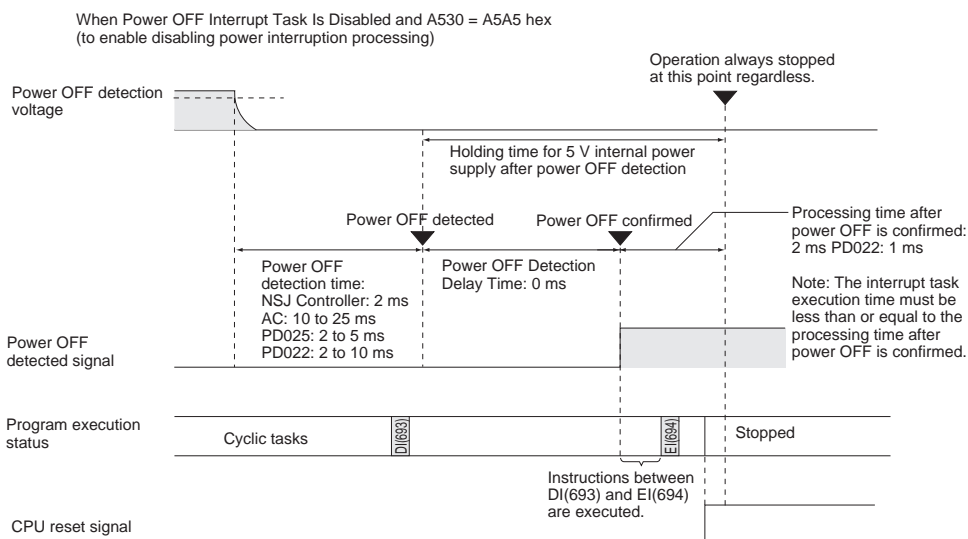

If A530 is not set to A5A5 hex, operation will be as normal, i.e., execution of the current instruction will be completed and then power interrupt processing will be performed.

Interrupt processing is performed according to the contents of A530 and the PLC Setup as shown below.

Contents of A530		A5A5 hex (disabling power interrupt processing)	Other
Power OFF Interrupt Task (PLC Setup)	Disabled	All instructions between DI(693) and EI(694) are executed and the Controller Section is reset.	Execution of the current instruction is completed and the Controller Section is reset.
	Enabled	Execution of the current instruction is completed, the Power OFF Interrupt Task is executed, and the Controller Section is reset.	

## 7-2 Cycle Time

The Controller Section of an NSJ Controller performs overhead processing, instruction execution, cycle time calculations, I/O refreshing, and peripheral processing in the same way as a CS/CJ-series CPU Unit. Refer to *10-4 Computing the Cycle Time* in the *CJ Series PLC Operation Manual (W393)* for information on calculating the cycle time.

For the NSJ Controller, however, the following times must be considered for communications between the Controller Section and Display Section on the Inner Bus and for the built-in DeviceNet master (CPU Bus Unit).

Item	Time
Extension added to cycle time for Inner Bus communications	1 ms
Extension added to cycle time for built-in DeviceNet operation	0.4 ms

The affect of DeviceNet communications also depends on the number of words being transferred. Refer to *10-4 Computing the Cycle Time* in the *CJ Series PLC Operation Manual (W393)* for information on calculating the cycle time.

# SECTION 8

## System Menu Operations

This section describes the methods for operating the System Menu.

8-1	Operating Modes and System Menu . . . . .	127
8-1-1	Mode Configuration . . . . .	127
8-1-2	System Menu Configuration . . . . .	127
8-1-3	Overview of Menu Items . . . . .	127
8-1-4	Using the System Menu . . . . .	130
8-2	Initializing and Saving Data and Removing the Memory Card . . . . .	132
8-2-1	Screen Data Area Format . . . . .	133
8-2-2	Initializing or Saving the Alarm/Event History . . . . .	134
8-2-3	Initializing and Saving Data Log . . . . .	135
8-2-4	Initializing and Saving the Operation Log . . . . .	136
8-2-5	Initializing and Saving the Error Log . . . . .	137
8-2-6	Language Selection . . . . .	139
8-2-7	Removing the Memory Card . . . . .	139
8-2-8	Initializing Internal Holding Memories (\$HB/\$HW) . . . . .	140
8-3	PT Settings . . . . .	142
8-3-1	Start-up Wait Time . . . . .	144
8-3-2	Screen Saver . . . . .	144
8-3-3	Key Press Sound . . . . .	145
8-3-4	Buzzer Sound . . . . .	145
8-3-5	Backlight . . . . .	146
8-3-6	Calendar Check . . . . .	147
8-3-7	Printer Control Method . . . . .	149
8-3-8	Printing Type . . . . .	149
8-3-9	Orientation . . . . .	150
8-3-10	Changing Values in Device Monitor Setting . . . . .	150
8-3-11	Contrast . . . . .	150
8-4	Project Settings . . . . .	150
8-4-1	Project Title . . . . .	151
8-4-2	Number of Labels . . . . .	151
8-4-3	Initial Screen . . . . .	151
8-4-4	Initial Label . . . . .	152
8-4-5	Alarm/Event History Recording Method . . . . .	152
8-4-6	Data Log Recording Method . . . . .	152
8-4-7	Operation Log Recording Method . . . . .	152
8-4-8	Error Log Recording Method . . . . .	153
8-4-9	System Memory . . . . .	153
8-5	Setting Passwords . . . . .	154
8-5-1	Changing the Password . . . . .	154
8-5-2	Setting the Password Function . . . . .	155

8-6	Communications Settings . . . . .	156
8-6-1	Communications Conditions . . . . .	156
8-6-2	Setting 1:1 NT Link . . . . .	158
8-6-3	Setting High-speed 1:N NT Links (Standard, High-speed) . . . . .	159
8-6-4	Setting Ethernet . . . . .	160
8-6-5	Setting the Controller Link Network . . . . .	161
8-6-6	Setting Bar Code Readers . . . . .	161
8-6-7	Modem Settings . . . . .	162
8-7	Screen Data Check . . . . .	163
8-8	Special Screens . . . . .	164
8-8-1	Alarm History . . . . .	165
8-8-2	Operation Log . . . . .	166
8-8-3	Error Log . . . . .	167
8-8-4	Device Monitor . . . . .	167
8-8-5	Communications Test . . . . .	169
8-8-6	USB Device List . . . . .	170
8-8-7	Display Capture Data . . . . .	171
8-8-8	Memory Card Transfers . . . . .	173
8-8-9	NSJ Troubleshooter . . . . .	173
8-8-10	Ladder Monitor (NSJ12, NSJ10, and NSJ8 Only) . . . . .	173
8-8-11	PLC Data Trace (NSJ12, NSJ10, and NSJ8 Only) . . . . .	173
8-8-12	System Version Display . . . . .	174
8-9	Hardware Check . . . . .	175
8-9-1	LCD Check . . . . .	176
8-9-2	Touch Switch Check . . . . .	176

## 8-1 Operating Modes and System Menu

The System Menu can be used to set various NSJ Controller settings by operating the touch switches on the screen. The following diagram shows the menu configuration in the System Menu. Refer to 8-1-4 *Using the System Menu* for details on System Menu operations.

### 8-1-1 Mode Configuration

The Display Section of the NSJ Controller has the following operating modes.

Mode	System Menu:	Displays the System Menu to enable setting parameters for the NSJ Controller.	
	RUN mode:	Displays screens, allows data input, and communicates with each device.	
	TRANSFER mode:	Data transfer with CX-Designer:	Uploads and downloads screen data and system programs between the CX-Designer (computer) and the NSJ Controller.
		Memory Card transfer:	Uploads and downloads screen data and system programs via the Memory Card.
	ERROR mode:	Fatal error:	Stops processing (operating) and displays error messages.
Non-fatal error:		Continues processing (operating) without displaying error message.	

### 8-1-2 System Menu Configuration

The System Menu items and functions are as follows:

System Menu	Initialize/Save:	Initializes or saves screen data, operation log, alarm/event histories, data log, and error log; initializes internal holding memories; provides a function to remove the Memory Card; and sets the system language.
	PT Settings:	Sets the system startup waiting time, screen saver, key press sound, buzzer, backlight, and clock. Also makes the settings for the printer connected to the NSJ Controller.
	Project:	Displays the project title, number of labels, history recording method, and addresses allocated to the system memory. Displays and sets the screen number displayed at startup.
	Password:	Sets and changes passwords for permitting functional object input.
	Comm:	Sets the communications conditions for serial ports A and B, a modem (screen transfer), Host Link, and Ethernet.
	Data Check:	Checks the stored screen contents without communications.
	Special Screen:	Displays the operation log, alarm history, error log, NSJ Troubleshooter, device monitor, communications test, version display, capture data, and PLC data trace results. Also executes ladder monitoring and lists devices connected to the USB port.
	Hardware Check:	Performs hardware checks, such as checking that the touch panel is operating properly.

### 8-1-3 Overview of Menu Items

The following tables show the eight menu items and provide an overview of their contents.

#### 1. Initialize Tab

Item	Function	Page
Screen Data Area	Formats project data, such as screen data.	Page 133
Alarm/Event History	Initializes the alarm/event history data that has been generated during operation or saves the alarm/event history data in the Memory Card as a CSV file	Page 134
Data Log	Initializes the data log data that registers changes to the contents of addresses, or saves the data log data in the Memory Card as a CSV file.	Page 135
Operation Log	Initializes the operation log data, such as that for functional object operations and screen switching, or saves the operation log data in the Memory Card as a CSV file.	Page 136
Error Log	Initializes the error log data that is generated by macro errors or saves the error log data in the Memory Card as a CSV file.	Page 137

Item	Function	Page
System language	The language to display system menus, input keypads, error messages, etc., can be set to Japanese or English.	Page 139
Memory Card	The Memory Card in the Display Section of the NSJ Controller (MC (DISPLAY)) can be removed.	Page 139
Internal Holding Memory (\$HB/\$HW)	Initializes the Internal Holding Bit/Word Memories.	Page 140

## 2. PT Settings Tab

Item	Function	Page
Start-up Waiting Time	Sets the system startup waiting time. Communications are not performed during this specified time when the power is turned ON or the Display Section is reset. The default is 0 s.	Page 144
Screen Saver	Sets the screen saver to ON or OFF. The default setting is OFF.	Page 144
Screen Saver Start-up Time	Sets the amount of time after which the screen saver is started. The default setting is 15 min.	Page 144
Key Press Sound	Sets whether a sound will be heard when a touch switch is pressed. The default setting is ON.	Page 145
Buzzer Sound	Sets whether a buzzer will be heard when a command from the host is received or an error occurs. The default setting is ERR ON.	Page 145
Backlight	Sets the backlight brightness to one of three levels. The brightness cannot be adjusted very much. The default setting is <i>High</i> .	Page 146
Backlight (NSJ5-SQ1/-TQ1 only)	The brightness of the backlight can be adjusted to one of three or 32 levels. The default is the highest level for 3-level adjustment. With the 32-level adjustment, the brightness can be adjusted to a lower level than the low level of 3-level adjustment.	Page 146
Calendar Check	Displays and sets the date and time for the internal clock.	Page 147
Printer Control	Sets the control method for the printer connected to the Display Section of the NSJ Controller.	Page 149
Printing Type	Sets the printing type for the printer connected to the Display Section of the NSJ Controller.	Page 149
Orientation	Sets the paper orientation for the printer connected to the Display Section of the NSJ Controller.	Page 150
Changing Value in Device Monitor Setting	Selects whether to set or just monitor device monitor values in the functions for <i>Registered Monitor</i> and <i>Switch Box</i> .	Page 150
Contrast (NSJ5-SQ0□(B)-□□□ only)	Adjusts the contrast of the screen.	Page 150

## 3. Project Tab

Item	Function	Page
Project Title	Displays the project title.	Page 151
Number of Labels	Displays the number of corresponding labels.	Page 151
Initial Screen	Sets and displays the screen numbers first displayed after the power is turned ON.	Page 151
Initial Label	Sets and displays the label number shown on the screen after the power is turned ON.	Page 152
Alarm/Event Recording Method	Displays the method for recording the alarm/event histories.	Page 152
Data Log Recording Method	Displays the method for recording the data log.	Page 152
Operation Log Recording Method	Displays the method for recording the operation log.	Page 152
Error Log Recording Method	Displays the method for recording the error log.	Page 153
System Memory (\$SB)	Displays the allocated addresses of the system bit memory (\$SB).	Page 153
System Memory (\$SW)	Displays the allocated address of the system word memory (\$SW).	Page 153



**4. Password Tab**

Item	Function	Page
Level 1	Changes the level 1 password.	Page 154
Level 2	Changes the level 2 password.	Page 154
Level 3	Changes the level 3 password.	Page 154
Level 4	Changes the level 4 password.	Page 154
Level 5	Changes the level 5 password.	Page 154
Password mode	Selects the normal password function or the password function with levels.	Page 155
Time Out	Specifies whether user authentication is automatically canceled after a set time has elapsed.	Page 155
Timeout (min)	Sets the timeout time.	Page 155
Switch Screen when canceling the authentication	Specifies whether the screen is switched automatically when authentication is canceled.	Page 155
Switch Screen No.	Sets the screen number that is displayed when authentication is canceled.	Page 155

**5. Comm Tab**

Item	Function	Page
Comms. Auto-return	Selects whether automatic recovery is used when a communications error occurs.	Page 156
Timeout interval	Sets and displays the timeout monitor time.	Page 156
Retry Counts	Sets and displays the number of communications retries.	Page 156
Serial Port A	Sets and displays whether serial port A is used, the communications method, and other details.	Page 156
Serial Port B	Sets and displays whether serial port B is used, the communications method, and other details.	Page 156
Expansion Interface	Sets and displays the connector used by serial port B (Not used for the NSJ Controller only).	Page 156
Ethernet	Sets and displays whether Ethernet is used and communications details.	Page 160
Controller Link	Sets and displays whether Controller Link is used and communications details (Not used for the NSJ Controller only).	Page 161

**6. Data Check Tab**

Item	Function	Page
Screen Number	Sets the screen number that is displayed as a sample.	Page 163
Show Address	Displays the communications addresses set in the sample display.	Page 163

**7. Special Screen Tab**

Item	Function	Page
Alarm History	Displays the alarm history screen.	Page 165
Operation Log	Displays the screen for recording the operation log.	Page 166
Error Log	Displays the screen for recording the error log.	Page 167
Special Functions	Displays the NSJ Troubleshooter, device monitor screen, and communications test screen. Also used to execute ladder monitoring, for Memory Card transfers, to display a USB device lists, to displaying capture data, and to display PLC data trace results.	Page 167
System Version	Displays the version display screen.	Page 174

**8. Hardware Check Tab**

Item	Function	Page
LCD Check	Checks the LCD.	Page 176
Touch Switch Check	Checks the touch switches.	Page 176

## 8-1-4 Using the System Menu

Information on using the menus, such as displaying the System Menu, and selecting menu items, is provided here.

**Note** The system settings set in the project data are given priority over those set in the System Menu.

### Displaying the System Menu

The System Menu can be displayed in four ways, as follows:

- 1,2,3...**
1. Press two of the four corners of the touch panel.
  2. Press a command button set to display the System Menu.
  3. Press a command button set to switch the screen to the system menu.
  4. Set \$SW0 in System Memory to 4002 BCD (FA2 hex).

#### 1. Pressing the Corners of the Touch Panel

The System Menu can be displayed by pressing two of the four corners of the Display Section's touch panel simultaneously, as shown in the following diagram.

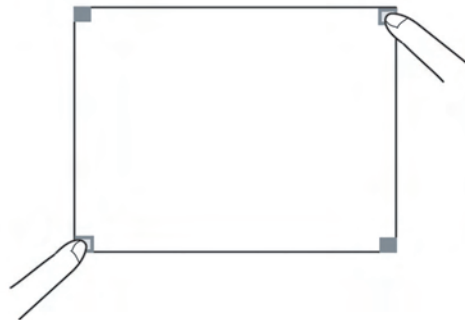

When pressing the corners of the touch panel, however, first press a corner that does not have a functional object displayed. If the position of a functional object is pressed, its function will be performed. (Even if a command button for switching screens is kept pressed after the screen has been switched, it will be detected as if the button has been released.)

The second corner pressed can be any of the other three corners. The System Menu will be displayed even if a functional object is displayed.

**2. Pressing a Command Button Set to Display the System Menu**

While creating screens, if a command button for displaying the System Menu can be created on the screen. The System Menu can be displayed by pressing this type of command button.

**3. Pressing a Command Button to Switch the Screen**

The Screen Switch command button functions include a *Indirect Specification of Screen No.* function. Store the BCD value 4002 (FA2 hex) at the communications address for indirect specification and press the command button.

Refer to *2-9 Buttons* in the *NS-Series PT Programming Manual (V073)* for information on command buttons.

**4. Storing 4002 in \$SW0 in System Memory**

A BCD value of 4002 (FA2 hex) can be stored in \$SW0 in System Memory to display the System Menu. Refer to *2-4 System Memory* in the *NS-Series PT Programming Manual (V073)* for information on the system memory.

**Selecting Menu Items**

Items in the System Menu of the NSJ Controller can be displayed by simply pressing the tab of the menu item to be displayed.

Example: Press the **Hardware Check** Tab in the System Menu to display the Hardware Check Screen.

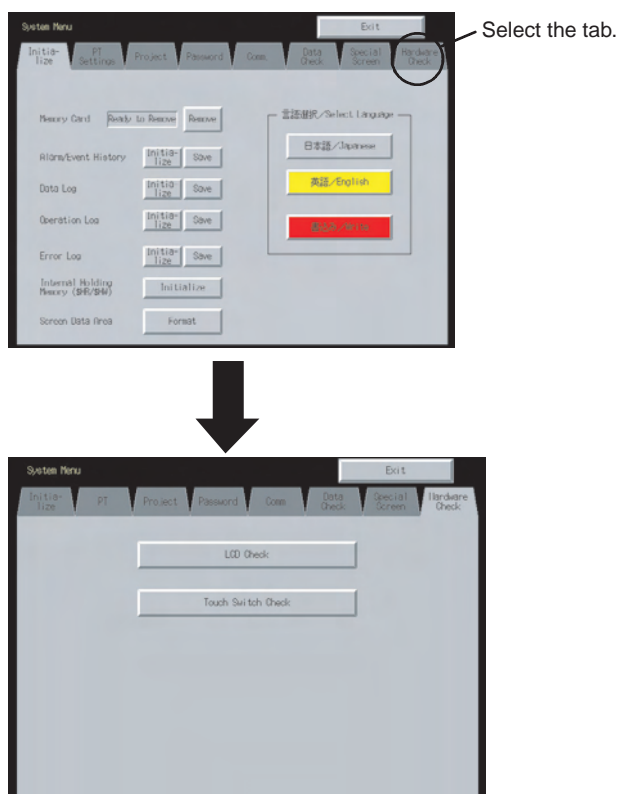

**Switching to RUN Status from the System Menu**

Press the **Exit** Button to return to RUN mode.

## 8-2 Initializing and Saving Data and Removing the Memory Card

The Initialize Tab is used to initialize or save the Display Section data and specify the system language. Used these function whenever necessary.

- Memory Card (remove)
- Alarm/event history (initialize, save)
- Data log (initialize, save)
- Operation log initialization (initialize, save)
- Error log (initialize, save)
- Internal Holding Memories (\$HB/\$HW) (initialize)
- Screen data area (format)

### NSJ12 Data Initialize Screen



### NSJ10/NSJ8 Data Initialize Screen

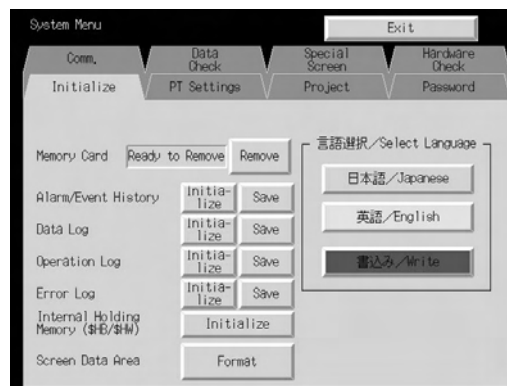

NSJ5 Data Initialize Screen

Page 1

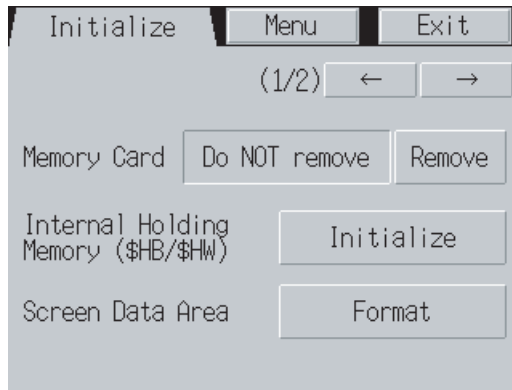

Page 2

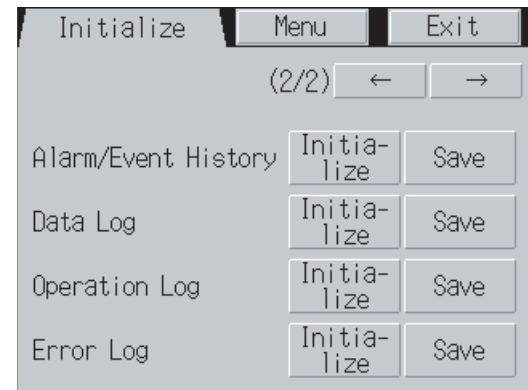

### 8-2-1 Screen Data Area Format

This function formats the NSJ Controller's screen data. Screen data must be formatted if it is corrupted and the Display Section cannot start up properly. The data recorded for the operation log, alarm history, data log, and error log is not initialized when screen data is formatted.

**Note** Before formatting screen data, check that the screen data has been backed up from the CX-Designer.

Format the screen data by using operations from the Initialize Data Tab Page in the System Menu, as follows:

- 1,2,3...
1. Press the **Screen Data Area** Button. A confirmation message will be displayed. Press the **Yes** Button to format the data. Press the **No** Button to cancel the initialize function.

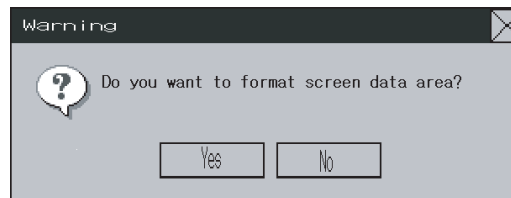

2. When the formatting screen data has been completed, a dialog box will be displayed indicating that the screen data has finished being formatted.

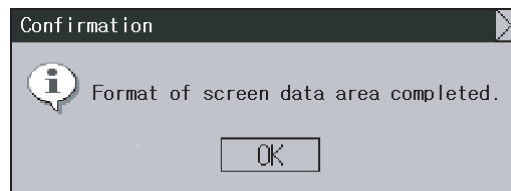

3. An error message will be displayed if the System Menu is closed while screen data is being formatted. Always transfer the screen data from the CX-Designer or Memory Card after formatting.

**Note** The Display Section of the NSJ Controller must be restarted after screen data has been transferred.

### 8-2-2 Initializing or Saving the Alarm/Event History

This function initializes or saves the alarm/event histories saved in the NSJ Controller. Use this function when screen data has been changed, for initializing history data, or for saving history data in the Memory Card as a CSV file.

While the NSJ Controller is running, the alarm/event histories continually check the status of bits registered as alarms/events and record the date, time, and number of times the bits turned ON/OFF. Up to 1,024 alarms/events can be recorded.

- Note**
- (1) The alarm/event histories can also be initialized by turning ON \$SB32 in system memory from the host.
  - (2) The alarm/event histories will be deleted when project data or system programs are downloaded.
  - (3) The alarm/event histories can also be saved by turning ON \$SB33 in system memory from the host. Refer to 2-4 System Memory in the NS-Series PT Programming Manual (V073) for details.

Initialize or save alarm/event histories by using operations from the Initialize Tab Page in the System Menu, as follows:

#### Initializing Alarm/Event Histories

- 1,2,3...**
1. Press the **Initialize** Button. A confirmation message will be displayed. Press the **Yes** Button to initialize the data. Press the **No** Button to cancel the initialize function.

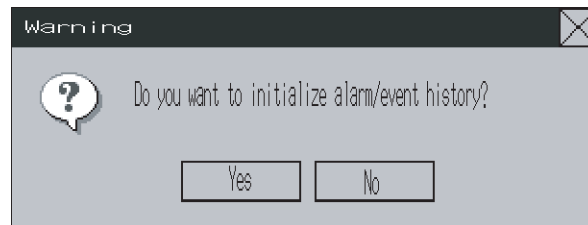

2. When the NSJ Controller has completed initializing the alarm/event histories, a dialog box will be displayed indicating that the alarm/event histories have finished being initialized.



**Saving Alarm/Event Histories**

- 1,2,3...
1. Press the **Save** Button. The Save Button will be lit yellow while data is being saved.
  2. When the NSJ Controller has completed saving the alarm/event histories, the Save Button will return to its normal color and a dialog box will be displayed indicating that the save has been finished.



**8-2-3 Initializing and Saving Data Log**

This function initializes or saves the data log saved in the NSJ Controller. Use this function to save the data log to a Memory Card as a CSV file when changing screen data or initializing log data. The data log is used to record changes over time to the contents of addresses that are registered in the log. Up to 50,000 events can be recorded.

- Note**
- (1) The data log for the specified group can be initialized by setting the group number in \$SW37 and turning ON \$SB35 in the system memory from the host. The data logs for all groups can be initialized by setting \$SW37 to 0.
  - (2) The data log will be deleted when project data or system programs are downloaded.
  - (3) The data log for the specified group can be saved by setting the group number in \$SW37 and turning ON \$SB36 in the system memory from the host. The data logs for all groups can be saved by setting \$SW37 to 0.

Initialize or save the data log by using operations from the Initialize Tab Page in the System Menu, as follows:

**Initializing the Data Log**

- 1,2,3...
1. Press the **Initialize** Button. A confirmation message will be displayed. Press the **Yes** Button to initialize the data. Press the **No** Button to cancel the initialize function.

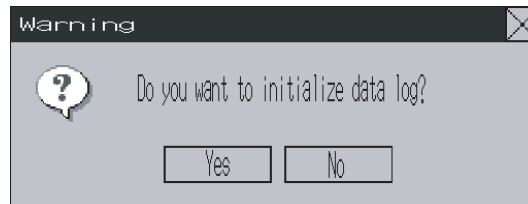

2. When the NSJ Controller has completed initializing the data log, a dialog box will be displayed indicating that the data log has finished being initialized.

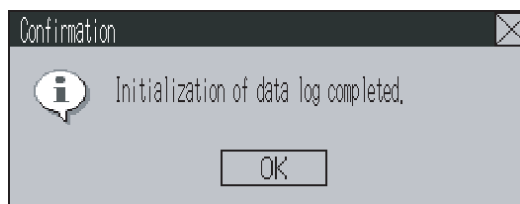

**Saving the Data Log**

- 1,2,3... 1. Press the **Save** Button. The Save Button will be lit yellow while data is being saved.
2. When the Display Section has completed saving the data log, the Save Button will return to its normal color and a dialog box will be displayed indicating that the save has been finished.

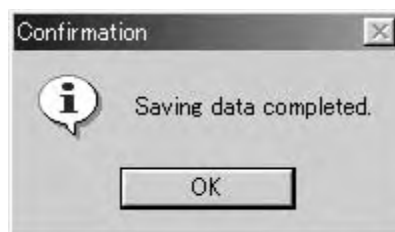

**8-2-4 Initializing and Saving the Operation Log**

This function initializes or saves the operation log saved in the NSJ Controller. Up to 1,024 operations can be recorded in order of occurrence.

Use this function to save log data as a CSV file in the Memory Card when changing screen data or initializing log data.

The operation log is used to record the number of times the following operations are performed and the order in which they occur.

- Functional object operation history
- Screen display history
- Macro execution history

Refer to 2-4 System Memory in the NS-Series PT Programming Manual (V073) for details.

- Note**
- (1) The functional objects that can be recorded are ON/OFF buttons, word buttons, Numeral Display & Input, String Display & Input, thumbwheel switches, and data block tables.
  - (2) The operation log data can also be initialized by setting the system bit memory address \$SB37 to ON from the host.
  - (3) The operation log will be deleted when project data or system programs are downloaded.
  - (4) The operation log can also be saved by turning ON \$SB38 in system memory from the host. Refer to 2-4 System Memory in the NS-Series PT Programming Manual (V073) for details.

Initialize or save the operation log by using operations from the Initialize Tab Page in the System Menu, as follows:



**Initializing the Operation Log**

- 1,2,3... 1. Press the **Initialize** Button. A confirmation message will be displayed. Press the **Yes** Button to initialize the data. Press the **No** Button to cancel the initialize function.

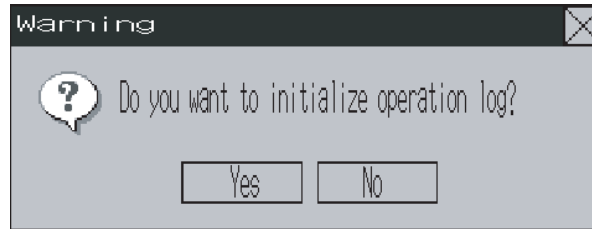

2. When the Display Section has completed initializing the operation log, a dialog box will be displayed indicating that the operation log has finished being initialized.

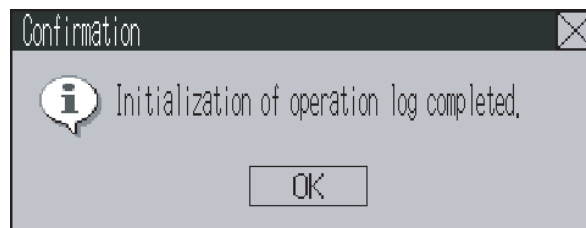

**Saving the Operation Log**

- 1,2,3... 1. Press the **Save** Button. The Save Button will be lit yellow while data is being saved.  
 2. When the Display Section has completed saving the operation log, the Save Button will return to its normal color and a dialog box will be displayed indicating that the save has been finished.

**Note** When saving the operation log, the operation log must be controlled from the system memory. For details on controlling the operation log, refer to 2-4 System Memory in the NS-Series PT Programming Manual (V073).

**8-2-5 Initializing and Saving the Error Log**

This function initializes the macro error history saved in the NSJ Controller or saves the history in the Memory Card.

Up to 100 errors can be recorded in the error log. The number of errors that can be recorded, however, also depends on the free space in the memory.

The error log records the errors that occur when the macro function is executed. Initialize or save the error history by using operations from the Initialize Tab Page in the System Menu, as follows:

**Initializing the Error Log**

- 1,2,3... 1. Press the **Initialize** Button. A confirmation message will be displayed. Press the **Yes** Button to initialize the data. Press the **No** Button to cancel the initialize function.

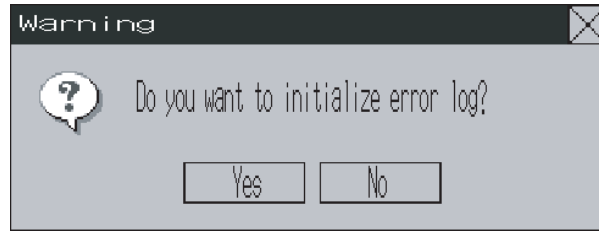

2. When the Display Section has completed initializing the error log, a dialog box will be displayed indicating that the error log has finished being initialized.

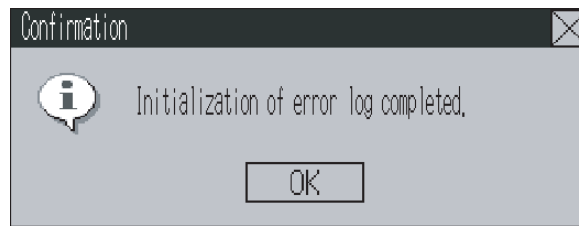

**Saving the Error Log**

- 1,2,3... 1. Press the **Save** Button. The Save Button will be lit yellow while data is being saved.
2. When the NSJ Controller has completed saving the error log, the Save Button will return to its normal color and a dialog box will be displayed indicating that the save has been finished.
- (1) The error log is deleted when project data or system programs are downloaded.
  - (2) The error log can also be initialized by turning ON \$SB42 in system memory from the host, and can be saved by turning ON \$SB43 in system memory from the host. Refer to 2-4 System Memory in the NS-Series PT Programming Manual (V073) for details.

### 8-2-6 Language Selection

The system language can be set to either Japanese or English. The system language will be used on the system menu, input keypads, message dialog boxes, etc., on the NSJ Controller.

The system language is set from the **Initialize** Tab Page in the System Menu Window using the following procedure.

- 1,2,3... 1. Select either Japanese or English in the Select Language Area.



2. After specifying the language, press the **Write** Button. The system language will be switched after the new setting has been saved.

**Note** If ASCII is set as the character display format for String Display & Input, list displays, or data block tables (character fields), the following character codes will be used depending on the system language that is set.

System language	Character display	Example (character code B5)
Japanese	Shift-JIS code	†
English	Latin 1 code	μ

The above codes will also be used when indirect specifications are made for label strings for label objects.

### 8-2-7 Removing the Memory Card

The Memory Card can be removed from the Display Section while the Display Section is ON. Use the following procedure from the Initialize Tab Page of the System Menu to remove the Memory Card.

- 1,2,3... 1. Press the **Remove** Button next to *Memory Card*.

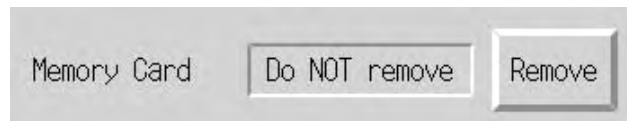

- The following dialog box will be displayed when it is safe to remove the Memory Card. Press the **OK** Button.



- Confirm that it is safe to remove the Memory Card, and remove it from the Display Section of the NSJ Controller (MC (DISPLAY)).

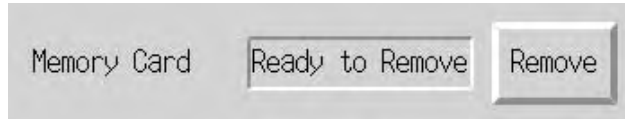

The above procedure can be used to remove the Memory Card from the Display Section. To remove the Memory Card from the Controller Section, press the MCPWR Button.

- Note**
- (1) When the Memory Card is removed, reinsert the Memory Card into the Display Section of the NSJ Controller to use it again. Once a Memory Card is removed, it must be reinserted before the NSJ Controller can access it.
  - (2) The Memory Card in the Display Section can be removed if the system memory bit \$SB50 turns ON (indicating that the Memory Card is ready to be removed) after the Host turns ON system memory bit \$SB49. Refer to *2-4 System Memory* in the *NS-Series PT Programming Manual (V073)* for details.

### 8-2-8 Initializing Internal Holding Memories (\$HB/\$HW)

The following procedure is used to initialize the Internal Holding Memories in the NSJ Controller (\$HB0 to \$HB8191 and \$HW0 to \$HW8191). Use the following procedure from the Initialize Tab Page of the System Menu to initialize the Internal Holding Memories.

- 1,2,3...** Press the Initialize Button for the Internal Holding Memories (\$HB/\$HW). The following confirmation message will be displayed. Press the **Yes** Button to initialize.

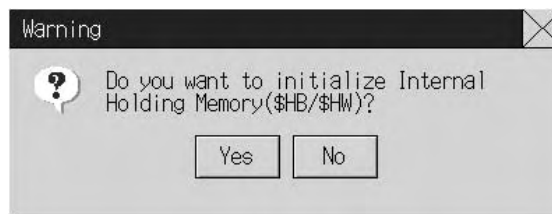

2. When Internal Holding Memory (\$HB/\$HW) initialization has been completed, the following dialog box will be displayed. Press the **OK** Button.



**Note** The NSJ Controller's internal holding memory (\$HB/\$HW) can be initialized by turning ON the system memory bit \$SB34 from the host. Refer to 2-4 System Memory in the *NS-Series PT Programming Manual (V073)* for details.

### 8-3 PT Settings

The PT Settings Tab Page is used to set the following functions.

- Start-up wait time
- Screen saver
- Key press sound
- Buzzer sound
- Backlight
- Printer control
- Printer type
- Orientation
- Calendar check
- Device monitor changing value
- Contrast (NSJ5-SQ0□(B)-□□□ only)

#### PT Settings Tab Pages for NSJ12

Page 1

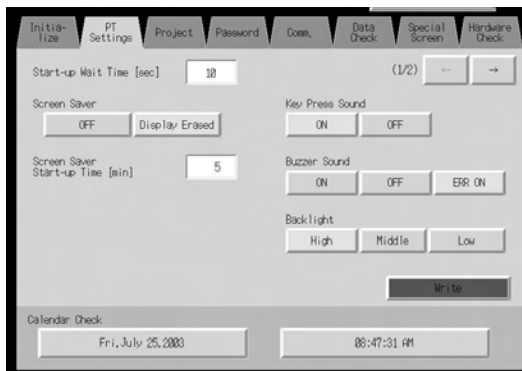

Page 2

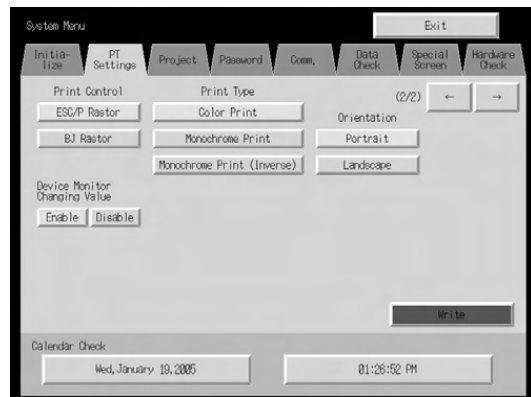

#### PT Settings Tab Pages for NSJ10 and NSJ8

Page 1

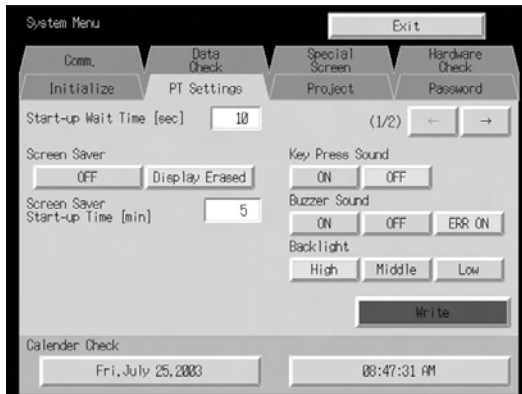

Page 2

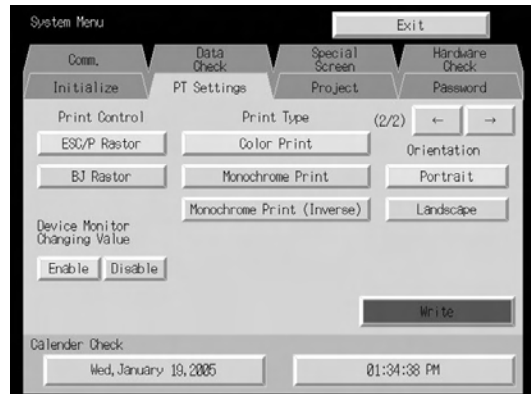

**PT Settings Tab**  
**Pages for NSJ5**

Page 1

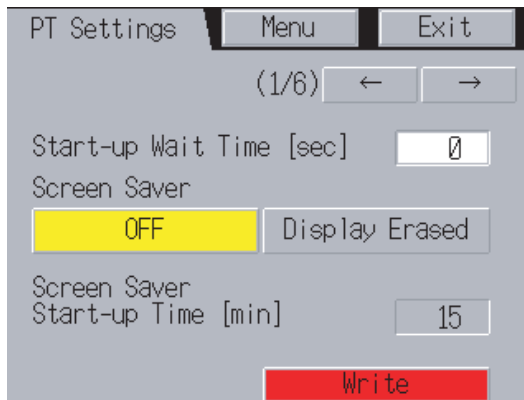

Page 2 Showing 3-Level Backlight Brightness Settings

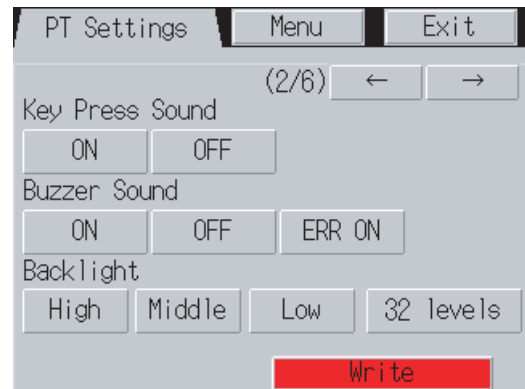

Page 2 Showing 32-Level Backlight Brightness Settings

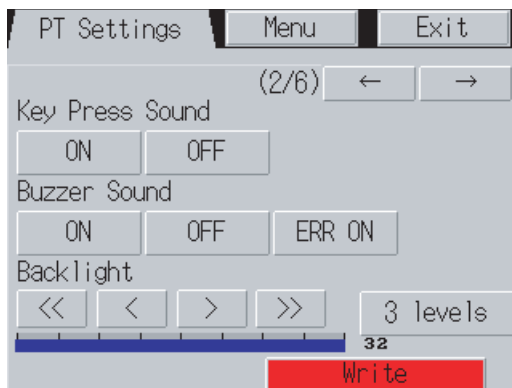

Page 3

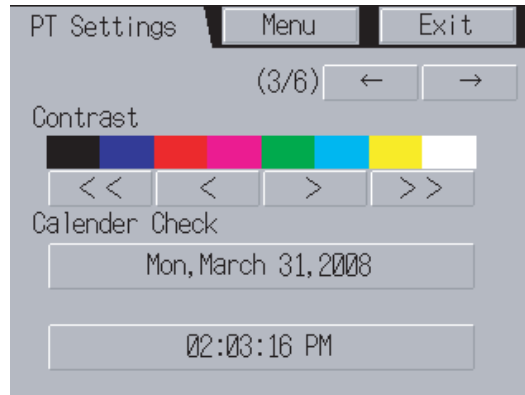

Page 4

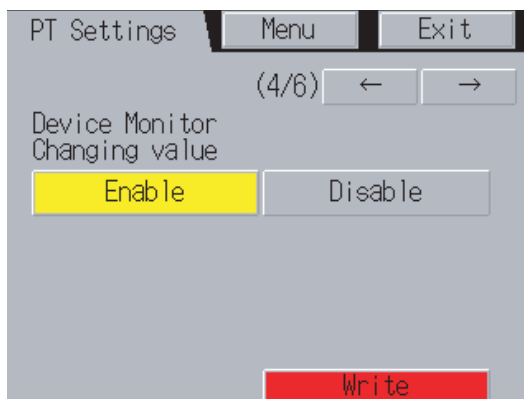

Page 5

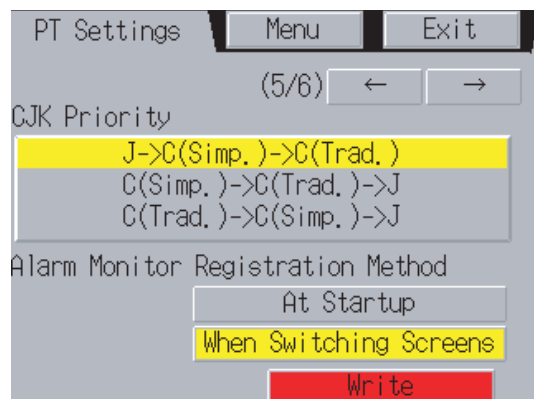

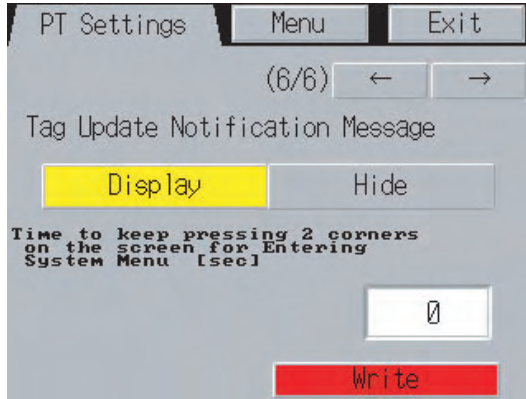

### 8-3-1 Start-up Wait Time

The start-up wait time refers to the waiting time before the Display Section of the NSJ Controller starts communicating with the host after the Display Section's power is turned ON or the Display Section is reset. Set the system start-up waiting time when the host requires time before it starts running.

The setting range is between 0 and 10 s and the default is 0 s.

Set the system start-up waiting time by using operations from the PT Tab Page in the System Menu, as follows:

- 1,2,3...**
1. Set the waiting time in the Start-up Wait Time field in seconds. Input the value in the dialog box that is displayed when the setting input field is pressed.

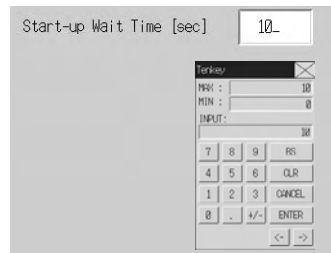

2. After setting, press the **Write** Button to save the setting.

- Note**
- (1) Nothing is displayed during the system start-up waiting time.
  - (2) The system startup waiting time is calculated from when initialization finishes. Therefore, even if the startup waiting time is set to 0 s, the Display Section will not start actual communications with the host immediately after the power is turned ON.

### 8-3-2 Screen Saver

To extend the life of the backlight, the screen saver function turns OFF the screen display when operations are not performed for a fixed period of time.

The default setting is for no screen saver.

The time before the screen saver function is activated can be set in minutes between 1 and 255 minutes. The default setting is 15 min.

Set the screen saver operation by using operations from the PT Tab Page in the System Menu, as follows:

- 1,2,3...**
1. Select either **OFF** or **Display Erased** for the screen saver.



- If **Display Erased** is selected, set the screen saver startup time. Input the value in the dialog box that is displayed when the setting input field is pressed.



- After setting, press the **Write** Button to save the setting.

**Note** Pressing any part of the touch panel will cancel the screen saver and display the previously displayed screen. When canceling the screen saver, if the part of the touch panel corresponds to the input for a functional object, the screen saver will be cancelled only. The input for the functional object will not be processed.

### 8-3-3 Key Press Sound

This function sets whether an input sound is heard when the touch switches that execute input functions for the NSJ Controller are pressed.

**ON:** Input sound is heard when the touch switches that execute input functions for the Display Section are pressed.

**OFF:** Input sound is not heard when the touch switches that execute input functions for the Display Section are pressed.

The default setting is ON.

- 1,2,3... Select either **ON** or **OFF** for the touch switch input sound.



- After setting, press the **Write** Button to save the setting.

### 8-3-4 Buzzer Sound

The buzzer is used at times such as when a command from the host is received or an error occurs. This function is set to ON or OFF in the System Menu.

**ON:** Buzzer turns ON when a command is received from the host or an error occurs.

**OFF:** Buzzer is OFF.

**ERR ON:** Buzzer turns ON only when an error occurs.

The default setting is ERR ON.

- Note**
- (1) Other commands and settings associated with the buzzer exist, but the settings here have the highest priority.
  - (2) When the buzzer is set to ON or ERR ON, the buzzer will be heard when messages are displayed with a cross (X) or exclamation mark (!) icon.
  - (3) Refer to 2-18 *Special Functions* in the *NS-Series PT Programming Manual* (V073) for details on the buzzer function.

Set the buzzer to ON/OFF by using operations from the PT Tab Page in the System Menu, as follows:

- 1,2,3... 1. Select either **ON**, **OFF**, or **ERR ON** for the buzzer setting.



2. After setting, press the **Write** Button to save the setting.

### 8-3-5 Backlight

This function sets the backlight brightness to one of three levels. The default setting is high.

Set the brightness of the backlight by using operations from the PT Tab Page in the System Menu, as follows:

- 1,2,3... 1. Select one of the three backlight brightness levels to set to high, middle, or low.



2. After setting, press the **Write** Button to save the setting.

#### NSJ5 Backlight Brightness (for the NSJ5-TQ1/-SQ1 with Lot Number 15Z0 or Later)

This function sets the backlight brightness. The brightness can be set to any of three levels or any of 32 levels. The default setting is high.

Set the brightness of the backlight by using operations from the PT Tab Settings Page in the System Menu, as follows:



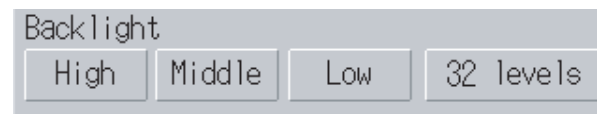

- 1,2,3... 1. Select one of the three backlight brightness levels to set to high, middle, or low, or select setting one of 32 levels.



2. After setting, press the **Write** Button to save the setting.  
3. The following screen will be displayed for 32-level adjustment.



#### Functions of Brightness Setting Buttons

	Reduces the brightness by 5 levels.		Increases the brightness by 5 levels.
	Reduces the brightness by 1 level.		Increases the brightness by 1 level.

4. The backlight brightness will change when any of the brightness setting buttons is pressed. If the Write Button is not pressed for 30 seconds after completing the setting and no other operation is performed, the backlight brightness will return to the original level, and the PT settings, including the backlight brightness, will not be written.  
5. After setting, press the **Write** Button within 30 seconds to save the setting.

- Note** If the brightness of the backlight on the NSJ5-SQ1/-TQ1 is reduced, the display and RUN indicator may be very dark. Do not reduce the brightness of the backlight so far that the display and RUN indicator cannot be seen.

### 8-3-6 Calendar Check

This function displays the time and date of the internal system clock in the Display Section.

The factory settings for the date and time are not correct.

When the time and date are set, the time and date in the Controller Section are also changed.

Set and display the date and time by using operations from the PT Tab Page in the System Menu, as follows:

- 1,2,3... 1. Press any two of the four corners of the touch panel. The System Menu will be displayed.



2. Press the **PT** Tab to display the PT Tab Page. For the NSJ5, press the Left or Right Arrow Key to switch to page 3/4 to display the time and date settings.

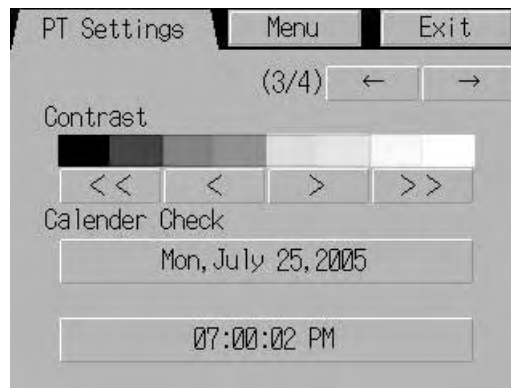

- To change the date, set the date using the tenkey that is displayed when the date field is pressed. Use the following input format to set the date: yyyy.mm.dd (yyyy: year, mm: month, dd: day), and then press the **Enter** Button to enable the settings.



- A confirmation message will be display for changing the date. Press the **OK** Button. The dates in the Controller Section and Display section will be changed.
- To change the time, set the time using the tenkey that is displayed when the time field is pressed. Use the following input format to set the time: hh.mm.ss (hh: hour, mm: minutes, ss: seconds), and then press the **Enter** Button to enable the settings.



- A confirmation message will be display for changing the time. Press the **OK** Button. The times in the Controller Section and Display Section will be changed.
- After completing the settings, press the **Exit** Button in the PT Tab Page or System Menu.

### 8-3-7 Printer Control Method

If there is a printer connected to the Display Section, select the printer's control method.

Setting item	Details
ESC/P Raster	Sets the printer's control method to ESC/P Raster. Use this setting mainly when using Epson printers.
BJ Raster	Sets the printer's control method to BJ Raster. Use this setting mainly when using Canon printers.

- 1,2,3... 1. Select either **ESC/P Raster** or **BJ Raster** in **Print Control**.

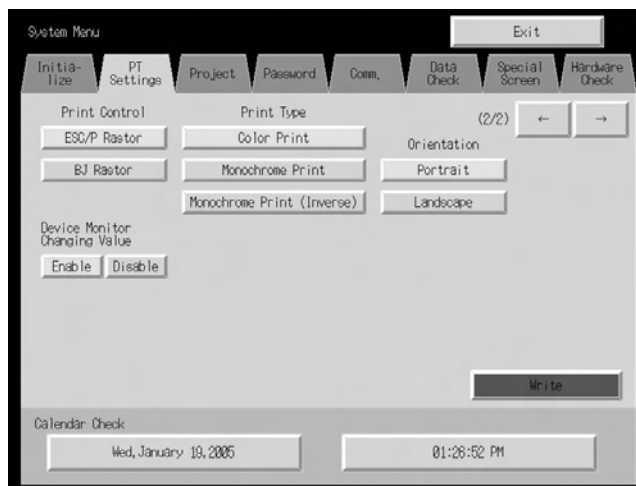

2. After setting, press the **Write** Button to save the setting.

### 8-3-8 Printing Type

If there is a printer connected to the Display Section, select the printing type.

Setting item	Details
Color Print	Prints in color.
Monochrome Print	Prints in monochrome.
Monochrome Print (Inverse)	Prints in inverted monochrome.

- 1,2,3... 1. Select **Color Print**, **Monochrome Print**, or **Monochrome Print (Inverse)** in **Print Type**.

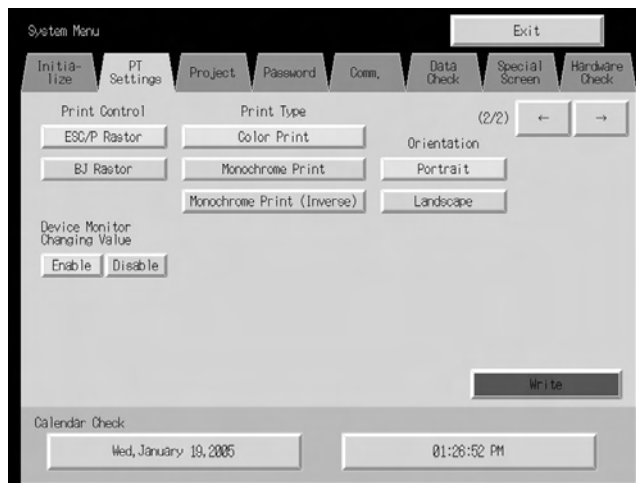

2. After setting, press the **Write** Button to save the setting.

### 8-3-9 Orientation

Select the printer paper orientation when a printer is connected to the Display Section.

- 1,2,3...
1. Select either **Portrait** or **Landscape** in **Orientation**.  
Portrait: Prints with the longer page measurement as the height (factory default).  
Landscape: Prints with the shorter page measurement as the height.
  2. After setting, press the **Write** Button to save the setting.

### 8-3-10 Changing Values in Device Monitor Setting

This setting enables using the registered monitor and switch box functions of the device monitor only for monitoring by prohibiting address changes while monitoring.

Enable Button: Enables changing monitor values (factory default)

Disable Button: Prohibits changing monitor values

This setting can also be made with the CX-Designer on the PT Tab Page of the System Settings.

### 8-3-11 Contrast

This function is supported by the NSJ5-SQ0□(B)-□□□ only.

This function adjusts the screen contrast. Contrast can be adjusted in 100 degrees.

Adjust the contrast by using operations from the PT Tab Page in the System Menu, as follows:

- 1,2,3...
1. Change the contrast setting using the left and right arrow buttons (<<, <, >, >>) for contrast adjustment. The contrast will change as soon as the buttons are pressed.

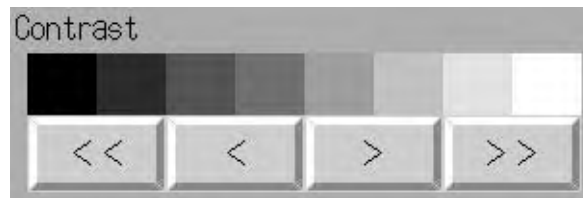

<< Button: Decreases the contrast by ten degrees.

< Button: Decreases the contrast by one degree.

> Button: Increases the contrast by one degree.

>> Button: Increases the contrast by ten degrees.

Check the contrast from the sample display of eight shades above the arrow buttons.

**Note** The contrast cannot be adjusted on NSJ5-SQ□□-□□□ Controllers with lot number 2110 (January 21, 2010) or later. (The contrast is adjusted to the optimum value in advance.)

Refer to *NSJ-series Controller Lot Numbers* on page 221 for information on lot numbers.

## 8-4 Project Settings

The Project Tab Page is used to display and set the following functions.

- Project title

- Number of labels
- Initial screen
- Initial label
- Alarm/event history recording method:  
Method for recording log of generated and deleted alarms/events.
- Data log recording method:  
Method for recording log of changes to addresses.
- Operation log recording method:  
Method for recording log of functional object operations, screen switching, and macro executions.
- Error log recording method:  
Method for recording log of macro execution errors.
- System memory:  
The addresses allocated in system memory will be displayed.

The screenshot shows a 'System Menu' window with several tabs: 'Initial-ize', 'PT Settings', 'Project', 'Password', 'Comm.', 'Data Check', 'Special Screen', and 'Hardware Check'. The 'Project' tab is active. The settings displayed are:

Project Title	Test project	
No. of Labels	5	
Initial Screen	1	Initial Label 2
Alarm/Event Rec. Method	No Ring Buffer	
Data Log Rec. Method	Use Ring Buffer (fixed)	
Oper. Log Rec. Method	No Ring Buffer	
Error Log Rec. Method	Use Ring Buffer (fixed)	
System Memory (\$SB)	Allocation host: HOST 1	Allocation address: C10 00100
System Memory (\$SW)	Allocation host: HOST 1	Allocation address: DM 00100

Buttons for 'Exit', 'Write', and 'Initial Label' are visible.

### 8-4-1 Project Title

This function displays the title of the project registered in the Display Section. The title is read-only and cannot be edited.

### 8-4-2 Number of Labels

Multiple label data can be created in each project. This function displays the number of label sets for the project registered in the Display Section. The number of labels is read-only and cannot be edited.

- Note**
- (1) Refer to 3-9 *Project Properties* in the *CX-Designer Operation Manual (V099)* for information on setting multiple labels for a project.
  - (2) Refer to *Labels* under 2-8 *Common Functional Object Functions* in the *NS-Series PT Programming Manual (V073)* for information on how to set multiple labels for a functional object.

### 8-4-3 Initial Screen

This function displays and sets the screen number of the screen that is first displayed when the Display Section is started.

Display and set the initial screen number by using operations from the Project Tab Page in the System Menu, as follows:

- 1,2,3...**
1. The number of the screen that is displayed when the Display Section is started is displayed in the initial screen field.
  2. To change the initial screen number, input the value using the tenkey, which is displayed when the display area is pressed.
  3. After setting, press the **Write** Button to save the setting.

**Note** The initial screen number can also be set from the CX-Designer.

#### 8-4-4 Initial Label

This function displays and sets the label number that is shown on the screen when the Display Section is started.

**Note** This initial label number can also be set from the CX-Designer.

#### 8-4-5 Alarm/Event History Recording Method

This function displays the method for recording the alarm/event histories. The alarm/event history recording method is read-only and cannot be edited.

This alarm/event history recording method is set from the CX-Designer.

If a ring buffer is used, when the specified number of records is exceeded, the oldest data is deleted and the new data is recorded.

If the ring buffer is not used, the Display Section stops collecting history data when the specified number of records has been reached. Initialize the alarm/event histories to reopen the history records.

**Note** Refer to *8-2-2 Initializing or Saving the Alarm/Event History* for details on initializing the alarm/event histories.

#### 8-4-6 Data Log Recording Method

This function displays the data log recording method.

The data log recording method is read-only and cannot be edited.

The use of a ring buffer for the data log recording method is fixed.

When the specified number of log entries is exceeded, the oldest data is deleted and the new data is recorded.

The number of entries in the error log is set using the CX-Designer.

**Note** Refer to *8-2-3 Initializing and Saving Data Log* in this manual and *Data Log Function* under *2-18 Special Functions* in the *NS-Series PT Programming Manual (V073)* for details on the data log.

#### 8-4-7 Operation Log Recording Method

This function displays the method for recording the operation log. The operation log recording method is read-only and cannot be edited. This operation log recording method is set from the CX-Designer.

If *Save in Ring Buffer Format* is set, when the specified number of items is exceeded, the oldest data is deleted and the new data is recorded.

If the log is not saved in ring buffer format, the Display Section stops collecting log data when the specified number of items has been reached. Initialize the operation log to reopen the record.



**Note** Refer to *8-2-4 Initializing and Saving the Operation Log* in this manual and *Operation Log Function* under *2-18 Special Functions* in the *NS-Series PT Programming Manual (V073)* for details on the operation log.

### 8-4-8 Error Log Recording Method

This function displays the error log recording method. The error log recording method is read-only and cannot be edited. The use of a ring buffer for the error log recording method is fixed.

When the maximum number of items is exceeded, the oldest data is deleted and the new data is recorded.

**Note** Refer to *8-2-5 Initializing and Saving the Error Log* in this manual and *Error Log Function* in *2-18 Special Functions* in the *NS-Series PT Programming Manual (V073)* for details on the error log.

### 8-4-9 System Memory

The system memory is used to control the Display Section and exchange information between the host and the Display Section, such as notifying the host of Display Section status. The system memory can be allocated to host addresses or to Display Section memory.

Allocating the system memory as host addresses allows operations such as controlling the Display Section from the host. The allocated location in the host is displayed in the System Memory and cannot be edited.

The locations where the system bit memory and system word memory are allocated (allocated host and address) are displayed for the *System Bit Memory (\$SB)* and *System Word Memory (\$SW)*.

**Note** Refer to *2-4 System Memory* in the *NS-Series PT Programming Manual (V073)* for details on the system memory.

## 8-5 Setting Passwords

The Display Section's password function is divided into the following two functions.

- Password Function  
Requires a password input before allowing operations on a password-protected functional object.
- Password with Levels Function  
Requires a password for authentication when performing operations on a password-protected functional object for the first time. Once authentication has been completed, operations can be performed on all functional objects of the same or lower password levels. Operations cannot be performed on functional objects protected with higher-level passwords.

The passwords are set from the CX-Designer and up to five passwords (5 levels) can be set for a single project. The passwords can be changed from the System Menu.

### 8-5-1 Changing the Password

Perform the following procedure from the System Menu to change the password.

- 1,2,3... 1. Select the **Password** Tab.

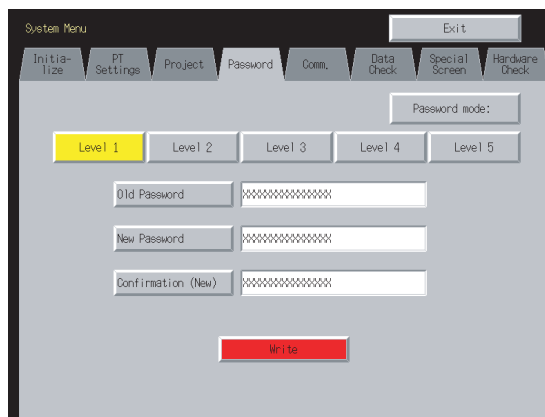

2. Select the password to be changed using the **Level 1** to **Level 5** Buttons.
3. Input the old password and new password in the corresponding fields, and then input the new password again in the confirmation field. Input the password using the virtual keyboard (text input dialog box) that is displayed by pressing the input column.



4. After changing the password, press the **Write** Button to save the setting. Save separately for each password level that is changed.

**Note** When changing passwords, do not reset the PT or turn OFF the power until the write operation has been completed (i.e., the **Write** Button has returned to the status before being pressed). If the password is not saved properly, the screen may malfunction.

If the password is forgotten, it cannot be checked from the PT. Check the password using the CX-Designer.

### 8-5-2 Setting the Password Function

Perform the following procedure from the System Menu to set a password.

- 1,2,3... 1. Select the **Password** Tab.

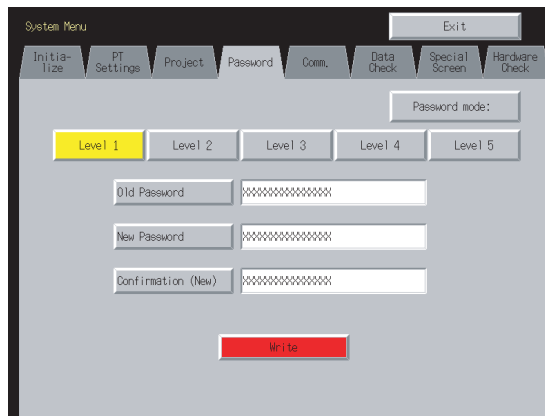

2. Press the **Password mode** Button.

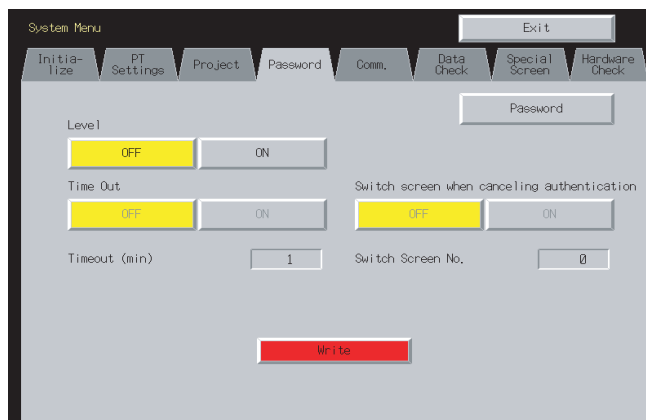

3. After making the required settings, press the **Write** Button to save the settings.

#### Settings for the Password Function

The following table describes the password function's setting items.

Setting item	Function
Level	Press the <b>OFF</b> (password) or <b>ON</b> (password with levels) Button to select the function.
OFF	Requires a password input before allowing operations on a password-protected functional object.
ON	Requires a password input for level authentication. During a session from authentication to cancellation, the user only can perform operations on functional objects that are allowed for the password level that was input at the start of the session. The user cannot perform operations on functional objects at higher levels.
Time Out	Click the <b>ON</b> or <b>OFF</b> Button to specify whether authentication is automatically canceled (timed out) after a set time has elapsed. This option can be set when the password with levels function has been turned ON.
ON	A user is automatically timed out if there are no functional object operations within the timeout time.
OFF	Authentication is not automatically canceled. To cancel authentication, press a command button set for cancellation.

Setting item	Function
Timeout (min)	When the <i>Time Out</i> Option is set to ON, this setting specifies the timeout time in minutes (1 to 60 minutes).
Switch Screen when canceling the authentication	Click the <b>ON</b> or <b>OFF</b> Button to specify whether the screen is automatically switched to a specified screen when a user logs out. This option can be set when the password with levels function has been turned ON.
ON	The screen is switched to the specified Switch Screen No. when authentication is canceled.
OFF	The screen is not switched when authentication is canceled.
Switch Screen No.	If switching the screen when authentication is canceled has been turned ON, the screen is changed to the screen number set here when authentication is canceled.

- Note**
- (1) The password settings can also be made from the CX-Designer.
  - (2) When changing passwords, do not reset the PT or turn OFF the power until the write operation has been completed (i.e., the **Write** Button has returned to the status before being pressed). If the password is not saved properly, the screen may malfunction.
  - (3) If the password is forgotten, it cannot be checked from the PT. Check the password using the CX-Designer.

## 8-6 Communications Settings

The methods for setting the communications conditions with the host are described here.



### 8-6-1 Communications Conditions

Set the communications conditions by using operations from the Comm Tab Page in the System Menu, as follows: Input the communications conditions, and then press the **Write** Button to save the settings.

Changed settings are enabled after the Display Section is restarted.

#### Communications Conditions Setting Items

The setting items for the communications conditions between the Display Section and host are as follows:

##### Communications Auto-return

Select whether or not to use communications auto-return using the **ON** and **OFF** Buttons.

- ON: The Display Section will automatically return to RUN mode when a communications error occurs, without displaying an error message dialog box.
- OFF: The Display Section will stop running when a communications error occurs and an error message dialog box will be displayed. Press the **OK** Button in the error message dialog box to return to RUN mode. The default setting is OFF.

**Time-out Interval**

Set the time before a timeout error occurs when a response is not received from the host. The timeout interval can be set to between 1 and 10 (unit: s). Input the value by using the tenkey or the Up (△) and Down (▽) buttons that are displayed when the display area is pressed. The default setting is 3 s.

**Note** Set the time-out interval to 3 s min. when using 1:N NT Links. If the time-out interval is less than 3 s, abnormal communications may occur.

**Retry Counts**

Set the number of retries for communications before an error screen will be displayed, when a communications error occurs while communicating with the host. If communications are unsuccessful after the number of communications retries specified here have been executed, processing set for the communications auto return will be executed. The number of retries can be set to between 0 and 255 times. Input the value by using the tenkey or the Up (△) and Down (▽) buttons that are displayed by pressing the display area. The default setting is 5 retries.

**Note** Set the retry counts to 5 retries min. when using 1:N NT Links. If less than 5 retries is set, abnormal communications may occur.

**Port Communications Method and Communications Type**

Set the communications method for serial ports A and B, for Ethernet, and for Controller Link. The right half of the screen will change according to the settings.



- Note**
- (1) To change the communications method for another port, the **Write** Button must be pressed before continuing. The settings will not be saved if the communications method is switched without pressing the **Write** Button.
  - (2) For details on Temperature Controller and Memory Link setting methods and other procedures, refer to the *NS Series Host Connection Manual* (V085).

(3) For details on Host Link setting methods and other procedures, refer to the *NS Series Host Connection Manual (Host Link)*.

**Supported Communications Method Combinations**

It is not possible to connect via 1:N NT Links with both serial ports A and B at the same time. It is not possible to use a Bar Code Reader with both serial ports A and B at the same time. It is also not possible to use a modem with both serial ports A and B at the same time.

Controller Link cannot be used with the Display Section of the NSJ Controller. Serial ports A and B, Ethernet and Controller Link can be used in any combination with other communications methods.

Serial ports A and B and Ethernet, however, cannot be all used simultaneously (except when using a Bar Code Reader).

**Note** Serial ports A and B and Ethernet can be set to be used simultaneously, but operations may be unstable (except when using a Bar Code Reader). Therefore, do not set all the ports to be used simultaneously.

**Interface Setting**

This setting is not used with the NSJ Controller. Leave it set to *Disable*.

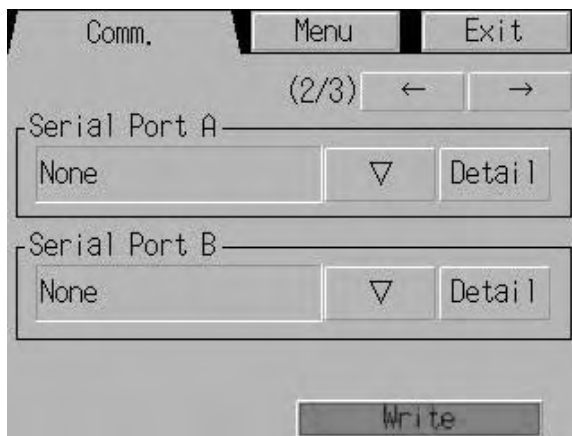

**8-6-2 Setting 1:1 NT Link**

Select the **Comm** Tab from the System Menu, and press the **NT Link 1:1** Button as the communications method for serial port A or B.

After setting, press the **Write** Button to save the setting.



When 1:1 NT Link is selected, there are no detailed settings.

### 8-6-3 Setting High-speed 1:N NT Links (Standard, High-speed)

Select the **Comm** Tab from the System Menu, and press the **NT Link 1:N** Button as the communications method for serial port A or B.

The setting items for high-speed 1:N NT Links will be displayed on the right side of the screen. Set the unit number and communications speed.

After setting, press the **Write** Button.

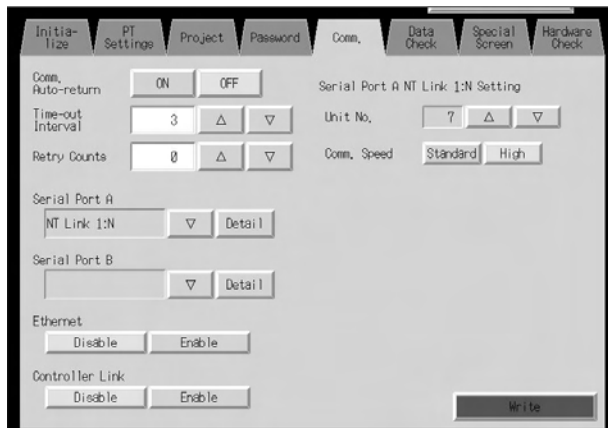

#### Communications Conditions for 1:N NT Links

Setting item	Function	Settings
Unit number	Sets the unit number.	0 to 7
Communications Speed	Sets the communications speed.	Standard, high-speed

**Note** Unit numbers are used to differentiate nodes when more than one NS-series PT or NSJ Controller is connected to the same host. The unit numbers that can be set depend on the host used, as follows:

- C200HE(-Z):  
Unit numbers 0 to 3 (up to four nodes for each port of the host)
- C200HG(-Z), C200HX(-Z), CS1G/H, CS1G/H-H, CQM1H, CJ1G, and CJ1G/H-H:  
Unit numbers 0 to 7 (up to eight nodes for each port of the host)

Refer to *4-2 1:N Host Connection* in the *NS-Series PT Setup Manual (V083)* for the host settings.

### 8-6-4 Setting Ethernet

To use Ethernet, select the **Comm** Tab from the System Menu and press the **Enable** Button.

The setting items for Ethernet will be displayed on the right side of the screen. Display and set the network address, node address, IP address, subnet mask, and default gateway. The MAC address and IP address table displays are also available.

After setting, press the **Write** Button.

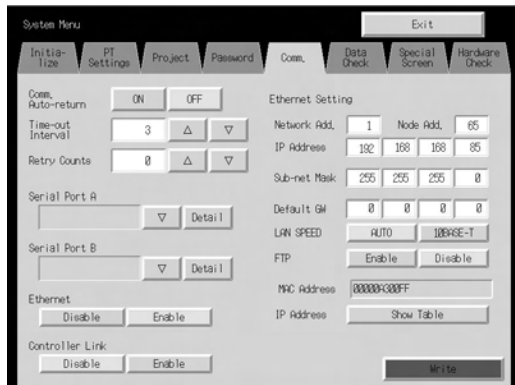

#### Setting Ethernet Communications Conditions

Setting item	Function	Settings
Network Add.	Sets the network address used for Ethernet communications.	1 to 127
Node Add.	Sets the local node address.	0 to 254
IP address	Sets the local IP address.	0.0.0.0 to 255.255.255.255 (See note.)
Subnet	Sets the subnet mask of the local node.	0.0.0.0 to 255.255.255.255
Default gateway	Sets the IP router.	0.0.0.0 to 255.255.255.255
MAC address	Displays the MAC address (device-specific information to identify each device connected to the network.)	Read-only
LAN SPEED	Selects the method used to set the Ethernet baud rate.	Automatic switch or fixed 10Base-T
FTP	Selects whether or not to use the FTP server.	Enable or disable
IP address table display	Displays the node numbers and IP addresses of other nodes connected to Ethernet.	Read-only

**Note** Do not set the following values for the IP address.  
 Host ID with all bits set to 0 or 1 (e.g., **192.168.21.0**).  
 Net ID with all bits set to 0 or 1 (e.g., **255.255.21.16**).  
 Subnet ID with all bits set to 1 (e.g., **192.168.255.16**).  
 IP addresses that begin with 127 (e.g., **127.35.21.16**).



### 8-6-5 Setting the Controller Link Network

The Controller Link Network function is supported by NS-series PTs. It is not supported by NSJ Controllers.

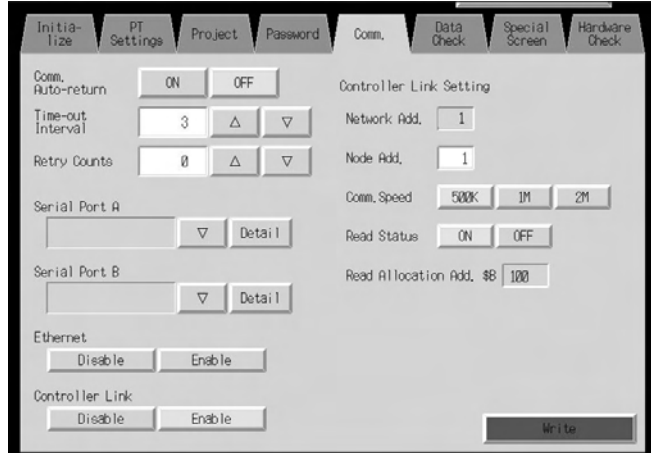

### 8-6-6 Setting Bar Code Readers

The Display Section has a Bar Code Reader input function allowing input of barcode data as character strings in String Display & Input objects. The methods for setting the communications conditions with the Bar Code Reader are described here.

- Note**
- (1) Refer to 3-4 *Connecting to Bar Code Readers* in the *NS-Series PT Setup Manual* (V083) for information on connecting Bar Code Readers.
  - (2) The Bar Code Reader can be connected to either serial port A or serial port B only.

Set the communications conditions and confirmation method for the Bar Code Reader using the following procedure from the System Menu.

- 1,2,3...**
1. Set the Bar Code Reader's communications method for serial port A or serial port B. The setting items for the Bar Code Reader will be displayed on the right side of the screen.
  2. Set the communications speed, data bits, stop bits, parity, and input method. After setting, press the **Write** Button to save the settings.

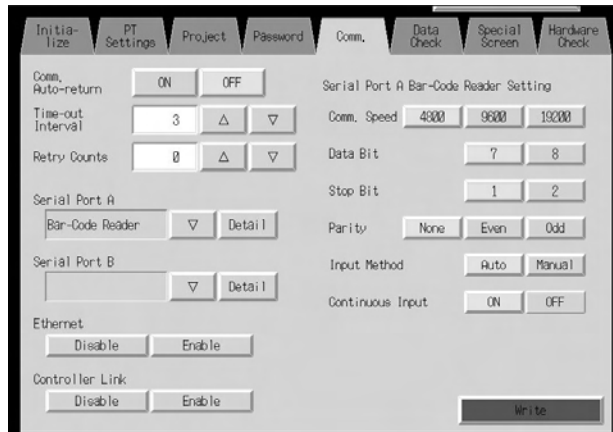

**Setting Communications Conditions for Bar Code Reader Mode**

Setting item	Function	Settings
Comm. speed	Sets the communications speed for communications with the Bar Code Reader.	4800, 9600, or 19200 (bps)
Data bits	Sets the data bit length.	7 or 8 bits
Stop bits	Sets the data stop bit length.	1 or 2 bits
Parity	Sets the data parity bits.	None, odd, or even
Input method	Sets the confirmation method used after inputting data in the input field.	Auto or manual confirmation
Continuous input	Sets continuous barcode input to Yes or No.	Yes or No

**8-6-7 Modem Settings**

Data can be transferred from a personal computer to the NSJ Controller through a modem. The method used to set the data transfer conditions for the modem is described here.

- Note**
- (1) Refer to *10-1 Transferring Data to the PT* in the *CX-Designer Operation Manual (W088)* for details on modem types and connections.
  - (2) The modem can be connected to either serial port A or serial port B, but not to both at the same time.

Set the communications conditions for the modem from the System Menu using the following procedure.

- 1,2,3...**
1. Set the communications method for serial port A or serial port B to the modem, and press the **Detail** Button.
  2. The settings for the modem will be displayed on the right side of the screen. Set the communications speed. After the setting is entered, press the **Write** Button to save it.



**Setting Communications Conditions for Modem Data Transfers**

Setting item	Function	Settings
Comm. Speed	Sets the communications speed.	9600, 19200, 38400, 57600, or 115200 (bps)

## 8-7 Screen Data Check

Registered screens (numbers 0 to 3,999) can be displayed and checked using operations from the System Menu.

- Note**
- (1) The screen displayed when checking screen data is a sample and cannot be used to communicate with the host. The flicker function is also disabled.
  - (2) Only the user screens (0 to 3,999) can be displayed. System screens cannot be displayed.

Display check screens by using the following procedure from the System Menu.

- 1,2,3...** 1. Select the **Data Check** Tab.

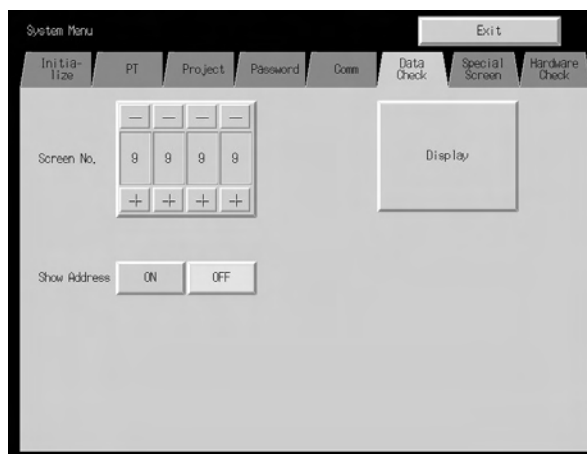

- 2. Set the screen number and press the **Display** Button to display the screen as a sample.
- 3. Press the **ON** Button next to the *Show Address* heading before displaying the sample screen to display the set addresses instead of labels for functional objects.

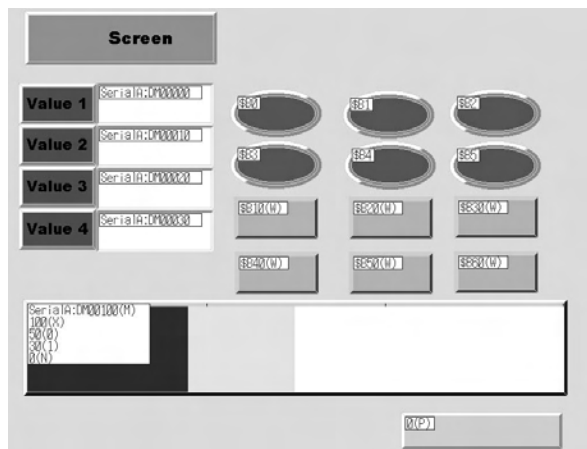

- 4. Press any part of the sample screen that is displayed to return to the Screen Data Check Screen.

**Note** Addresses are not displayed for data block tables.

## 8-8 Special Screens

These screens are used to display the data logs, device monitor, communications test, and version information.

Item	Function
Alarm history	Displays the alarm history.
Operation log	Displays the operation log.
Error log	Displays the error log.
Special function	Performs the following special functions.
NSJ Troubleshooter	Used to troubleshoot errors that have occurred in the NSJ Controller.
Device monitor	Switches PLC/NSJ Controller operating modes, displays and changes specified PLC/NSJ Controller addresses, and displays and deletes PLC/NSJ Controller error data. Refer to 8-8-4 <i>Device Monitor</i> for information on how to display the Device Monitor Screen. Refer to Device Monitor in 2-18 <i>Special Functions</i> in the <i>NS-Series PT Programming Manual (V073)</i> for details on the device monitor.
Communications test	Checks NSJ Controller communications functions.
USB device list	Displays a list of the devices connected to the USB port.
Display Capture Data	Displays video capture data or screen capture data stored in a Memory Card.
Transfer Memory Card	Transfers screen data and the system program in the NSJ Controller to a Memory Card.
PLC Data Trace	Reads the results of a data trace executed in the PLC and displays the results in a time chart. The data trace parameters can also be set.
Ladder Monitor	Enables monitoring the execution status of the ladder program in the Controller Section or a different PLC.
System Version	Displays information on the NSJ Controller versions.

Details on how to use the functions are explained here.

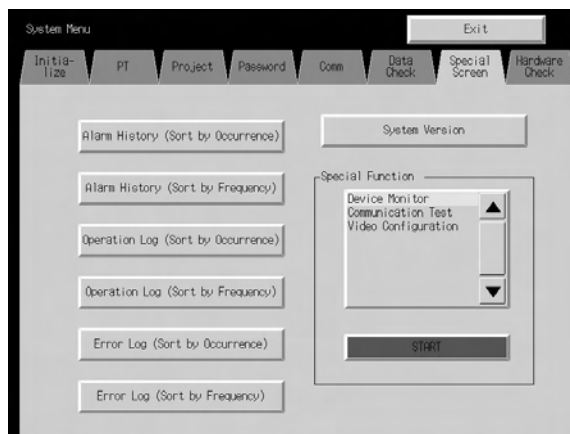

### 8-8-1 Alarm History

This function displays the alarm history. The alarm history can be displayed in order of occurrence or frequency.

Display alarm history data by using operations from the Special Screen Tab Page in the System Menu, as follows:

- 1,2,3... 1. Press the **Alarm History (Sort by Occurrence)** Button or **Alarm History (Sort by Frequency)** Button to display the history contents.

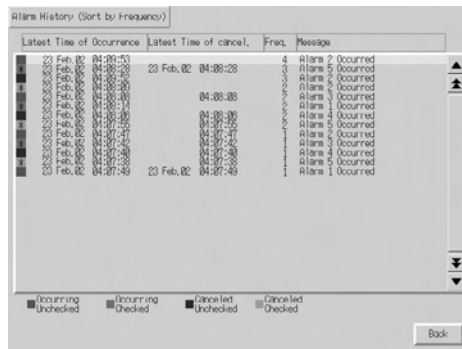
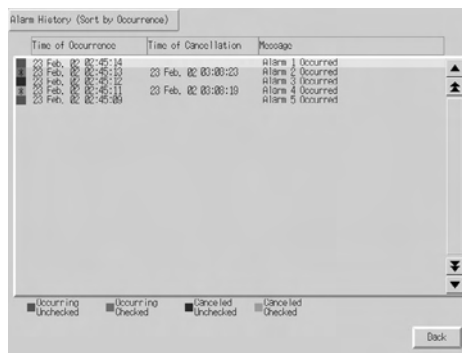

2. Press the **Back** Button to return to the Special Screen.

**Note** Refer to *Alarm/Event History in 2-18 Special Functions* in the *NS-Series PT Programming Manual (V073)* for details on the alarm history function.

### 8-8-2 Operation Log

This function displays the operation log. The operation log can be displayed in order of occurrence or frequency.

Display operation log data by using operations from the Special Screen Tab Page in the System Menu, as follows:

- 1,2,3... 1. Press the **Operation Log (Sort by Occurrence)** Button or **Operation Log (Sort by Frequency)** Button to display the operation log contents.

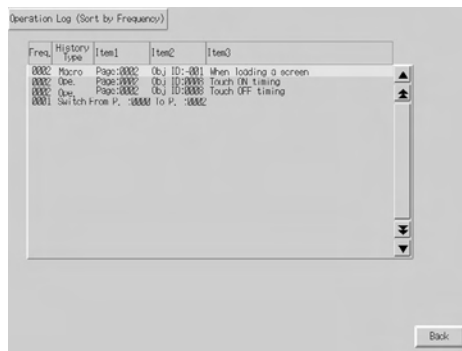

2. Press the **Back** Button to return to the Special Screen.

**Note** Refer to 8-2-4 *Initializing and Saving the Operation Log* in this manual and *Operation Log* in 2-18 *Special Functions* in the *NS-Series PT Programming Manual (V073)* for details on the operation log.

### 8-8-3 Error Log

This function displays the macro error history. Macro errors can be displayed in order of occurrence or frequency.

Display error log data by using operations from the Special Screen Tab Page in the System Menu, as follows:

- 1,2,3... 1. Press the **Error Log (Sort by Occurrence)** Button or **Error Log (Sort by Frequency)** Button to display the error log contents.

Error Log (Sort by Occurrence)

Time of Occurrence	Page No.	Object ID	Macro ID	Error Type
23 Feb, 02 23:54:14	0001	0017	0000	Incorrect program
23 Feb, 02 23:54:16	0001	0013	0000	0 division occurs
23 Feb, 02 23:54:25	0001	0017	0000	Incorrect program
23 Feb, 02 23:54:27	0001	0015	0000	BCD code error
23 Feb, 02 23:54:29	0001	0010	0000	Argument value incorrect
23 Feb, 02 23:54:31	0001	0017	0000	Incorrect program

Back

Error Log (Sort by Frequency)

Freq.	Page No.	Object ID	Macro ID	Error Type
0003	0001	0017	0000	Incorrect program
0002	0001	0013	0000	0 division occurs
0002	0001	0015	0000	BCD code error
0001	0001	0010	0000	Argument value incorrect

Back

2. Press the **Back** Button to return to the Special Screen.

**Note** Refer to 8-2-5 *Initializing and Saving the Error Log* in this manual and *Error Log* in 2-18 *Special Functions* in the *NS-Series PT Programming Manual (V073)* for details on the error log.

### 8-8-4 Device Monitor

The device monitor is an expansion function of the NSJ Controller.

The device monitor has the following functions.

- Switches the PLC/NSJ Controller operating modes.
- Displays, changes, and performs force-sets/resets of current values in specified addresses (registered monitor).
- Displays a list of the current values (continuous monitor) in consecutive addresses (DM, EM, and WR Area words).
- Displays PLC/NSJ Controller error information (error logs) and deletes the errors (error information).

The procedure for opening the Device Monitor Screen is explained here. Refer to *Device Monitor* in 2-18 *Special Functions* in the *NS-Series PT Programming Manual (V073)* for details on the function and operation methods.





### 8-8-5 Communications Test

This function checks whether communications are enabled, by performing simple communications.

Display the Communication Test Screen by using operations from the Special Screen Tab Page in the System Menu, as follows:

- 1,2,3... 1. Select **Communication Test** from the Special Functions List Box, and press the **START** Button.

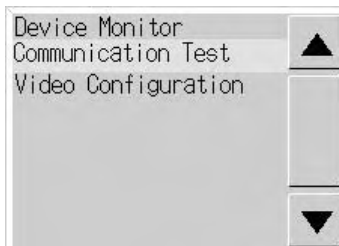

2. Press the **Communication Test** Button to switch to the Communications Test Screen.

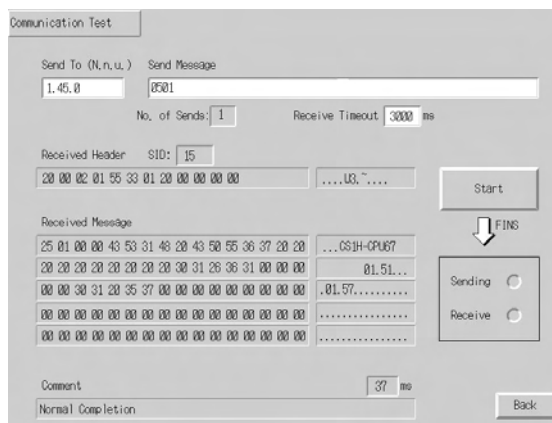

3. Set each of the setting items, as follows:

#### Setting and Display Items in Communication Test Screen

Item	Details
Send to	Sets the address of the transmission destination in the format <b>(network address).(node address).(unit number)</b> . Sets the following addresses when performing a communications test for a node connected to serial port A or B. <ul style="list-style-type: none"> <li>• Serial port A: <b>111.1.0</b></li> <li>• Serial port B: <b>112.1.0</b></li> </ul>
Send message	Sets the FINS command being to be sent.
Number of sends	Displays the number of times messages are transmitted. The number of times is fixed to 1.
Receive Time-out	Sets the time before the message timeout occurs. Displays an error message when the timeout time is exceeded after transmission.  The setting time is applicable for Ethernet only. For serial communications, the timeout monitor time set from the Comm Tab is used.

4. Press the **Start** Button to start transmission. The sending indicator will remain lit until the transmission is completed. After transmission, the receiving indicator will remain lit until reception is completed.

- If communications are normal, a response will be received from the transmission destination and the following items will be displayed. Refer to the *FINS Command Reference Manual (W227)* for details on FINS commands and information displayed in comments.

**Display Items in Communication Test Screen**

Item	Details
SID (See note 1.)	The SID used for transmission is displayed as a hexadecimal. The SID is incremented between 0 and 0xFF and returns to 0 after 0xFF is exceeded.
Received header	Displays the FINS header that is received. (See note 2.)
Received message	Displays the received message.
ms	Displays the time lapsed in ms from sending the FINS command until receiving the FINS response.
Comment	Displays the status, such as "normal completion," according to the completion code after reception.

- Note**
- (1) SID is the source process ID.
  - (2) The FINS header is the header that precedes the FINS command. Refer to the *FINS Command Reference Manual (W227)* for details on FINS commands.

- Press the **Back** Button to return to the Special Screen.

**8-8-6 USB Device List**

This function displays information about the devices connected to the Display Section's USB port.

Item	Details
Device list	A list of the devices currently connected to the USB port is displayed.
Driver list	A list of connectable USB devices that are supported by the NS Series is displayed.

- 1,2,3...**
- Select **USB Device List** from the Special Functions List Box, and press the **START** Button.

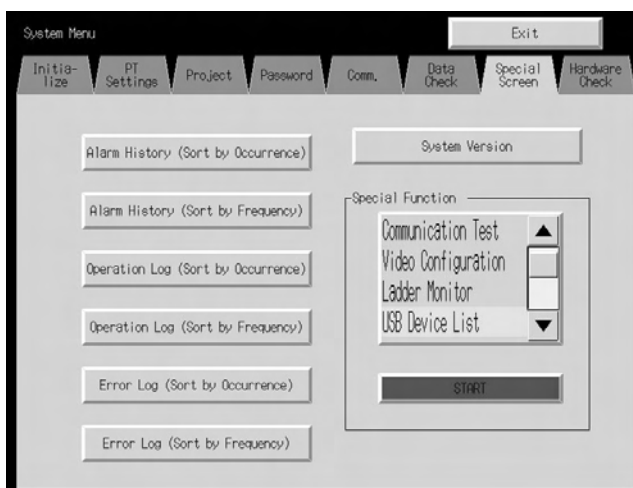

2. The USB Device List Window will be displayed.



A list of USB devices currently connected and a list of USB devices supported by the NS Series are displayed. Press the **Update** Button to reconfirm the connected USB devices and refresh the display.

3. Press the **Return** Button to return to the Special Screen.

### 8-8-7 Display Capture Data

Video capture data and screen capture data stored in a Memory Card can be displayed. Perform the following procedure under Special Screen Tab on the System Menu.

- 1,2,3...**
1. Select **Display capture data** from the Special Function List Box and press the **START** Button.

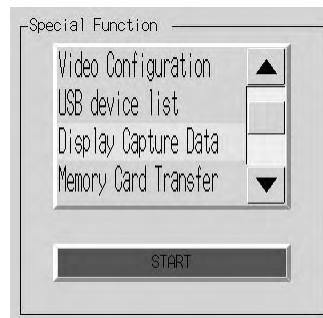

2. The Capture Data Display Screen will be displayed.

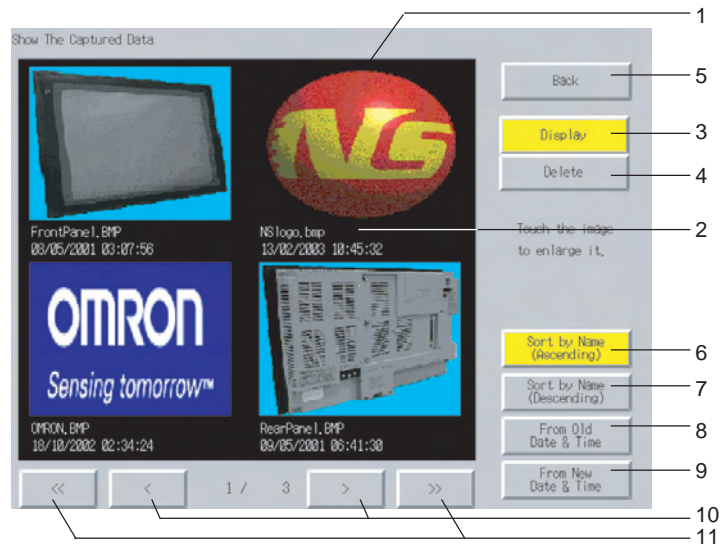

No.	Item	Details
1	Data	Displays a BMP file stored in the LOG folder in the Memory Card.
2	File name	Display the file name and time stamp of the BMP file.
3	Display	Press the <b>Display</b> Button and then the bitmap to enlarge the display. Press the <b>Print</b> Button to print the BMP file. Press the <b>Full Screen</b> Button to display the BMP file in original format. The original display divided into four areas will return if BACK is pressed.
4	Delete	The following dialog box will appear if the Delete Button and then the bitmap are pressed. <div style="text-align: center;"> </div> Press the <b>Yes</b> Button to delete the BMP. The capture display screen will return if the <b>No</b> Button is pressed.
5	Back	Press to return to the Special Screens Tab Page.
6	Sort by name (Ascending)	Press to sort the bitmap file names alphabetically.
7	Sort by name (Descending)	Press to sort the bitmap file names reversed alphabetically.
8	From Old Date & Time	Press to sort the bitmap file names starting from the oldest one.
9	From New Date & Time	Press to sort the bitmap file names starting from the newest one
10	< Button and > Button	Press to display the next or previous page (4 files) of bitmaps.
11	<< Button and >> Button	Press to display the page back or forward by 3 pages (12 files) of bit-maps.

### 8-8-8 Memory Card Transfers

With a Memory Card inserted into the Display Section (MC (DISPLAY)), procedures can be performed using the Special Screens Tab Page of the System Menu. You can manually transfer screen data and system programs without manipulating the DIP switch on the Display Section. Refer to *11-1 Backup Function* for the actual procedures.

### 8-8-9 NSJ Troubleshooter

The NSJ Troubleshooter enables troubleshooting errors that have occurred in the Controller Section or DeviceNet Section. Refer to *10-2 NSJ Troubleshooter Function* for the actual procedures.

### 8-8-10 Ladder Monitor (NSJ12, NSJ10, and NSJ8 Only)

The Ladder Monitor function can be used to monitor the execution status of the ladder program in the Controller Section or in the CPU Unit of another PLC.

Refer to *SECTION 9 Ladder Monitor* for details.

### 8-8-11 PLC Data Trace (NSJ12, NSJ10, and NSJ8 Only)

The PLC Data Trace function uses the data trace function in the Controller Section of an NSJ Controller and displays the results of the data trace on the Display Section.

After receiving the data trace execution command from the Display Section, the Controller Section establishes the specified trigger condition, reads the specified bit status according to the sampling conditions, and stores the sampled data in the Controller Section's Trace Memory.

The Display Section reads the data stored in the Controller Section and displays that data on the screen as a time chart.

The PLC Data Trace function can be used in NSJ12, NSJ10, and NSJ8 Controllers with Display Section system version 6.6 or higher.

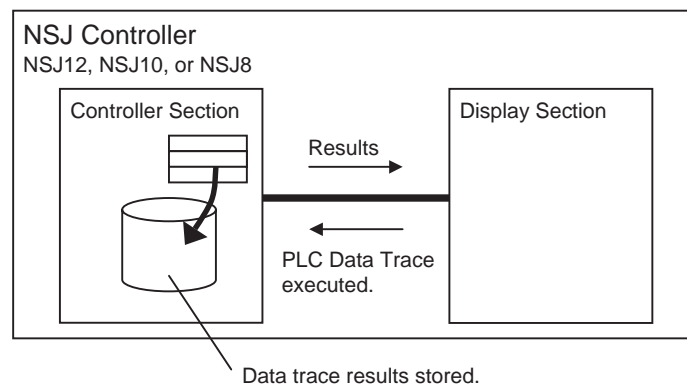

This section explains only how to open the PLC Data Trace Screen. Refer to *2-18 Special Functions in the NS Series Programming Manual (Cat. No. V073)* for details on the specifications and operation of the data trace function.

Display the PLC Data Trace Screen by using operations from the Special Screen Tab Page in the System Menu, as follows:

- 1,2,3...** 1. Select **PLC Data Trace** from the Special Functions List Box, and press the **START** Button.

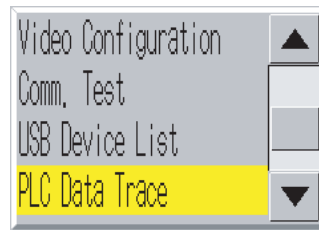

2. The PLC Data Trace Screen will be displayed.

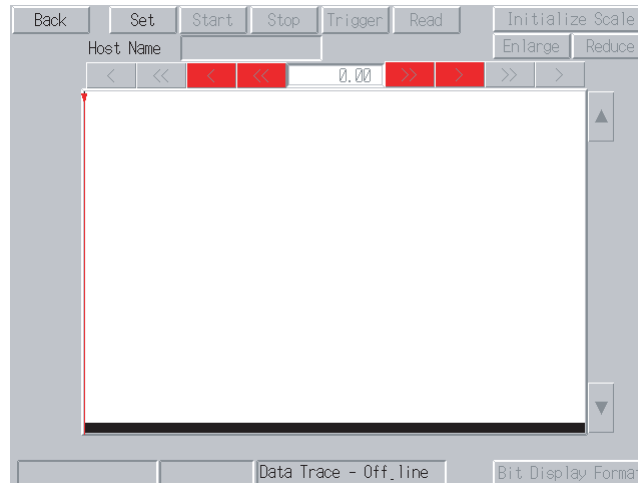

3. Press the **Back** Button to return to RUN mode.

## 8-8-12 System Version Display

This function displays information on NSJ Controller versions.

Display the Version Display Screen by using operations from the Special Screen Tab Page in the System Menu, as follows:

- 1,2,3...** 1. Simultaneously press two of the four corners of the touch panel. The System Menu will be displayed.



2. Press the **Special Screen Button**.

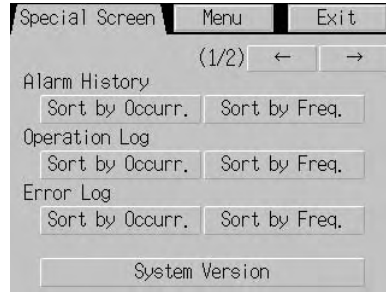

3. Press the **System Version Button**.

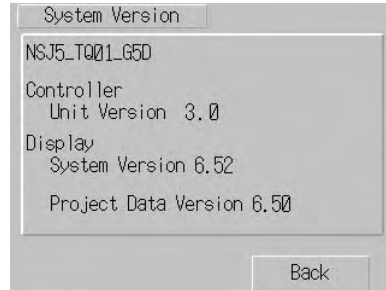

4. Press the **Back Button** and then the **Exit Button**.

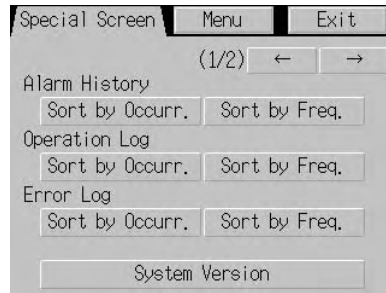

## 8-9 Hardware Check

The hardware check is used to check the following functions.

Item	Function
LCD check	Checks the LCD.
Touch switch check	Checks touch panel inputs.



### 8-9-1 LCD Check

This function checks whether the LCD (screen display) is operating normally. Check the LCD by using operations from the Hardware Check Tab Page in the System Menu, as follows:

- 1,2,3... 1. Press the **LCD Check** Button to switch to the LCD Check Screen.

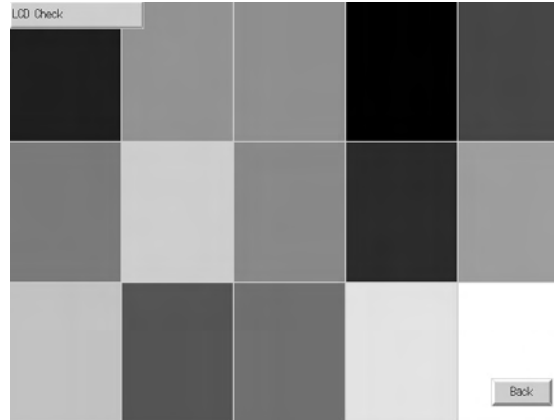

2. Press the **Back** Button to return to the Hardware Check Screen.

### 8-9-2 Touch Switch Check

This function checks whether the touch switches are operating normally. Check the touch panel by using operations from the Hardware Check Tab Page in the System Menu, as follows:

- 1,2,3... 1. Press the **Touch Switch Check** Button to switch to the Touch Switch Check Screen.
2. Press the screen. If the part of the screen touched is highlighted in inverse video, the touch switch is operating normally.

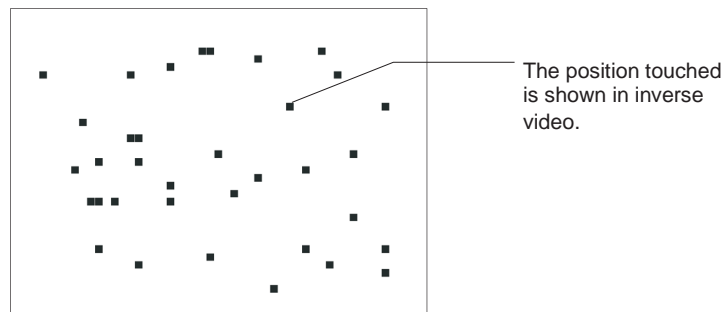

3. Press the button in the top right corner to return to the Hardware Check Screen.

**Note** Two points cannot be touched at the same time on the Touch Panel Check Screen.



# SECTION 9

## Ladder Monitor

This section describes the ladder monitor function.

9-1	Using the Ladder Monitor . . . . .	178
9-2	Starting the Ladder Monitor . . . . .	178
9-2-1	Starting the Ladder Monitor from the System Menu . . . . .	178
9-2-2	Starting the Ladder Monitor from a User Screen . . . . .	179
9-2-3	Using I/O Comments . . . . .	180
9-2-4	Ladder Monitor When Connecting Display Section to Another PLC through a Serial Port . . . . .	181
9-2-5	Ladder Monitor When Connecting Display Section to Another PLC through Built-in Ethernet Port . . . . .	181
9-2-6	Using the Ladder Monitor for the Controller Section . . . . .	181
9-3	Exiting Ladder Monitor . . . . .	182

## 9-1 Using the Ladder Monitor

Ladder monitoring is provided as an expansion function for the NSJ Controller. It includes the following operations:

- The user program in the built-in Controller Section or another PLC is displayed in ladder format on the Display Section (10 rows x 8 lines max.).
- The ON/OFF status of bits and the present values of special instruction operands (words) are displayed
- The location (program sections) to be displayed can be specified (search function).
- Present values specified words can be displayed and changed, and bit in specified words can be force-set/reset (multi-point I/O monitoring).
- The PLC operating modes can be changed.
- Errors that occur in the PLC (fatal and non-fatal errors) can be displayed and cleared.
- I/O comments can be displayed.

Only opening and closing the Ladder Monitor Window are described here. For details on operations, refer to the *NS-series Ladder Monitor Operation Manual* (provided with NS-series Ladder Monitor software).

The ladder monitor function can be used with system version 6.6 and higher for NSJ12, NSJ10, and NSJ8 Display Sections.

## 9-2 Starting the Ladder Monitor

Two methods can be used to start the Ladder Monitor.

- 1,2,3...
1. Select **Ladder Monitor** from the Special Screen Tab Page of the System Menu
  2. Set \$SW0 to 4036 from a user screen.

### 9-2-1 Starting the Ladder Monitor from the System Menu

- 1,2,3...
1. Turn ON the power to the Display Section and press two of the four corners of the Display Section touch panel simultaneously with the NSJ Controller in normal operating status to display the system menu.

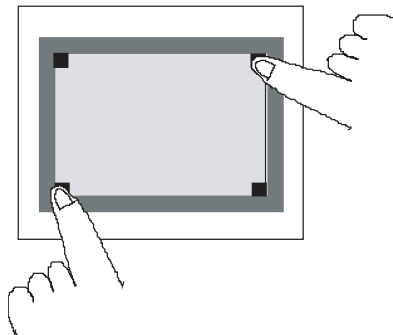

2. Press the **Special Screen Tab**.

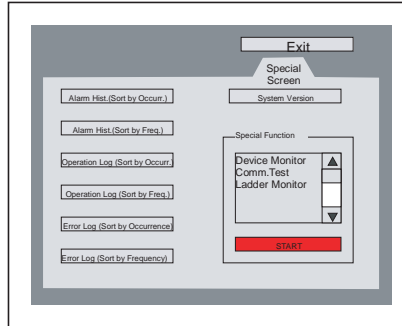

3. Select **Ladder Monitor** from the Special Function List and press the **START** Button.

The Ladder Monitor will start and Main Screen will appear.

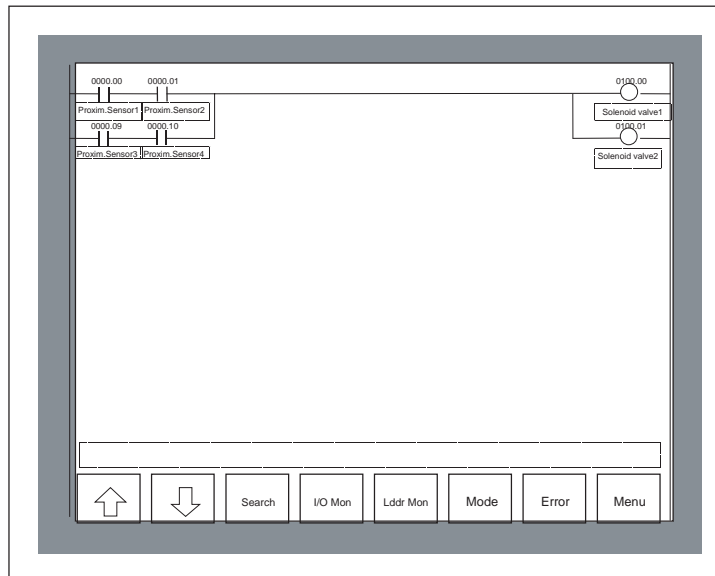

**Note** The Display Section reads I/O comments data from the Memory Card in the Display Section if I/O comments are set. Up to 30,000 comments (15,000 maximum each for global comments and local comments) can be displayed. The comments exceeding 30,000 will not be displayed.

## 9-2-2 Starting the Ladder Monitor from a User Screen

- 1,2,3... 1. Use a macro, word button, or other object to set \$SW0 to 4036 BCD (FC4 hex)

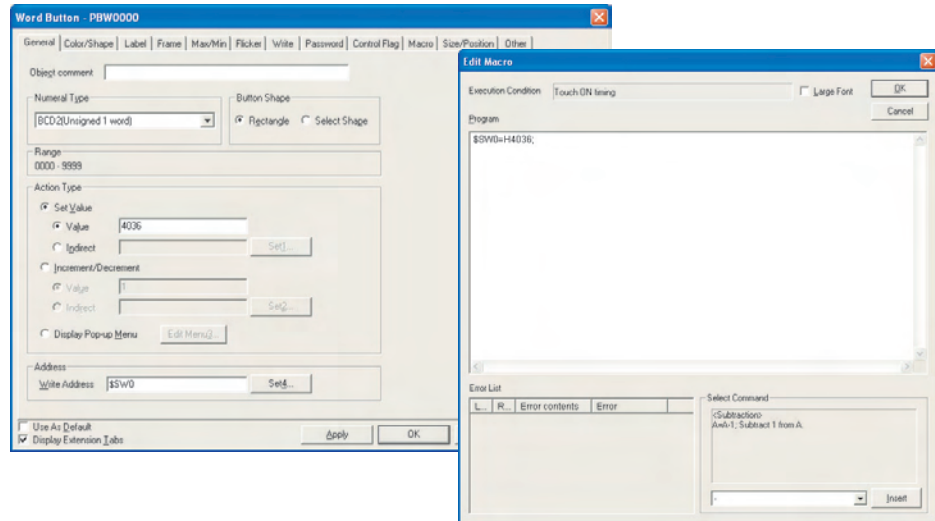

2. Activate the object on the Display Section. The Ladder Monitor will be started.

**Note**

- (1) To set \$SW0, use the data type (binary/BCD) set in the Initial Value for System Memory (select **PT - System Settings** and then click the **System Memory List** Button on the Initial Tab Page in the CX-Designer).
- (2) Confirm system safety before turning the power ON/OFF or resetting. Otherwise, the system may operate unpredictably.
- (3) When using the Ladder Monitor, CX-Programmer, or Programming Console while the Ladder Monitor is working, carefully check that the system is safe before performing the following actions.
  - Changing monitored data
  - Changing the operating mode
  - Force setting/resetting bits
  - Changing set values or present values

### 9-2-3 Using I/O Comments

- 1,2,3... 1. Press the two upper corners of the Main Screen. The System Setting Screen will appear. Settings can also be selected from the Main Screen menu.
2. Select I/O Comment File Setting and press the **OK** Button.
3. Select the host to be set and press the **Regist/Change** Button.
4. Select the I/O comment file to be displayed, and then press the **Setting** Button.
5. Press the **Close** Button.

**Note**

- (1) Use the same project file as the source for the CXT file and as the source of the program transferred to the PLC for which the Ladder Monitor is to be used. If the source project file is not the same, I/O comments and addresses may not correspond correctly.
- (2) The I/O comment file for the Ladder Monitor must be saved in the Memory Card or in the Display Section in advance.
- (3) If there is an I/O comment file with the same name in both the Display Section and the Memory Card, the I/O comment file in the Display Section will be used.

### 9-2-4 Ladder Monitor When Connecting Display Section to Another PLC through a Serial Port

Connect one of the serial ports, port A or B, on the Display Section to another PLC and enable communications in 1:N NT Link communications mode.

Start the Ladder Monitor. Communications will start with the other PLC and Ladder Monitor will start. The port through which to monitor must be selected in the following cases.

- To monitor the PLC connected to port B when PLCs are connected to both port A and B on the Display Section
- When the PLC to be monitored is not the one that was monitored the last time the Ladder Monitor was used
- When the PLC to be monitored is to be changed while using the Ladder Monitor

Use the following procedure to select the PLC to monitor.

- 1,2,3...**
1. Press the **Menu** Button in the Ladder Monitor screen and select **Communication setting** from the menu.
  2. Select either serial *PortA* or *PortB* as the *Comms. Method* from the Communication Setting Dialog Box and click the **OK** Button. If the Comm. Setting Dialog Box is displayed, press the **Connecting** Button.

### 9-2-5 Ladder Monitor When Connecting Display Section to Another PLC through Built-in Ethernet Port

Connect the built-in Ethernet port to the other PLC and enable communications. Then start the Ladder Monitor and select the port using the following procedure.

- 1,2,3...**
1. Press the **Menu** Button on the Ladder Monitor screen and select **Communication setting** from the menu.
  2. Select *Ethernet/Controller* as the *Comms. Method* from the Communication Setting Dialog Box and click the **OK** Button.
  3. Select the host name of the host connected via the Ethernet port and click the **OK** Button. The main menu screen will return. If the Comm. Setting Dialog Box is displayed, press the **Connecting** Button.

### 9-2-6 Using the Ladder Monitor for the Controller Section

Start the Ladder Monitor and set the host using the following procedure.

- 1,2,3...**
1. Press the **Menu** Button in the Ladder Monitor screen and select **Communication setting** from the menu.
  2. The Communication Setting Dialog Box will appear. Select *Controller* as the *Comm. Method*.
  3. Select the host name of the Controller Section for the *Host name* and click the **OK** Button. The Main Screen will appear. If the Comm. Setting Dialog Box is displayed, press the **Connecting** Button.

- Note**
- (1) The communications path that was being used for the Ladder Monitor will be saved when the Ladder Monitor is exited. This communications path will be used by default the next time the Ladder Monitor is started.
  - (2) If the communications path that was last used for the Ladder Monitor is not saved when the Ladder Monitor is started, a search will be automatically made in the following order for PLCs to be monitored. Serial A, Se-

rial B, Ethernet, and Controller. (For Ethernet monitoring will be performed for the first PLC registered in as a host.)

- (3) If a PLC that can be monitored is not found when the Ladder Monitor is started or the host is being changed, the Connection/Communication Setting Dialog Box will appear. Select the Comms. Method to connect to the PLC.

## 9-3 Exiting Ladder Monitor

- 1,2,3...**
1. Press the **Menu** Button on the Main Screen and select **Exit** from the menu.
  2. The Exit Application Dialog Box will appear. Press the **OK** Button.
  3. The Ladder Monitor will be ended and the screen that was displayed before the Ladder Monitor was started will appear.

**Note** Confirm system safety before turning the power ON/OFF or resetting. Otherwise, the system may operate unpredictably.

# SECTION 10

## Error Processing and Troubleshooting

This section describes error processing and troubleshooting procedures needed to keep the NSJ Controller operating properly.

10-1	Troubleshooting and Maintenance . . . . .	184
10-1-1	Errors Occurring at Startup. . . . .	184
10-1-2	Errors Occurring with the Controller Section Connected. . . . .	185
10-1-3	Errors Occurring during Display Section Operation . . . . .	187
10-1-4	Other Errors . . . . .	188
10-2	NSJ Troubleshooter Function . . . . .	189

## 10-1 Troubleshooting and Maintenance

When an error occurs during operation, use the following table to identify and correct the error. For additional error processing information, refer to *Section 11 Troubleshooting* in the *CJ Series Programmable Controllers Operation Manual (W393)* and *7-3 Troubleshooting and Maintenance* in the *NS Series Programmable Terminals Setup Manual (V083)*.

### 10-1-1 Errors Occurring at Startup

Indicator status and Messages	Likely cause	Controller operation (See note.)	Corrective measures	
The RUN Indicator does not light. Nothing is displayed.	Power is not being supplied to the NSJ Controller. Power is not being supplied to Expansion Racks connected via an I/O Control Unit.	Operation will start without completing Inner Board initialization.	Check the connection points and supply power correctly. Check the power supply to the Expansion Racks.	
The RUN Indicator does not light. Nothing is displayed.	The power supply fuse is blown.		Replace the NSJ Controller.	
The RUN Indicator does not light. Nothing is displayed. The RUN indicator is lit orange, but nothing is displayed. The RUN indicator is lit green, but nothing is displayed.	The Display Section's system program is corrupted.	Operation will start without completing Inner Board initialization.	The backlight must be replaced. Contact your nearest OMRON representative. Replace the NSJ Controller.	
The indicator is flashing green and the buzzer goes ON and OFF repeatedly.	The backlight has malfunctioned.			
FATAL ERROR No. 01: Touch Panel	A touch panel error occurred.			
FATAL ERROR No. 02: SRAM	Hardware error in SRAM			
FATAL ERROR No. 03: MAC Address Error	Incorrect MAC address			
FATAL ERROR No. 04: Model type Identify Error	Hardware error (Built-in model code not readable.)			
ERROR No. 10: File System Error	File system is corrupted. (Hardware failure occurred or power was interrupted during writing.)			Use the recovery program to restore the system program.
ERROR No. 10: File System Error	File reading or program execution failed.			Automatically download the system program.
ERROR No. 11: Failure loading files	File reading failed.			
ERROR No. 11: Device check program error	Hardware check program is corrupted.			
ERROR No. 11: SRAM check program error	SRAM check program is corrupted.			
ERROR No. 11: IP Address Setting Error	IP address setting program is corrupted.			
ERROR No. 11: Device check program error	Hardware check program is corrupted (when DIP switch 6 is ON).	Inner Board initialization will continue. Operation will start.	Operation will start without completing Inner Board initialization.	
ERROR No. 12: Failure loading fonts	Font file reading failed (when DIP switch 6 is ON).			



Indicator status and Messages	Likely cause	Controller operation (See note.)	Corrective measures
ERROR No. 12: Installed system program is not applicable for this hardware.	The installed system program does not match the hardware.	Inner Board initialization will continue. Operation will start.	Automatically download the system program.
WARNING No. 20: Date and Time are not set	The year is not within the NSJ Controller's allowable range of 2000 to 2049.		Set the correct date with the Display Section's System Menu.
WARNING No. 21: SRAM previously broken...Initialization Complete	SRAM was initialized because a battery was not connected to retain SRAM contents or the capacity was insufficient.		Replace the battery.
WARNING No. 22: Memory Card Error	The Memory Card file is corrupted.		Connect the Memory Card to a computer to verify that the Memory Card's data is correct. If the battery voltage is too low, replace the battery.

**Note** Operation depends on the Controller's settings at startup. With the default settings, operation will start even if the Display Section has not completed initialization.

### 10-1-2 Errors Occurring with the Controller Section Connected

Indicator status and Messages	Likely cause	Controller Section operation	Corrective measures
The RUN indicator is lit red. Display Section: An error message indicates that a communications error occurred during data transfer. Controller Section: The ERR/ALM indicator is lit.	An error occurred in the Controller Section (WDT error).	Operation will stop.	Turn the power supply OFF and ON again. If the error recurs, replace the NSJ Controller.
The indicator is flashing red. Display Section: An error message indicates that a communications error occurred during data transfer.	A communications monitoring timeout occurred in the Controller Section.	---	
Display Section: An error message indicates that a communications error occurred during data transfer.	An Inner Bus error occurred.	This is a fatal error, so operation will stop.	
The indicator is lit red or flashing red. Controller Section: The RUN indicator is either lit or not lit and the ERR/ALM indicator is flashing.	Another kind of error occurred in the Controller Section.	Operation depends on the error, which may be a fatal or non-fatal error.	Use the NSJ Troubleshooter Function to check the error details. Correct the error according to the instructions in the CPU Unit's Operation Manual.
The indicator is flashing red. Controller Section: The RUN indicator is lit and the ERR/ALM indicator is flashing.	An error occurred in the built-in communications unit (built-in DeviceNet Unit). The DeviceNet Unit did not start up properly.	This is a non-fatal error, so operation will continue.	Use the NSJ Troubleshooter Function to check the error details. Correct the error according to the instructions in the <i>DeviceNet Operation Manual</i> .

<b>Indicator status and Messages</b>	<b>Likely cause</b>	<b>Controller Section operation</b>	<b>Corrective measures</b>
Display Section: An error message indicates that a communications error occurred during data transfer.	When connected to an Ethernet, Controller Link, or DeviceNet node, there was an incorrect communications setting, such as the network address, node address, or IP address.	Operation will continue.	Correct the communications settings.
Display Section: An error message indicates that a communications error occurred during data transfer.	When connected to an Ethernet, Controller Link, or DeviceNet node, a communications error occurred in the network carrying the transfer.		Correct the error according to the instructions in the relevant Communications Units' Operation Manuals.

### 10-1-3 Errors Occurring during Display Section Operation

Indicator status and Messages	Likely cause	Controller Section operation	Corrective measures
The RUN Indicator does not light. Nothing is displayed.	Power is not being supplied.	---	Check the connection points and supply power correctly.
The RUN Indicator does not light. Nothing is displayed.	The power supply fuse is blown.	---	Replace the NSJ Controller.
Status information is reflected in the Controller Section's status area, but nothing is displayed.	The backlight has malfunctioned.	Operation continues.	The backlight must be replaced. Contact your nearest OMRON representative.
There are errors from the touch panel.	Status information is reflected in the Controller Section's status area.		Test the touch panel's operation with the System Menu's Touch Switch Check function.
The RUN indicator is lit red. Display Section: An error message indicates that a communications error occurred during data transfer. Controller Section: The ERR/ALM indicator is lit.	An error occurred in the Controller Section (WDT error).	Operation will stop.	Turn the power supply OFF and ON again. If the error recurs, replace the NSJ Controller.
The indicator is flashing red. Display Section: An error message indicates that a communications error occurred during data transfer.	A communications monitoring timeout occurred in the Controller Section.		
Display Section: An error message indicates that a communications error occurred during data transfer.	An Inner Bus error occurred.		
The RUN indicator is lit red or flashing red. Controller Section: The RUN indicator is either lit or flashing and the ERR/ALM indicator is flashing.	Another kind of error occurred in the Controller Section.	Operation depends on the error, which may be a fatal or non-fatal error.	Use the NSJ Troubleshooter Function to check the error details. Correct the error according to the instructions in the CPU Unit's Operation Manual.
The RUN indicator is flashing red. Controller Section: The RUN indicator is lit and the ERR/ALM indicator is flashing.	An error occurred in the built-in communications unit (built-in DeviceNet Unit). The DeviceNet Unit did not start up properly.	This is a non-fatal error, so operation will continue.	Use the NSJ Troubleshooter Function to check the error details. Correct the error according to the instructions in the <i>DeviceNet Operation Manual</i> .
Display Section: An error message indicates that a communications error occurred during data transfer.	When connected to an Ethernet, Controller Link, or DeviceNet node, there was an incorrect communications setting, such as the network address, node address, or IP address.	Operation will continue.	Correct the communications settings.
Display Section: An error message indicates that a communications error occurred during data transfer.	When connected to an Ethernet, Controller Link, or DeviceNet node, a communications error occurred in the network carrying the transfer.		Correct the error according to the instructions in the relevant Communications Units' Operation Manuals.

### 10-1-4 Other Errors

Check the following items when the NSJ Controller is not operating as expected.

Error	Corrective measures
Cannot switch to MON/RUN mode.	<p>Check whether Controller Section DIP switch 7 was set to ON when the power was turned ON.</p> <p>After reading data from the simple backup Memory Card to the Controller Section, operation won't start until the power is turned ON again with DIP switch 7 set to OFF.</p>
Communications with the Controller Section are temporarily disabled when the Display Section's System Menu is written.	<p>When the Display Section's communications settings are changed and written, the Display Section is reset and communications with the Controller Section are also reset. The Display Section cannot communicate with the Controller Section until communications restart.</p>
NSJ Controllers cannot communicate with each other.	<p>Check whether the routing table is set correctly. If the routing table has not been created, set the Display Section's network routing table in the Controller Section.</p>
When the power is turned ON, "Connecting ..." is displayed and the Unit waits to connect.	<p>It is possible that a device is not connected properly to the serial port or the device's power supply is not ON. Check the serial port's communications settings, connected devices, and connecting cables.</p> <p>If no devices are connected to the serial port, set the port's communications settings to "Do not use."</p> <p>The power supply to Expansion Racks connected via an I/O Control Unit may be OFF. Check the power supply to the Expansion Racks.</p>
Items in the System Menu changed after transferring a project from the Support Software.	<p>When a project is transferred from the Support Software, setting items (such as communications settings) are also transferred.</p>
Screen data cannot be transferred.	<p>Verify that there isn't a communications cable connected to serial port C (PORT C).</p> <p>Serial port C (PORT C) functions primarily as a control port for data processing at the Controller Section and it is used when connecting a bar code reader by no-protocol communications or a Temperature Controller by Compo-Way/F communications.</p> <p>When connecting the Support Software, use serial port A/B (PORT A/PORT B).</p>
Cannot transfer data (screen data or ladder program) to or from the Memory Card.	<p>Check the Memory Card slot.</p> <p>The Memory Card slots used in the Display Section and Controller Section are different. Use the Display Section's Memory Card slot when transferring screen data and use the Controller Section's Memory Card slot when transferring the ladder program.</p>

## 10-2 NSJ Troubleshooter Function

The NSJ Troubleshooter Function can be used to read details on errors that occur in the Controller Section and built-in DeviceNet Unit, and help correct those errors. The NSJ Troubleshooter Function is one of the special screens in the Display Section's System Menu.

### Procedure

- 1,2,3... 1. Press two of the touch panel's four corners at the same time. The System Menu will be displayed.



2. Press the **Special Screen** Button. With an NSJ5 Controller, press the Left or Right Arrow Button to display other *Special Screens* (page 2/2). Select **NSJ Troubleshooter** and press the **Start** Button.



3. The NSJ Troubleshooter Function will start.

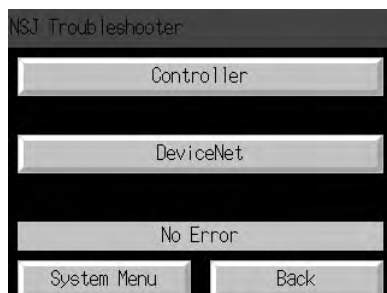

**Controller Section Troubleshooter Functions**

The following screen will be displayed when an error has occurred in the Controller Section.



Press the **Controller** Button to display the *Error Details* Screen. (In this case, a battery error has occurred.)

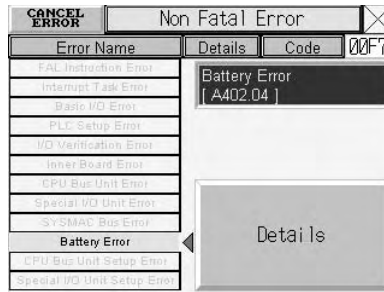

Press the **Details** Button to display details on the error.



**DeviceNet Troubleshooter Functions**

When the **DeviceNet** Button is pressed, the *DeviceNet Master Status* Screen will be displayed. If a DeviceNet error has occurred, the corresponding button will be displayed in reverse video.



The **Slave Detailed Status** Button can be pressed to display a list showing the participating status of the Slaves in the DeviceNet network.

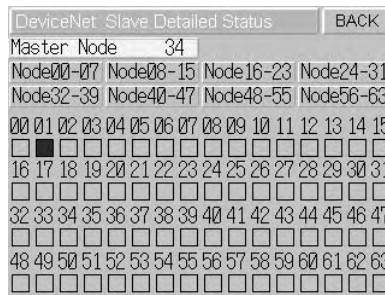

**Errors Shown in the Controller Section Troubleshooter**

The NSJ Troubleshooter displays the following errors that can occur in the Controller Section.

Error type	Error name	Error details
Fatal error (A39500)	Memory error (A40115)	<ul style="list-style-type: none"> <li>• User program error (A40300)</li> <li>• PLC Setup error (A40304)</li> <li>• Registered I/O table error (A40305)</li> <li>• Routing table error (A40307)</li> <li>• CPU Bus Unit settings error (A40308)</li> <li>• Memory Card write error (A40309)</li> <li>• Flash memory error (A40310)</li> </ul>
	I/O bus error (A40114)	---
	Unit/Rack number duplication error (A40113)	<ul style="list-style-type: none"> <li>• Expansion Rack number duplication (A410)</li> <li>• CPU Bus Unit number duplication (A411 to A416)</li> <li>• Special I/O Unit number duplication (A409)</li> </ul>
	Display section fatal error (A40112)	---
	Too many I/O points error (A40111)	<ul style="list-style-type: none"> <li>• Number of I/O points exceeds the CPU's maximum capacity (Bits A40713 to A40715 contain 000.)</li> <li>• Too many interrupt input points (Bits A40713 to A40715 contain 001.)</li> <li>• Too many Expansion Racks (Bits A40713 to A40715 contain 101.)</li> <li>• Unrecognized I/O Unit (Bits A40713 to A40715 contain 111.)</li> </ul>
	I/O setting error (A40110)	---
	Program error (A40109, A298 to A299)	<ul style="list-style-type: none"> <li>• Instruction processing error (A29508)</li> <li>• Indirect DM/EM BCD error (A29509)</li> <li>• Illegal access error (A29510)</li> <li>• No END error (A29511)</li> <li>• Task error (A29512)</li> <li>• Differentiation overflow error (A29513)</li> <li>• Illegal instruction error (A29514)</li> <li>• UM overflow error (A29515)</li> </ul>
	Cycle time overrun error	<ul style="list-style-type: none"> <li>• Cycle time too long (A40108)</li> <li>• Peripheral servicing time too long (A40515)</li> </ul>
System FALS error (A40106)	FALS number 0001 to 0511	

Error type	Error name	Error details
Non-fatal error (A39501)	System FAL error (A40215)	FAL number 0001 to 0511
	Interrupt task error (A40213)	Duplicate refreshing of a Unit's I/O
	Basic I/O error (A40212)	---
	PLC Setup error (A40210)	---
	I/O verification error	---
	Inner Board non-fatal error (A40208)	---
	CPU Bus error (A40207)	---
	Special I/O Unit error (A40206)	---
	Battery error (A40204)	---
	CPU Bus Unit Setup error (A40203)	---
	Special I/O Unit Setup error (A40208)	---
Other error	Output OFF bit (A50015)	---
	Communications error	Built-in RS-232C port (port C) communications error (A39204)

**Note** The addresses in parentheses are related flags and words in the Controller Section's Auxiliary Area.

**Errors Shown in the DeviceNet Troubleshooter**

The NSJ Troubleshooter displays the following errors that can occur in the built-in DeviceNet Unit.

Error type	Error name	Error details
Unit status	Unit error (n + 10 00)	An error occurred in operation as a DeviceNet Unit.
	Unit memory error (n + 10 04)	---
	Bus Off Detected error (n + 10 05)	---
	Node address duplication error (n + 10 06)	---
	Network power supply error (n + 10 07)	---
	Transmission timeout error (n + 10 08)	---
	Routing table error (n + 10 12)	---
	Message monitoring timer list logic error (n + 10 13)	---
	File read/write error (n + 11 08)	---



Error type	Error name	Error details
Master function status	Master function error (n + 10 01)	Verification error (n + 12 00)
		Configuration (structure) error (n + 12 01)
		Remote I/O communications error (n + 12 02)
		Scan list logic error (n + 12 04)
		Master function I/O refreshing error (n + 12 05)
	Master function enable/stop failure (n + 12 08)	---
	Master user-set allocation setting failure (n + 12 09)	---
	Master fixed allocation setting failure (n + 12 10)	---
	Scan list registration/clear failure (n + 12 11)	---
	Communication cycle time setting failure (n + 12 12)	---
	Slave status details (node 0 to node 63, words m+43 to m+74) See note 2.	Slave Error Flag (bit 00 or 08)
		Slave Verification Error Flag (bit 01 or 09)
		Slave Configuration Error Flag (bit 02 or 10)
Slave Remote I/O Communications Error Flag (bit 03 or 11)		
Master Function COS Send Failed Flag (bit 05 or 13)		
Slave function status	Slave function error (n + 10 03)	Remote I/O communications error, OUT1/IN1 (n + 14 02)
		Remote I/O communications error, OUT2/IN2 (n + 14 03)
		Slave function settings logic error (n + 14 04)
		Slave function I/O refreshing error (n + 14 05)
	Slave function enable/stop failure (n + 14 08)	---
	Slave user-set allocation setting failure (n + 14 09)	---
	Slave fixed allocation setting failure (n + 14 10)	---
	Slave function COS send failure (n + 14 11)	---

**Note** (1) The word addresses in parentheses indicate the offset from the beginning of the Unit's allocated CIO words (n) or the beginning of the Unit's allocated DM words (m).  
n = CIO 1500 + (25 × unit number)  
m = D30000 + (100 × unit number)

(2) Each node address is allocated 8 bits for the Slave status details.

Word	Bit 15	Bit 08	Bit 07	Bit 00
m + 43	Slave status details for node 1			Slave status details for node 0
m + 44	Slave status details for node 3			Slave status details for node 2
:				:
m + 74	Slave status details for node 63			Slave status details for node 62

### Starting NSJ Troubleshooter Screens with Alarms/Events

#### Alarm/Event Function

The Alarm/Event Function monitors the status of a bit in the host and displays a message or warning to the user when that bit goes ON. This function can be used to record events such as errors or the start of operation.

The main feature of the Alarm/Event Summary Function (current alarm display) is its ability to receive alarm/event notifications and track related information, such as the message set for the alarm/event, the time that the alarm/event occurred, and the time that the alarm/event was cleared.

The Alarm/Event History Function (alarm history display) lists past or present alarms/events as well as the message set for the alarm/event, the time that the alarm/event occurred, and the time that the alarm/event was cleared.

In addition to checking the Alarm/Event History from the NSJ Controller's System Menu, both the Alarm/Event History and Summary can be checked during operation from an object set in the screen. Also, the Alarm/Event History recorded in the NSJ Controller can be converted to a CSV file and saved in the Memory Card by turning ON System Memory bit \$SB33.

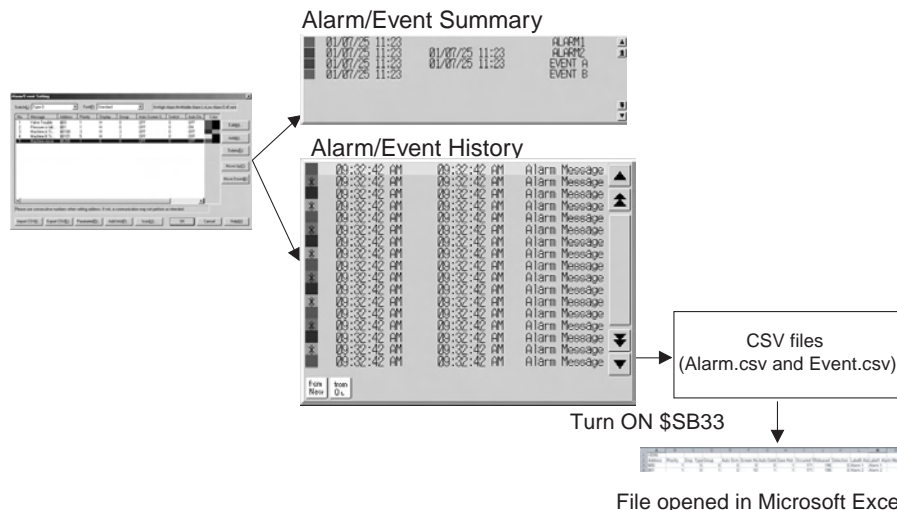

NSJ Troubleshooter Screens can be registered in this Alarm/Event History Function, so the Alarm/Event History Function can also manage errors that occur in the Controller Section or built-in DeviceNet Unit.

**Registering Alarms and Events**

Use the following procedure to register alarms and events.

1,2,3...

1. Select **Alarm/Event** from the CX-Designer's PT Menu. The Alarm/Event Details Window will be displayed.

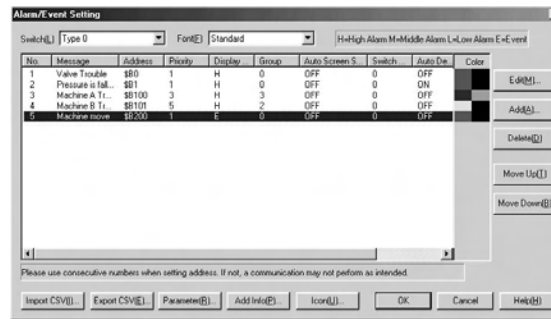

2. Click the **Add** Button. The Alarm/Event Details Window will be displayed.

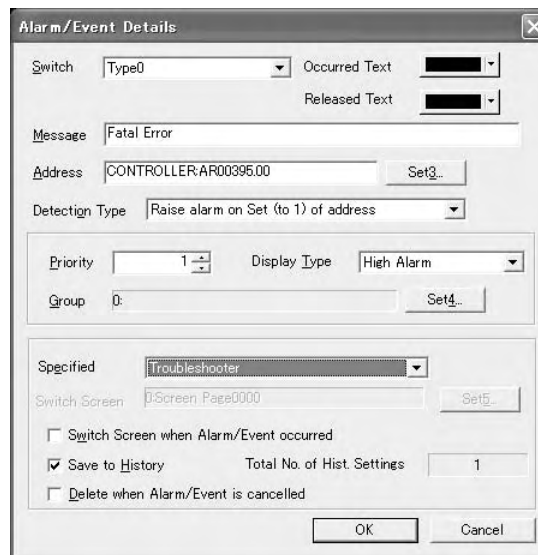

Input the bit address of a bit that indicates an alarm or event in the **Address** Field and click the **Set** Button. For example, input the bit address of an Auxiliary Area error flag in the Controller Section, which indicates that an error has occurred.

Example: A39500 (Fatal Error Flag) or A39501 (Non-fatal Error Flag)  
 Select *Troubleshooter* in the *Switch Destination* Pulldown List and click the **OK** Button.

3. If all of the settings have been completed, click the **OK** Button.  
 For details on other settings and Alarm/Event Functions, refer to 2-13 *Alarms and Events* and 3-7 *Using Alarm/Event Summary History Functions* in the *NS Series Programming Manual (V073)*.

## Starting NSJ Troubleshooter Screens with Command Buttons

### Registering Command Buttons

Use the following procedure to register Command Buttons.

- 1,2,3...
1. Select **Functional Object - Command Button** or click the  Icon in NS-Designer to create a Command Button.
  2. Right-click the created Command Button and select **Command Button** from the pop-up menu. The Command Button's *Functional Object Properties* Dialog Box will be displayed.
  3. In the General Tab Page, select *Display System Menu* in the *Function* Field and *Display Troubleshooter* in the *Switch Destination* Field.

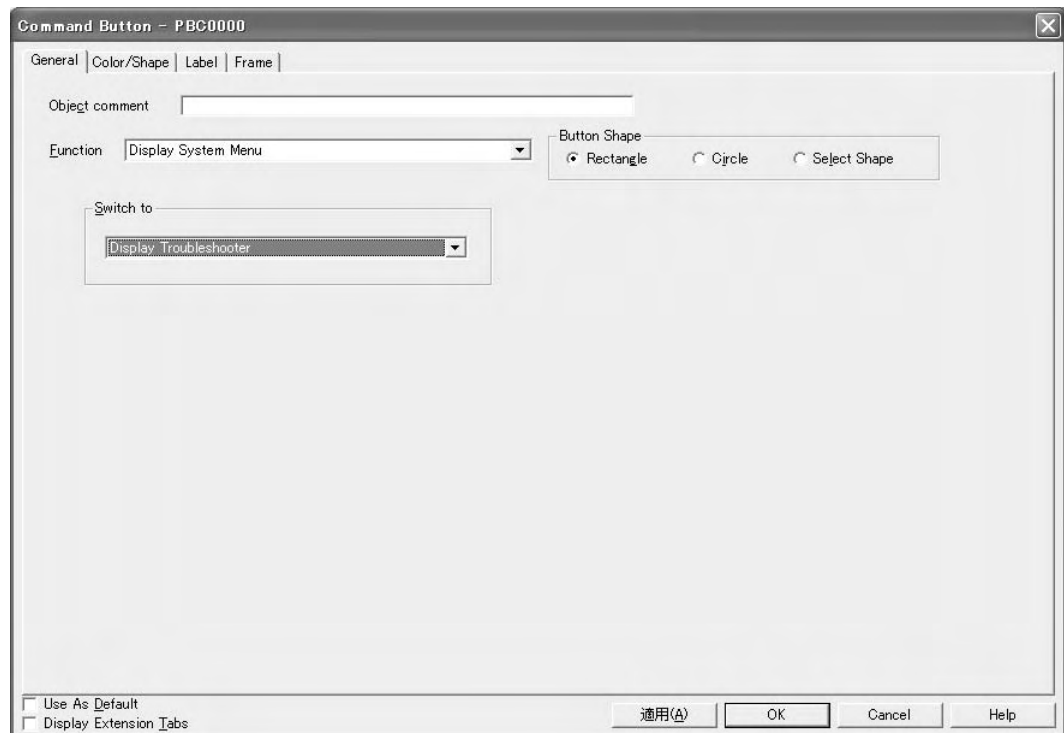

4. If all of the settings have been completed, click the **OK** Button.  
For details on other settings, refer to 2-9-3 *Command Buttons* in the *NS Series Programming Manual (V073)*.

# SECTION 11

## Maintenance and Inspections

.This section provides inspection and maintenance information.

11-1 Backup Function . . . . .	198
11-1-1 Data Backup Operations from the System Menu . . . . .	198
11-2 Inspections and Cleaning . . . . .	204
11-2-1 Inspection Points. . . . .	204
11-2-2 Cleaning . . . . .	206
11-2-3 Precautions when Replace the NSJ Controller or Units . . . . .	206
11-3 Maintenance and Replacement Methods . . . . .	207
11-3-1 Backlight. . . . .	207
11-3-2 Battery Replacement. . . . .	207

## 11-1 Backup Function

### 11-1-1 Data Backup Operations from the System Menu

Data in the NSJ Controller can be backed up from the System Menu.

Section	User data	Transfer method	Operating method	
			System Menu	DIP switch
Controller Section	<ul style="list-style-type: none"> <li>• User program</li> <li>• Parameter area</li> <li>• I/O memory</li> <li>• Conversion tables (See note 1.)</li> <li>• Comment file (See note 1.)</li> <li>• Program index file (See note 1.)</li> </ul>	Writing to Memory Card	Yes	Yes
		Reading from Memory Card (See note 2.)	No	Yes
		Verification with Memory Card	Yes	Yes
Display Section	<ul style="list-style-type: none"> <li>• Entire project</li> <li>• System program</li> </ul>	Uploading from NSJ Controller to Memory Card	Yes	Yes
		Downloading from Memory Card to NSJ Controller.	Yes	Yes

- Note**
- (1) Automatically created from one of the following: Memory Card, EM file memory, or comment memory.
  - (2) Data cannot be transferred from the Memory Card to the Controller Section using the System Menu. Use the DIP switch and Memory Card Power Button (MCPWR). Refer to 5-2-6 *Simple Backup Function* in the *CS/CJ Series PLC Programming Manual (W394)* for the procedure.

NSJ Controller data is transferred separately for the Controller Section and the Display Section. When backing up data to the Memory Card or restoring data from the Memory Card for the entire NSJ Controller, perform the backup/restore procedure for both the Controller Section and the Display Section.

It is also possible to back up or restore data for only the Controller Section or the Display Section. For example, data in the Controller Section will not be changed even if backup data is restored to the Display Section from a Memory Card.

- Note** Never turn OFF the power supply to the NSJ Controller or attempt to remove the Memory Card while the Memory Card is being accessed.

### Procedure

- 1,2,3... 1. Simultaneously press two of the four corners of the touch panel. The System Menu will be displayed.



2. Press the **Special Screen** Button. With the NSJ5, press the Right or Left Arrow Button until the Special Screen (2/2) is displayed.



3. Select **Memory Card Transfer** and then press the **Start** Button. A screen will be displayed to select the data to transfer.

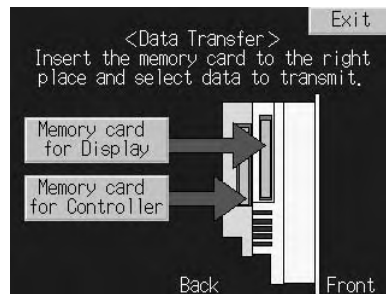

**Backing Up Controller Section Data to a Memory Card**

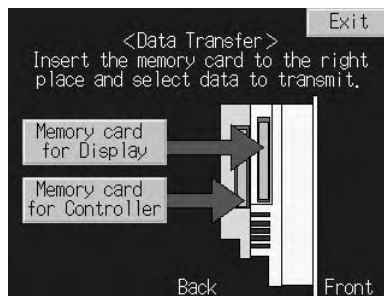

- 1,2,3...**
1. Insert a Memory Card into the Memory Card slot in the Controller Section (MC (CONTROLLER)) and then press the **Memory card for Controller** Button. A screen will be displayed to select the operation to be performed.



2. Press the **Backup** Button to back up the Controller Section data, and then press the **OK** Button on the confirmation display.



3. When the backup operation has been completed, remove the Memory Card and press the **OK** Button.

**Note** Never turn OFF the power supply to the NSJ Controller or attempt to remove the Memory Card while data is being transferred.

**Verifying Controller Section Data with a Memory Card**

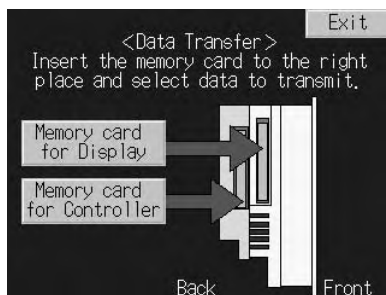

- 1,2,3...**
1. Insert a Memory Card into the Memory Card slot in the Controller Section (MC (CONTROLLER)) and then press the **Memory card for Controller** Button. A screen will be displayed to select the operation to be performed.





2. Press the **Verify** Button to verify the Controller Section data against the data on the Memory Card, and then press the **OK** Button on the confirmation display.



3. When the verification operation has been completed, remove the Memory Card and press the **OK** Button.

**Note** Never turn OFF the power supply to the NSJ Controller or attempt to remove the Memory Card while data is being transferred.

### Restoring Controller Section Data from a Memory Card

Data cannot be transferred from the Memory Card to the Controller Section using the System Menu. Use the DIP switch and Memory Card Power Button (MCPWR). Refer to 5-2-6 *Simple Backup Function* in the *CS/CJ Series PLC Programming Manual (W394)* for the procedure.

### Backing Up Display Section Data to a Memory Card

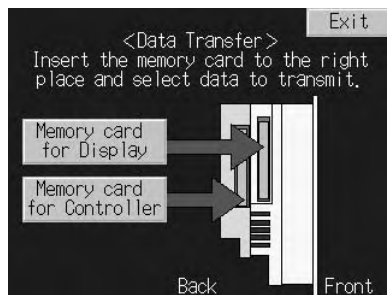

- 1,2,3...**
1. Insert a Memory Card into the Memory Card slot in the Display Section (MC (DISPLAY)) and then press the **Memory card for Display** Button. A screen will be displayed to select the operation to be performed.
  2. Select the transfer direction, contents, and bank. The IPP file name and system version stored in the specified Memory Card bank and in the NSJ Controller will be displayed for the project file names and system versions. Check this information and then press the **Go!** Button.

Item	Selection
Transfer direction	Upload
Transferred contents	Entire project
Bank	1 to 4

3. A message to confirm the transfer will be displayed. Press the **OK** Button to start the transfer. Warning messages will be displayed if the mode, system program version, screen data version, or language are not the same between the data in the NSJ Controller and the Memory Card. Press **OK** to continue with the transfer.

4. The indicator on the front of the Display Section will flash green when the transfer has been completed. To continue without removing the Memory Card, press the **Reset** Button. If the Memory Card is to be removed, remove it before pressing the **Reset** Button.

**Note** Only the Display Section will be reset when the **Reset** Button is pressed after transferring this data. The Controller Section will not be reset.

**Restoring Display Section Data from a Memory Card**

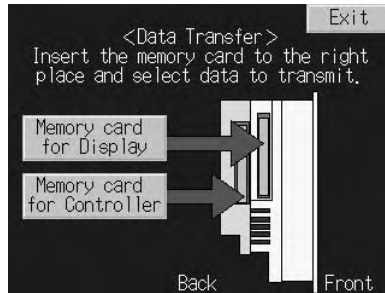

- 1,2,3...**
1. Insert a Memory Card into the Memory Card slot in the Display Section (MC (DISPLAY)) and then press the **Memory card for Display** Button. A screen will be displayed to select the operation to be performed.
  2. Select the transfer direction, contents, and bank. The IPP file name and system version stored in the specified Memory Card bank and in the NSJ Controller will be displayed for the project file names and system versions. Check this information and then press the **Go!** Button.

Item	Selection	Remarks
Transfer direction	Download	---
Transferred contents	Entire project	---
Bank	1 to 4	Specify the bank containing the data to be transferred.

3. A message to confirm the transfer will be displayed. Press the **Yes** Button to start the transfer. Warning messages will be displayed if the mode, system program version, screen data version, or language are not the same between the data in the NSJ Controller and the Memory Card. Press **Yes** to continue with the transfer.
4. The indicator on the front of the Display Section will flash green when the transfer has been completed. To continue without removing the Memory Card, press the **Reset** Button. If the Memory Card is to be removed, remove it before pressing the **Reset** Button.

**Note** Only the Display Section will be reset when the **Reset** Button is pressed after transferring this data. The Controller Section will not be reset.

**Auxiliary Area Bits  
and Words**

Name	Address	Description
Verification Mismatch Flag	A34312	Turns ON if there are any differences in the data being verified. Remains OFF if the data is the same.
File Memory Operation Flag	A34313	Turns ON while any of the following operations is being executed. OFF when none of them are being executed. Memory Card detection starting. CMND instruction sending a FINS command to the local CPU. FREAD/FWRIT instructions executing. Program replacement using the control bit in the Auxiliary Area. Simple backup operation. If this flag is ON, write and comparison operations to the Memory Card cannot be executed.
EM File Memory Starting Bank	A344	Contains the starting bank number of EM file memory (bank number of the first formatted bank). This number is read when starting to write data from a Memory Card. If the largest bank number for which there is an EM file for simple backup (BACKUPE□.IOM, where □ represents consecutive bank numbers starting from 0) is the same as the largest bank number supported, the EM Area will be formatted as file memory using the value in A344. If the maximum bank numbers are different, the EM Area will be returned to its unformatted (not file memory) status.
Communications Port Enabled Flags	A20200 to A20207	<ul style="list-style-type: none"> <li>• OFF while performing a write or verification operation for a Memory Card.</li> <li>• Turn ON when the write or verification operation has been completed.</li> </ul> <p><b>Note</b> If all of the Communications Port Enabled Flags remain OFF when a write or verification operation for a Memory Card, the write or verification operation was not executed (i.e., an error occurred).</p>
Communications Port Completion Codes	A203 to A210	Stores the result of communications with the Unit/Board when executing a write or verification operation for a Memory Card.
Communications Port Error Flags	A21900 to A21907	<ul style="list-style-type: none"> <li>• Turns ON if an error occurred in communications with the Unit/Board when executing a write or verification operation for a Memory Card.</li> <li>• Turns OFF if communications with the Unit/Board were normal when executing a write or verification operation for a Memory Card.</li> </ul>
Simple Backup Write Capacity	A397	If a write for a simple backup operation fails, A397 will contain the Memory Card capacity that would have been required to complete the write operation. The value is in Kbytes. (This indicates that the Memory Card did not have the specified capacity when the write operation was started.) 0001 to FFFF hex: Write error (value indicates required capacity from 1 to 65,535 Kbytes). A397 will be cleared to 0000 hex when the write is completed successfully for a simple backup operation. 0000 hex: Write completed normally.

**Note** The communications ports are related to these operation because when a simple backup operation is performed for the NSJ Controller to execute a write or verification operation for a Memory Card, the NSJ Controller will automatically use an available communications port number.

## 11-2 Inspections and Cleaning

Daily or periodic inspections and cleaning are required in order to maintain the NSJ Controller in peak operating condition.

### 11-2-1 Inspection Points

Although the major components in NSJ Controller have an extremely long life time, they can deteriorate under improper environmental conditions. Periodic inspections are thus required to ensure that the required conditions are being kept.

Inspection is recommended at least once every six months to a year, but more frequent inspections will be necessary in adverse environments.

Take immediate steps to correct the situation if any of the conditions in the following table are not met.

No.	Item	Inspection	Criteria	Action
1	Source Power Supply	Check for voltage fluctuations at the power supply terminals.	The voltage must be within the allowable voltage fluctuation range. (See note.)	Use a voltage tester to check the power supply at the terminals. Take necessary steps to bring voltage fluctuations within limits.
2	I/O Power Supply (for CJ-series Expansion Racks)	Check for voltage fluctuations at the I/O terminals.	Voltages must be within specifications for each Unit.	Use a voltage tester to check the power supply at the terminals. Take necessary steps to bring voltage fluctuations within limits.
3	Ambient environment	Check the ambient temperature (inside the control panel).	0 to 50°C Refer to 3-1-1 <i>General Specifications</i> .	Use a thermometer to check the temperature and ensure that the ambient temperature remains within the allowed range of 0 to 50°C.
		Check the ambient humidity (inside the control panel).	Relative humidity must be 35% to 85% with no condensation. Refer to 3-1-1 <i>General Specifications</i> .	Use a hygrometer to check the humidity and ensure that the ambient humidity remains within the allowed range. Check for the possibility of condensation occurring due to rapid changes in temperature.
		Check that the NSJ Controller is not in direct sunlight.	Not in direct sunlight	Protect the NSJ Controller if necessary.
		Check for accumulation of dirt, dust, salt, metal filings, etc.	No accumulation	Clean and protect the NSJ Controller if necessary.
		Check for water, oil, or chemical sprays hitting the NSJ Controller.	No spray on the NSJ Controller	Clean and protect the NSJ Controller if necessary.
		Check for corrosive or flammable gases in the area of the NSJ Controller.	No corrosive or flammable gases	Check by smell or use a sensor.
		Check the level of vibration or shock.	Vibration and shock must be within specifications.	Install cushioning or shock absorbing equipment if necessary.
		Check for noise sources near the NSJ Controller.	No significant noise sources	Either separate the NSJ Controller and noise source or protect the NSJ Controller.

No.	Item	Inspection	Criteria	Action
4	Installation and wiring	Check for loose mounting fixtures.	No looseness	Tighten loose screws with a Phillips screwdriver.
		Check that cable connectors are fully inserted and locked.	No looseness	Correct any improperly installed connectors.
		Check for loose screws in external wiring.	No looseness	Tighten loose screws with a Phillips screwdriver.
		Check crimp connectors in external wiring.	Adequate spacing between connectors	Check visually and adjust if necessary.
		Check for damaged external wiring cables.	No damage	Check visually and replace cables if necessary.
		Check that each Unit is connected and locked to the next Unit securely.	No looseness	Press the connectors together completely and lock them with the sliders.
5	User-serviceable parts	Check the brightness of the Backlight.	Must be sufficiently bright. Backlight service life expectancy is 50.000 h at 25°C	---
		Check whether the battery has reached its service life. CJ1W-BAT01	Service life expectancy is 5 years at 25°C, less at higher temperatures. Actual life is 0.75 to 5 years depending on model of NSJ Controller and ambient temperature.	Replace the battery when its service life has passed even if a battery error has not occurred. (Battery life depends upon the model of NSJ Controller and ambient temperature.)

**Note** The following tables show the allowable voltage fluctuation ranges for source power supplies.

**NSJ Controller Power Supply Terminals**

Item	Value
Supply voltage	24 V DC
Allowable voltage range	20.4 to 27.6 V DC (24 V DC±15%)

**CJ-series Expansion Racks**

Power Supply Unit	Supply voltage	Allowable voltage range
CJ1W-PA205R/PA205C	100 to 240 V AC	85 to 264 V AC (+10%/-15%)
CJ1W-PA202		
CJ1W-PD025	24 V DC	19.2 to 28.8 V DC (±20%)
CJ1W-PD022		21.6 to 26.4 V DC (±10%)

**Tools Required for Inspections**

**Required Tools**

- Phillips screwdrivers
- Voltage tester or digital voltmeter
- Industrial alcohol and clean cotton cloth

**Tools Required Occasionally**

- Synchroscope
- Oscilloscope with pen plotter
- Thermometer and hygrometer (humidity meter)

## 11-2-2 Cleaning

Clean and inspect the Display Section periodically to maintain it in optimum condition for use. The screen visibility will be impaired if the display becomes dirty. Clean the display periodically using the following methods:

- For daily cleaning, wipe with a soft, dry cloth. Attempting to remove heavy dirt with the dry cloth may scratch the front panel sheet. Use a damp cloth first to remove dirt and then wipe the surface again with the dry cloth.
- If dirt cannot be removed using a dry cloth, dampen the cloth sufficiently with a neutral cleaning agent solution (approximately 2%), squeeze the cloth out, and then wipe the surface.
- Materials such as rubber, vinyl, or tape that are attached to the Unit will leave stains if left for a long time. If such material is attached to the Unit, remove when cleaning.

**Note** Never use benzene, thinner, or other volatile solvents, or chemical cloths to clean the NSJ Controller.

## 11-2-3 Precautions when Replace the NSJ Controller or Units

Always observe the following precautions when faults are detected during inspection and the NSJ Controller or Units are to be replaced.

- Always turn OFF the power to the NSJ Controller or Expansion Rack before replacing the NSJ Controller or CJ-series Units.
- After replacing the NSJ Controller or a CJ-series Unit, check to confirm that the new NSJ Controller or CJ-series Unit has no faults.
- When returning a faulty NSJ Controller or CJ-series Unit for repair, include a document that provides as many details on the fault as possible, and send to your OMRON representative.
- If there is a poor contact, use industrial-grade alcohol soaked into a cotton cloth and then remove any threads before mounting the NSJ Controller or CJ-series Unit.

- Note**
- (1) When replacing the NSJ Controller, start operation with the new NSJ Controller only have loading or setting the user program, data memory, Holding Area data, and all other data required for operation. Unexpected operation may occur if the data memory, Holding Area data, or other data, and the program are not correct in relation to each other.
  - (2) Routing tables, Controller Link Unit data link tables, network parameters, and other settings for CPU Bus Units are stored in the Parameter Area of the NSJ Controller. Be sure to transfer to set this data when replacing the NSJ Controller.
  - (3) When replacing a CPU Bus Unit or Special I/O Unit, refer to the operation manual for the Unit and make all required settings.
  - (4) Always keep a backup of the project data for the Display Section. This is particularly important when requesting repairs from OMRON, during which the project data may be deleted.
  - (5) If the simple backup operation is used, backup files of all programs and parameters for the NSJ Controller, DeviceNet Units, Serial Communications Units, and other Unit will be stored on the Memory Card. This backup data can be restored after replacing a Unit to simplify resetting Units after replacement. For information on the Units that are backed up by the simple backup operation, refer to *Applicable Units and Boards* under 5-2-

6 Simple Backup Function in the CS/CJ Series PLC Programming Manual (W394).

## 11-3 Maintenance and Replacement Methods

The NSJ Controller has the following replaceable parts:

Backlight

Battery (backs up the clock and RAM in the NSJ Controller)

### 11-3-1 Backlight

The backlight must be replaced when the brightness of the display backlight dims and the display becomes difficult to see. The backlight cannot be replaced by the user. Contact your nearest OMRON representative.

#### Backlight Replacement Guidelines

Replace the backlight according to the following guidelines under normal conditions.

After 50,000 hours of use at room temperature and humidity, or after approximately 40,000 hours if an NSJ8 is used.

The NSJ8, NSJ10, and NSJ12 use a CCFL (cold cathode fluorescent lamp) for the backlight. The life of a CCFL is affected by the environment and is particularly affected by cold environments. If the backlight become darker, making it difficult to see the screen, replace the backlight. The NSJ5 uses LEDs for the backlight. The life of a LED is affected by the environment and is particularly affected by hot environments. If the backlight become darker, making it difficult to see the screen, replace the backlight.

### 11-3-2 Battery Replacement

#### Battery Functions

The battery maintains the internal clock and the following data in RAM while the main power supply is OFF.

- PLC Setup
- Retained regions of I/O memory

If the battery is not installed or the battery voltage drops too low, the internal clock will stop and the data in RAM will be lost when the main power supply is turned OFF.

#### Battery Service Life and Replacement Period

At 25°C, the maximum service life for the battery is five years whether or not power is supplied to the NSJ Controller while the battery is installed. The battery's lifetime will be shorter when it is used at higher temperatures.

The following table shows the approximate minimum lifetimes and typical lifetimes for the backup battery (total time with power not supplied).

Model	Approx. maximum lifetime	Approx. minimum lifetime (See note.)	Typical lifetime (See note.)
NSJ Controller	5 years	12,600 hours (1.46 years)	43,000 hours (5 years)

**Note** The minimum lifetime is the memory backup time at an ambient temperature of 55°C. The typical lifetime is the memory backup time at an ambient temperature of 25°C.

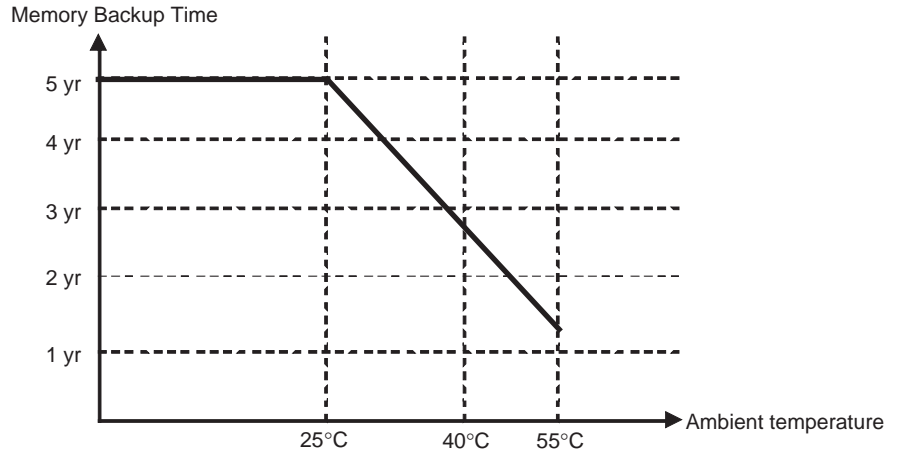

This graphic is for reference only.

**Low Battery Indicators**

If the ERR/ALM indicator flashes and the RUN indicator on the Display Section flashes red, use one of the following methods to see if a low battery voltage has been detected.

1,2,3...

1. Connect the CX-Programmer, go online, and double-click **Error Log** in the Project Workspace. Then check for a battery error (non-fatal error) in the NSJ Controller errors.
2. Press two of the four corners of the Display Section to display the System Menu. Press the **Special Screen** Tab, start the Troubleshooter, and select the NSJ Troubleshooter. A battery error (non-fatal error) will be displayed in reverse video if a low battery voltage has been detected.

If a battery error has occurred, first check the battery connector to see if the battery is connected properly. If the battery connection is okay, replace the battery as soon as possible.

Once a low-battery error has been detected, it will take 5 days at room temperature before the battery fails assuming that power has been supplied at least once a day. (See note.) Battery failure and the resulting loss of data in RAM can be delayed by ensuring that the NSJ Controller's power is not turned OFF until the battery has been replaced.

**Note** The battery will discharge faster at higher temperatures, e.g., 4 days at 40°C and 2 days at 55°C.

**Replacement Battery**

Use the CJ1W-BAT01 Battery Set.

**Note** Be sure to install a replacement battery within two years of the production date shown on the battery's label. The production date is read as follows:

Production Date



Manufactured in June 2002.



**Replacement Procedure**

Use the following procedure to replace the battery. You must complete this procedure within five minutes after turning OFF the power to the NSJ Controller to ensure memory backup.

The direction of the battery connector depends on the model of the NSJ Controller.

- 1,2,3...**
1. Turn ON the power supply to the NSJ Controller for at least five minutes and then turn it OFF.
  2. Open the battery compartment on the back of the NSJ Controller.
  3. Carefully remove the battery from the battery holder, hold onto the cable, and pull straight out to disconnect the connector.

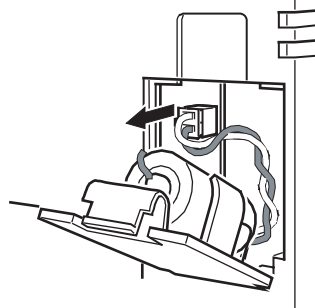

4. Connect the new battery and place the battery into the battery holder on the battery compartment cover.

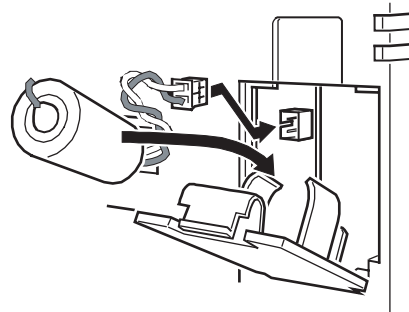

5. Close the cover to the battery compartment, being careful not to pinch the battery cable.



# Appendix A

## Replacing the System Program

The system program in the Display Section can be replaced or upgraded to a higher version by using a Memory Card and the DIP switch. There are two methods that can be used to replace the system program.

- Using a recovery/upgrade program
- Transferring system program data

This function replaces or upgrades the system program in the Display Section only. It does not affect the system program in the Controller Section.

**Note** If the system program is not replaced correctly, the NSJ Controller may fail to start. Observe the following precautions.

- Always use a recovery/upgrade program when upgrading (or downgrading) the system program.
- The system program must be version 8.0 or higher to be installed in the NSJ5-□Q1□-□□□. Consult your OMRON representative if a system program of a version lower than 8.0 is to be installed.
- To replace the system program in the NSJ5-□Q0□-□□□ or NSJ8/10/12-□□□□-□□□, system program version 6.5 or higher must be used. If an earlier version is used, screens may not be displayed properly. If an earlier version is installed by mistake, use a recovery/upgrade program to upgrade to version 6.5 or higher.

### Using a Recovery/Upgrade Program

Use the following procedure to replace the system program if the system program becomes corrupted and the Display Section will not start or to upgrade the system program in the Display section.

1. Copy all of the files and folders in the RecoverUpdate\_6\_5 NSJ-HSH folder inside the CX-Designer installation folder (default: C:\ProgramFiles\Omron\CX-One\CX-Designer) to a Memory Card. This program can be selected when installing the CX-Designer.
2. Insert the Memory Card into the Memory Card slot in the Display Section (MC (DISPLAY)) and turn ON the power supply. The recovery/update program will start automatically.

**Note** (1) Always use the data in the RecoverUpdate\_6\_5 NSJ-HSH folder when performing a recovery/update operation (6\_5 indicates version 6.5). Do not use a version lower than 6.5.  
(2) For details on the procedure to replace the system program using the recovery/update program, select **Start - Program - OMRON - CX-One - CX-Designer - How to recover the system prog Ver. 6.5**.

### Transferring System Program Data

When System Program Ver. 6.5 is selected and loaded with the CX-Designer, it is stored under the CX-Designer's install folder (default location is C:\Program Files\Omron\CX-One\CX-Designer) in folders that are created for each type and version, as follows:

```
\SystemBackup\NSJ12\V6_5\bank1:Ver. 6.5 for NSJ12
  \NSJ10\V6_5\bank1:Ver. 6.5 for NSJ10
  \NJS8\V6_5\bank1:Ver. 6.5 for NSJ8
  \NSJ5\V6_5\bank1:Ver. 6.5 for NSJ5
```

To replace a system program, use Windows Explorer or another method to copy each of the folders for the required system program under \bank1 to the route directory of the Memory Card.

## Transferring Data

Use the DIP switch on the rear panel of the NSJ Controller to set the operating mode for data transfer to automatic download (transfers data from the Memory Card to the NSJ Controller), automatic upload (transfers data from the NSJ Controller to the Memory Card), or manual transfer (user selects whether to download or upload). Data can be transferred with the Memory Card when the Display Section is started up.

- Note**
- (1) Before transferring data, check that the system programs and screen data types match those in the Display Section.
  - (2) Always reset the Display Section or turn ON the power again after changing the DIP switch setting.
  - (3) Do not perform the following operations while the Memory Card is being accessed. The data may be damaged and the Memory Card may need to be formatted.
    - Turn OFF the power to the NSJ Controller.
    - Press the Display Section reset switch.
    - Remove the Memory Card.
  - (4) Always remove the Memory Card as described in the following procedures.

If the Display Section system is damaged due to the power being turned OFF while a file is being written, or other reason, using normal downloading to replace the system programs may not be possible. For details on troubleshooting, refer to *Errors* on page 216.

### DIP Switch (SW2)

The Memory Card can be divided into up to four areas, which are called banks.

The DIP switch on the rear panel of the NSJ Controller has six pins. The ON/OFF combination of these pins specifies which transfer method is used.

Pin No.	Function
1	Specifies bank 1 when transferring. (ON: Specifies bank 1.)
2	Specifies bank 2 when transferring. (ON: Specifies bank 2.)
3	Specifies bank 3 when transferring. (ON: Specifies bank 3.)
4	Specifies bank 4 when transferring. (ON: Specifies bank 4.)
5	Specifies upload or download. (ON: Upload, OFF: Download)
6	Specifies manual or automatic transfer. (ON: Manual, OFF: Automatic)

Banks are automatically created under the following conditions.

- When data is transferred to the Memory Card using the CX-Designer transfer program.
- When data is transferred (uploaded) from the NSJ Controller.

- Note**
- (1) When transferring data, only one bank can be specified. Set only one of pins 1 to 4 to ON.
  - (2) The NSJ Controller will operate normally when the DIP switch is set to a combination other than one specifying automatic upload, download, or manual transfer.
  - (3) When data has already been stored in the banks of the Memory Card and uploading is executed, the previous data in the specified bank will be deleted. Always check the data stored in the banks before uploading.
  - (4) If the \BANK□\DATA and \BANK□\SYSTEM are created manually in the Memory Card, and used for purposes other than transferring data, when uploading is performed, the data in the folders will be deleted, and the data in the Display Section will be copied to the folders. Therefore, do not use \BANK□\DATA or \BANK□\SYSTEM when creating folders in the Memory Card.
  - (5) Set all pins to OFF when using normal operation.

## Automatic Download

An automatic download transfers system programs and screen data from the Memory Card in the Display Section (MC (DISPLAY)) to the Display Section.

Set the DIP switch for automatic download, as shown below. The Memory Card cannot be used to transfer data when the DIP switch pins are set to combinations other than those specified here.

DIP switch pins and status						Operation
1	2	3	4	5	6	
ON						Automatically downloads bank 1 system programs and screen data.
	OFF	OFF	OFF	OFF	OFF	
	ON					Automatically downloads bank 2 system programs and screen data.
OFF		OFF	OFF	OFF	OFF	
		ON				Automatically downloads bank 3 system programs and screen data.
OFF	OFF		OFF	OFF	OFF	
			ON			Automatically downloads bank 4 system programs and screen data.
OFF	OFF	OFF		OFF	OFF	

Use the following procedure to automatically download data.

1. Turn OFF the power to the NSJ Controller.
2. Set the DIP switch.
3. Insert the Memory Card with the specified banks stored in it into the Display Section (MC (DISPLAY)).
4. Turn ON the power to the NSJ Controller.  
The system programs and screen data will be written to the Display Section.
5. The status of the NSJ Controller indicators during data transfer is as shown below.  
Do not remove the Memory Card during data transfer.  
Transferring data: Indicator flashes orange.  
Transferring completed: Indicator flashes green.  
Error occurred: Indicator flashes red.  
Refer to *Errors* on page 216 if an error occurs.
6. Turn OFF the power.
7. Remove the Memory Card.
8. Turn OFF all the DIP switch pins.
9. Turn ON the power.

A warning message will not be displayed when automatic download is executed even if the Display Section model, versions, and language for the system programs and screen data that are stored in the Display Section are different from those that are stored in the Memory Card.

Always check carefully that the Display Section model and Memory Card details match before transferring data automatically.

## Automatic Upload

An automatic upload transfers system programs and screen data from the Display Section to the Memory Card in the Display Section (MC (DISPLAY)).

Set the DIP switch for automatic upload, as shown below. The Memory Card cannot be used to transfer data when the DIP switch pins are set to combinations other than those specified here.

DIP switch pins and status						Operation
1	2	3	4	5	6	
ON				ON		Automatically uploads system programs and screen data to bank 1.
	OFF	OFF	OFF		OFF	
	ON			ON		Automatically uploads system programs and screen data to bank 2.
OFF		OFF	OFF		OFF	
		ON		ON		Automatically uploads system programs and screen data to bank 3.
OFF	OFF		OFF		OFF	
			ON	ON		Automatically uploads system programs and screen data to bank 4.
OFF	OFF	OFF			OFF	

Use the following procedure to automatically upload data.

1. Turn OFF the power to the NSJ Controller.
2. Set the DIP switch.
3. Insert the Memory Card into the Display Section (MC (DISPLAY)).
4. Turn ON the power to the NSJ Controller.  
The system programs and screen data will be written to the Memory Card.
5. The status of the NSJ Controller indicator during data transfer is as shown below.  
Do not remove the Memory Card during data transfer.  
Transferring data: Indicator flashes orange.  
Transferring completed: Indicator flashes green.  
Error occurred: Indicator flashes red.  
Refer to *Errors* on page 216 if an error occurs.
6. Turn OFF the power.
7. Remove the Memory Card.
8. Turn OFF all the DIP switch pins.
9. Turn ON the power.

A warning message will not be displayed when automatic upload is executed even if the Display Section model, versions, and language for the system programs and screen data that are stored in the Display Section are different from those that are stored in the Memory Card.

Always check carefully that the Display Section model and Memory Card details match before transferring data automatically.

## Manual Transfer

Use screen operations to select the direction (download or upload), contents (Project, Project & System, or System), and banks.

Use one of the following procedures to manually transfer data.

1. Turn OFF the power to the NSJ Controller, turn ON pin 6 of the DIP switch, and turn ON the power to the NSJ Controller.

DIP switch pin and status						Operation
1	2	3	4	5	6	
					ON	Enables manually downloading or uploading the system program and screen data.
OFF	OFF	OFF	OFF	OFF		

2. Execute *Memory Card Transfer* from the *Special Screen Tab Page* of the System Menu. Refer to *11-1 Backup Function* for details.

Use the following procedure to manually transfer data mentioned above in step 1.

1. Turn OFF the power to the NSJ Controller.
2. Turn ON pin 6 of the DIP switch.
3. Insert the Memory Card into the Display Section (MC (DISPLAY)).
4. Turn ON the power.
5. The following screen will be displayed on the Display Section.



6. Specify the direction, contents (project, project and system, or system), and bank.
7. The IPP file name and system version that are stored in both the specified bank of the Memory Card and the Display Section will be displayed in the Project File and System Version fields. After confirming the details, press the **Go** Button.
8. A message confirming the transfer will be displayed. Press the **OK** Button to execute the specified data transfer operation. When downloading, the screen data previously stored in the Display Section will be deleted.
9. A warning message will be displayed if the Display Section model, system program/screen data versions, and language for the data stored in the Display Section are different from that for the data stored in the Memory Card. Press the **Yes** Button to continue transferring the data.
10. The uploading/downloading screen will be displayed while data is being transferred. A screen indicating that the transfer has completed will be displayed when the transfer has finished. (If an error occurs, a transfer error screen will be displayed. Refer to *Errors* on page 216 if an error occurs.)
11. The indicator will flash green when transferring has finished.
12. Turn OFF pin 6 of the DIP switch and reset the Display section.

The system settings cannot be changed for the upload operation (i.e., the system settings set with the CX-Designer).

## Errors

### Errors during Automatic Transfer

The indicator on the front panel will flash red if an error occurs during data transfer. Check the following items if an error occurs.

- Is the Memory Card inserted into the slot in the Display Section (MC (DISPLAY))?
- Do the banks set with the DIP switch exist in the Memory Card (during download)?
- Is the size of the transfer data greater than the free space in the Display Section or Memory Card?  
Check these items before transferring data again.

**Note** An error message will not be displayed even if an error occurs.

### Errors during Manual Transfer

If an error occurs during data transfer, a transfer error screen will be displayed. Check the following items for the displayed message.

Error message	Check item
Memory Card Error Could not recognize a Memory Card. Check the Memory Card and reset the NS Hardware.	<ul style="list-style-type: none"> <li>• Is the Memory Card inserted into the slot in the Display Section (MC (DISPLAY))?</li> <li>• Is the Memory Card damaged?</li> </ul>
Project Transmission Error Transmission Failed. Check the Memory Card and reset the NS Hardware.	<ul style="list-style-type: none"> <li>• Was the Memory Card removed during data transfer?</li> <li>• Is there sufficient available space on the Memory Card?</li> <li>• Is the Memory Card damaged?·</li> </ul>
System Transmission Error Transmission Failed. Check the Memory Card and reset the NS Hardware.	<ul style="list-style-type: none"> <li>• Does the screen data volume exceed the memory capacity of the Display Section?</li> </ul>
Cannot find source data. Are you sure to continue Downloading/Uploading?	<ul style="list-style-type: none"> <li>• Does the transfer source directory or file exist? (Note: If the <b>Yes</b> Button is pressed and data is transferred, the previous data at the transfer destination will be deleted.)</li> </ul>

After checking the message, reset the Display Section, and transfer the data again.

## System Program Recovery/Update

It may not be possible to replace the system program using a normal download if the Display Section system has been damaged, e.g., if the power was turned OFF while a file was being written. Use the following procedure if system program replacement is not possible or the system program is damaged and the Display Section does not start.

1. Copy *Recover\_6\_5*. to a Memory Card. This program can be installed with CX-Designer Ver. 1.01 by specifying it in the setup wizard.
2. Place the Memory Card into the slot in the Display Section (MC (DISPLAY)) and turn ON the power. The recovery program will start automatically. Refer to the file *How to recover Ver. 6\_5.pdf* for details on recovery operations. This can be accessed from **Windows Start - Programs - Omron - CX-One - CX-Designer - How to recover the system prog Ver. 6.5**.
3. The system will start automatically downloading data to the Display Section.

The indicator will flash green when the download has finished.



# Appendix B

## System Memory List

System memory is used for exchanging information between the Controller Section and the Display Section, such as controlling the Display Section and notifying the Controller Section of Display Section status.

The system memory is divided into bit and word sections.

### System Bit Memory (\$SB)

System bit memory (\$SB) is used for exchanging information between the Controller Section and the Display Section in bit units, such as controlling the Display Section and notifying the Controller Section of Display Section status.

The system bit memory contains 53 bits with predefined functions. The system bit memory is listed in the following table.

Address	Classification	Function
\$SB0	Notification	RUN Signal (Pulse)
\$SB1	Notification	RUN Signal (Always ON)
\$SB2	Notification	Screen Switch Strobe
\$SB3	Control	Prohibit Shifting to System Menu
\$SB4	Notification	Battery Low
\$SB5	Notification	Data Input Detector
\$SB6	Control	Brightness Adjust, High
\$SB7	Control	Brightness Adjust, Medium
\$SB8	Control	Brightness Adjust, Low
\$SB9	Control	Backlight Control (screen saver control)
\$SB10	Control	Control Backlight Flashing
\$SB11	Notification	Backlight Status
\$SB12	Control	Continuous Buzzer
\$SB13	Control	Short Intermittent Buzzer
\$SB14	Control	Long Intermittent Buzzer
\$SB15	Notification/control	Notification/Control of Video Input
\$SB16	Control	Processing Priority Registration for Port A (NT Link 1:N)
\$SB17	Control	Processing Priority Registration for Port B (NT Link 1:N)
\$SB18	Control	Display Keypad with Temporary Input
\$SB19	Control	Prohibit input
\$SB20	Control	Contrast Adjustment (+10 levels) (NSJ5-SQ0 only)
\$SB21	Control	Contrast Adjustment (+1 level) (NSJ5-SQ0 only)
\$SB22	Control	Contrast Adjustment (-1 level) (NSJ5-SQ0 only)
\$SB23	Control	Contrast Adjustment (-10 levels) (NSJ5-SQ0 only)
\$SB24	Notification/control	Video Capture
\$SB25	Control	Starts Printing/Capture Screen (NSJ12/NSJ10/NSJ8 only)
\$SB26	Control	Stops Printing
\$SB27	Control	Test Pattern Printing
\$SB28	Control	Printer Head Cleaning
\$SB29	Control	Update Printer Status
\$SB30	Notification	Printer Busy Status
\$SB31	Notification	Notification of Printer Error
\$SB32	Notification/control	Initialize Alarm/Event History
\$SB33	Notification/control	Save Alarm/Event History

Address	Classification	Function
\$SB34	Notification/control	Internal Holding Memory (\$HB/\$HW) Initialization
\$SB35	Notification/control	Initialize Data Log
\$SB36	Notification/control	Save Data Log
\$SB37	Notification/control	Initialize Operation Log
\$SB38	Notification/control	Save Operation Log
\$SB39	Control	Log Functional Object Operation
\$SB40	Control	Log Switch Screen Operation
\$SB41	Control	Log Macro Operation
\$SB42	Notification/control	Initialize Error Log
\$SB43	Notification/control	Save Error Log
\$SB44	---	Reserved
\$SB45	Control	Macro Error Dialog Control
\$SB46	Notification	Notification of Macro Error
\$SB47	Notification	Logging Process or Video Capture Error Flag
\$SB48	Notification	Memory Card Free Space Check Flag
\$SB49	Notification/control	Stop Memory Card
\$SB50	Notification	Memory Card Removing Status
\$SB51	Notification	Periodical Data Log Save in Process Flag
\$SB52	Notification	Data Block Operation Complete Flag

**Note** The notification words are not write prohibited. In addition, the system will not restore values, except when the status has changed.

System memory is allocated to PLC areas (including the Controller Section) as shown below. Allocated addresses for System Memory using CX-Designer on the Initial Tab Page that appears when **PT - System Settings** is selected.

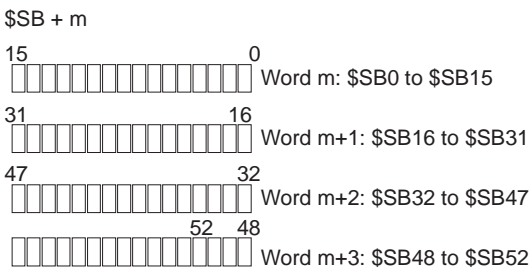

**System Word Memory (\$SW)**

System word memory (\$SW) is used for exchanging information between the Controller Section and the Display Section in word units, such as controlling the Display Section and notifying the Controller Section of Display Section status.

The system word memory contains 39 items with predefined functions. The system word memory is listed in the following table.

Address	Classification	Function
\$SW0	Notification/control	Current Screen Number
\$SW1	Notification/control	Display Pop-up Screen 1 Number
\$SW2	Notification/control	Pop-up Screen 1 Display Position (X Coordinate)
\$SW3	Notification/control	Pop-up Screen 1 Display Position (Y Coordinate)
\$SW4	Notification/control	Display Pop-up Screen 2 Number
\$SW5	Notification/control	Pop-up Screen 2 Display Position (X Coordinate)
\$SW6	Notification/control	Pop-up Screen 2 Display Position (Y Coordinate)
\$SW7	Notification/control	Display Pop-up Screen 3 Number

Address	Classification	Function
\$SW8	Notification/control	Pop-up Screen 3 Display Position (X Coordinate)
\$SW9	Notification/control	Pop-up Screen 3 Display Position (Y Coordinate)
\$SW10	Notification/control	Display Label Number
\$SW11	Control	Print Screen/Screen Capture
\$SW12	Control	Backlight Brightness Adjustment (1 to 32) (NSJ5-SQ1/-TQ1 only*1)
\$SW13	Control	Password Number For Input Prohibit Clear
\$SW14	Notification	Current Time (min, s)
\$SW15	Notification	Current Date and Time (day, hour)
\$SW16	Notification	Current Date (year, month)
\$SW17	Notification	Current Day (day of the week)
\$SW18	Notification	No. of Generated Alarms and Events
\$SW19	Notification	ID Number for Generated Alarms and Events
\$SW20	Notification	ID Number for Cleared Alarms and Events
\$SW21	Notification	Alarm/Event ID when Alarm/Event Object Macro Executed
\$SW22	---	Reserved
\$SW23	Notification	Macro Execution Error Number
\$SW24	Notification	Macro Error Screen Number
\$SW25	Notification	Macro Error Object ID Number
\$SW26	Notification	Error Macro Execution Timing
\$SW27	Control	Offset Value for Index I0
\$SW28	Control	Offset Value for Index I1
\$SW29	Control	Offset Value for Index I2
\$SW30	Control	Offset Value for Index I3
\$SW31	Control	Offset Value for Index I4
\$SW32	Control	Offset Value for Index I5
\$SW33	Control	Offset Value for Index I6
\$SW34	Control	Offset Value for Index I7
\$SW35	Control	Offset Value for Index I8
\$SW36	Control	Offset Value for Index I9
\$SW37	Notification/control	Data Log Group Number
\$SW38	Notification	Data Block Error Number

\*1 NSJ5-SQ1/-TQ1 with lot number 15Z0 or later only.

**Note** The notification words are not write prohibited. In addition, the system will not restore values, except when the status has changed.

System word memory is allocated to PLC areas (including the Controller Section) as shown below. Allocated addresses for System Memory using CX-Designer on the Initial Tab Page that appears when **PT - System Settings** is selected.

\$SW = n

Word n: \$SW0

Word n+1: \$SW1

Word n+38: SW38



# Appendix C

## NSJ-series Controller Lot Numbers

The four-digit lot numbers given on the back of NSJ-series Controllers can be used to check the manufacturing date.

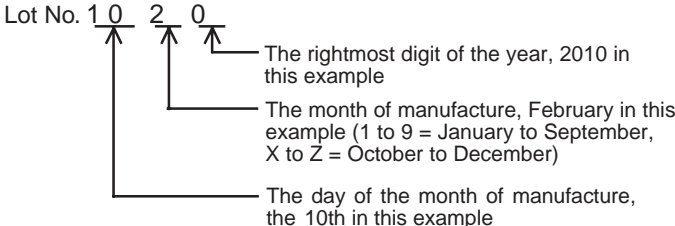



## Revision History

A manual revision code appears as a suffix to the catalog number on the front cover of the manual.

Cat. No. W452-E1-06

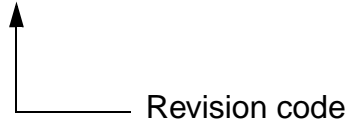

The following table outlines the changes made to the manual during each revision. Page numbers refer to the previous version.

Revision code	Date	Revised content
01	December 2005	Original production
02	July 2006	<b>Page vi:</b> Information added on CX-Programmer. <b>Page 3:</b> Information added on CX-One versions. <b>Page 4:</b> Information added on ladder monitoring function. <b>Page 5:</b> Information added on types of NSJ Controllers. <b>Page 13:</b> Information added on frame length. <b>Pages 19 and 20:</b> Information added on differences between NSJ Controllers and previous products. <b>Page 44:</b> Information added on connectable Units. <b>Page 61:</b> Information added on I/O capacity. <b>Page 64:</b> Information added on Support Software versions.
03	March 2008	<b>Page xi:</b> Changed versions of Support Software. <b>Pages xii and xiii:</b> Updated information in related manual table. <b>Page xxviii:</b> Changed figure. <b>Page xxx:</b> Added item to section 6-3. <b>Page 40:</b> Changed enclosure specification. <b>Page 93:</b> Removed line for Nichifu Terminal Industries Co., Ltd. from table. <b>Page 95:</b> Added information on Flat Cables. <b>Page 96:</b> Changed information on recommended crimp terminals and tools. <b>Page 103:</b> Removed last line of table.
04	May 2008	The model numbers were changed to indicate a variable portion throughout the manual. <b>Page vi:</b> Changed version information. <b>Page 114:</b> Changed address ranges. <b>Pages 44 and 45:</b> Added models to table in two locations on each page. <b>Page 47:</b> Added models to table.

## Revision History

Revision code	Date	Revised content
05	March 2010	<p><b>Page xi:</b> Corrected catalog numbers for Communications Command Reference Manual and CX-Designer Operation Manual. Removed version numbers from Support Software manual names.</p> <p><b>Page xii:</b> Updated version numbers in manual names. Corrected catalog number of Instructions Reference Manual in description of CX-Programmer Operation Manual. Corrected catalog number of CX-Designer Operation Manual.</p> <p><b>Page xxi:</b> Changed end of second paragraph.</p> <p><b>Pages 36, 37, and 150:</b> Corrected catalog number for CX-Designer Operation Manual.</p> <p><b>Pages 45 and 46:</b> Changed contents of table and added sentence at bottom of page.</p> <p><b>Page 82:</b> Changed the first sentence under <i>Touch Panel</i> and corrected model number.</p> <p><b>Page 128:</b> Corrected model number at bottom of second table.</p> <p><b>Page 142:</b> Corrected model number.</p> <p><b>Page 148:</b> Corrected model number at bottom of page.</p>
06	November 2010	<p><b>Page xxi:</b> Added three warnings.</p> <p><b>Page xxiii:</b> Added two lines to the first caution.</p> <p><b>Page xxiv:</b> Removed second paragraph with bullet, changed sentence starting "Use a DC power," and corrected unit for tightening torque.</p> <p><b>Page xxv:</b> Added sentence to fourth paragraph and added paragraph after eighth paragraph.</p> <p><b>Page xxvi:</b> Added paragraph after eighth paragraph.</p> <p><b>Page xxvii:</b> Added paragraph after fourth paragraph.</p> <p><b>Page xxviii:</b> Added paragraph after eighth paragraph.</p> <p><b>Page xxix:</b> Added paragraphs after third paragraph.</p> <p><b>Page 40:</b> Changed battery life specification.</p> <p><b>Page 45:</b> Changed and added view angle, life expectancy, and brightness adjustment specifications.</p> <p><b>Page 46:</b> Changed last note and added note after it.</p> <p><b>Page 62:</b> Added model numbers to note.</p> <p><b>Page 75:</b> Added sentence after table.</p> <p><b>Page 93:</b> Added two lines to Ambient Conditions.</p> <p><b>Page 128:</b> Added row on backlight adjustment.</p> <p><b>Page 143:</b> Replaced figures at top of page.</p> <p><b>Page 145:</b> Added sentence to the end of 8-3-5 Backlight.</p> <p><b>Page 149:</b> Added note.</p> <p><b>Page 205:</b> Changed last paragraph in 11-3-1 Backlight.</p> <p><b>Page 215:</b> Changed model numbers in table.</p> <p><b>Page 217:</b> Changed row for address \$SW12 and added footnote to table.</p> <p><b>Page 218:</b> Added appendix.</p>





# Terms and Conditions of Sale

1. **Offer; Acceptance.** These terms and conditions (these "Terms") are deemed part of all quotes, agreements, purchase orders, acknowledgments, price lists, catalogs, manuals, brochures and other documents, whether electronic or in writing, relating to the sale of products or services (collectively, the "Products") by Omron Electronics LLC and its subsidiary companies ("Omron"). Omron objects to any terms or conditions proposed in Buyer's purchase order or other documents which are inconsistent with, or in addition to, these Terms.
2. **Prices; Payment Terms.** All prices stated are current, subject to change without notice by Omron. Omron reserves the right to increase or decrease prices on any unshipped portions of outstanding orders. Payments for Products are due net 30 days unless otherwise stated in the invoice.
3. **Discounts.** Cash discounts, if any, will apply only on the net amount of invoices sent to Buyer after deducting transportation charges, taxes and duties, and will be allowed only if (i) the invoice is paid according to Omron's payment terms and (ii) Buyer has no past due amounts.
4. **Interest.** Omron, at its option, may charge Buyer 1-1/2% interest per month or the maximum legal rate, whichever is less, on any balance not paid within the stated terms.
5. **Orders.** Omron will accept no order less than \$200 net billing.
6. **Governmental Approvals.** Buyer shall be responsible for, and shall bear all costs involved in, obtaining any government approvals required for the importation or sale of the Products.
7. **Taxes.** All taxes, duties and other governmental charges (other than general real property and income taxes), including any interest or penalties thereon, imposed directly or indirectly on Omron or required to be collected directly or indirectly by Omron for the manufacture, production, sale, delivery, importation, consumption or use of the Products sold hereunder (including customs duties and sales, excise, use, turnover and license taxes) shall be charged to and remitted by Buyer to Omron.
8. **Financial.** If the financial position of Buyer at any time becomes unsatisfactory to Omron, Omron reserves the right to stop shipments or require satisfactory security or payment in advance. If Buyer fails to make payment or otherwise comply with these Terms or any related agreement, Omron may (without liability and in addition to other remedies) cancel any unshipped portion of Products sold hereunder and stop any Products in transit until Buyer pays all amounts, including amounts payable hereunder, whether or not then due, which are owing to it by Buyer. Buyer shall in any event remain liable for all unpaid accounts.
9. **Cancellation; Etc.** Orders are not subject to rescheduling or cancellation unless Buyer indemnifies Omron against all related costs or expenses.
10. **Force Majeure.** Omron shall not be liable for any delay or failure in delivery resulting from causes beyond its control, including earthquakes, fires, floods, strikes or other labor disputes, shortage of labor or materials, accidents to machinery, acts of sabotage, riots, delay in or lack of transportation or the requirements of any government authority.
11. **Shipping; Delivery.** Unless otherwise expressly agreed in writing by Omron:
  - a. Shipments shall be by a carrier selected by Omron; Omron will not drop ship except in "break down" situations.
  - b. Such carrier shall act as the agent of Buyer and delivery to such carrier shall constitute delivery to Buyer;
  - c. All sales and shipments of Products shall be FOB shipping point (unless otherwise stated in writing by Omron), at which point title and risk of loss shall pass from Omron to Buyer; provided that Omron shall retain a security interest in the Products until the full purchase price is paid;
  - d. Delivery and shipping dates are estimates only; and
  - e. Omron will package Products as it deems proper for protection against normal handling and extra charges apply to special conditions.
12. **Claims.** Any claim by Buyer against Omron for shortage or damage to the Products occurring before delivery to the carrier must be presented in writing to Omron within 30 days of receipt of shipment and include the original transportation bill signed by the carrier noting that the carrier received the Products from Omron in the condition claimed.
13. **Warranties.** (a) **Exclusive Warranty.** Omron's exclusive warranty is that the Products will be free from defects in materials and workmanship for a period of twelve months from the date of sale by Omron (or such other period expressed in writing by Omron). Omron disclaims all other warranties, express or implied. (b) **Limitations.** OMRON MAKES NO WARRANTY OR REPRESENTATION, EXPRESS OR IMPLIED, ABOUT NON-INFRINGEMENT, MERCHANTABILITY OR FITNESS FOR A PARTICULAR PURPOSE OF THE PRODUCTS. BUYER ACKNOWLEDGES THAT IT ALONE HAS DETERMINED THAT THE PRODUCTS WILL SUITABLY MEET THE REQUIREMENTS OF THEIR INTENDED USE. Omron further disclaims all warranties and responsibility of any type for claims or expenses based on infringement by the Products or otherwise of any intellectual property right. (c) **Buyer Remedy.** Omron's sole obligation hereunder shall be, at Omron's election, to (i) replace (in the form originally shipped with Buyer responsible for labor charges for removal or replacement thereof) the non-complying Product, (ii) repair the non-complying Product, or (iii) repay or credit Buyer an amount equal to the purchase price of the non-complying Product; provided that in no event shall Omron be responsible for warranty, repair, indemnity or any other claims or expenses regarding the Products unless Omron's analysis confirms that the Products were properly handled, stored, installed and maintained and not subject to contamination, abuse, misuse or inappropriate modification. Return of any Products by Buyer must be approved in writing by Omron before shipment. Omron Companies shall not be liable for the suitability or unsuitability or the results from the use of Products in combination with any electrical or electronic components, circuits, system assemblies or any other materials or substances or environments. Any advice, recommendations or information given orally or in writing, are not to be construed as an amendment or addition to the above warranty. See <http://www.omron247.com> or contact your Omron representative for published information.
14. **Limitation on Liability; Etc.** OMRON COMPANIES SHALL NOT BE LIABLE FOR SPECIAL, INDIRECT, INCIDENTAL, OR CONSEQUENTIAL DAMAGES, LOSS OF PROFITS OR PRODUCTION OR COMMERCIAL LOSS IN ANY WAY CONNECTED WITH THE PRODUCTS, WHETHER SUCH CLAIM IS BASED IN CONTRACT, WARRANTY, NEGLIGENCE OR STRICT LIABILITY. Further, in no event shall liability of Omron Companies exceed the individual price of the Product on which liability is asserted.
15. **Indemnities.** Buyer shall indemnify and hold harmless Omron Companies and their employees from and against all liabilities, losses, claims, costs and expenses (including attorney's fees and expenses) related to any claim, investigation, litigation or proceeding (whether or not Omron is a party) which arises or is alleged to arise from Buyer's acts or omissions under these Terms or in any way with respect to the Products. Without limiting the foregoing, Buyer (at its own expense) shall indemnify and hold harmless Omron and defend or settle any action brought against such Companies to the extent based on a claim that any Product made to Buyer specifications infringed intellectual property rights of another party.
16. **Property; Confidentiality.** Any intellectual property in the Products is the exclusive property of Omron Companies and Buyer shall not attempt to duplicate it in any way without the written permission of Omron. Notwithstanding any charges to Buyer for engineering or tooling, all engineering and tooling shall remain the exclusive property of Omron. All information and materials supplied by Omron to Buyer relating to the Products are confidential and proprietary, and Buyer shall limit distribution thereof to its trusted employees and strictly prevent disclosure to any third party.
17. **Export Controls.** Buyer shall comply with all applicable laws, regulations and licenses regarding (i) export of products or information; (ii) sale of products to "forbidden" or other proscribed persons; and (iii) disclosure to non-citizens of regulated technology or information.
18. **Miscellaneous.** (a) **Waiver.** No failure or delay by Omron in exercising any right and no course of dealing between Buyer and Omron shall operate as a waiver of rights by Omron. (b) **Assignment.** Buyer may not assign its rights hereunder without Omron's written consent. (c) **Law.** These Terms are governed by the law of the jurisdiction of the home office of the Omron company from which Buyer is purchasing the Products (without regard to conflict of law principles). (d) **Amendment.** These Terms constitute the entire agreement between Buyer and Omron relating to the Products, and no provision may be changed or waived unless in writing signed by the parties. (e) **Severability.** If any provision hereof is rendered ineffective or invalid, such provision shall not invalidate any other provision. (f) **Setoff.** Buyer shall have no right to set off any amounts against the amount owing in respect of this invoice. (g) **Definitions.** As used herein, "including" means "including without limitation"; and "Omron Companies" (or similar words) mean Omron Corporation and any direct or indirect subsidiary or affiliate thereof.

## Certain Precautions on Specifications and Use

1. **Suitability of Use.** Omron Companies shall not be responsible for conformity with any standards, codes or regulations which apply to the combination of the Product in the Buyer's application or use of the Product. At Buyer's request, Omron will provide applicable third party certification documents identifying ratings and limitations of use which apply to the Product. This information by itself is not sufficient for a complete determination of the suitability of the Product in combination with the end product, machine, system, or other application or use. Buyer shall be solely responsible for determining appropriateness of the particular Product with respect to Buyer's application, product or system. Buyer shall take application responsibility in all cases but the following is a non-exhaustive list of applications for which particular attention must be given: (i) Outdoor use, uses involving potential chemical contamination or electrical interference, or conditions or uses not described in this document. (ii) Use in consumer products or any use in significant quantities. (iii) Energy control systems, combustion systems, railroad systems, aviation systems, medical equipment, amusement machines, vehicles, safety equipment, and installations subject to separate industry or government regulations. (iv) Systems, machines and equipment that could present a risk to life or property. Please know and observe all prohibitions of use applicable to this Product. NEVER USE THE PRODUCT FOR AN APPLICATION INVOLVING SERIOUS RISK TO LIFE OR PROPERTY OR IN LARGE QUANTITIES WITHOUT ENSURING THAT THE SYSTEM AS A WHOLE HAS BEEN DESIGNED TO ADDRESS THE RISKS, AND THAT THE OMRON'S PRODUCT IS PROPERLY RATED AND INSTALLED FOR THE INTENDED USE WITHIN THE OVERALL EQUIPMENT OR SYSTEM.
2. **Programmable Products.** Omron Companies shall not be responsible for the user's programming of a programmable Product, or any consequence thereof.
3. **Performance Data.** Data presented in Omron Company websites, catalogs and other materials is provided as a guide for the user in determining suitability and does not constitute a warranty. It may represent the result of Omron's test conditions, and the user must correlate it to actual application requirements. Actual performance is subject to the Omron's Warranty and Limitations of Liability.
4. **Change in Specifications.** Product specifications and accessories may be changed at any time based on improvements and other reasons. It is our practice to change part numbers when published ratings or features are changed, or when significant construction changes are made. However, some specifications of the Product may be changed without any notice. When in doubt, special part numbers may be assigned to fix or establish key specifications for your application. Please consult with your Omron's representative at any time to confirm actual specifications of purchased Product.
5. **Errors and Omissions.** Information presented by Omron Companies has been checked and is believed to be accurate; however, no responsibility is assumed for clerical, typographical or proofreading errors or omissions.



**OMRON ELECTRONICS LLC • THE AMERICAS HEADQUARTERS** • Schaumburg, IL USA • 847.843.7900 • 800.556.6766 • [www.omron247.com](http://www.omron247.com)

**OMRON CANADA, INC. • HEAD OFFICE**

Toronto, ON, Canada • 416.286.6465 • 866.986.6766  
[www.omron247.com](http://www.omron247.com)

**OMRON ELETRÔNICA DO BRASIL LTDA • HEAD OFFICE**

São Paulo, SP, Brasil • 55.11.2101.6300 • [www.omron.com.br](http://www.omron.com.br)

**OMRON ELECTRONICS MEXICO SA DE CV • HEAD OFFICE**

Apodaca, N.L. • 52.811.156.99.10 • 001.800.556.6766 • [mela@omron.com](mailto:mela@omron.com)

**OMRON ARGENTINA • SALES OFFICE**

Cono Sur • 54.11.4783.5300

**OMRON CHILE • SALES OFFICE**

Santiago • 56.9.9917.3920

**OTHER OMRON LATIN AMERICA SALES**

54.11.4783.5300

**OMRON EUROPE B.V.** Wegalaan 67-69, NL-2132 JD, Hoofddorp, The Netherlands. Tel: +31 (0) 23 568 13 00 Fax: +31 (0) 23 568 13 88 [www.industrial.omron.eu](http://www.industrial.omron.eu)