

PRODUCT NUMBER SEE SHEET 2

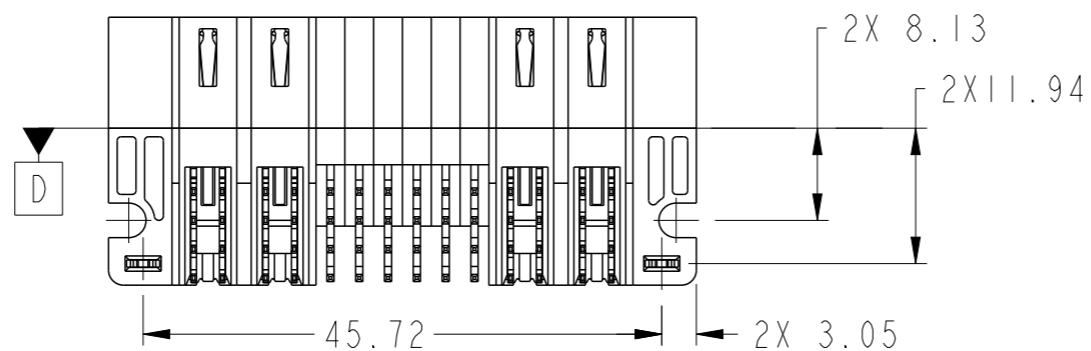

spec ref	*	dr	Peng-Bing Fu	2012/09/02	projection	MM	size	A3	scale	3:2	
tolerance std	ASME Y14.5	eng	Peng-Bing Fu	2013/03/15			ecn no	-	rel level	Released	
TOLERANCES UNLESS OTHERWISE SPECIFIED		chr	-	-			product family	PwrBlade+	rel level	Released	
surface	linear	0.X	±0.5		2HP + 24S + 2HP		dwg no 10106124-4006003	rev		A	
		0.XX	±0.25		RA STB HEADER						
		0.XXX	±0.10		www.fci.com						
ASME Y14.5	angular	0°	±2°	cat. no.	Product - Customer Drw		sheet 1 of 3				

PRODUCT NO.	ROWS	H P		SIGNAL						H P			
		E1	P1	P2	1	2	3	4	5	6	P3	P4	E2
10106124-4006003LF	DCBA	HA	H1	H1	UUUUUU	UUUUUU	UUUUUU	UUUUUU	UUUUUU	UUUUUU	H1	H1	HA

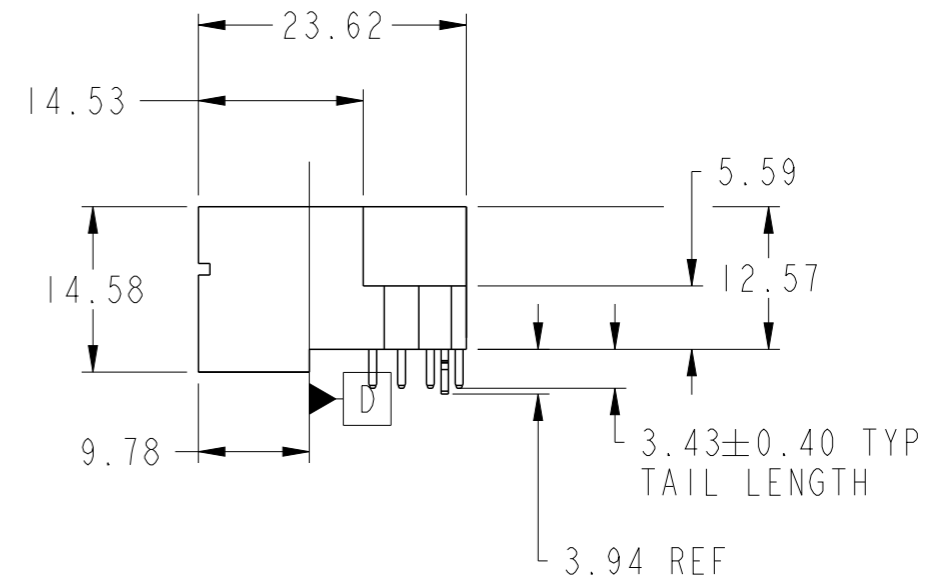
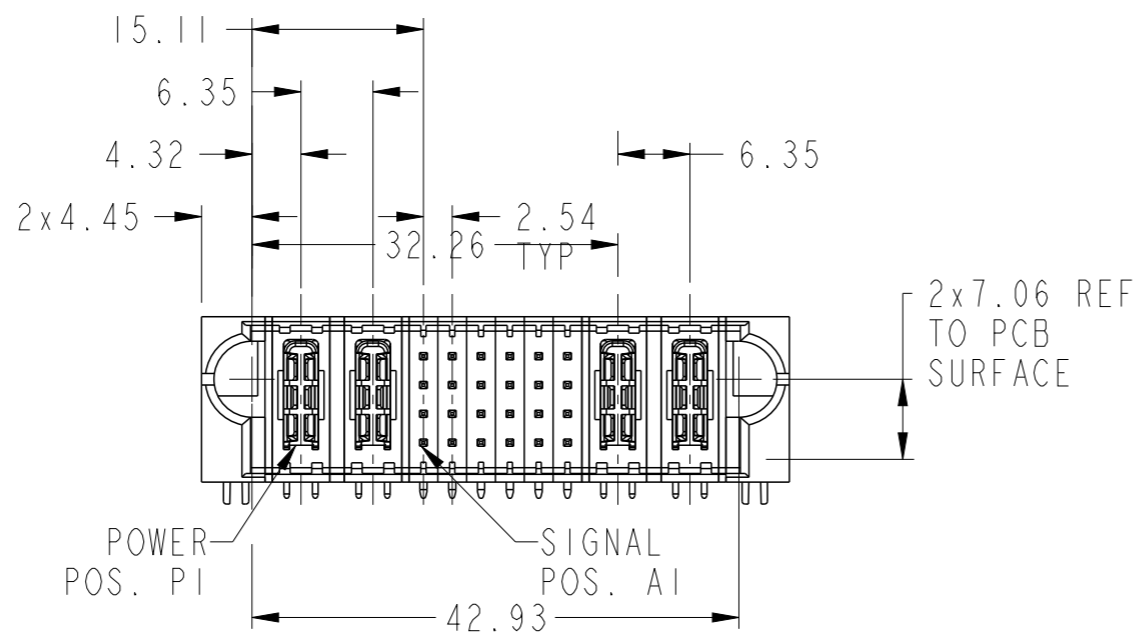
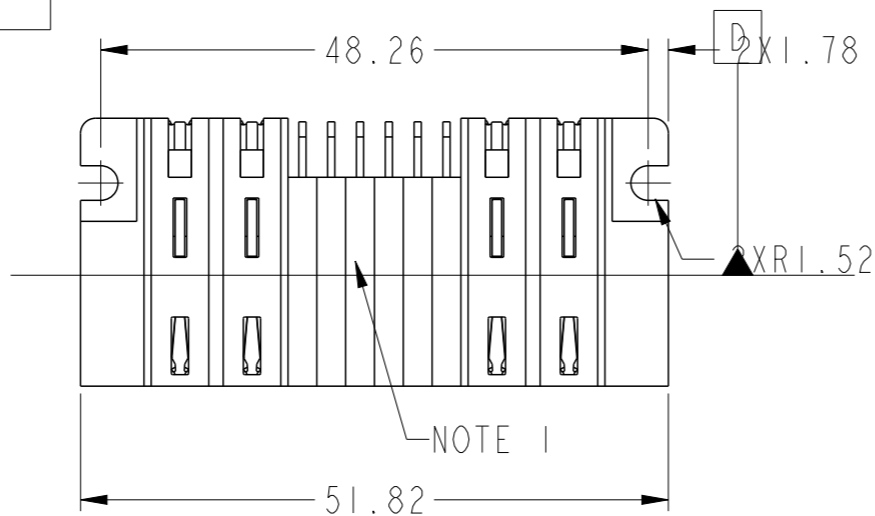
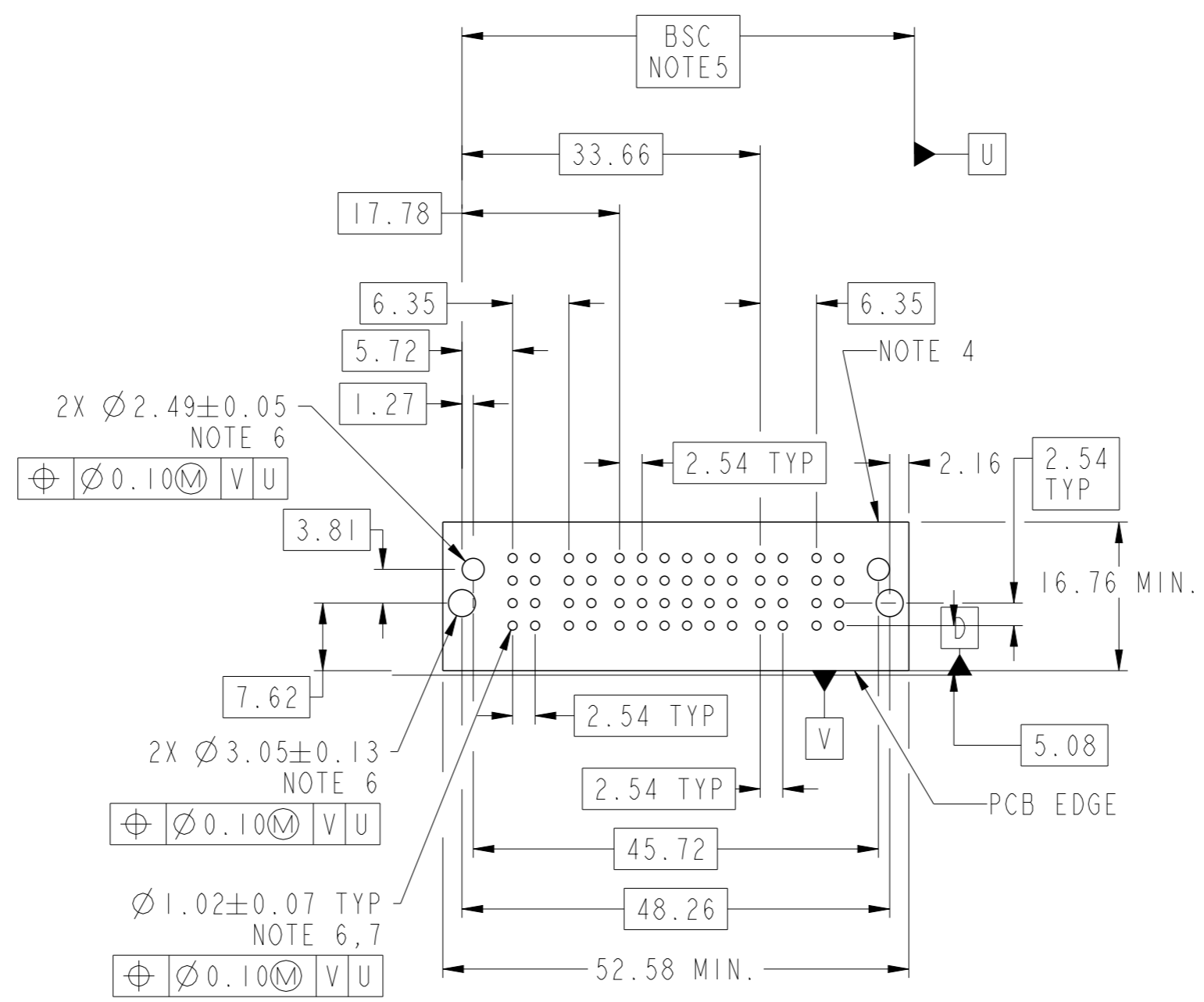

CODE	DESCRIPTION
HI	STD HIGH POWER CONTACT (3.43)
HA	METAL HOLD DOWN
R	STD SIGNAL CONTACT, ROW A (3.43)
S	STD SIGNAL CONTACT, ROW B (3.43)
T	STD SIGNAL CONTACT, ROW C (3.43)
U	STD SIGNAL CONTACT, ROW D (3.43)

dr	Peng-Bing Fu	2012/09/02	projection	MM	size	A3	scale	3:2		
eng	Peng-Bing Fu	2013/03/15			ecn no		-			
chr	-	-			rel level		Released		-	
appr	Pei-Ming Zheng	2013/03/15	product family		PwrBlade+		-			
			2HP + 24S + 2HP			dwg no		10106124-4006003	rev	A
www.fci.com			cat. no.			Product - Customer Drw			sheet 2 of 3	



Copyright FCI.

NOTES:

- 1) "FCI", PART NUMBER AND DATE CODE TO BE MARKED ON THIS SURFACE.
THE MARK CAN BE OMITTED IF THERE IS NOT ENOUGH SPACE ON THIS SURFACE.
- 2) MATERIALS:
-HOUSING - GLASS FILLED WITH HIGH TEMP THERMOPLASTIC, UL94V-0.
-SIGNAL CONTACT - COPPER ALLOY.
-POWER CONTACT - HIGH CONDUCTIVITY COPPER ALLOY.
- 3) PLATING SPECIFICATION REFER TO FCI 10116351
- 4) DENOTES CONNECTOR KEEP OUT ZONE.
- 5) DATUM AND BASIC DIMENSIONS WERE ESTABLISHED BY CUSTOMER.
- 6) ALL HOLE DIAMETERS ARE FINISHED HOLE SIZES.
- 7) 1.15 ± 0.025 MM DRILLED HOLE PLATED WITH 0.00762MM MIN Sn
OVER 0.0254-0.0762MM Cu PLATING TO ACHIEVE A 1.02 ± 0.07 MM HOLE.
- 8) PRODUCT SPECIFICATION REFER TO FCI GS-12-658.
APPLICATION SPECIFICATION REFER TO FCI GS-20-141.
PRODUCT PACKAGED IN TRAYS, REFER TO FCI GS-14-1502.

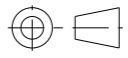
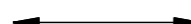

Copyright FCI.

dr	Peng-Bing Fu	2012/09/02	projection 	MM 	size	A3	scale	3:2
eng	Peng-Bing Fu	2013/03/15			ecn no	-		
chr	-	-			rel level	Released		
appr	Pei-Ming Zheng	2013/03/15	product family	PwrBlade+				
		2HP + 24S +2HP RA STB HEADER		dwg no 10106124-4006003	rev A			
www.fci.com		cat. no.	Product - Customer Drw		sheet 3 of 3			