

# GenX3™ 600V IGBTs with Diode

# IXGH60N60C3D1 IXGT60N60C3D1

$V_{CES} = 600V$   
 $I_{C110} = 60A$   
 $V_{CE(sat)} \leq 2.5V$   
 $t_{fi} (typ) = 50ns$

High Speed PT IGBTs for  
40-100kHz switching

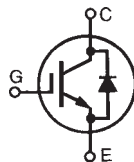

Symbol	Test Conditions	Maximum Ratings	
$V_{CES}$	$T_J = 25^\circ C$ to $150^\circ C$	600	V
$V_{CGR}$	$T_J = 25^\circ C$ to $150^\circ C$ , $R_{GE} = 1M\Omega$	600	V
$V_{GES}$	Continuous	$\pm 20$	V
$V_{GEM}$	Transient	$\pm 30$	V
$I_{C25}$	$T_C = 25^\circ C$ , (Limited by Leads)	75	A
$I_{C110}$	$T_C = 110^\circ C$	60	A
$I_{F110}$	$T_C = 110^\circ C$	26	A
$I_{CM}$	$T_C = 25^\circ C$ , 1ms	300	A
$I_A$	$T_C = 25^\circ C$	40	A
$E_{AS}$	$T_C = 25^\circ C$	400	mJ
<b>SSOA</b> <b>(RBSOA)</b>	$V_{GE} = 15V$ , $T_{VJ} = 125^\circ C$ , $R_G = 3\Omega$ Clamped Inductive Load	$I_{CM} = 125$ $V_{CE} \leq V_{CES}$	A
$P_C$	$T_C = 25^\circ C$	380	W
$T_J$		-55 ... +150	$^\circ C$
$T_{JM}$		150	$^\circ C$
$T_{stg}$		-55 ... +150	$^\circ C$
$T_L$	Maximum Lead Temperature for Soldering	300	$^\circ C$
$T_{SOLD}$	1.6 mm (0.062in.) from Case for 10s	260	$^\circ C$
$M_d$	Mounting Torque (TO-247)	1.13/10	Nm/lb.in.
<b>Weight</b>	TO-268	4	g
	TO-247	6	g

TO-247 (IXGH)

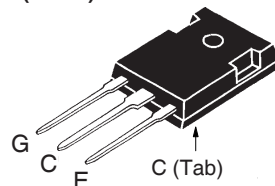

TO-268 (IXGT)

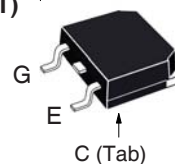

G = Gate      C = Collector  
 E = Emitter    Tab = Collector

## Features

- Optimized for Low Switching Losses
- Square RBSOA
- High Avalanche Capability
- Anti-Parallel Ultra Fast Diode
- International Standard Packages

## Advantages

- High Power Density
- Low Gate Drive Requirement

## Applications

- High Frequency Power Inverters
- UPS
- Motor Drives
- SMPS
- PFC Circuits
- Battery Chargers
- Welding Machines
- Lamp Ballasts

Symbol	Test Conditions ( $T_J = 25^\circ C$ , Unless Otherwise Specified)	Characteristic Values		
		Min.	Typ.	Max.
$V_{GE(th)}$	$I_C = 250\mu A$ , $V_{CE} = V_{GE}$	3.0		5.5 V
$I_{CES}$	$V_{CE} = V_{CES}$ , $V_{GE} = 0V$ $T_J = 125^\circ C$			50 $\mu A$ 1 mA
$I_{GES}$	$V_{CE} = 0V$ , $V_{GE} = \pm 20V$			$\pm 100$ nA
$V_{CE(sat)}$	$I_C = 40A$ , $V_{GE} = 15V$ $T_J = 125^\circ C$		2.2 1.7	2.5 V V

Symbol	Test Conditions ( $T_J = 25^\circ\text{C}$ , Unless Otherwise Specified)	Characteristic Values			
		Min.	Typ.	Max.	
$g_{fs}$	$I_C = 40\text{A}$ , $V_{CE} = 10\text{V}$ , Note 1	23	38	S	
$C_{ies}$	$V_{CE} = 25\text{V}$ , $V_{GE} = 0\text{V}$ , $f = 1\text{MHz}$		2810	pF	
$C_{oes}$			210	pF	
$C_{res}$			80	pF	
$Q_g$	$I_C = 40\text{A}$ , $V_{GE} = 15\text{V}$ , $V_{CE} = 0.5 \cdot V_{CES}$		115	nC	
$Q_{ge}$			22	nC	
$Q_{gc}$			43	nC	
$t_{d(on)}$	<b>Inductive Load, <math>T_J = 125^\circ\text{C}</math></b> $I_C = 40\text{A}$ , $V_{GE} = 15\text{V}$ $V_{CE} = 480\text{V}$ , $R_G = 3\Omega$ Note 2		21	ns	
$t_{ri}$			33	ns	
$E_{on}$			0.80	mJ	
$t_{d(off)}$			70	110	ns
$t_{fi}$			50	ns	
$E_{off}$			0.45	0.80	mJ
$t_{d(on)}$	<b>Inductive Load, <math>T_J = 125^\circ\text{C}</math></b> $I_C = 40\text{A}$ , $V_{GE} = 15\text{V}$ $V_{CE} = 480\text{V}$ , $R_G = 3\Omega$ Note 2		21	ns	
$t_{ri}$			33	ns	
$E_{on}$			1.25	mJ	
$t_{d(off)}$			112	ns	
$t_{fi}$			86	ns	
$E_{off}$			0.80	mJ	
$R_{thJC}$			0.33	$^\circ\text{C/W}$	
$R_{thCK}$		0.21		$^\circ\text{C/W}$	

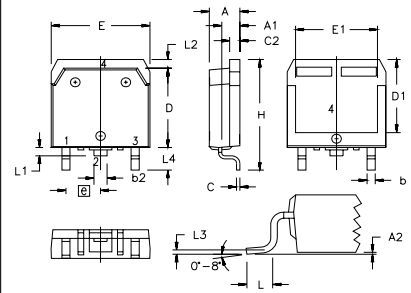
**TO-268 (IXGT) Outline**

 Terminals: 1 - Gate  
 2 - Collector  
 3 - Emitter  
 Tab - Collector

SYM	INCHES		MILLIMETERS	
	MIN	MAX	MIN	MAX
A	.193	.201	4.90	5.10
A1	.106	.114	2.70	2.90
A2	.001	.010	0.02	0.25
b	.045	.057	1.15	1.45
b2	.075	.083	1.90	2.10
C	.016	.026	0.40	0.65
C2	.057	.063	1.45	1.60
D	.543	.551	13.80	14.00
D1	.488	.500	12.40	12.70
E	.624	.632	15.85	16.05
E1	.524	.535	13.30	13.60
e	.215 BSC		5.45 BSC	
H	.736	.752	18.70	19.10
L	.094	.106	2.40	2.70
L1	.047	.055	1.20	1.40
L2	.039	.045	1.00	1.15
L3	.010 BSC		0.25 BSC	
L4	.150	.161	3.80	4.10

**Reverse Diode (FRED)**

Symbol	Test Conditions ( $T_J = 25^\circ\text{C}$ , Unless Otherwise Specified)	Characteristic Values		
		Min.	Typ.	Max.
$V_F$	$I_F = 30\text{A}$ , $V_{GE} = 0\text{V}$ , Note 1 $T_J = 150^\circ\text{C}$		1.6	2.7
$I_{RM}$	$I_F = 30\text{A}$ , $V_{GE} = 0\text{V}$ , $di_F/dt = 100\text{ A}/\mu\text{s}$ , $T_J = 100^\circ\text{C}$ $V_R = 100\text{V}$ , $T_J = 100^\circ\text{C}$ $I_F = 1\text{A}$ ; $-di/dt = 100\text{ A}/\mu\text{s}$ , $V_R = 30\text{V}$			4
$t_{rr}$			100	ns
			25	ns
$R_{thJC}$				0.9 $^\circ\text{C/W}$

**Notes:**

1. Pulse test,  $t \leq 300\mu\text{s}$ , duty cycle,  $d \leq 2\%$ .
2. Switching times & energy losses may increase for higher  $V_{CE}(\text{Clamp})$ ,  $T_J$  or  $R_G$ .

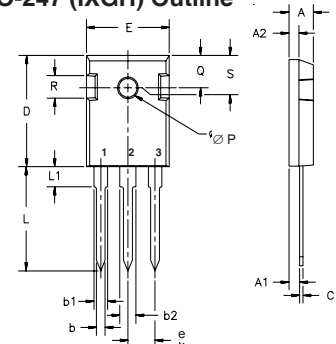
**TO-247 (IXGH) Outline**

 Terminals: 1 - Gate  
 2 - Collector  
 3 - Emitter  
 Tab - Collector

Dim.	Millimeter		Inches	
	Min.	Max.	Min.	Max.
A	4.7	5.3	.185	.209
A <sub>1</sub>	2.2	2.54	.087	.102
A <sub>2</sub>	2.2	2.6	.059	.098
b	1.0	1.4	.040	.055
b <sub>1</sub>	1.65	2.13	.065	.084
b <sub>2</sub>	2.87	3.12	.113	.123
C	.4	.8	.016	.031
D	20.80	21.46	.819	.845
E	15.75	16.26	.610	.640
e	5.20	5.72	0.205	0.225
L	19.81	20.32	.780	.800
L1		4.50		.177
∅P	3.55	3.65	.140	.144
Q	5.89	6.40	0.232	0.252
R	4.32	5.49	.170	.216
S	6.15 BSC		.242 BSC	

IXYS Reserves the Right to Change Limits, Test Conditions, and Dimensions.

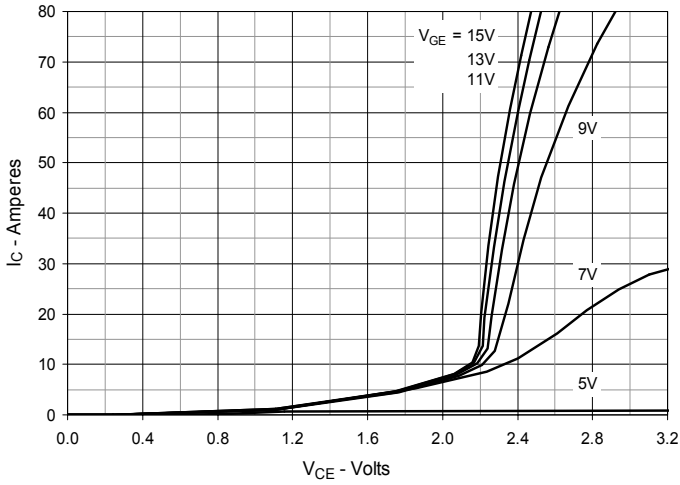
**Fig. 1. Output Characteristics @  $T_J = 25^\circ\text{C}$**



**Fig. 2. Extended Output Characteristics @  $T_J = 25^\circ\text{C}$**

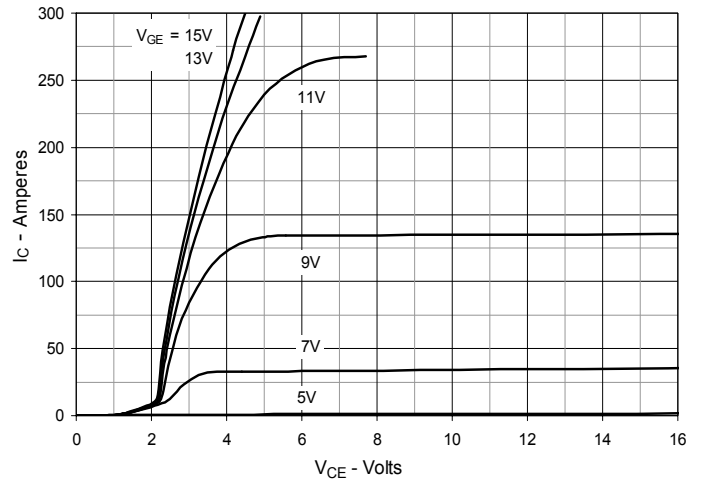

**Fig. 3. Output Characteristics @  $T_J = 125^\circ\text{C}$**

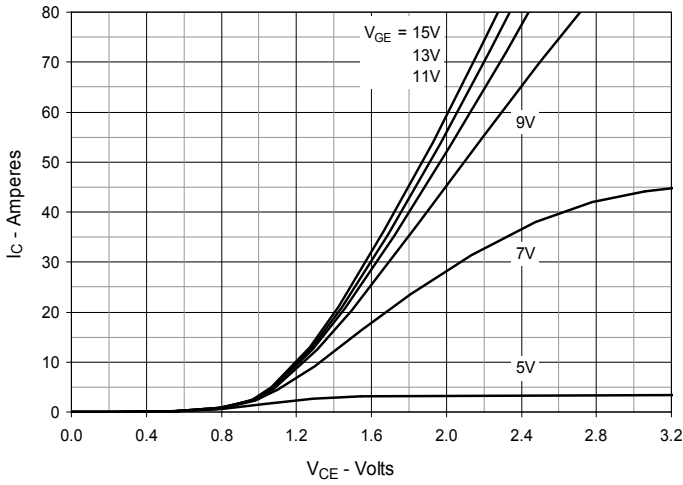

**Fig. 4. Dependence of  $V_{CE(sat)}$  on Junction Temperature**

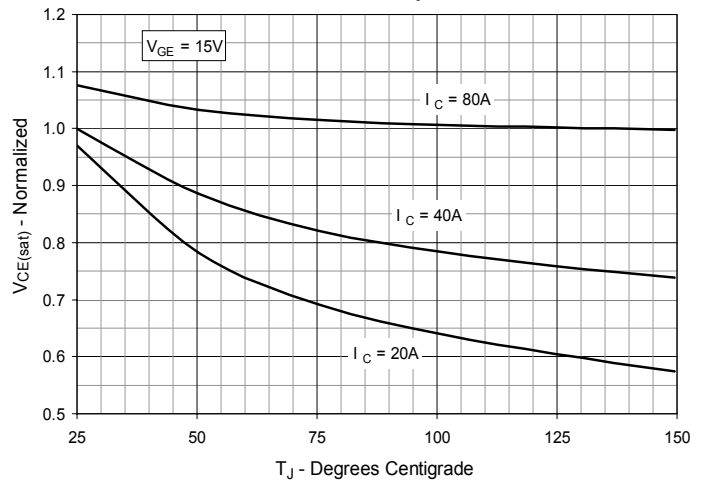

**Fig. 5. Collector-to-Emitter Voltage vs. Gate-to-Emitter Voltage**

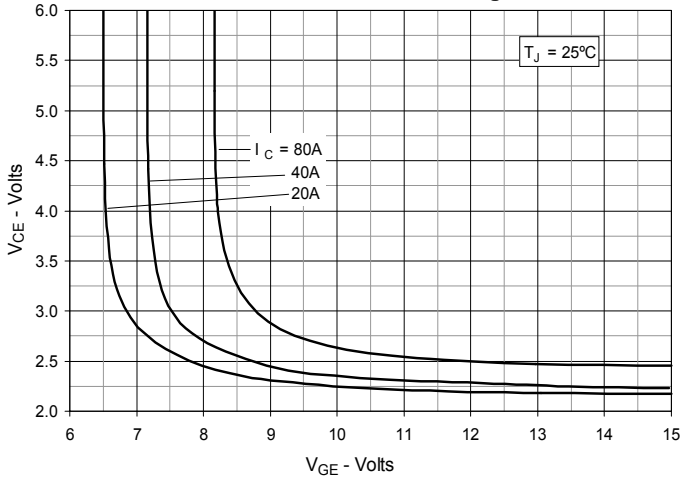

**Fig. 6. Input Admittance**

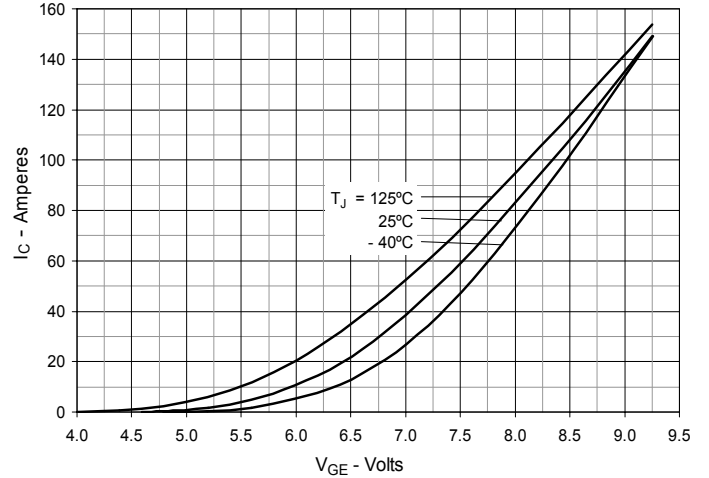

**Fig. 7. Transconductance**

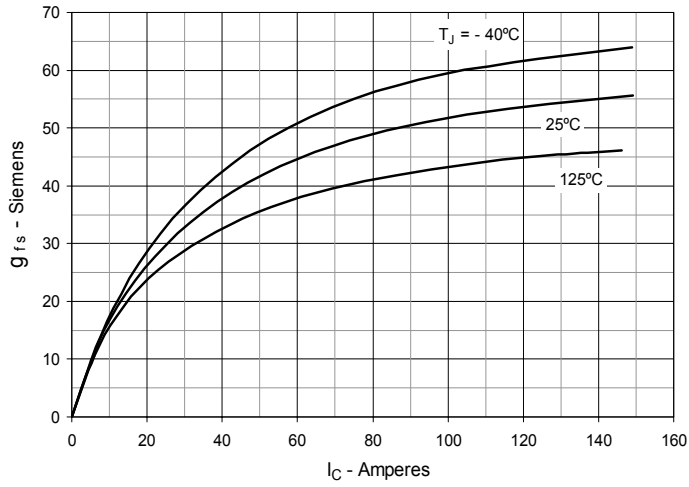

**Fig. 8. Gate Charge**

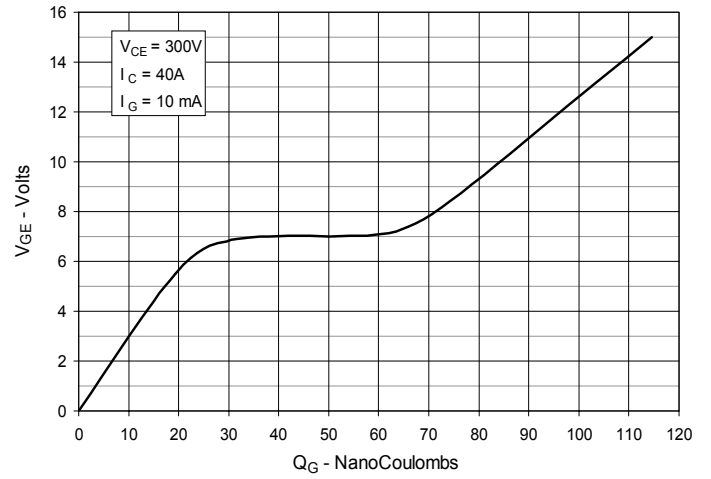

**Fig. 9. Capacitance**

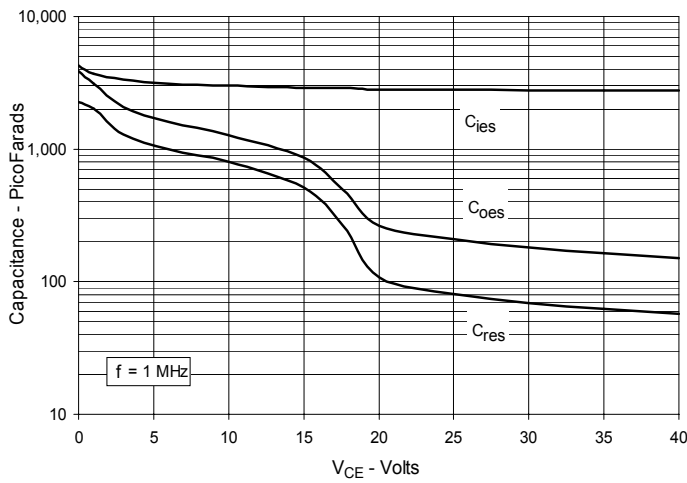

**Fig. 10. Reverse-Bias Safe Operating Area**

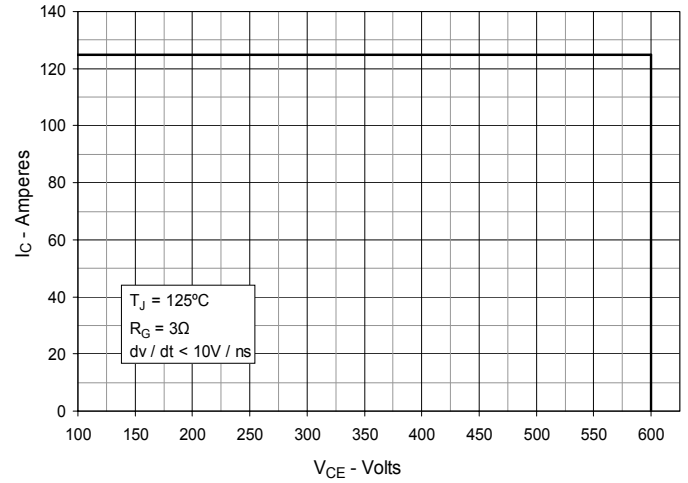

**Fig. 11. Maximum Transient Thermal Impedance**

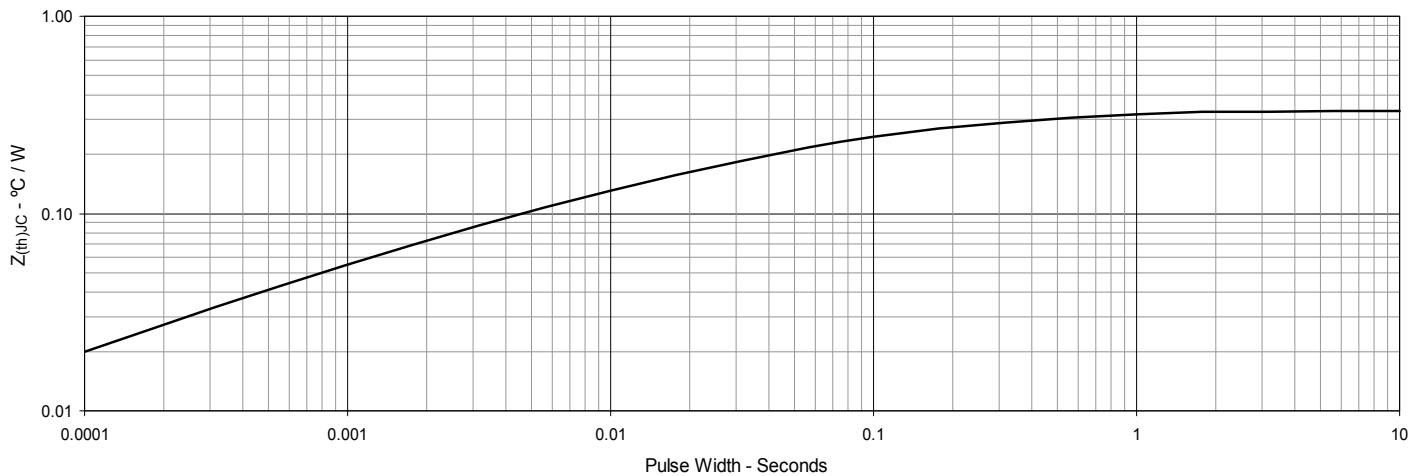

**Fig. 12. Inductive Switching Energy Loss vs. Gate Resistance**

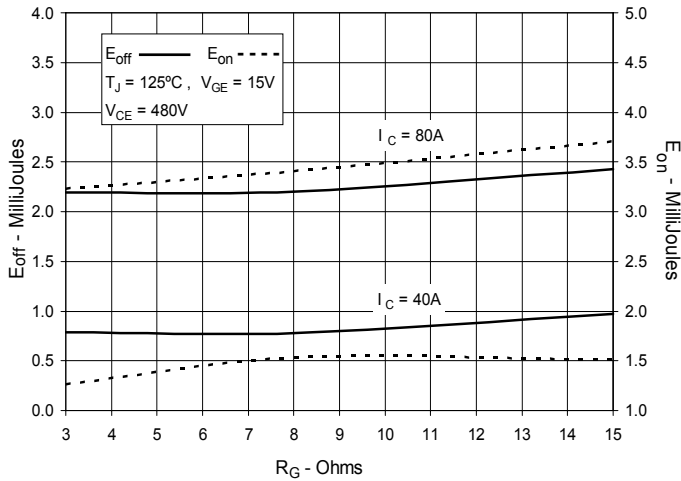

**Fig. 13. Inductive Switching Energy Loss vs. Collector Current**

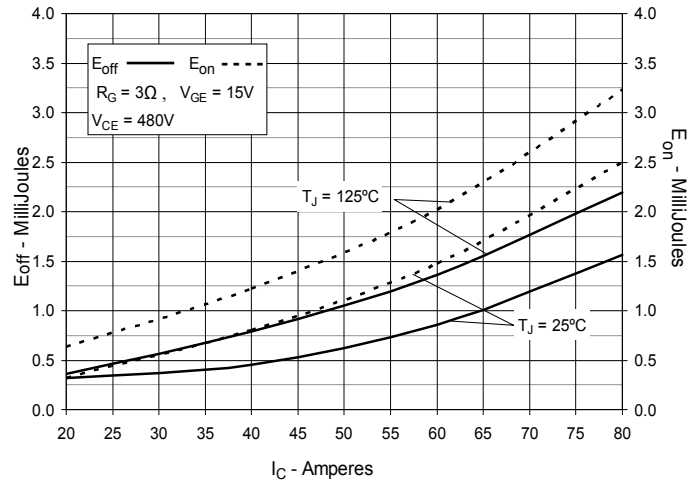

**Fig. 14. Inductive Switching Energy Loss vs. Junction Temperature**

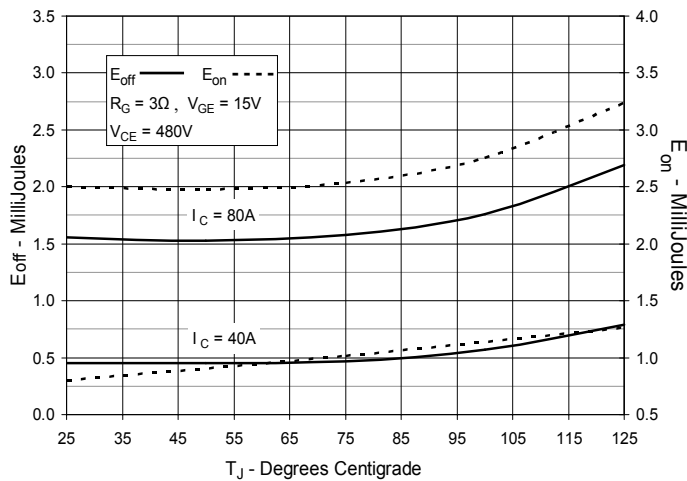

**Fig. 15. Inductive Turn-off Switching Times vs. Gate Resistance**

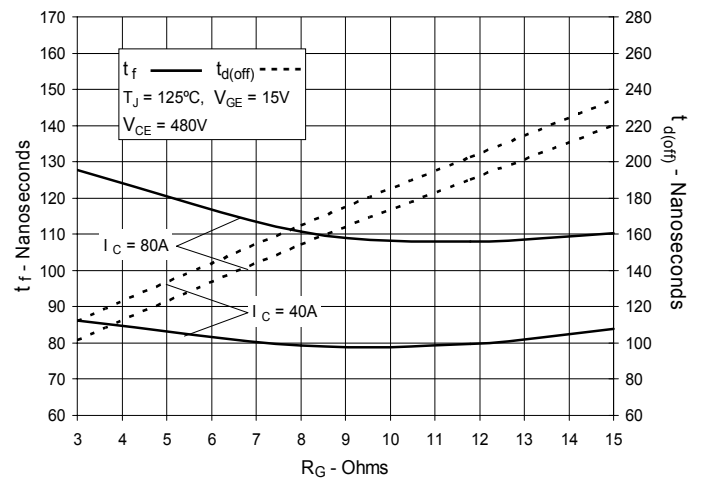

**Fig. 16. Inductive Turn-off Switching Times vs. Collector Current**

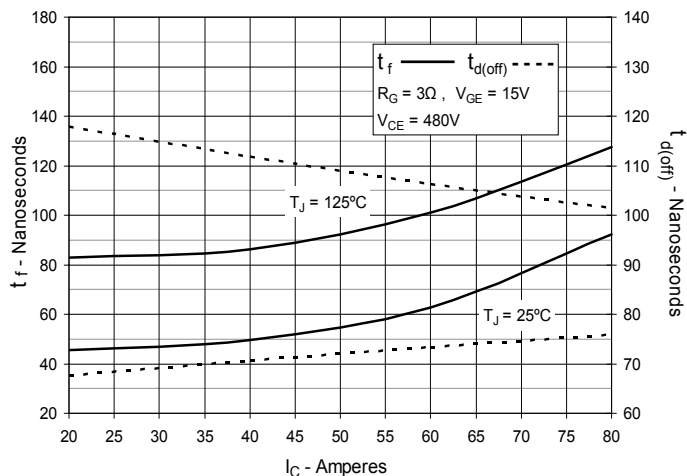

**Fig. 17. Inductive Turn-off Switching Times vs. Junction Temperature**

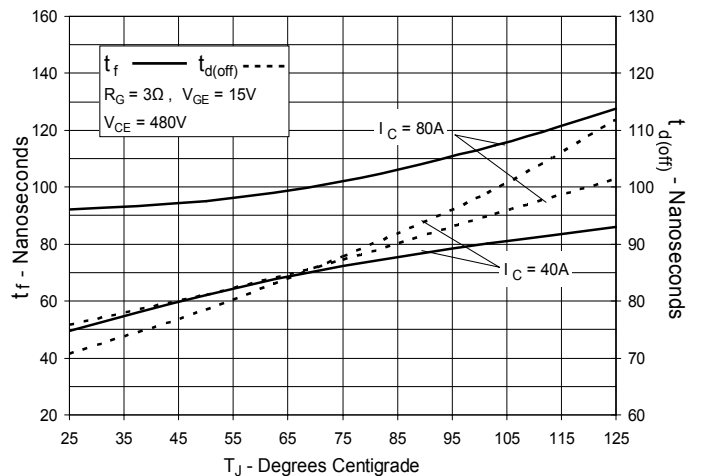

**Fig. 18. Inductive Turn-on Switching Times vs. Gate Resistance**

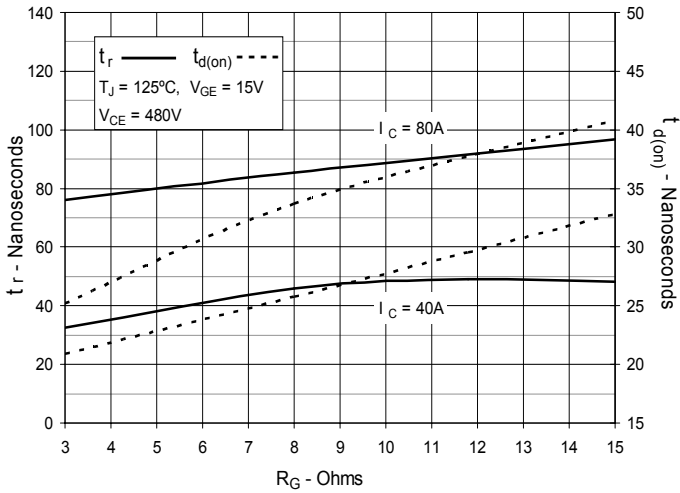

**Fig. 19. Inductive Turn-on Switching Times vs. Collector Current**

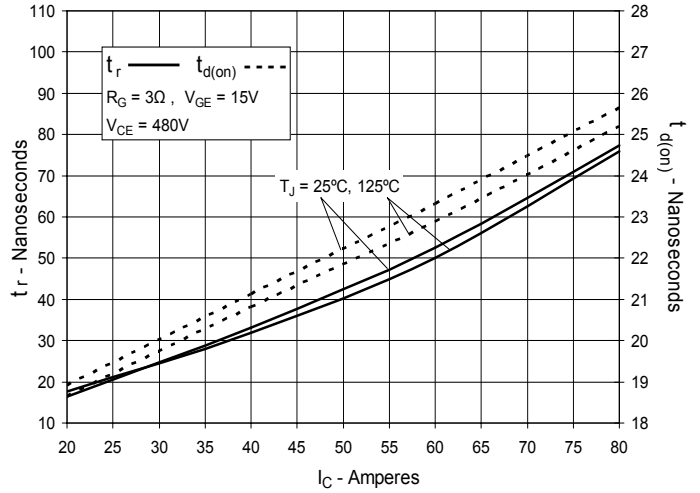

**Fig. 20. Inductive Turn-on Switching Times vs. Junction Temperature**

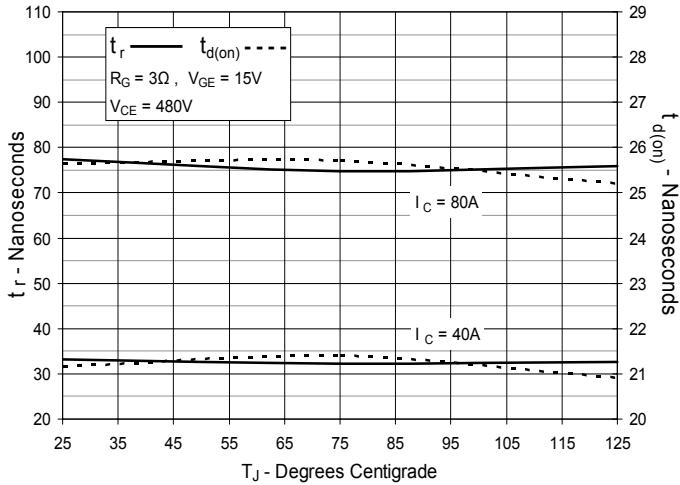

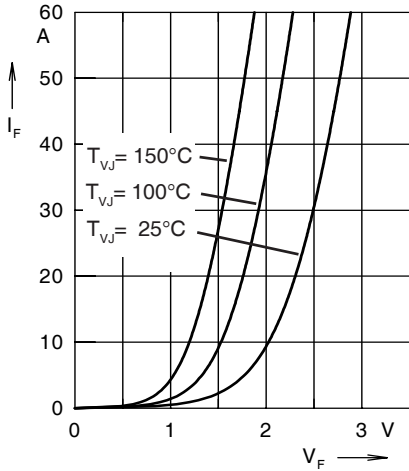

Fig. 21 Forward current  $I_F$  versus  $V_F$

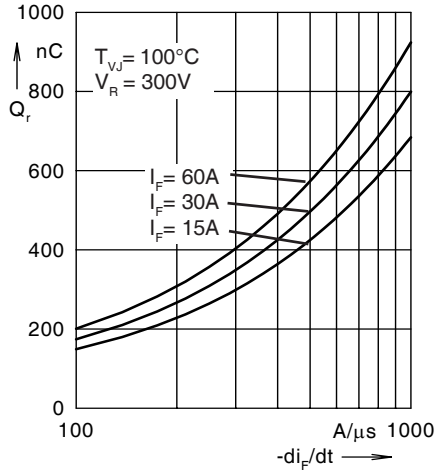

Fig. 22 Reverse recovery charge  $Q_r$  versus  $-di_F/dt$

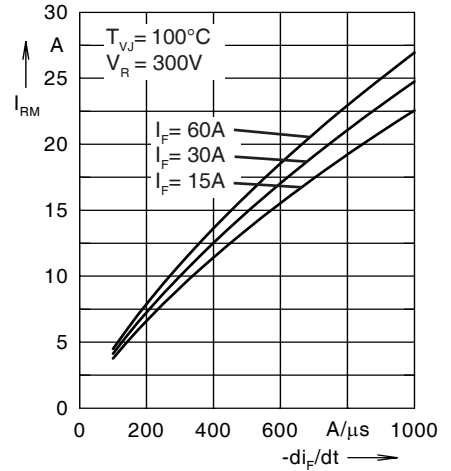

Fig. 23 Peak reverse current  $I_{RM}$  versus  $-di_F/dt$

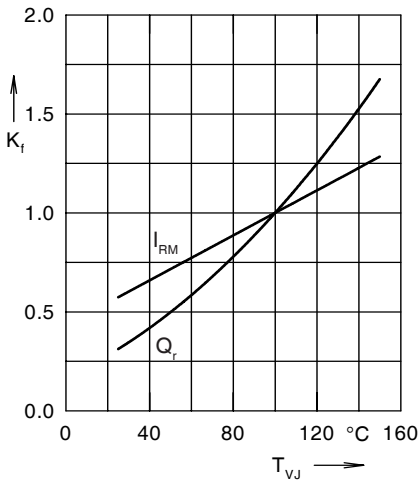

Fig. 24 Dynamic parameters  $Q_r$ ,  $I_{RM}$  versus  $T_{VJ}$

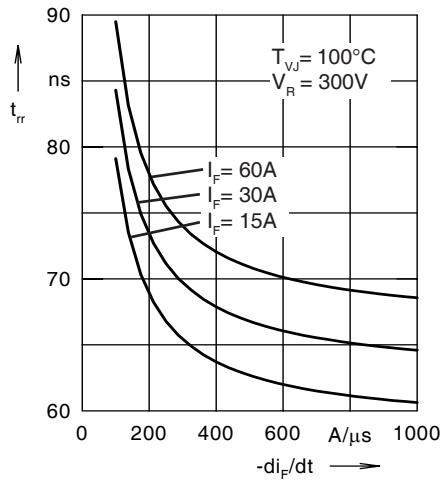

Fig. 25 Recovery time  $t_{rr}$  versus  $-di_F/dt$

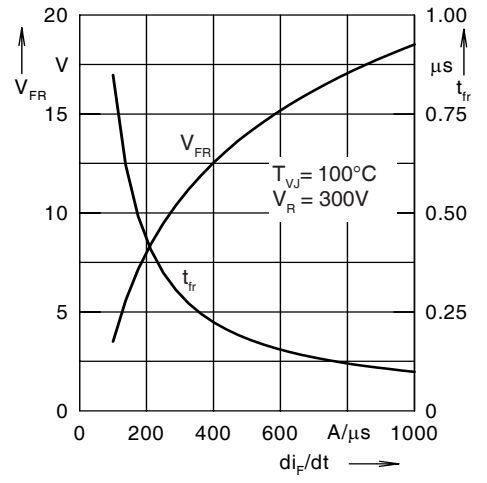

Fig. 26 Peak forward voltage  $V_{FR}$  and  $t_{fr}$  versus  $di_F/dt$

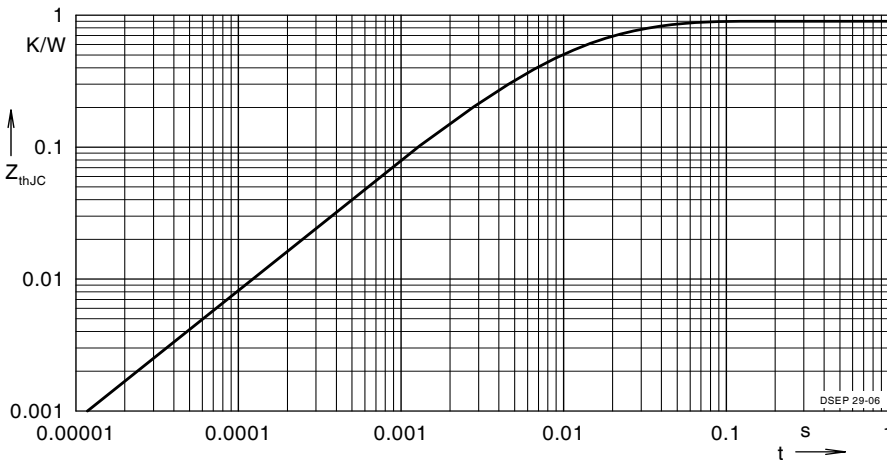

Fig. 27 Transient thermal resistance junction to case

Constants for  $Z_{thJC}$  calculation:

i	$R_{thi}$ (K/W)	$t_i$ (s)
1	0.502	0.0052
2	0.193	0.0003
3	0.205	0.0162