



250.00 MHz LVDS Oscillator

High Performance Differential Oscillator

4MA250000Z4

ADVANCE DATASHEET

Features

- Frequency: 250.00 MHz
- Output Type: LVDS
- Frequency Stability: ± 50 ppm
- Supply Voltage: 2.5V & 3.3V
- Standard Packages: 5.0 x 3.2 mm; 7.0 x 5.0 mm
- RMS phase jitter: 0.7ps typical (12k to 20MHz)
- Operating Temperature: -40 to 85 °C

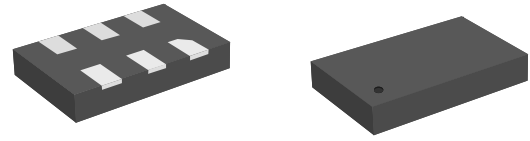

This product is rated "Green", please contact IDT for environmental compliancy information

Specification

Parameter	2.5 V Specifications			3.3 V Specifications			Units	Conditions
	Min	Typ	Max	Min	Typ	Max		
Supply Voltage (V_{DD})		2.50			3.30		V	
Output Frequency		250.00			250.00		MHz	
Frequency Stability			± 50			± 50	ppm	-40 to 85°C
Supply Current		95			95		mA	No load
Input LOW level			$0.3V_{DD}$			$0.3V_{DD}$	V	At OE pin
Input HIGH level	$0.7V_{DD}$			$0.7V_{DD}$			V	At OE pin
Output LOW level		1.075			1.075		V	
Output HIGH level		1.425			1.425		V	
Amplitude (V_A)		0.35			0.35		V	Single Ended output swing (Pk-Pk)
Mid Level (V_M)		1.25			1.25		V	
Rise Time (T_R)		400			400		ps	Maximum; 20/80% of V_A ; Output load (CL) = 2pF
Fall Time (T_F)		400			400		ps	Maximum; 20/80% of V_A ; Output load (CL) = 2pF
Symmetry (SYM)	45		55	45		55	%	Worst case; measured at 50% of waveform
Period Jitter		5			5		ps	Measured over 10k cycles, rms
Phase Jitter			1			1	ps	12k to 20MHz, rms
Aging			± 5			± 5	ppm	25°C, 10 years

Note: Above specifications are typical at room temperature (25°C) unless otherwise specified. Frequency stability includes initial frequency tolerance, temperature variation, supply voltage variation, reflow drift, and aging (+25 °C, 10 years).

Block Diagram

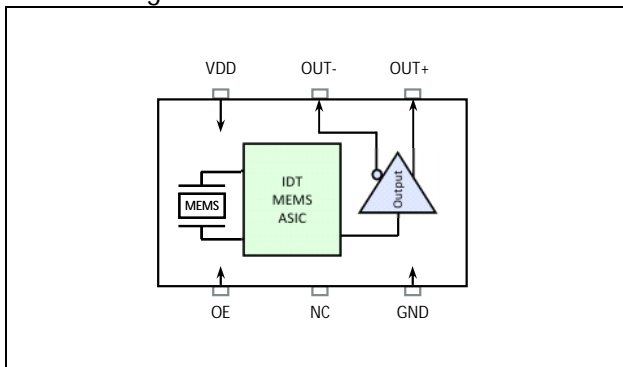

Output Waveform

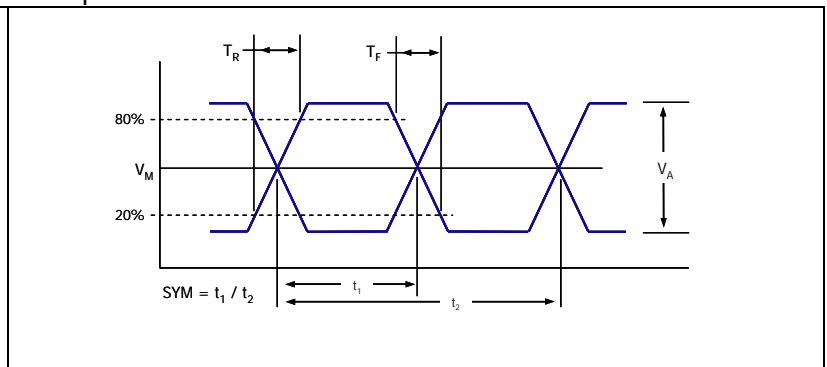

Part Ordering Information

Package Size	Voltage	Ordering Code
5.0 x 3.2 mm	3.3 V	4MA250000Z4AACTGI
	2.5 V	4MA250000Z4BACTGI
7.0 x 5.0 mm	3.3 V	4MA250000Z4AACUGI
	2.5 V	4MA250000Z4BACUGI

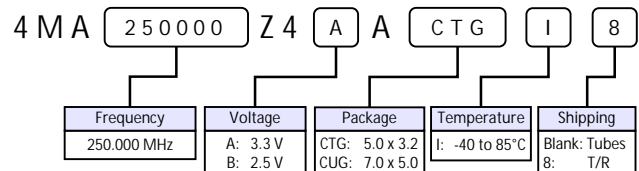

Package Outline and Dimensions

Typical PCB Land Pattern

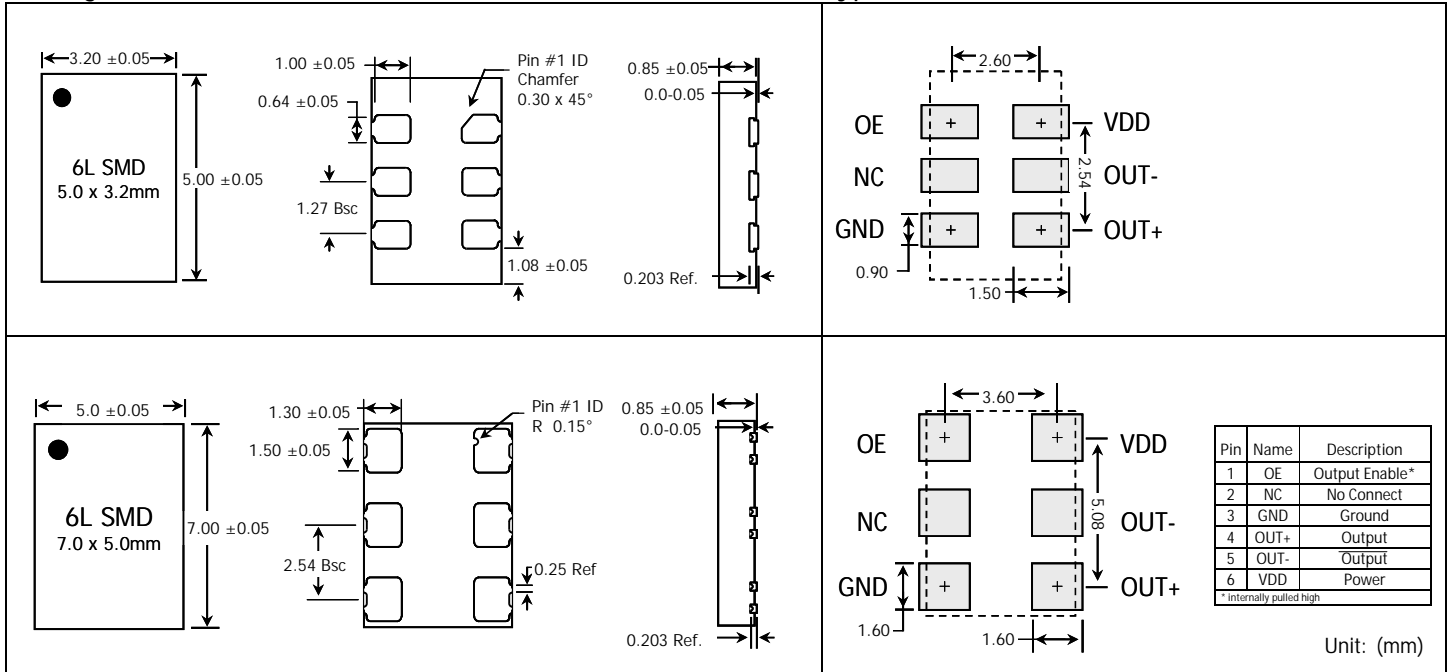

Pin	Name	Description
1	OE	Output Enable*
2	NC	No Connect
3	GND	Ground
4	OUT+	Output
5	OUT-	Output
6	VDD	Power

* Internally pulled high

Unit: (mm)



6024 Silver Creek Valley Road
San Jose, California 95138

Sales
+1 408-284-8200
Fax: 408-360-1738

Technical Support
MEMS_Support@idt.com
www.idt.com/go/MEMS

DISCLAIMER Integrated Device Technology, Inc. (IDT) and its subsidiaries reserve the right to modify the products and/or specifications described herein at any time and at IDT's sole discretion. All information in this document, including descriptions of product features and performance, is subject to change without notice. Performance specifications and the operating parameters of the described products are determined in the independent state and are not guaranteed to perform the same way when installed in customer products. The information contained herein is provided without representation or warranty of any kind, whether express or implied, including, but not limited to, the suitability of IDT's products for any particular purpose, an implied warranty of merchantability, or non-infringement of the intellectual property rights of others. This document is presented only as a guide and does not convey any license under intellectual property rights of IDT or any third parties.

IDT's products are not intended for use in life support systems or similar devices where the failure or malfunction of an IDT product can be reasonably expected to significantly affect the health or safety of users. Anyone using an IDT product in such a manner does so at their own risk, absent an express, written agreement by IDT.

Integrated Device Technology, IDT and the IDT logo are registered trademarks of IDT. Other trademarks and service marks used herein, including protected names, logos and designs, are the property of IDT or their respective third party owners.

Copyright 2010, 2011, 2012. All rights reserved.