

C3M0120090J

Silicon Carbide Power MOSFET

C3M™ MOSFET Technology

N-Channel Enhancement Mode

V_{DS}	900 V
$I_D @ 25^\circ\text{C}$	22 A
$R_{DS(on)}$	120 mΩ

Features

- New C3M SiC MOSFET technology
- High blocking voltage with low On-resistance
- High speed switching with low capacitances
- New low impedance package with driver source
- Fast intrinsic diode with low reverse recovery (Qrr)
- Halogen free, RoHS compliant
- Wide creepage (~7mm) between drain and source

Benefits

- Higher system efficiency
- Reduced cooling requirements
- Increased power density
- Increased system switching frequency

Applications

- Renewable energy
- EV battery chargers
- High voltage DC/DC converters
- Switch Mode Power Supplies
- Lighting

Package

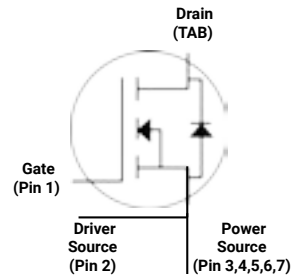

Part Number	Package
C3M0120090J	TO-263-7

Maximum Ratings ($T_c = 25^\circ\text{C}$ unless otherwise specified)

Symbol	Parameter	Value	Unit	Test Conditions	Note
V_{DSmax}	Drain - Source Voltage	900	V	$V_{GS} = 0\text{ V}, I_D = 100\ \mu\text{A}$	
V_{GSmax}	Gate - Source Voltage	-8/+18	V	Absolute maximum values	
V_{GSop}	Gate - Source Voltage	-4/+15	V	Recommended operational values	Note (1)
I_D	Continuous Drain Current	22	A	$V_{GS} = 15\text{ V}, T_c = 25^\circ\text{C}$	Fig. 19
		14		$V_{GS} = 15\text{ V}, T_c = 100^\circ\text{C}$	
$I_{D(pulse)}$	Pulsed Drain Current	50	A	Pulse width t_p limited by T_{Jmax}	Fig. 22
P_D	Power Dissipation	83	W	$T_c = 25^\circ\text{C}, T_J = 150^\circ\text{C}$	Fig. 20
T_J, T_{stg}	Operating Junction and Storage Temperature	-55 to +150	$^\circ\text{C}$		
T_L	Solder Temperature	260	$^\circ\text{C}$	1.6mm (0.063") from case for 10s	

Note (1): MOSFET can also safely operate at 0/+15 V

Symbol	Parameter	Min.	Typ.	Max.	Unit	Test Conditions	Note
$V_{(BR)DSS}$	Drain-Source Breakdown Voltage	900			V	$V_{GS} = 0\text{ V}, I_D = 100\ \mu\text{A}$	
$V_{GS(th)}$	Gate Threshold Voltage	1.8	2.1	3.5	V	$V_{DS} = V_{GS}, I_D = 3\ \text{mA}$	Fig. 11
			1.6		V	$V_{DS} = V_{GS}, I_D = 3\ \text{mA}, T_J = 150^\circ\text{C}$	
I_{DSS}	Zero Gate Voltage Drain Current		1	100	μA	$V_{DS} = 900\ \text{V}, V_{GS} = 0\ \text{V}$	
I_{GSS}	Gate-Source Leakage Current		10	250	nA	$V_{GS} = 15\ \text{V}, V_{DS} = 0\ \text{V}$	
$R_{DS(on)}$	Drain-Source On-State Resistance		120	155	m Ω	$V_{GS} = 15\ \text{V}, I_D = 15\ \text{A}$	Fig. 4, 5, 6
			170			$V_{GS} = 15\ \text{V}, I_D = 15\ \text{A}, T_J = 150^\circ\text{C}$	
g_{fs}	Transconductance		7.7		S	$V_{DS} = 15\ \text{V}, I_{DS} = 15\ \text{A}$	Fig. 7
			6.7			$V_{DS} = 15\ \text{V}, I_{DS} = 15\ \text{A}, T_J = 150^\circ\text{C}$	
C_{iss}	Input Capacitance		350		pF	$V_{GS} = 0\ \text{V}, V_{DS} = 600\ \text{V}$ $f = 1\ \text{MHz}$ $V_{AC} = 25\ \text{mV}$	Fig. 17, 18
C_{oss}	Output Capacitance		40				
C_{rss}	Reverse Transfer Capacitance		3				
E_{oss}	C_{oss} Stored Energy		9		μJ		Fig. 16
E_{ON}	Turn-On Switching Energy		49		μJ	$V_{DS} = 400\ \text{V}, V_{GS} = -4\ \text{V}/15\ \text{V}, I_D = 15\ \text{A},$ $R_{G(ext)} = 2.5\ \Omega, L = 142\ \mu\text{H}, T_J = 150^\circ\text{C}$	Fig. 26, 29
E_{OFF}	Turn Off Switching Energy		16				
$t_{d(on)}$	Turn-On Delay Time		12.5		ns	$V_{DD} = 400\ \text{V}, V_{GS} = -4\ \text{V}/15\ \text{V}$ $I_D = 15\ \text{A}, R_{G(ext)} = 2.5\ \Omega,$ Timing relative to V_{DS} Inductive load	Fig. 27, 29
t_r	Rise Time		9				
$t_{d(off)}$	Turn-Off Delay Time		15				
t_f	Fall Time		5				
$R_{G(int)}$	Internal Gate Resistance		16		Ω	$f = 1\ \text{MHz}, V_{AC} = 25\ \text{mV}$	
Q_{gs}	Gate to Source Charge		4.8		nC	$V_{DS} = 400\ \text{V}, V_{GS} = -4\ \text{V}/15\ \text{V}$ $I_D = 15\ \text{A}$ Per IEC60747-8-4 pg 21	Fig. 12
Q_{gd}	Gate to Drain Charge		5.0				
Q_g	Total Gate Charge		17.3				

Reverse Diode Characteristics ($T_c = 25^\circ\text{C}$ unless otherwise specified)

Symbol	Parameter	Typ.	Max.	Unit	Test Conditions	Note
V_{SD}	Diode Forward Voltage	4.8		V	$V_{GS} = -4\ \text{V}, I_{SD} = 7.5\ \text{A}$	Fig. 8, 9, 10
		4.4		V	$V_{GS} = -4\ \text{V}, I_{SD} = 7.5\ \text{A}, T_J = 150^\circ\text{C}$	
I_S	Continuous Diode Forward Current		17	A	$V_{GS} = -4\ \text{V}$	Note (2)
$I_{S,pulse}$	Diode pulse Current		50	A	$V_{GS} = -4\ \text{V}$, pulse width t_p limited by T_{jmax}	Note (2)
t_{rr}	Reverse Recover time	24		ns	$V_{GS} = -4\ \text{V}, I_{SD} = 15\ \text{A}, V_R = 400\ \text{V}$ $\text{dif}/\text{dt} = 900\ \text{A}/\mu\text{s}, T_J = 150^\circ\text{C}$	Note (2)
Q_{rr}	Reverse Recovery Charge	115		nC		
I_{rrm}	Peak Reverse Recovery Current	6.2		A		

 Note (2): When using SiC Body Diode the maximum recommended $V_{GS} = -4\text{V}$
Thermal Characteristics

Symbol	Parameter	Max.	Unit	Test Conditions	Note
$R_{\theta JC}$	Thermal Resistance from Junction to Case	1.5	$^\circ\text{C}/\text{W}$		Fig. 21
$R_{\theta JA}$	Thermal Resistance From Junction to Ambient	40			

Typical Performance

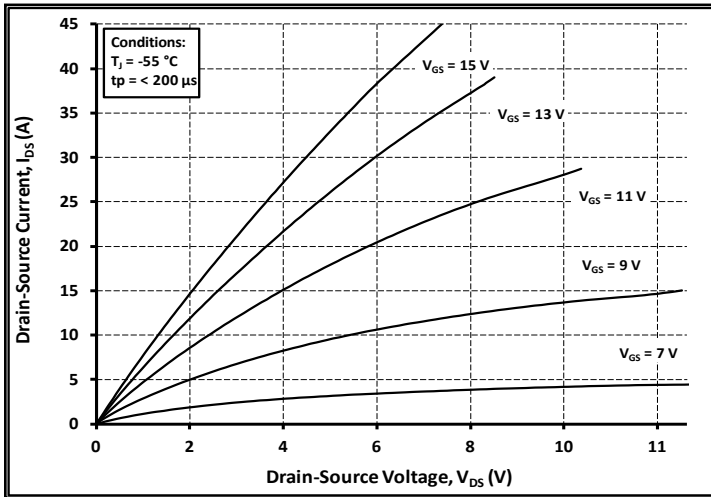

Figure 1. Output Characteristics $T_J = -55\text{ }^\circ\text{C}$

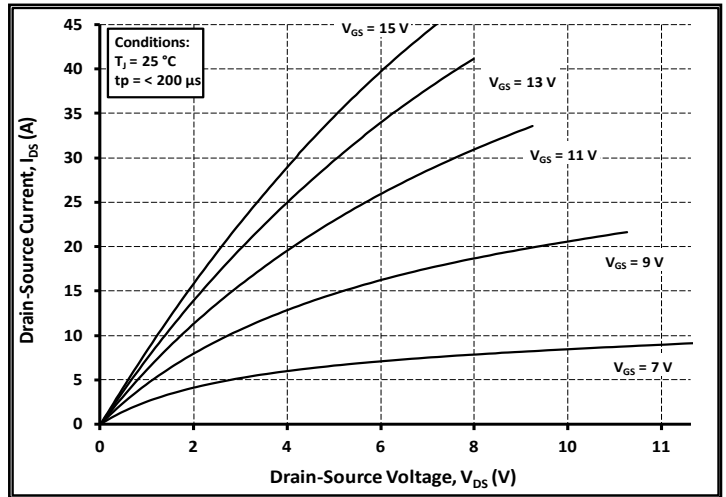

Figure 2. Output Characteristics $T_J = 25\text{ }^\circ\text{C}$

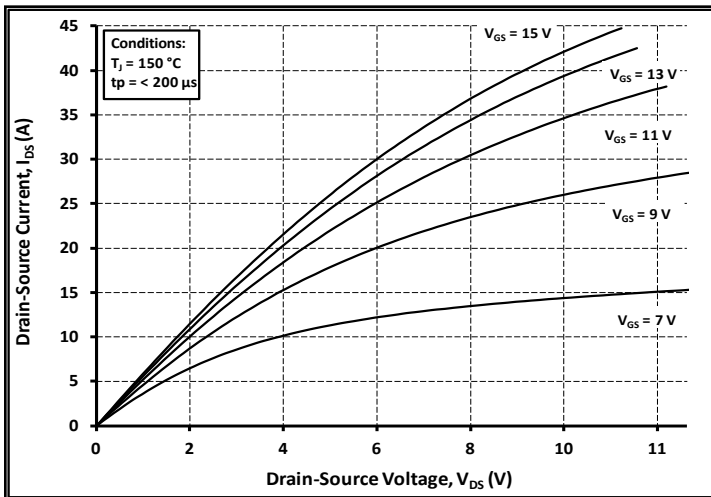

Figure 3. Output Characteristics $T_J = 150\text{ }^\circ\text{C}$

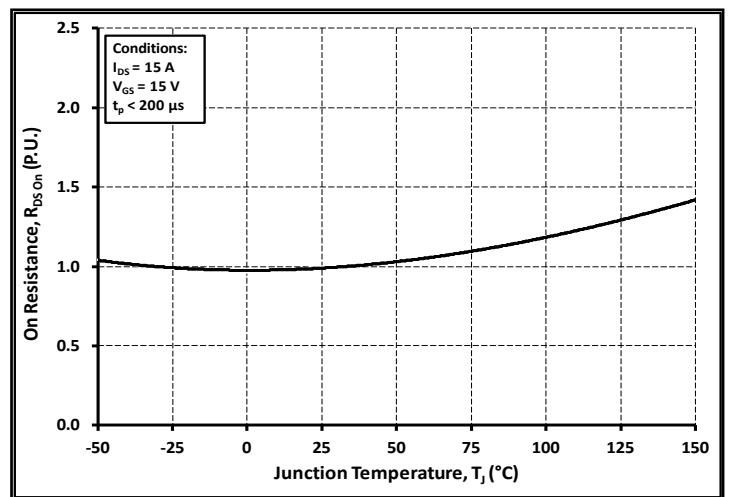

Figure 4. Normalized On-Resistance vs. Temperature

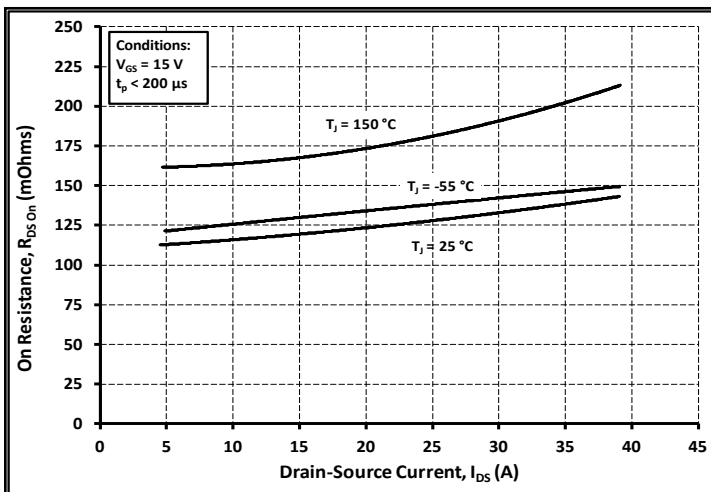

Figure 5. On-Resistance vs. Drain Current For Various Temperatures

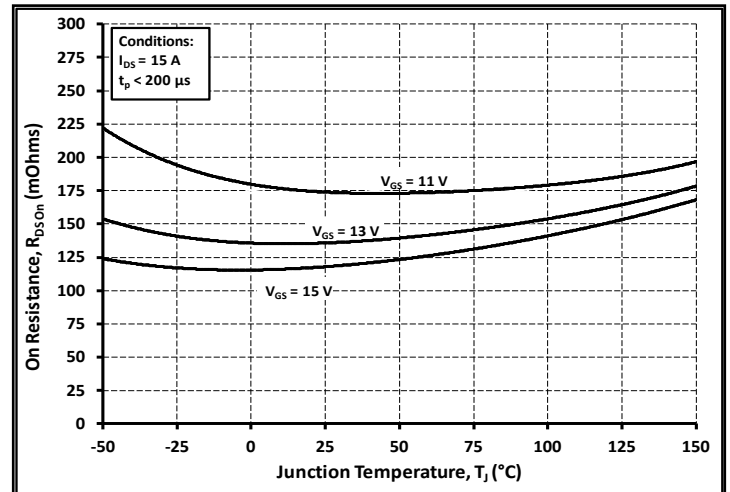

Figure 6. On-Resistance vs. Temperature For Various Gate Voltage

Typical Performance

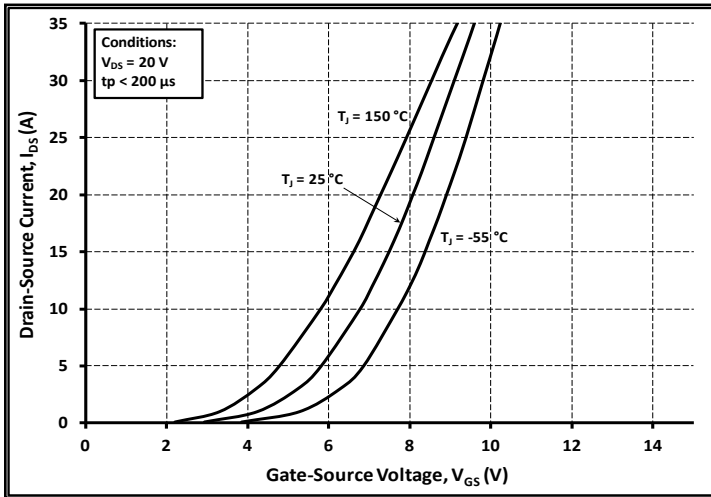

Figure 7. Transfer Characteristic for Various Junction Temperatures

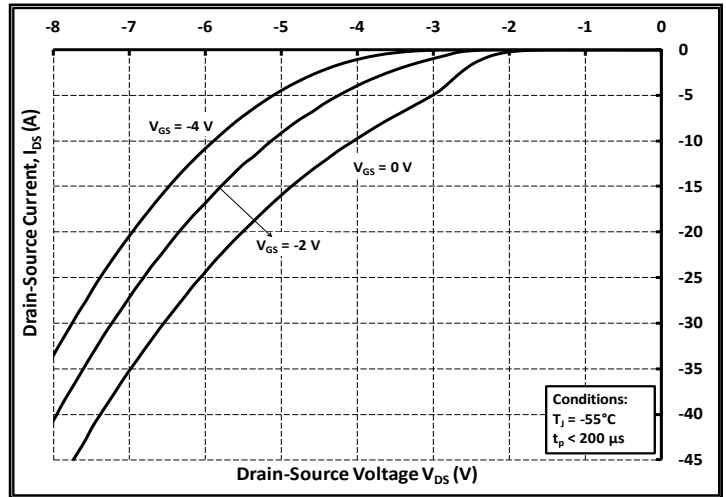

Figure 8. Body Diode Characteristic at $-55\text{ }^\circ\text{C}$

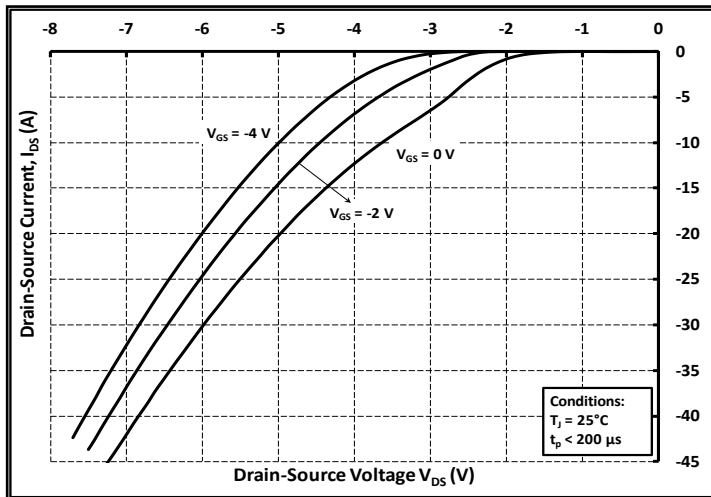

Figure 9. Body Diode Characteristic at $25\text{ }^\circ\text{C}$

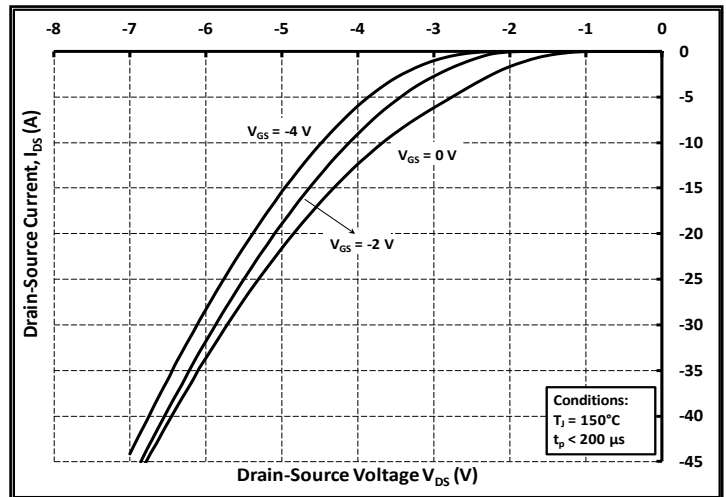

Figure 10. Body Diode Characteristic at $150\text{ }^\circ\text{C}$

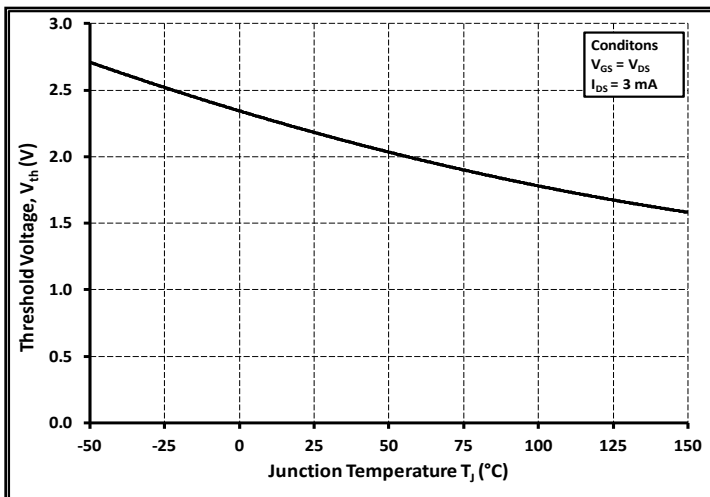

Figure 11. Threshold Voltage vs. Temperature

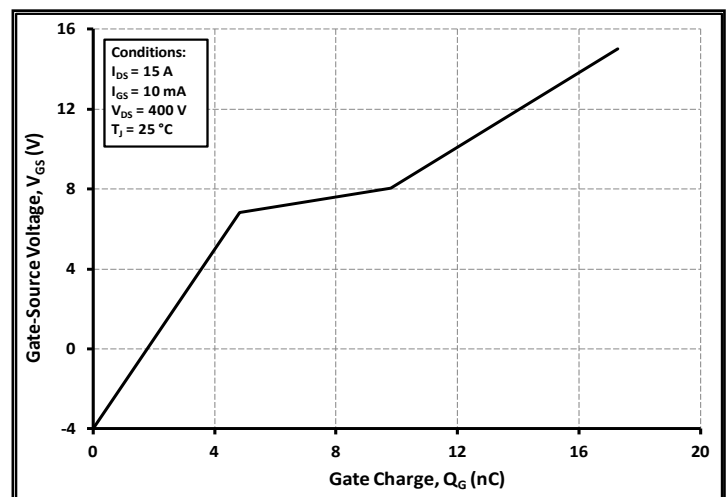

Figure 12. Gate Charge Characteristics

Typical Performance

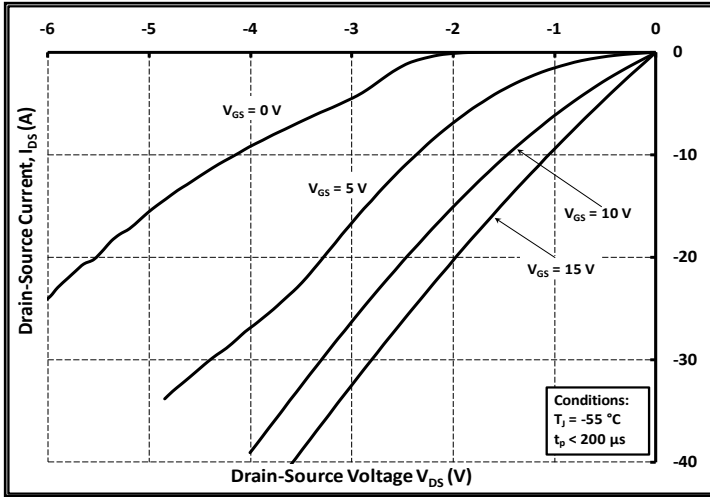

Figure 13. 3rd Quadrant Characteristic at -55°C

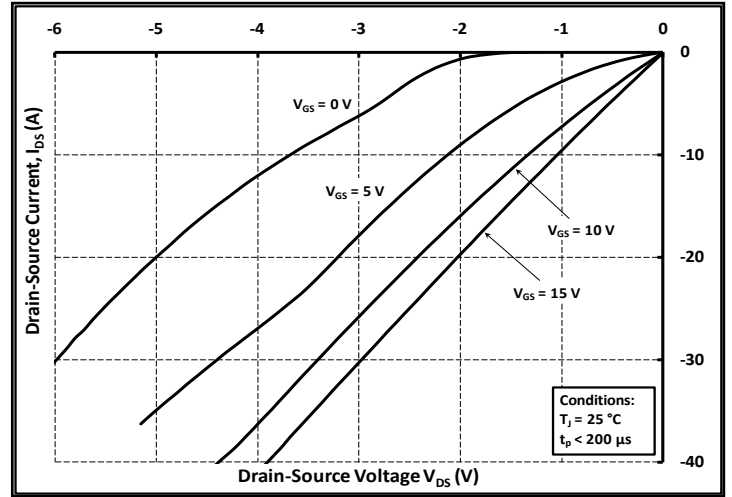

Figure 14. 3rd Quadrant Characteristic at 25°C

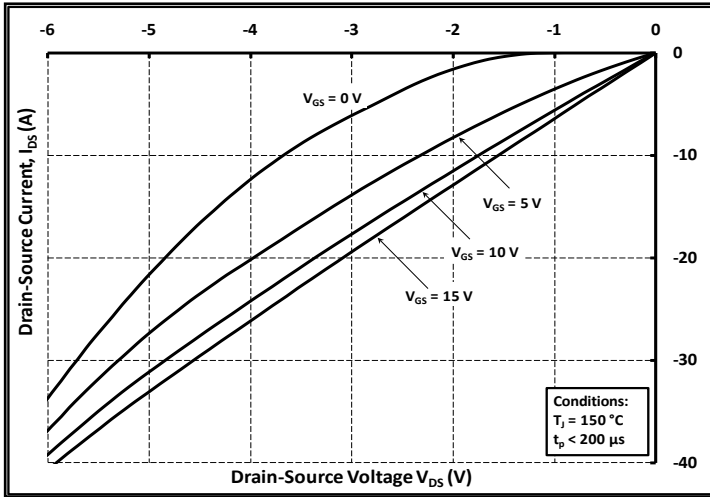

Figure 15. 3rd Quadrant Characteristic at 150°C

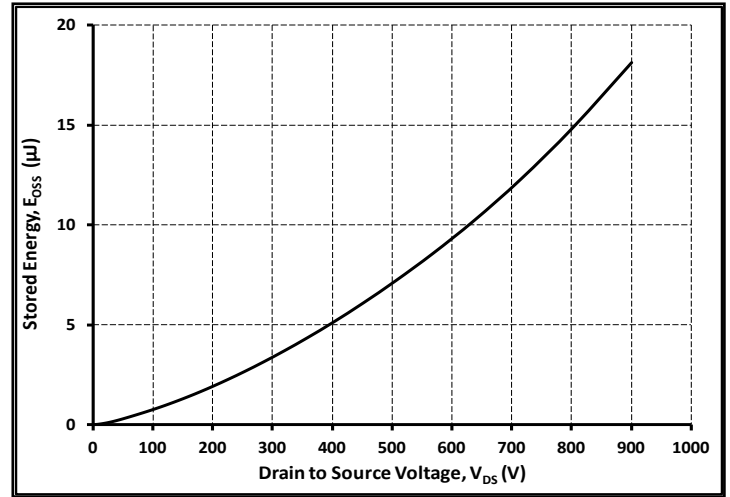

Figure 16. Output Capacitor Stored Energy

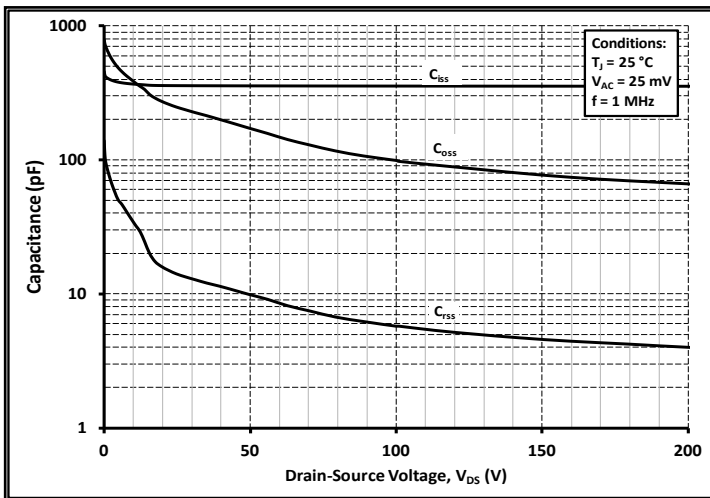

Figure 17. Capacitances vs. Drain-Source Voltage (0 - 200V)

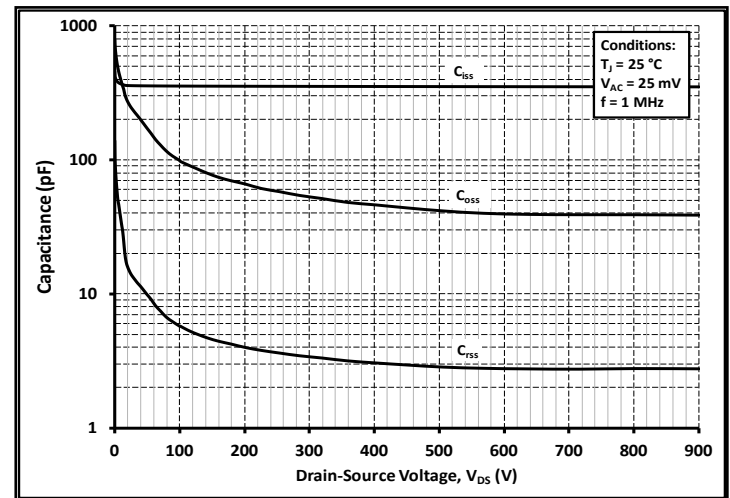

Figure 18. Capacitances vs. Drain-Source Voltage (0 - 900V)

Typical Performance

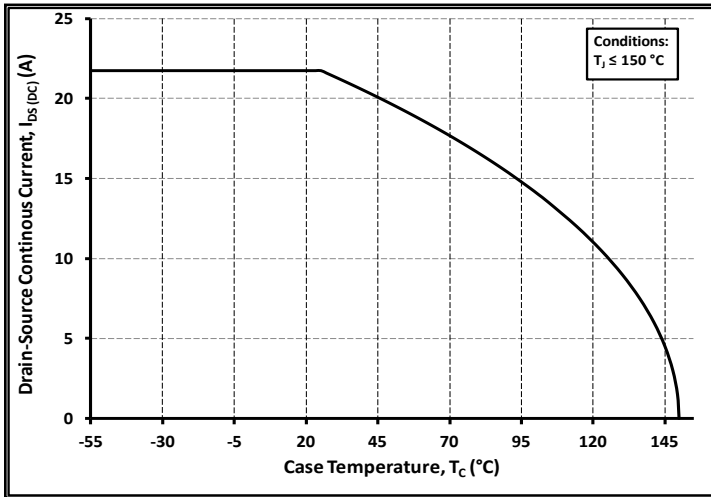

Figure 19. Continuous Drain Current Derating vs. Case Temperature

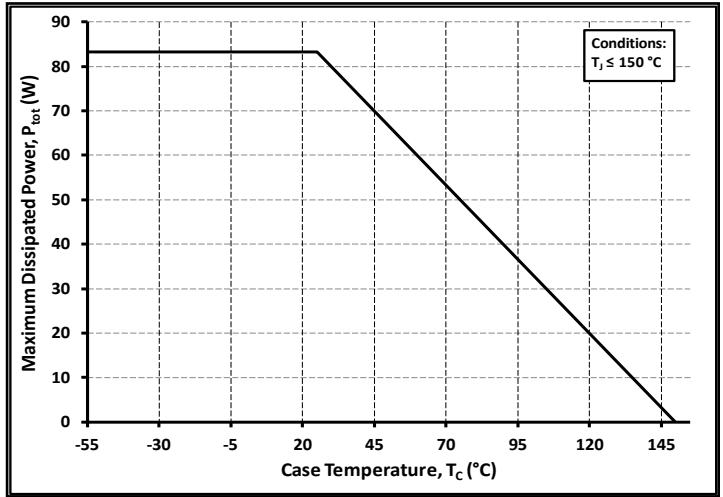

Figure 20. Maximum Power Dissipation Derating vs. Case Temperature

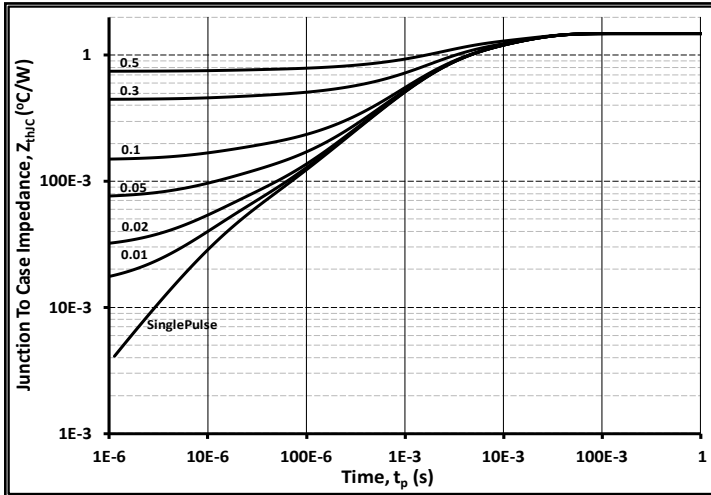

Figure 21. Transient Thermal Impedance (Junction - Case)

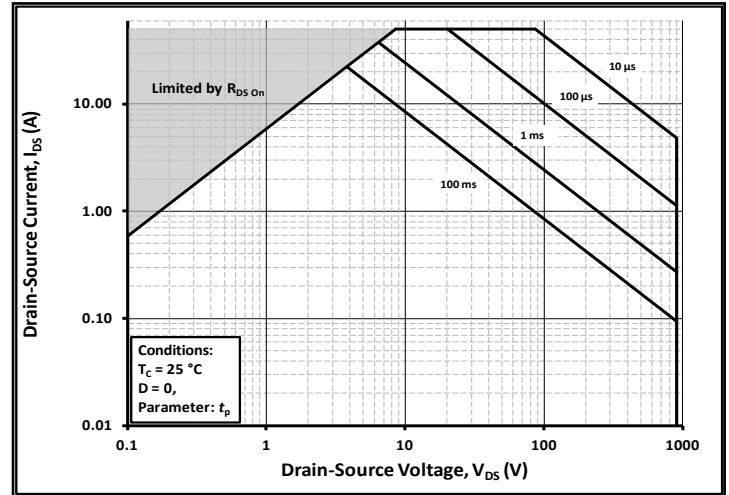

Figure 22. Safe Operating Area

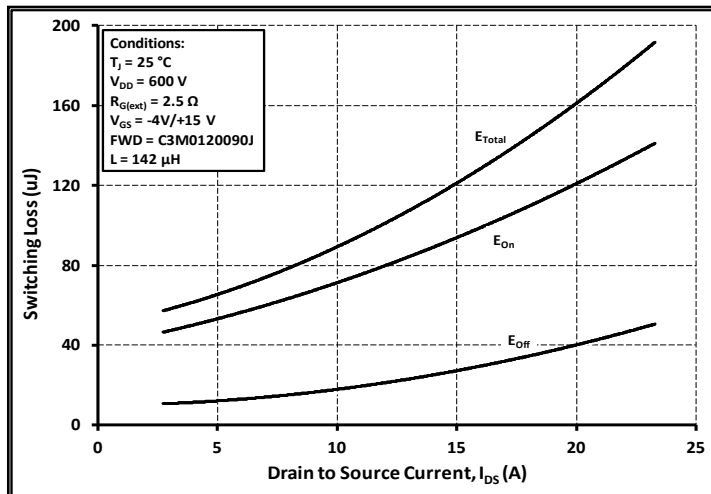

Figure 23. Clamped Inductive Switching Energy vs. Drain Current ($V_{DD} = 600V$)

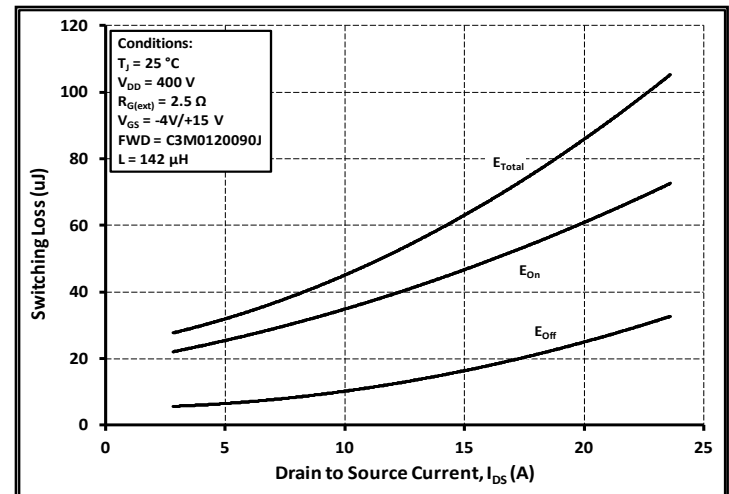

Figure 24. Clamped Inductive Switching Energy vs. Drain Current ($V_{DD} = 400V$)

Typical Performance

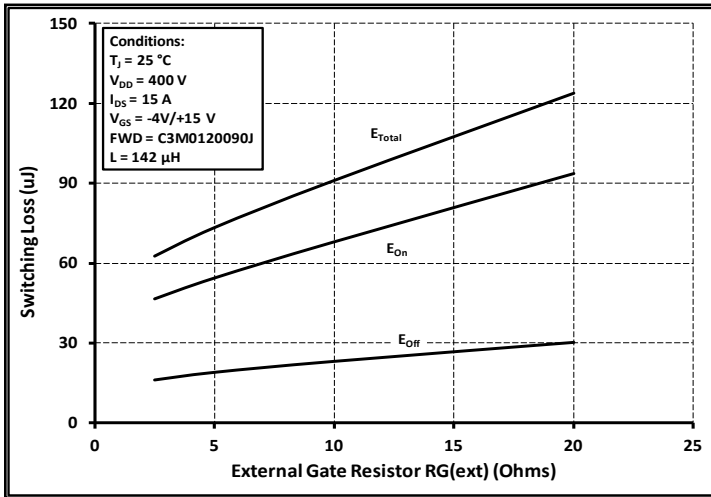

Figure 25. Clamped Inductive Switching Energy vs. $R_{G(ext)}$

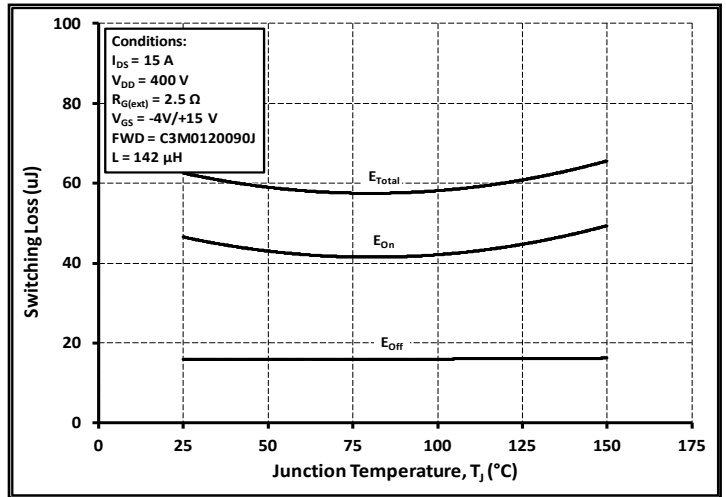

Figure 26. Clamped Inductive Switching Energy vs. Temperature

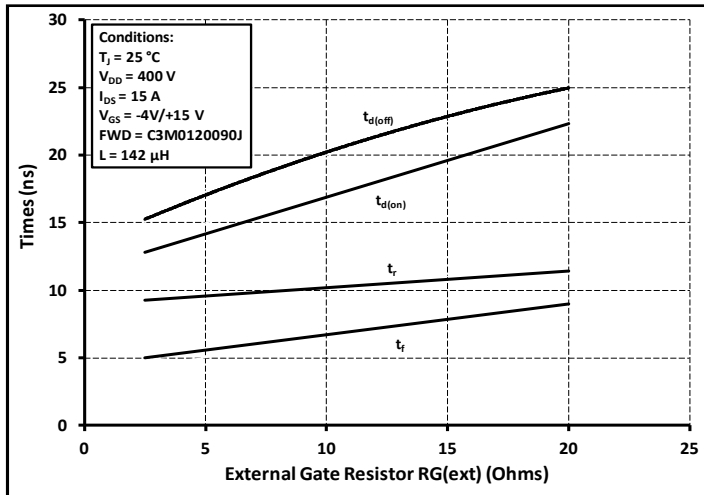

Figure 27. Switching Times vs. $R_{G(ext)}$

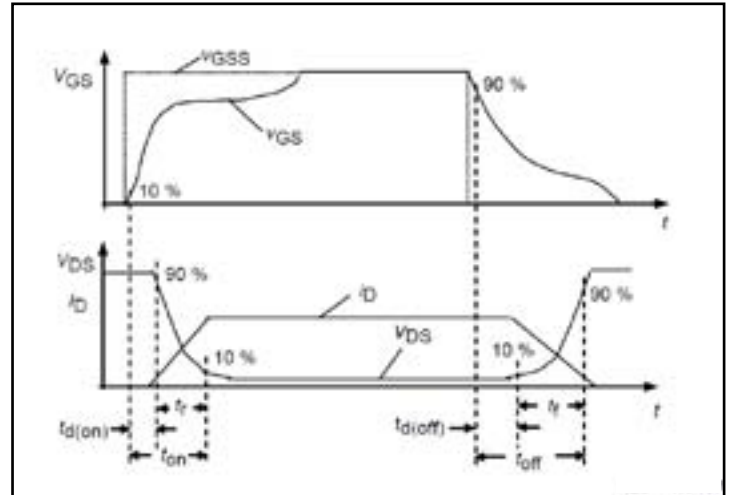

Figure 28. Switching Times Definition

Test Circuit Schematic

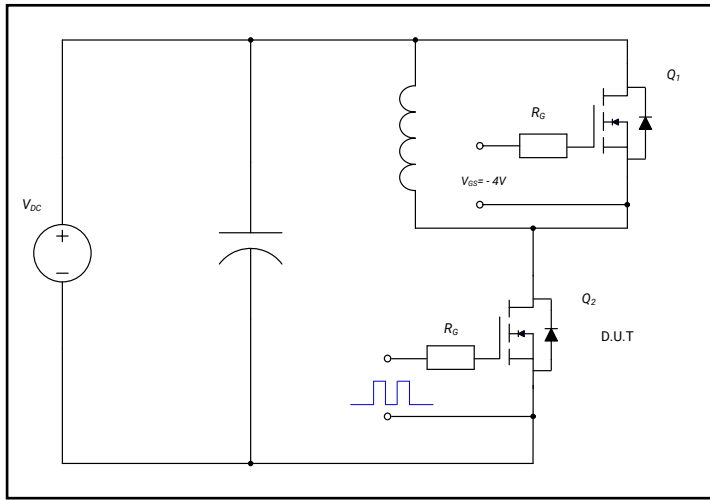
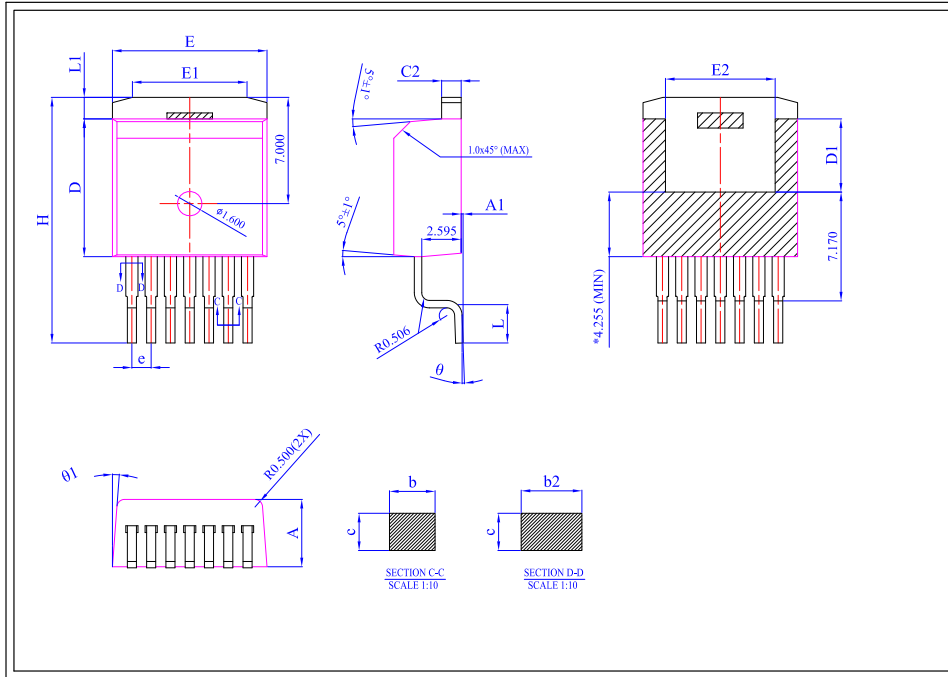

Figure 29. Clamped Inductive Switching Test Circuit

Note (3): Turn-off and Turn-on switching energy and timing values measured using SiC MOSFET Body Diode as shown above.

Package Dimensions

TO-263-7



Dim	All Dimensions in Millimeters		
	Min	typ	Max
A	4.300	4.435	4.570
A1	0.00	0.125	0.25
b	0.500	0.600	0.700
b2	0.600	0.800	1.000
c	0.330	0.490	0.650
C2	1.170	1.285	1.400
D	9.025	9.075	9.125
D1	4.700	4.800	4.900
E	10.130	10.180	10.230
E1	6.500	7.550	8.600
E2	6.778	7.223	7.665
e	1.27		
H	15.043	16.178	17.313
L	2.324	2.512	2.700
L1	0.968	1.418	1.868
ϕ	0°	4°	8°
$\phi 1$	4.5°	5°	5.5°

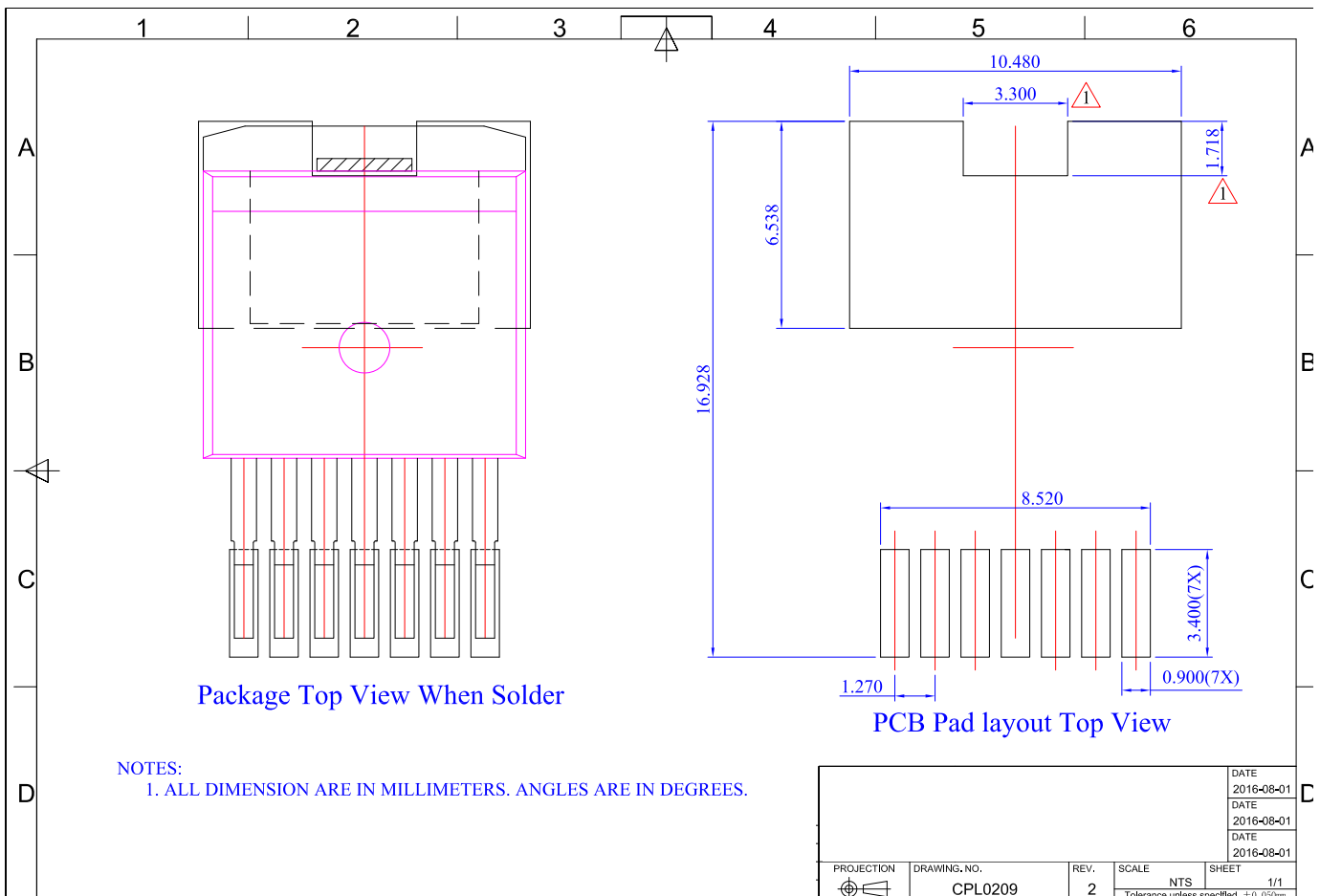

PROJECTION	DRAWING NO.	REV.	SCALE	SHEET	DATE
	CPL0209	2	NTS	1/1	2016-08-01
					DATE
					2016-08-01
					DATE
					2016-08-01
					DATE
					2016-08-01
					Tolerance unless specified $\pm 0.050mm$

Notes

- **RoHS Compliance**
The levels of RoHS restricted materials in this product are below the maximum concentration values (also referred to as the threshold limits) permitted for such substances, or are used in an exempted application, in accordance with EU Directive 2011/65/EC (RoHS2), as implemented January 2, 2013. RoHS Declarations for this product can be obtained from your Cree representative or from the Product Documentation sections of www.cree.com.
- **REACH Compliance**
REACH substances of high concern (SVHCs) information is available for this product. Since the European Chemical Agency (ECHA) has published notice of their intent to frequently revise the SVHC listing for the foreseeable future, please contact a Cree representative to insure you get the most up-to-date REACH SVHC Declaration. REACH banned substance information (REACH Article 67) is also available upon request.
- This product has not been designed or tested for use in, and is not intended for use in, applications implanted into the human body nor in applications in which failure of the product could lead to death, personal injury or property damage, including but not limited to equipment used in the operation of nuclear facilities, life-support machines, cardiac defibrillators or similar emergency medical equipment, aircraft navigation or communication or control systems, air traffic control systems.

Related Links

- **C2M PSPICE Models:** <http://wolfspeed.com/power/tools-and-support>
- **SiC MOSFET Isolated Gate Driver reference design:** <http://wolfspeed.com/power/tools-and-support>
- **SiC MOSFET Evaluation Board:** <http://wolfspeed.com/power/tools-and-support>