

### Multilayer Varistor for ESD pulse

Series **EZJZ** : For high speed signal line  
(ZnO:Zinc Oxide) (Small capacitance)

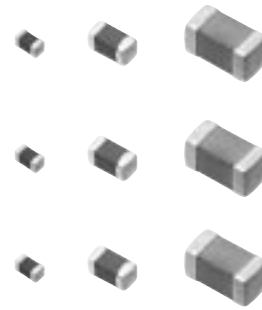

#### ■ Features

- Multilayer monolithic ceramic construction
- Excellent solderability and superior heat resistance
- Large surge current and energy capabilities in withstanding small size.

#### ● Series EZJZ

- Multilayer varistor of Zinc oxide ceramic. suppresses the pulse noise(ESD, burst-noise) and protects the equipment from the transient surge.
- This Varistor is suitable for high-speed signal line due to small capacitance.

#### ■ Precautions for Handling see Page 112 to 118

#### ■ Packing method see Page 111, 182

#### ■ Explanation of Part Numbers

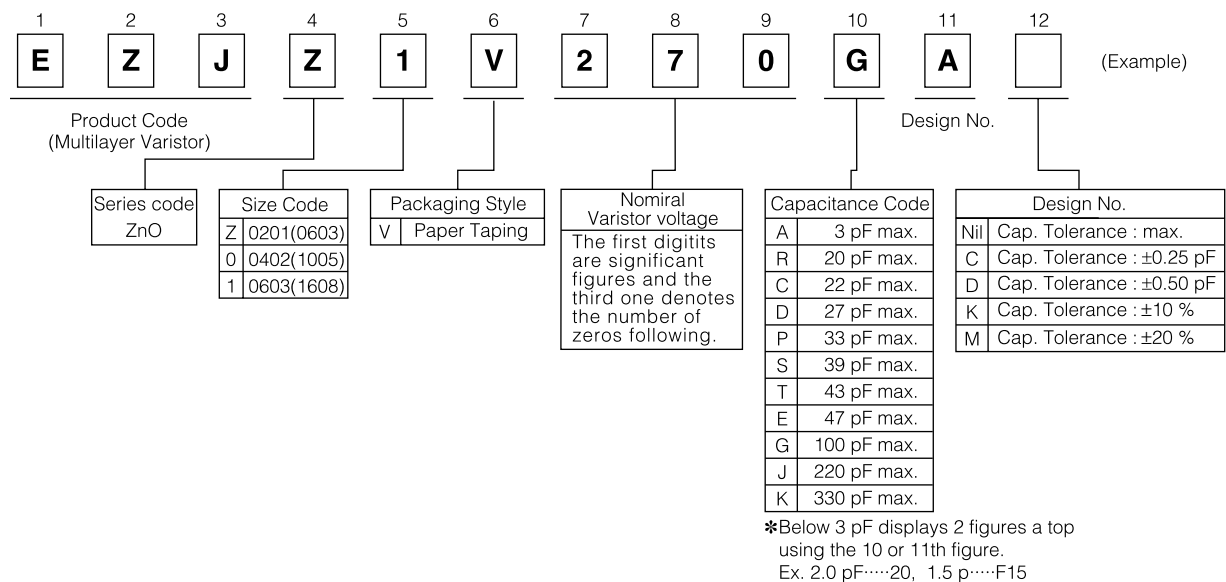

#### ■ Construction

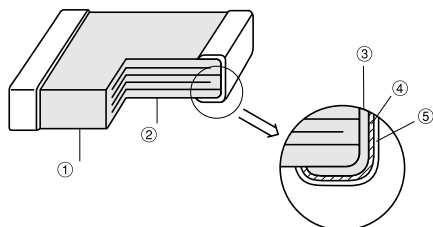

No	Name	
①	Semiconductive Ceramics	
②	Inner electrode	
③	Electrode	Substrate electrode
④		Intermediate electrode
⑤		External electrode

■ Dimension in mm(not to scale)

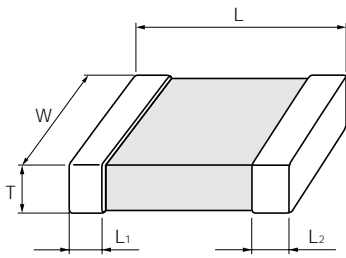

(Unit:mm)

Size Code (EIA)	Part Numbers	L	W	T	L1, L2
0201	EZJZ□□□□□A	0.60±0.03	0.30±0.03	0.30±0.03	0.15±0.05
0402	EZJZ0□□□□□A	1.00±0.50	0.50±0.05	0.50±0.05	0.2±0.1
0603	EZJZ1□□□□□A	1.6±0.1	0.8±0.1	0.8±0.1	0.3±0.2

■ Ratings and Characteristics

Type	Size Code (EIA)	Part No.	Maximum Allowable Voltage	Varistor Voltage @ 1mA	Capacitance @ 1 MHz	Maximum Peak Current @ 8/20 μs	Maximum ESD IEC61000-4-2
Ultra low capacitance	0201	EZJZV800AA	DC 5 V	80 V	3 pF max.	—	Contact Discharge Voltage: 8 kV Air Gap Discharge Voltage: 15 kV
		EZJZ0V80015D	DC 5 V	80 V	1.5±0.5 pF	—	
	0402	EZJZ0V500AA	DC 5 V	50 V	3 pF max.	—	
		EZJZ0V800AA	DC 18 V	80 V	3 pF max.	—	
		EZJZ0V171AA	DC 18 V	170 V	3 pF max.	—	
	0603	EZJZ1V500AA	DC 5 V	50 V	3 pF max.	—	
		EZJZ1V800AA	DC 18 V	80 V	3 pF max.	—	
EZJZ1V171AA		DC 18 V	170 V	3 pF max.	—		
Low capacitance	0201	EZJZV120EA	DC 6.7 V	12 V	47 pF max.	1 A	
		EZJZV270RA	DC 16 V	27 V	20 pF max.	1 A	
	0402	EZJZ0V120JA	DC 6.7 V	12 V	220 pF max.	10 A	
		EZJZ0V270RA	DC 16 V	27 V	20 pF max.	3 A	
		EZJZ0V270EA	DC 16 V	27 V	47 pF max.	10 A	
	0603	EZJZ1V120KA	DC 6.7 V	12 V	330 pF max.	20 A	
		EZJZ1V270GA	DC 16 V	27 V	100 pF max.	20 A	
		EZJZ1V330GA	DC 26 V	33 V	100 pF max.	20 A	

● Operating Temperature Range: -40 to 85 °C

■ Typical Characteristics

● Voltage vs. Current

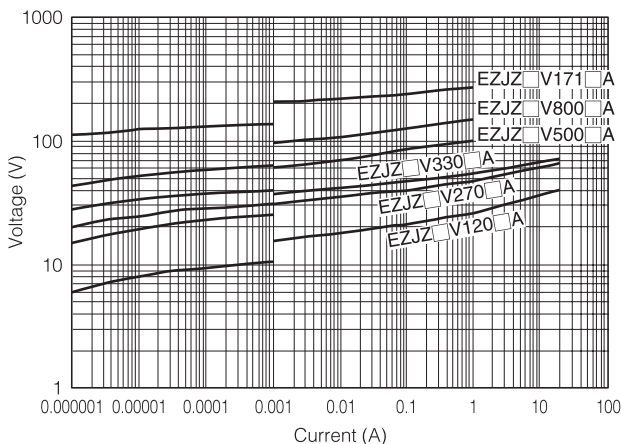

■ Frequency Characteristics

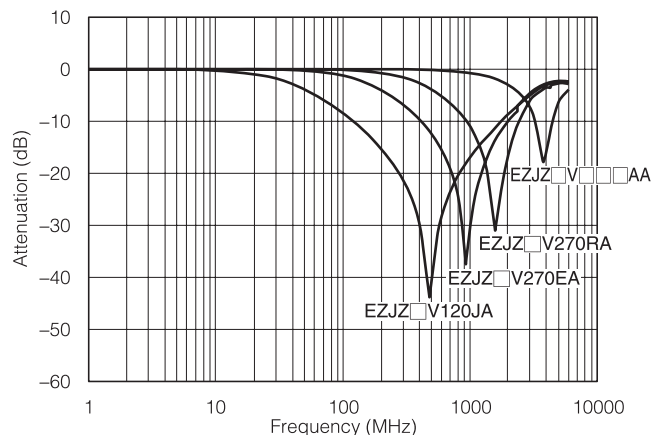

## ■ Packaging Specifications

### ● Standard Packing Quantity

Series	Size Code (EIA)	Thickness	Paper taping	Embossed taping
EZJZ	0201	0.3 mm	Pitch: 2 mm 15,000 pcs./reel	—
	0402	0.5 mm	Pitch: 2 mm 10,000 pcs./reel	—
	0603	0.8 mm	Pitch: 4 mm 4,000 pcs./reel	—
	2 Array Type	0.6 mm	Pitch: 4 mm 4,000 pcs./reel	—
	4 Array Type	0.85 mm	Pitch: 4 mm 4,000 pcs./reel	—
EZJS	0603	0.8 mm	Pitch: 4 mm 4,000 pcs./reel	—
	0805	0.8 mm	Pitch: 4 mm 5,000 pcs./reel	—
		1.25 mm	—	Pitch: 4 mm 2,000 pcs./reel

### ● Paper Taping

P<sub>1</sub>: 2mm

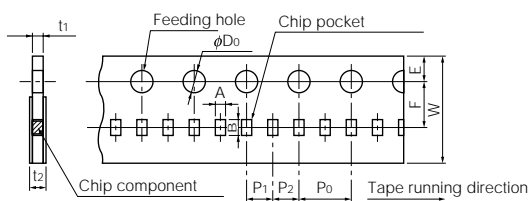

(Unit: mm)

Symbol	A	B	W	F	E	P <sub>1</sub>	P <sub>2</sub>	P <sub>0</sub>	φD	t <sub>1</sub>	t <sub>2</sub>
0201	0.37 ±0.03	0.67 ±0.03	8.0 ±0.2	3.50 ±0.05	1.75 ±0.10	2.00 ±0.05	2.00 ±0.05	4.0 ±0.05	1.5 +0.1 0	0.5 max.	0.8 max.
0402	0.62 ±0.05	1.12 ±0.05	8.0 ±0.2	3.50 ±0.05	1.75 ±0.10	2.00 ±0.05	2.00 ±0.05	4.0 ±0.05	1.5 +0.1 0	0.7 max.	1.0 max.

P<sub>1</sub>: 4mm

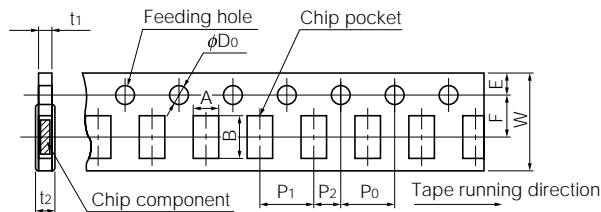

(Unit: mm)

Symbol	A	B	W	F	E	P <sub>1</sub>	P <sub>2</sub>	P <sub>0</sub>	φD	t <sub>1</sub>	t <sub>2</sub>
0603	1.18 ±0.10	1.63 ±0.10	8.0 ±0.2	3.50 ±0.05	1.75 ±0.10	4.0 ±0.1	2.00 ±0.05	4.0 ±0.1	1.5 +0.1 0	1.1 max.	1.4 max.
0805 4 Array Type	1.65 ±0.2	2.4 ±0.2	8.0 ±0.2	3.50 ±0.05	1.75 ±0.10	4.0 ±0.1	2.00 ±0.05	4.0 ±0.1	1.5 +0.1 0	1.1 max.	1.4 max.
0504 2 Array Type	1.0 ±0.1	1.8 ±0.1	8.0 ±0.2	3.50 ±0.05	1.75 ±0.10	4.0 ±0.1	2.00 ±0.05	4.0 ±0.1	1.5 +0.1 0	1.1 max.	1.4 max.

### ● Embossed Taping

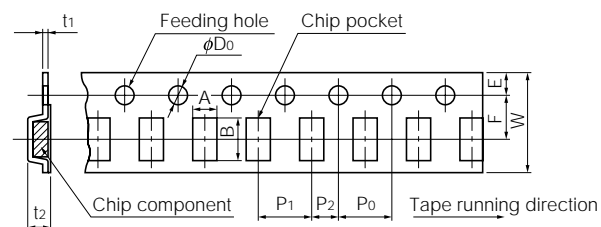

(Unit: mm)

Symbol	A	B	W	F	E	P <sub>1</sub>	P <sub>2</sub>	P <sub>0</sub>	φD	t <sub>1</sub>	t <sub>2</sub>
0805	1.55 ±0.20	2.35 ±0.20	8.0 ±0.2	3.50 ±0.05	1.75 ±0.10	4.0 ±0.1	2.00 ±0.05	4.0 ±0.1	1.5 +0.1 0	0.6 max.	1.5 max.

### ● Reel

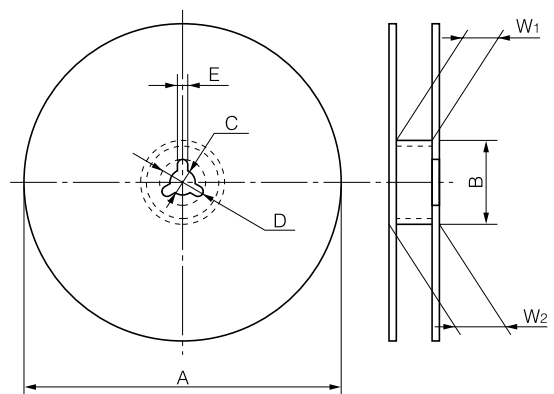

Symbol	A	B	C	D	E	W <sub>1</sub>	W <sub>2</sub>
Dim. (mm)	φ180 <sup>-0.1</sup>	φ60.0±0.5	13.0±0.5	21.0±0.8	2.0±0.5	9.0±0.3	11.4±1.00

### ● Leader Part and Taped End

Tape end

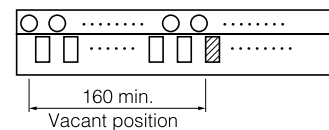

Leader part

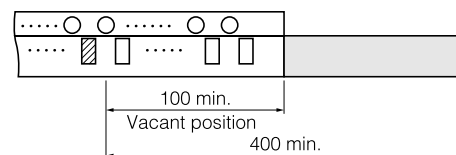

Unit : mm