

ACDBA2100-HF

Reverse Voltage: 100 Volts

Forward Current: 2.0 Amp

RoHS Device

Halogen free

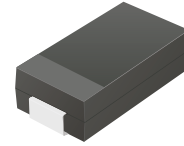

Features

- Low profile package.
- Ideal for automated placement.
- Guard Ring for over voltage protection.
- Low forward voltage drop.
- Comply with AEC-Q101

Mechanical data

- Case: DO-214AC / SMA, molded plastic.
- Epoxy: UL flammability classification rate 94V-0 .
- Terminals: Lead free plating (Tin finish).
Solderable per MIL-STD-202, Method 208.
- Polarity: Indicated by cathode band.
- Weight: 0.062 grams(approx.).

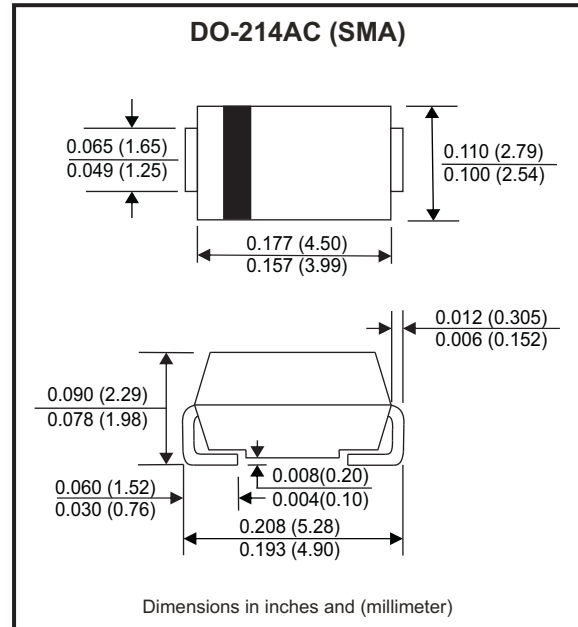

Circuit diagram



Maximum Ratings (at TA=25°C unless otherwise noted)

| Parameter | Conditions | Symbol | MIN. | TYP. | MAX. | Unit |
|-----------------------------------|--|-----------|------|------|------|------|
| Repetitive peak reverse voltage | | V_{RRM} | | | 100 | V |
| DC blocking voltage | | V_{DC} | | | 100 | V |
| RMS voltage | | V_{RMS} | | | 70 | V |
| Average forward rectified current | | I_F | | | 2 | A |
| Peak forward surge current | 8.3ms single half sine-wave superimposed on rate load (JEDEC method) | I_{FSM} | | | 50 | A |
| Operating Temperature range | | T_J | -55 | | +150 | °C |
| Storage temperature range | | T_{STG} | -55 | | +150 | °C |

Electrical Characteristics (at TA=25°C unless otherwise noted)

| Parameter | Conditions | Symbol | MIN. | TYP. | MAX. | Unit |
|-------------------------------|--|-----------------|------|------|------|------|
| Instantaneous forward voltage | $I_F = 2A, T_A = 25^\circ C$ | V_F | | | 0.85 | V |
| Reverse Current | $V_R = V_{RRM}, T_A = 25^\circ C$ | I_R | | | 0.2 | mA |
| | $V_R = V_{RRM}, T_A = 100^\circ C$ | I_R | | | 5.0 | mA |
| Junction capacitance (Note 1) | f=1MHz and applied 4V DC reverse Voltage | C_J | | 70 | | pF |
| Thermal Resistance | Junction to case | $R_{\theta JC}$ | | 40 | | °C/W |

Note: 1. Measured at 1.0MHZ and applied reverse voltage of 4.0V DC.

Company reserves the right to improve product design , functions and reliability without notice.

REV: A

Rating and Characteristics Curvers (ACDBA2100-HF)

Fig.1 - Typical Forward Current Derating Curve

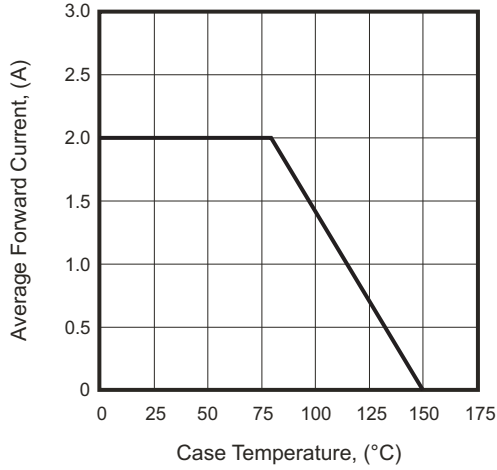

Fig.2 - Typical Forward Characteristics

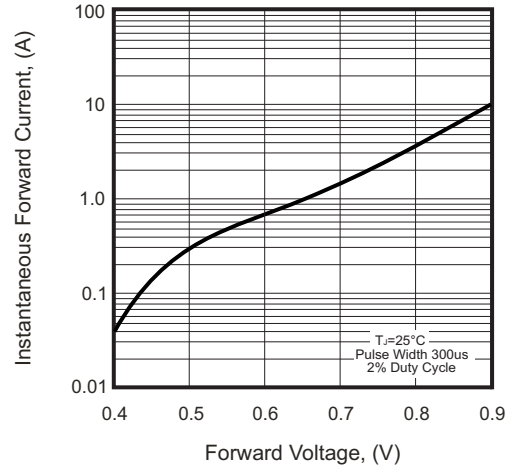

Fig.3 - Maximum Non-repetitive Forward Surge Current

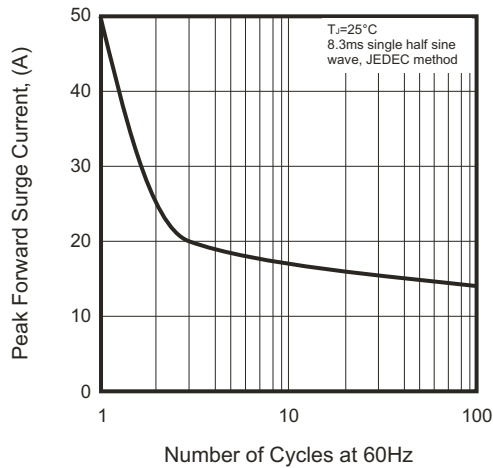

Fig.4 - Typical Reverse Characteristics

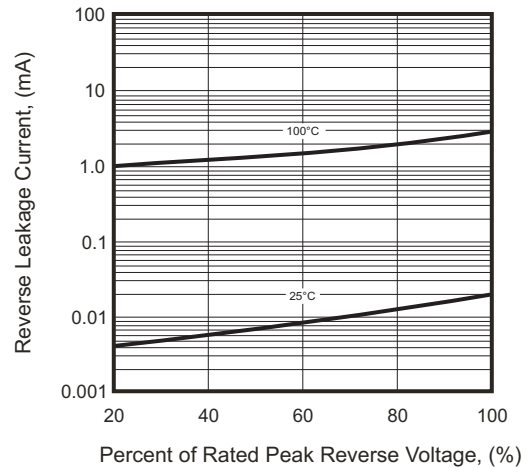
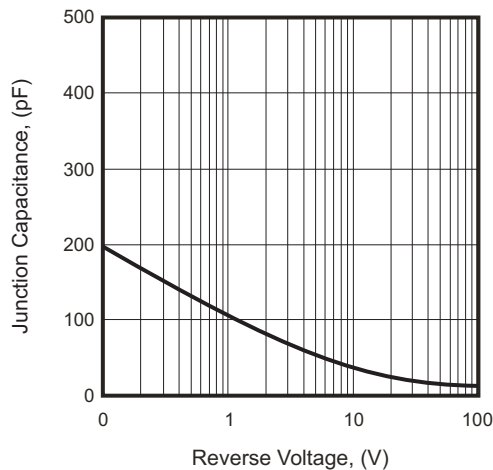

Fig.5 - Typical Junction Capacitance



Company reserves the right to improve product design , functions and reliability without notice.

Reel Taping Specification



| DO-214AC (SMA) | SYMBOL | A | B | C | d | D | D ₁ | D ₂ |
|-------------------|--------|------------|------------|------------|---------------|---------------|----------------|----------------|
| | (mm) | 2.90 MAX. | 5.90 MAX. | 2.66 MAX. | 1.50 ± 0.10 | 330 ± 2.00 | 50 MIN. | 13.50 ± 1.00 |
| | (inch) | 0.114 MAX. | 0.232 MAX. | 0.105 MAX. | 0.059 ± 0.004 | 13.00 ± 0.079 | 1.969 MIN. | 0.531 ± 0.039 |

| DO-214AC (SMA) | SYMBOL | E | F | P | P ₀ | P ₁ | W | W ₁ |
|-------------------|--------|---------------|---------------|---------------|----------------|----------------|---------------|----------------|
| | (mm) | 1.75 ± 0.10 | 5.50 ± 0.05 | 4.00 ± 0.10 | 4.00 ± 0.10 | 2.00 ± 0.05 | 12.00 ± 0.30 | 18.40 MAX. |
| | (inch) | 0.069 ± 0.004 | 0.217 ± 0.002 | 0.157 ± 0.004 | 0.157 ± 0.004 | 0.079 ± 0.002 | 0.472 ± 0.012 | 0.724 MAX. |

Company reserves the right to improve product design, functions and reliability without notice.

REV: A

Marking Code

| Part Number | Marking Code |
|--------------|--------------|
| ACDBA2100-HF | 2100 |



xxx = Product type marking code

Suggested PAD Layout

| SIZE | DO-214AC (SMA) | |
|------|----------------|--------|
| | (mm) | (inch) |
| A | 1.70 | 0.067 |
| B | 2.50 | 0.098 |
| C | 1.50 | 0.059 |
| D | 4.00 | 0.157 |
| E | 6.50 | 0.256 |

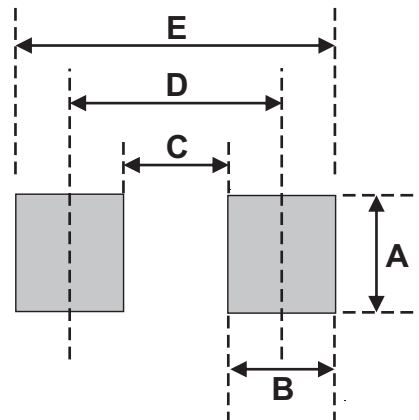

Note:

1. The pad layout is for reference purposes only.

Standard Packaging

| Case Type | REEL PACK | |
|----------------|--------------|------------------|
| | REEL (pcs) | Reel Size (inch) |
| DO-214AC (SMA) | 5,000 | 13 |