

## SPECIFICATION

Part No.	:	<b>DCP.5900.25.4.A.30</b>
Description	:	7dBi 5.9GHz 25mm DSRC / V2V / V2X / V2I PTFE HF Patch Antenna
Features	:	5850MHz to 5925MHz DSRC band For V2V and V2X Applications RHCP improves System Performance in different orientations Peak Gain 7dBi Pin Type PTFE HF PCB Antenna Dims: 25*25*4mm Tuned on 70*70mm ground plane <b>RoHS Compliant</b>



## 1. Introduction

The DCP.5900 is a 25\*25\*4mm embedded PTFE HF patch DSRC (Dedicated Short Range Communications) antenna. It is a high performance compact 7dBi directional antenna designed to operate at 5850-5925MHz for DSRC systems. The antenna has been designed to be circularly polarized to enable a more stable system signal strength on moving vehicles where orientation is constantly changing.

DSRC is the communications media of choice for active safety V2V/V2X (Vehicle-to-Vehicle and Vehicle-to-Other) systems. Primarily allocated for vehicle safety applications, DSRC supports high speed, low latency, short-range, V2V/V2X wireless communications. The DCP.5900 PTFEpatch antenna is mounted via pin and double-sided adhesive. The double-sided adhesive on the bottom of the patch helps to keep it in place while undergoing mounting. This antenna has been tuned for a center position on a 70\*70mm ground and features world leading efficiency at 78%, and an axial ratio of approximately 2dB.

For further optimization to customer specific device environments where positioning is off center or a different ground plane size is used, a custom tuned patch antenna can be supplied, subject to NRE and MOQ. Contact your regional Taoglas office for this and for support to integrate and test this antenna performance in your device.

## 2. Specification

ELECTRICAL		
Operation Frequency	5850MHz	5925MHz
Efficiency (%)	78.48	76.36
Peak Gain (dBi)	7.57	7.53
Average Gain (dB)	-1.05	-1.17
Axial Ratio (dB)	2.24	2.11
Return Loss	-22	-17
Antenna Polarization	RHCP	
Impedance	50Ω	
MECHANICAL		
PTFE HF Patch Dimension	25*25*4mm	
Pin Diameter	0.8mm	
Pin Length	3.0mm	
Weight	6.12g	
ENVIRONMENTAL		
Operation Temperature	-40°C to 85°C	
Storage Temperature	-40°C to 85°C	

\*All tests done on a 70\*70mm ground plane.

## 3. Antenna Characteristics

### 3.1 Test Setup

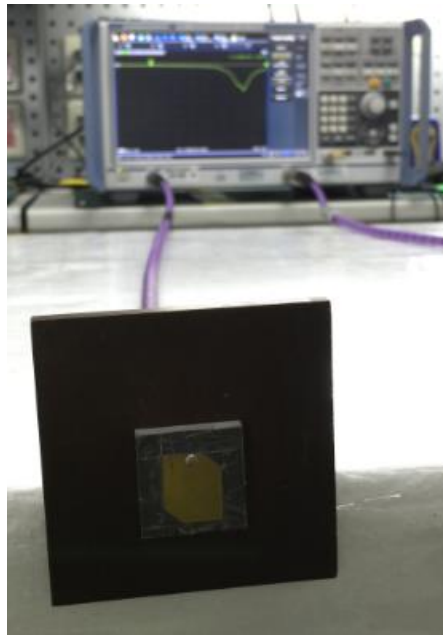

### 3.2 Return Loss

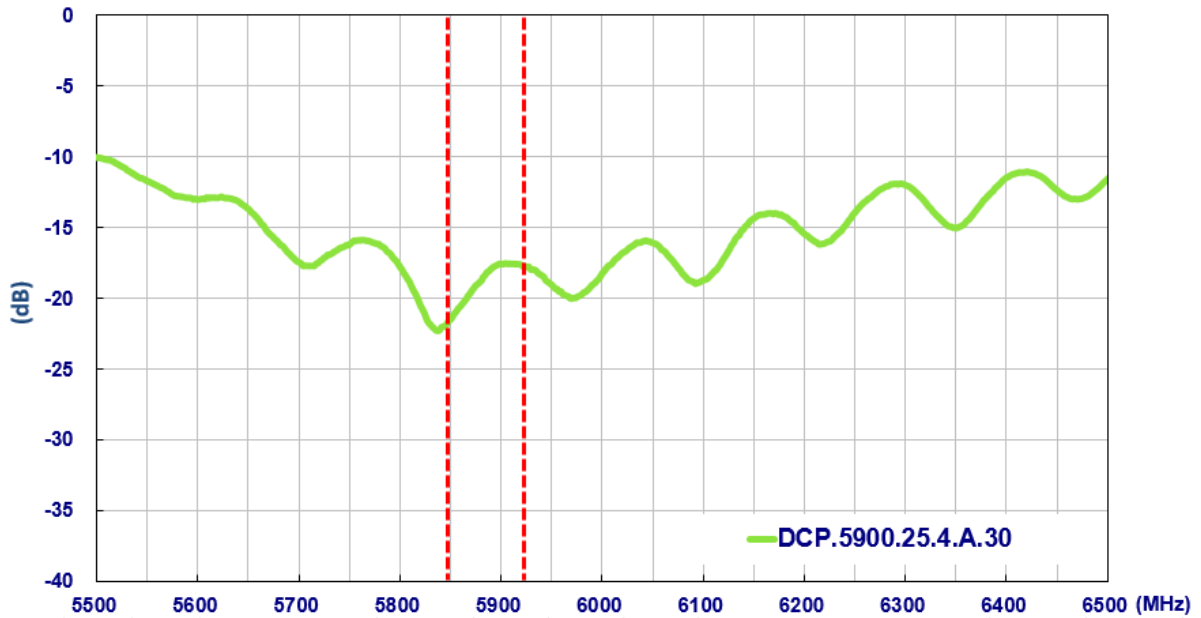

### 3.3 Efficiency

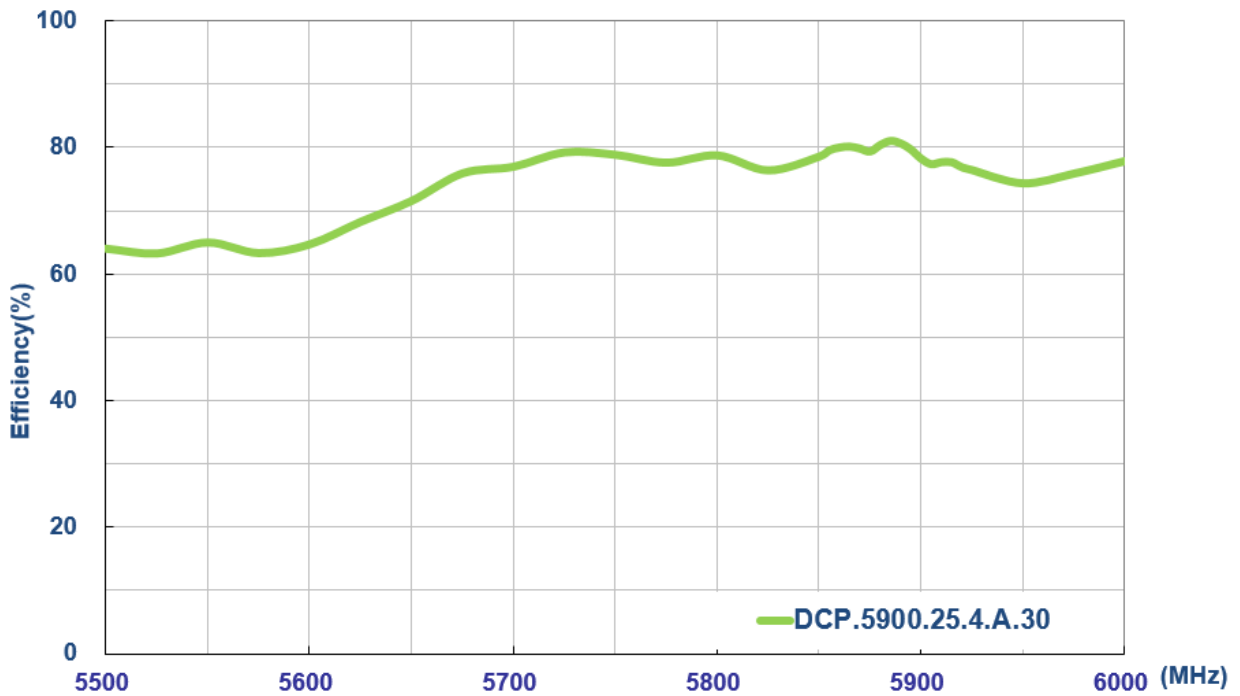

### 3.4 Average Gain

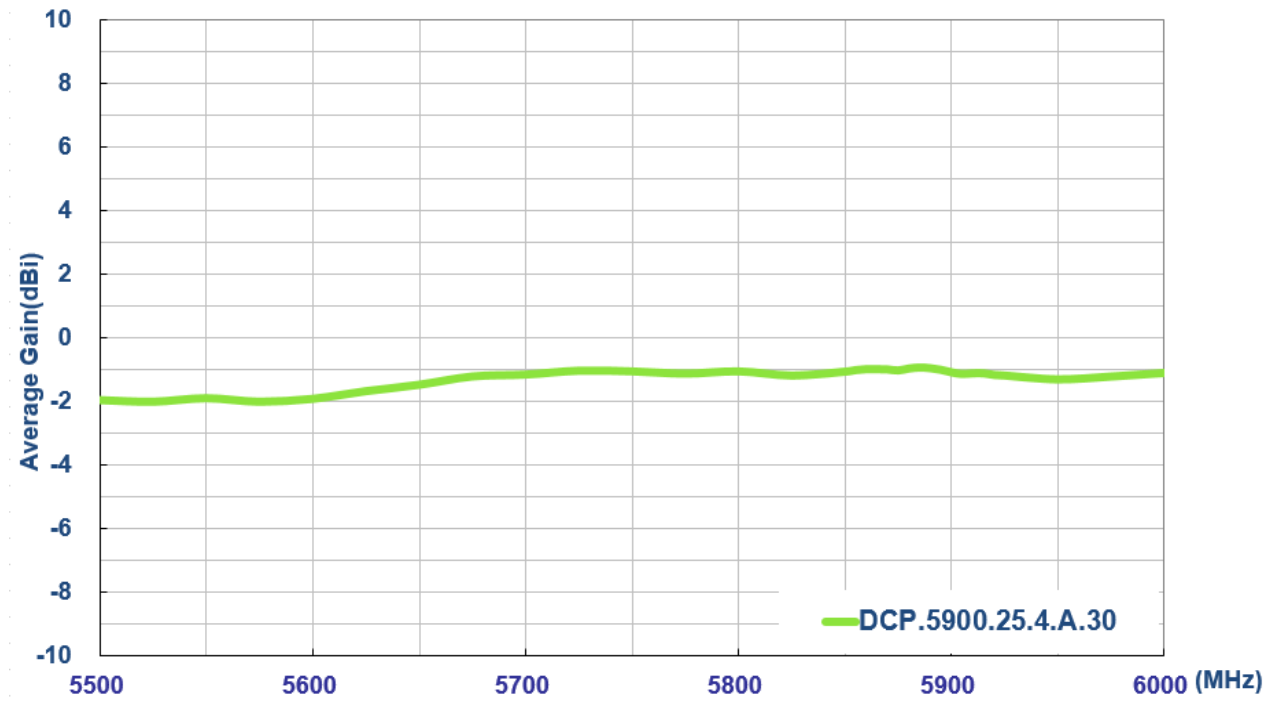

### 3.5 Peak Gain

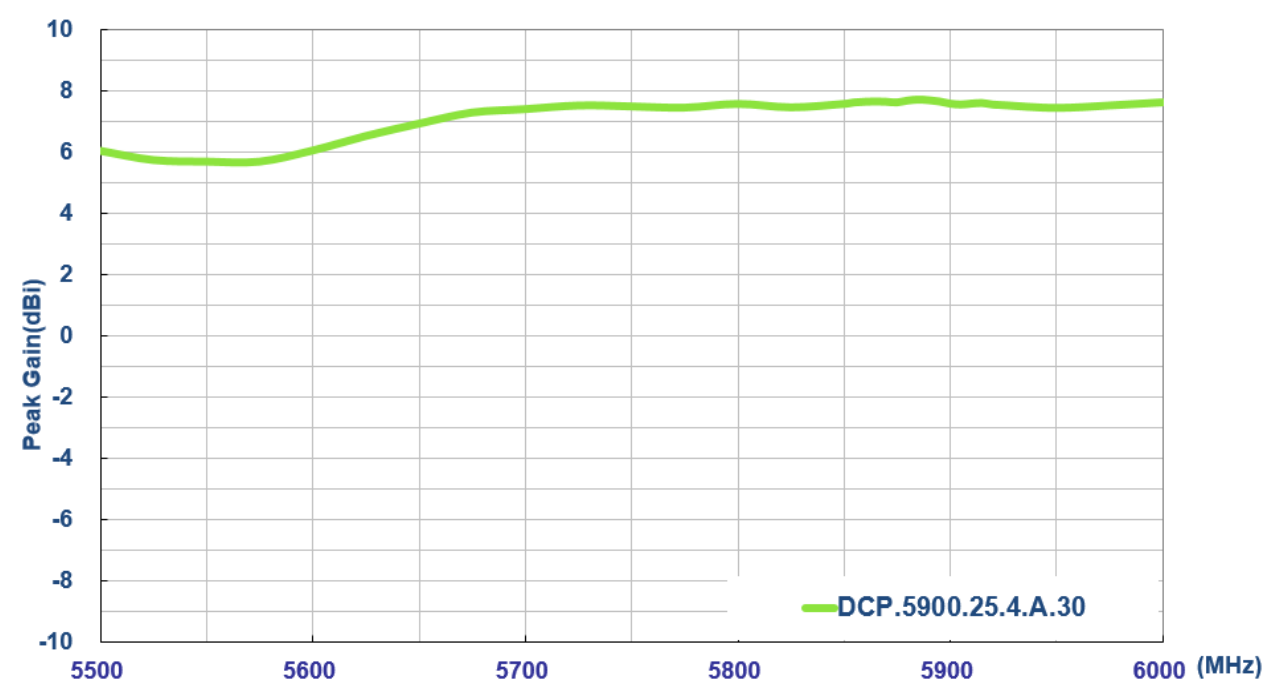

### 3.6 Axial Ratio

#### 3.6.1 XZ Plane

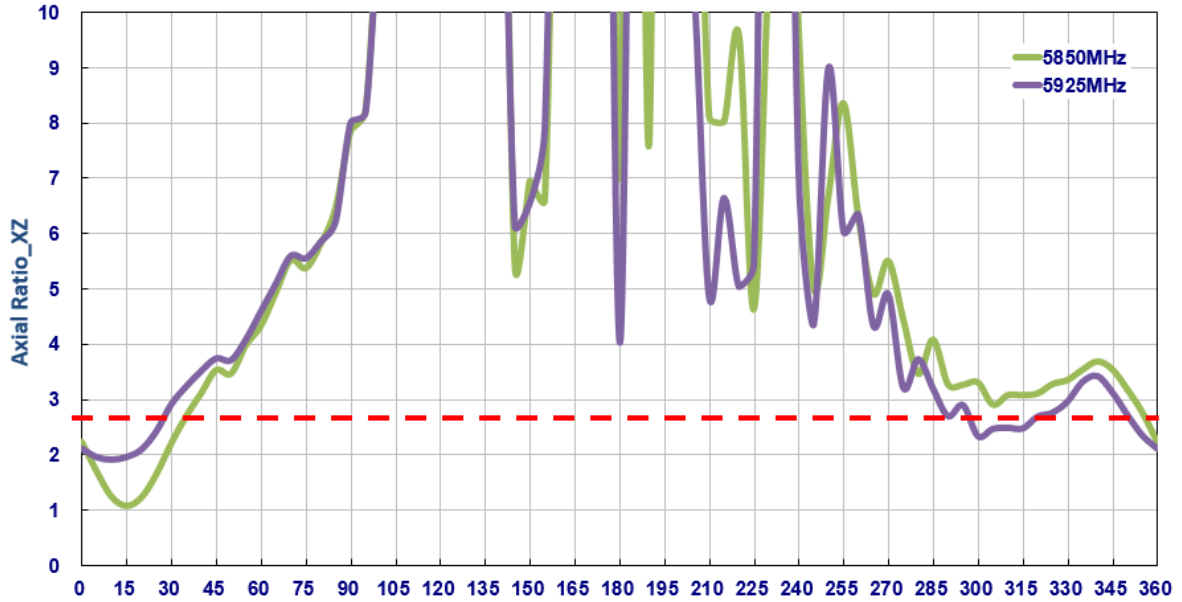

#### 3.6.2 YZ Plane

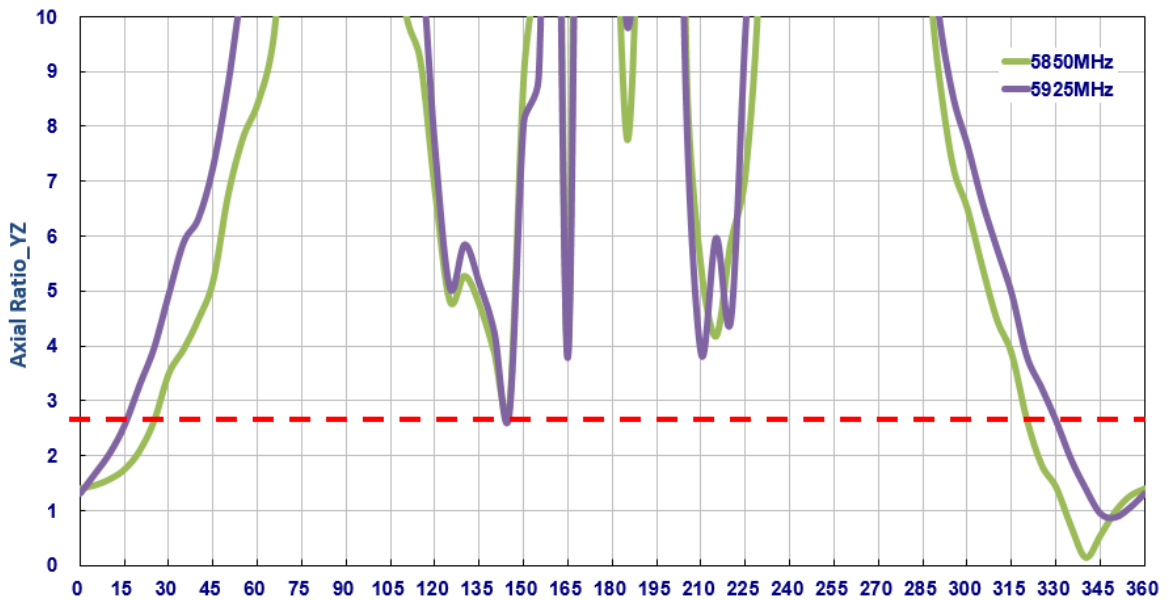

Axial Ratio	5850MHz	5925MHz
XZ	2.24dB	2.11dB
YZ	1.40dB	1.31dB

## 4. Antenna Radiation Pattern

### 4.1 Measurement Setup

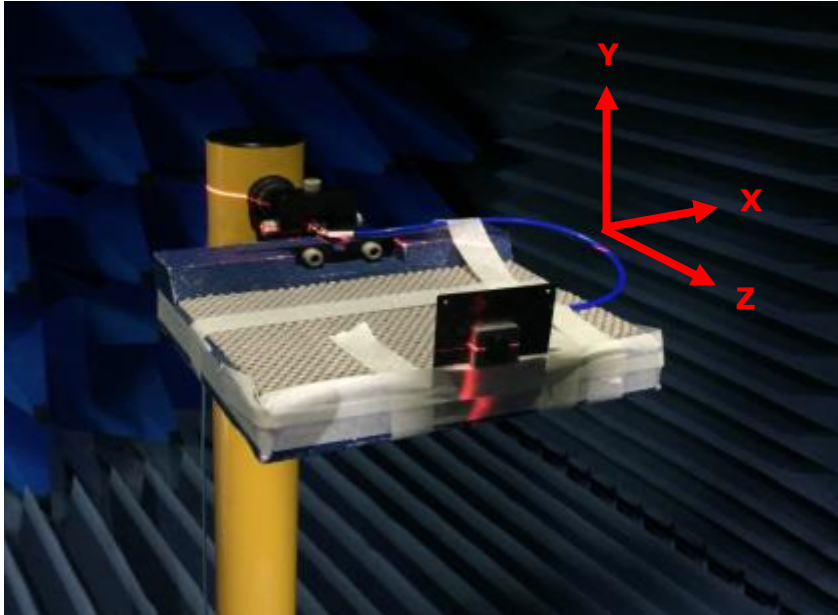



## 4.2 2D Radiation Pattern

XY Plane

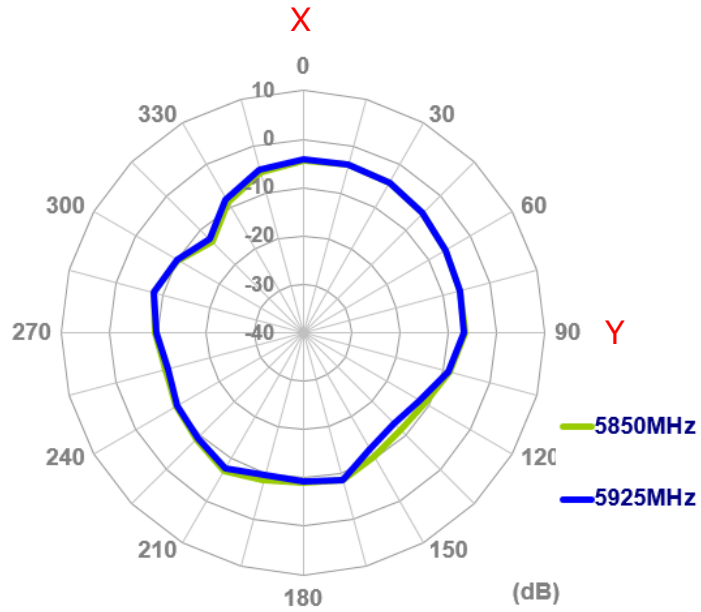

XZ Plane

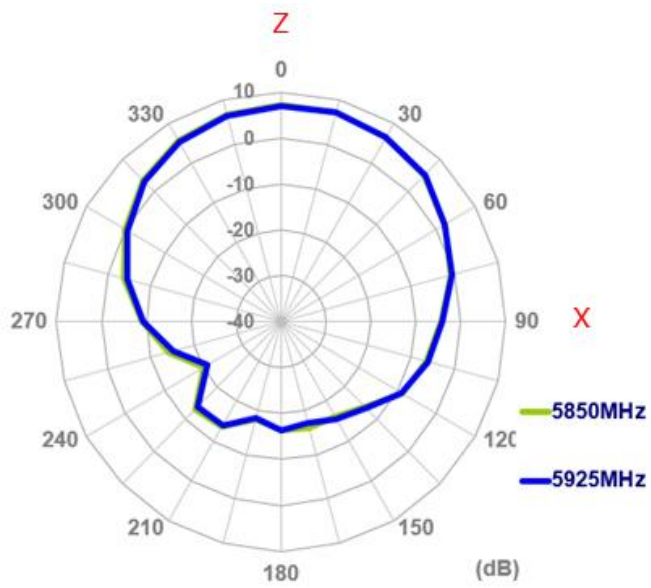

YZ Plane

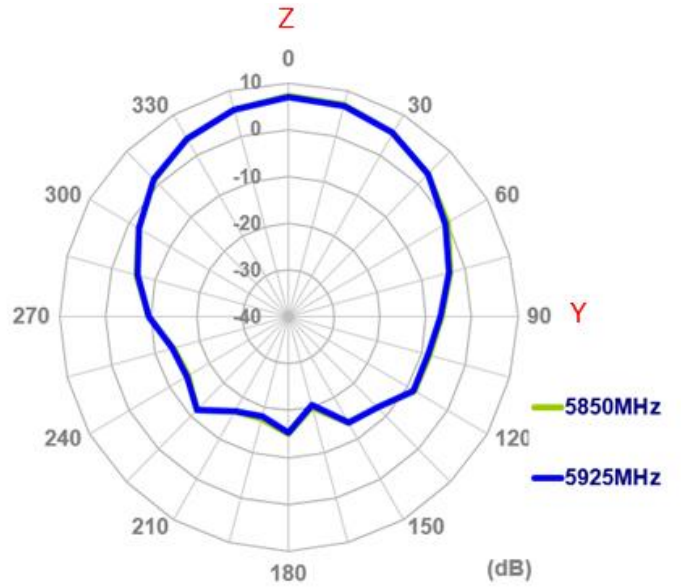

### 4.3 3D Radiation Patterns

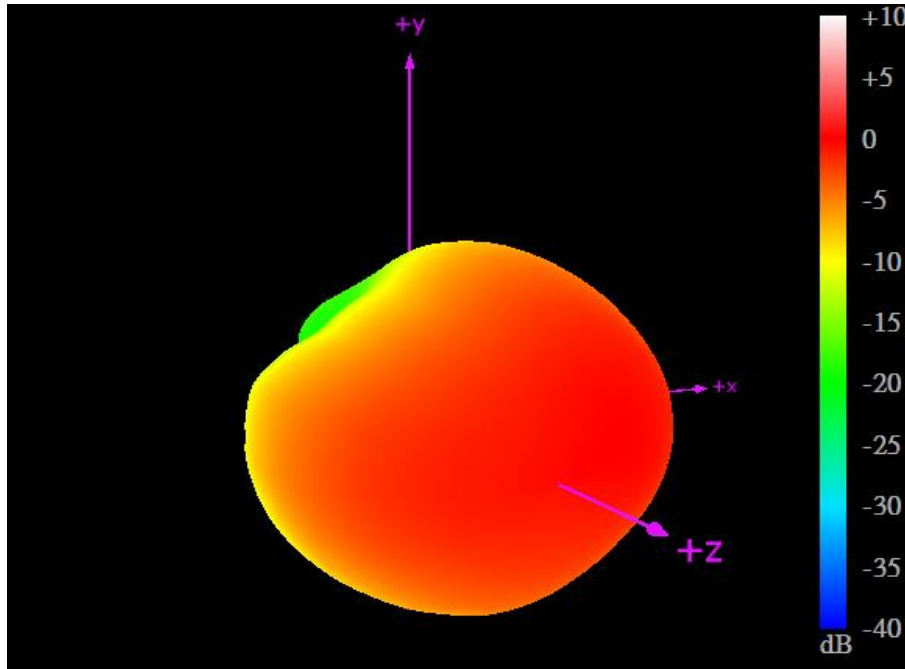

5850MHz

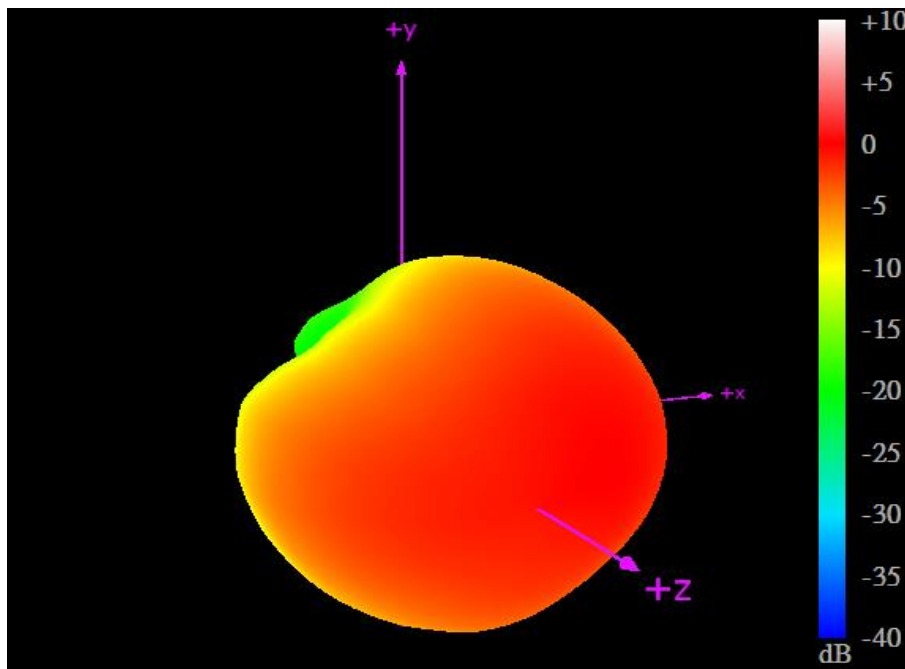

5925MHz

## 5. Mechanical Drawing (Unit: mm)

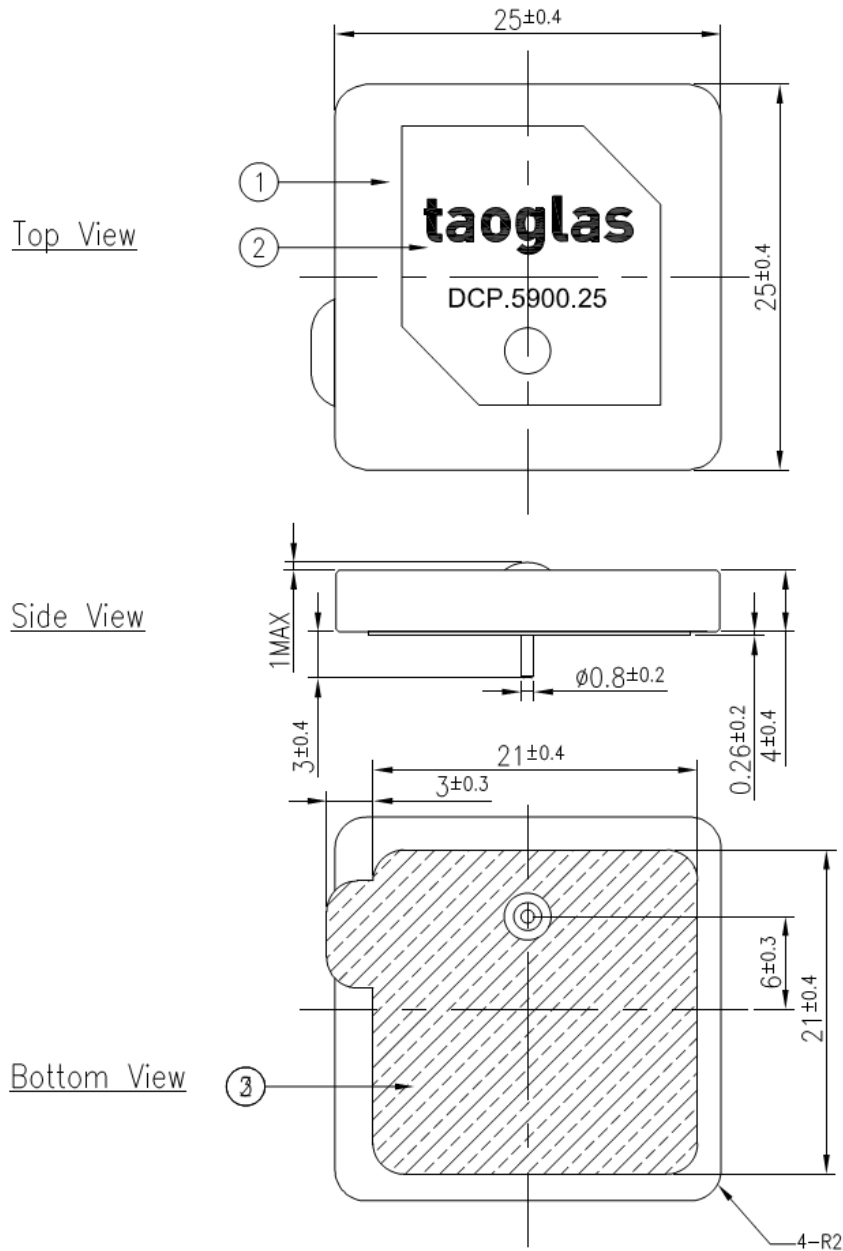

NOTE:  
 1. Double sided adhesive area. 

	Name	Material	Finish	QTY
1	DCP.5900 Patch 25x25x4	PTFE	Gray	1
2	DCP.5900 PCB	Copper	Green	1
3	Double sided Adhesive	NITTO 5000NS	White Liner	1

## 6. Test Jig and Dimensions

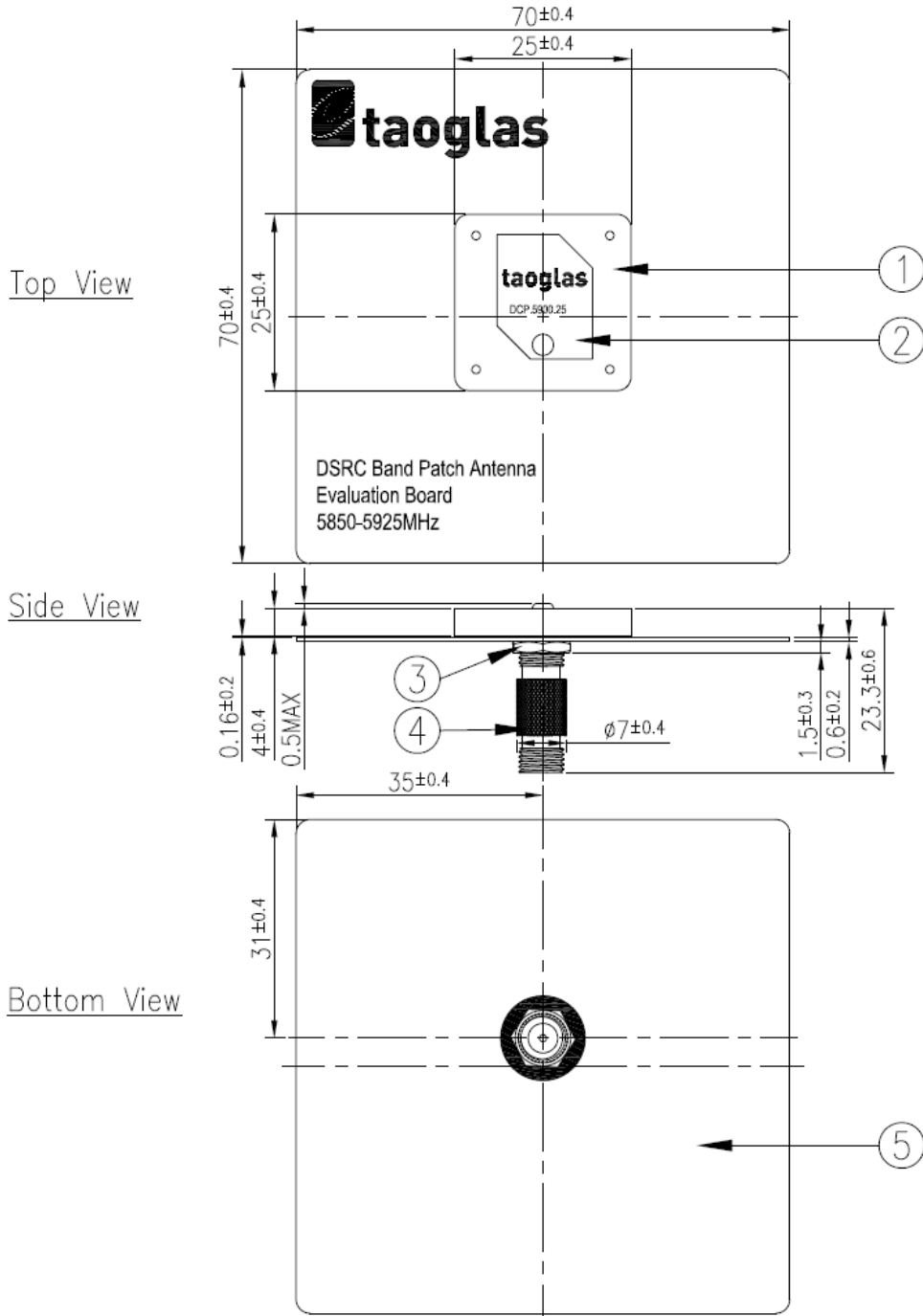

Notes:  
1.Sn Plated 

	Name	Material	Finish	QTY
1	DCP.5900 Patch 25x25x4	PTFE	Gray	1
2	PCB	Composite 0.8t	Black	1
3	SMA(F)ST	Brass	Au Plated	1

## 7. Packaging

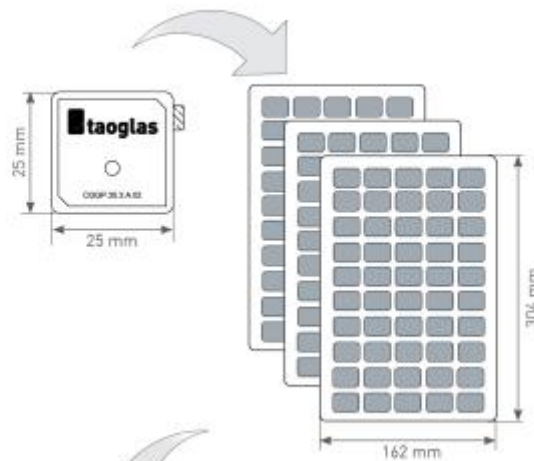

50 pcs DCP.5900.25.4.A.30 per tray  
 Tray Dimensions - 304\*162mm  
 Weight - 365g

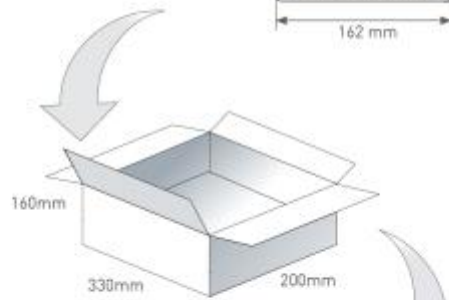

500 pcs DCP.5900.25.4.A.30 per Inner Carton  
 Inner Carton Dimensions - 330\*200\*160mm  
 Weight - 3.85kg

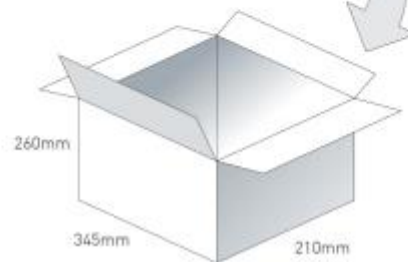

1000 pcs DCP.5900.25.4.A.30 per Carton  
 Carton Dimensions - 345\*210\*260mm  
 Weight - 8.2kg

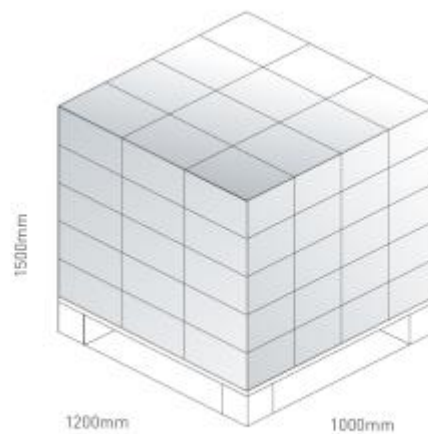

Pallet Dimensions 1200\*1000\*1500mm  
 60Cartons per Pallet  
 12 Cartons per layer  
 5 Layers

## 8. Application Note

The DCP.5900 DSRC patch antenna is designed for 70\*70mm ground plane center. The data below shows results if the antenna isn't placed at the center of ground plane.

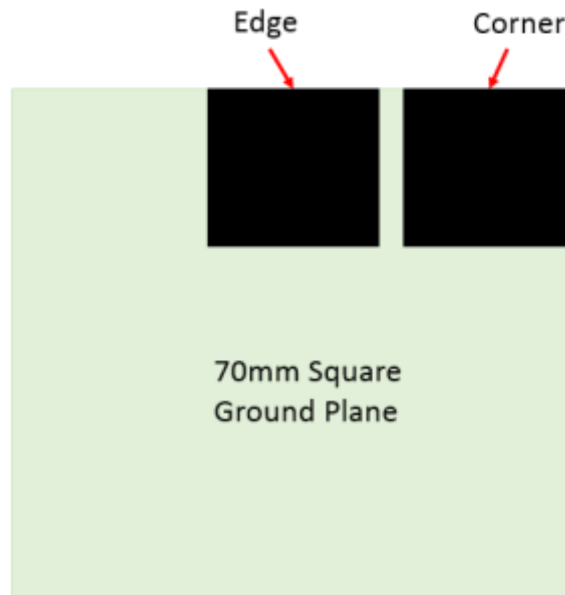

DCP.5900 on the edge



DCP.5900 in the corner

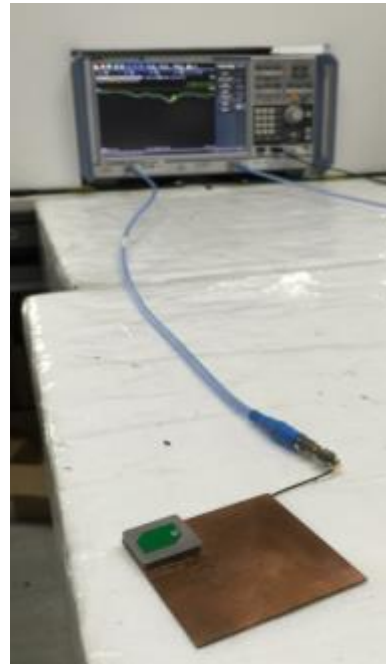

## 7.1 Return Loss

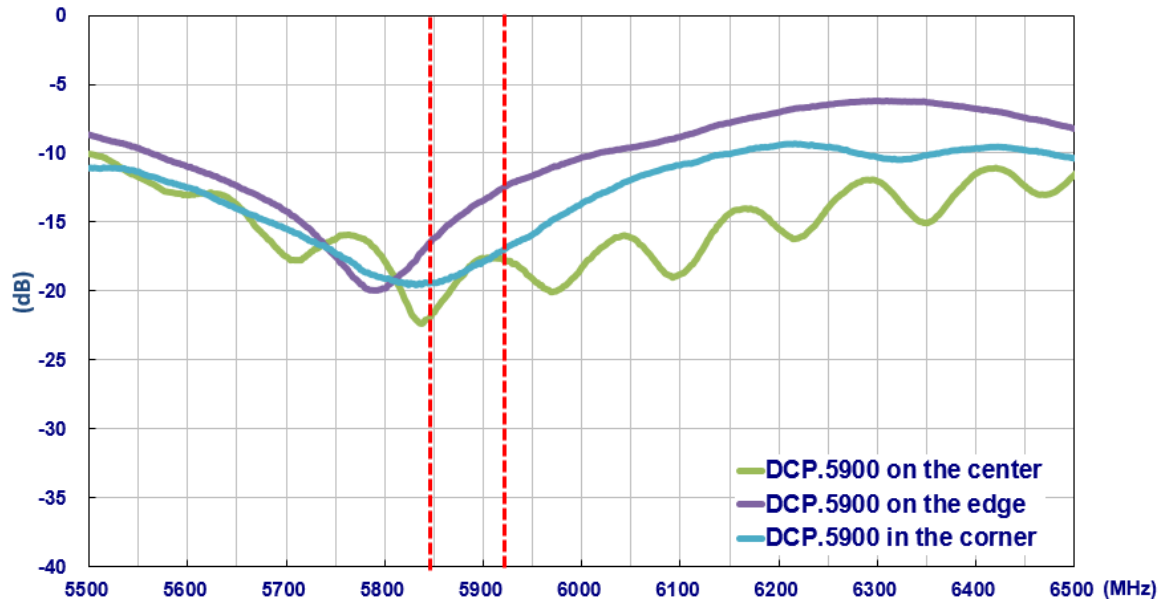

## 7.2 Efficiency

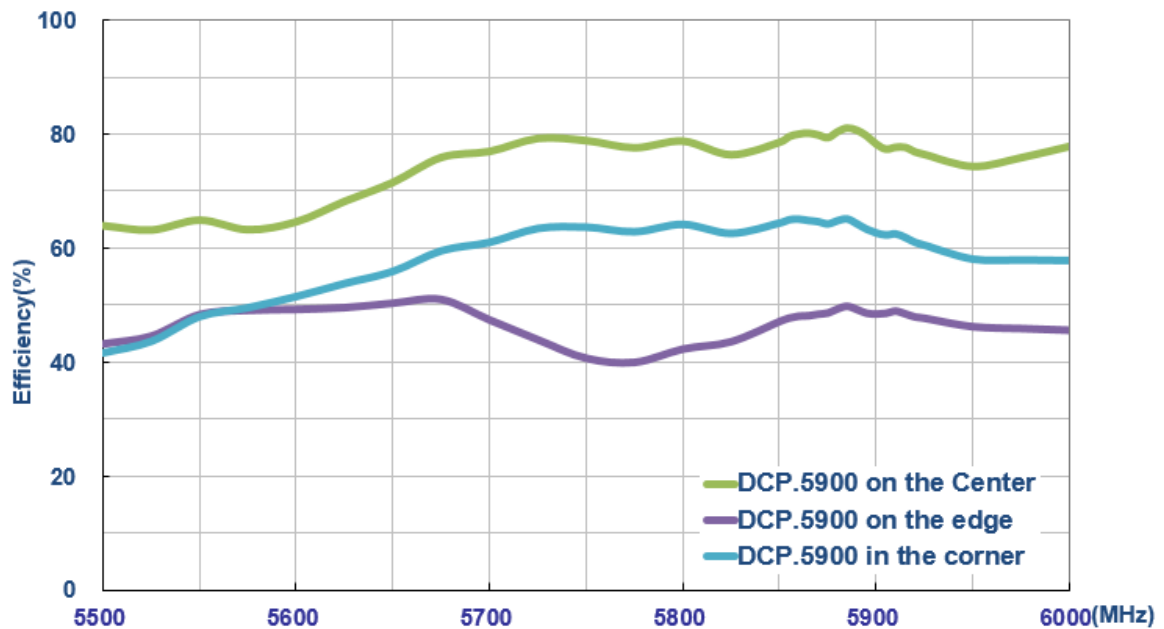

### 7.3 Average Gain

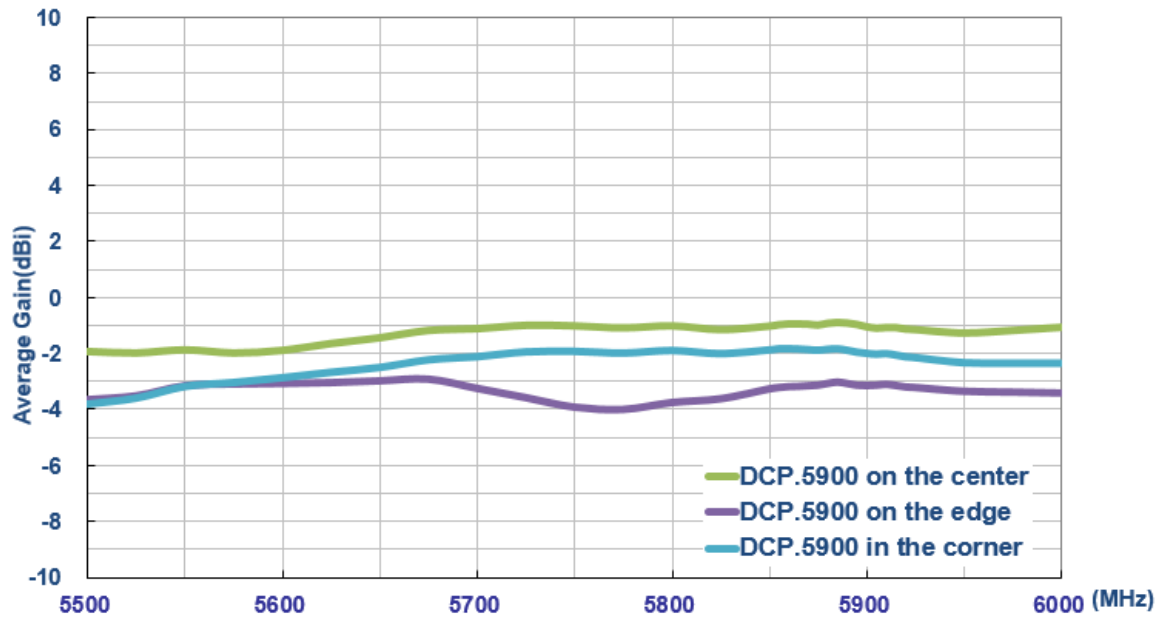

### 7.4 Peak Gain

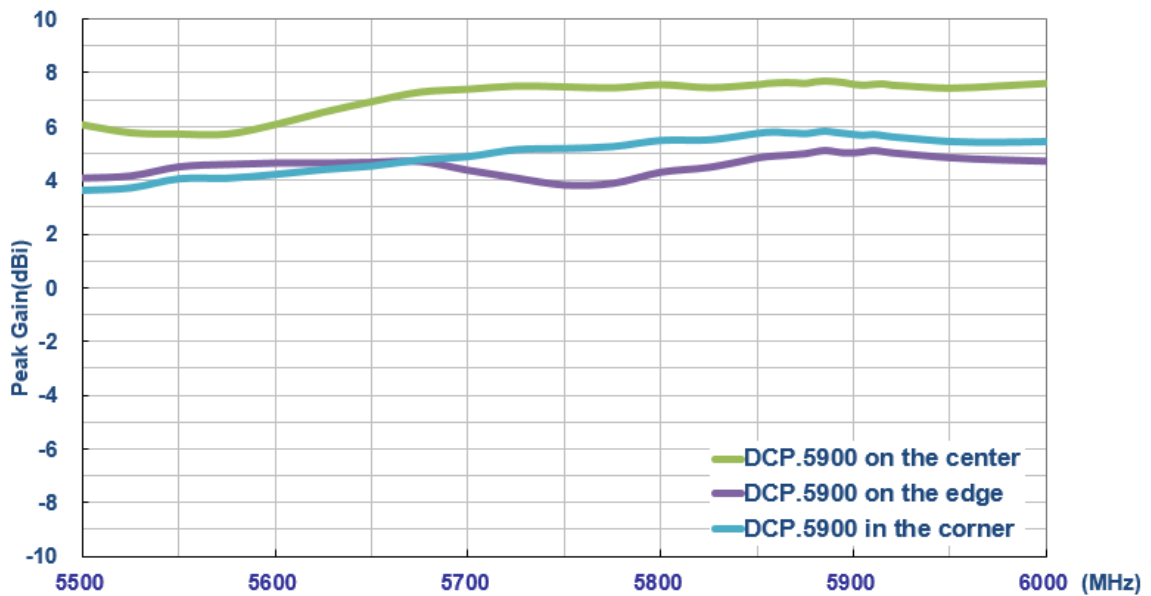



## 7.5 Axial Ratio

### 7.5.1 DCP.5900 on the edge - XZ Plane

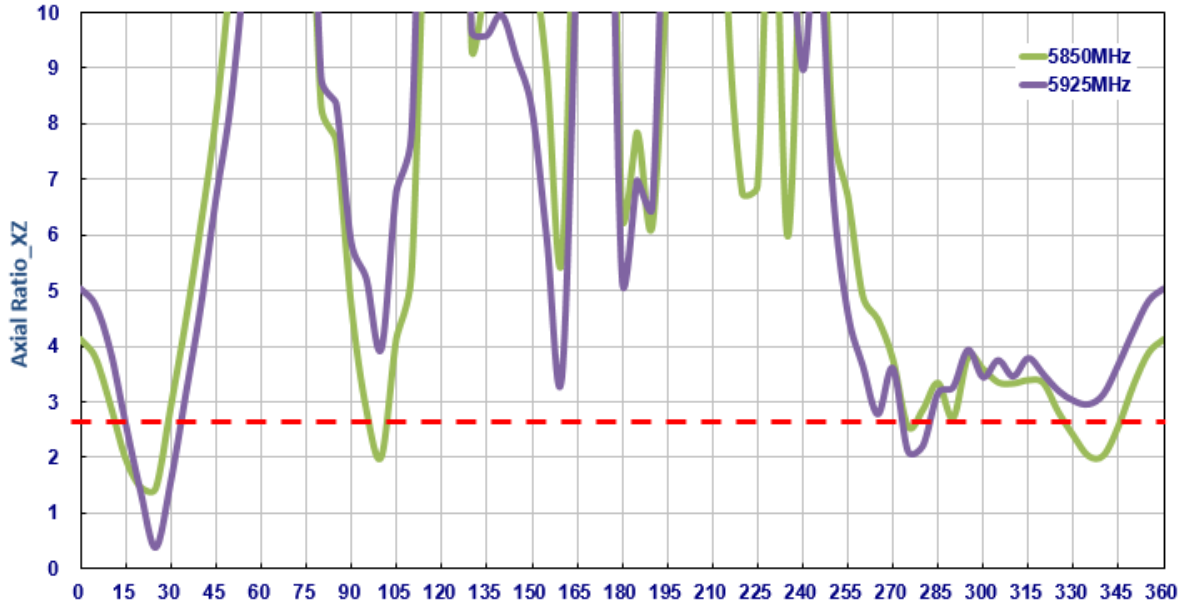

### 7.5.2 DCP.5900 on the edge - YZ Plane

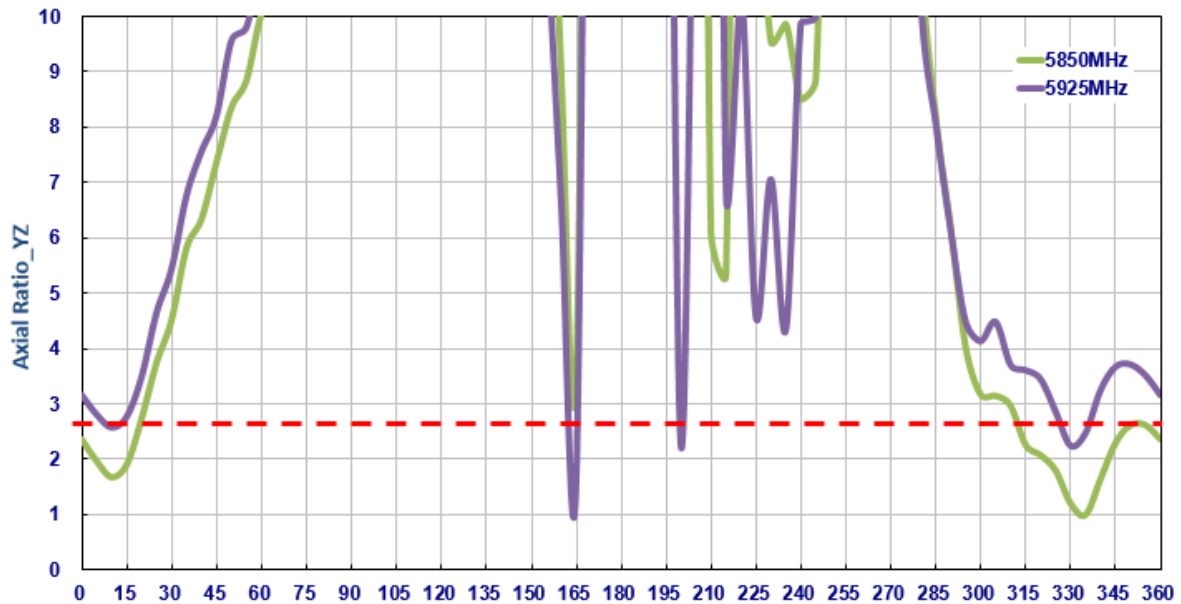

### 7.5.3 DCP.5900 in the corner - XZ Plane

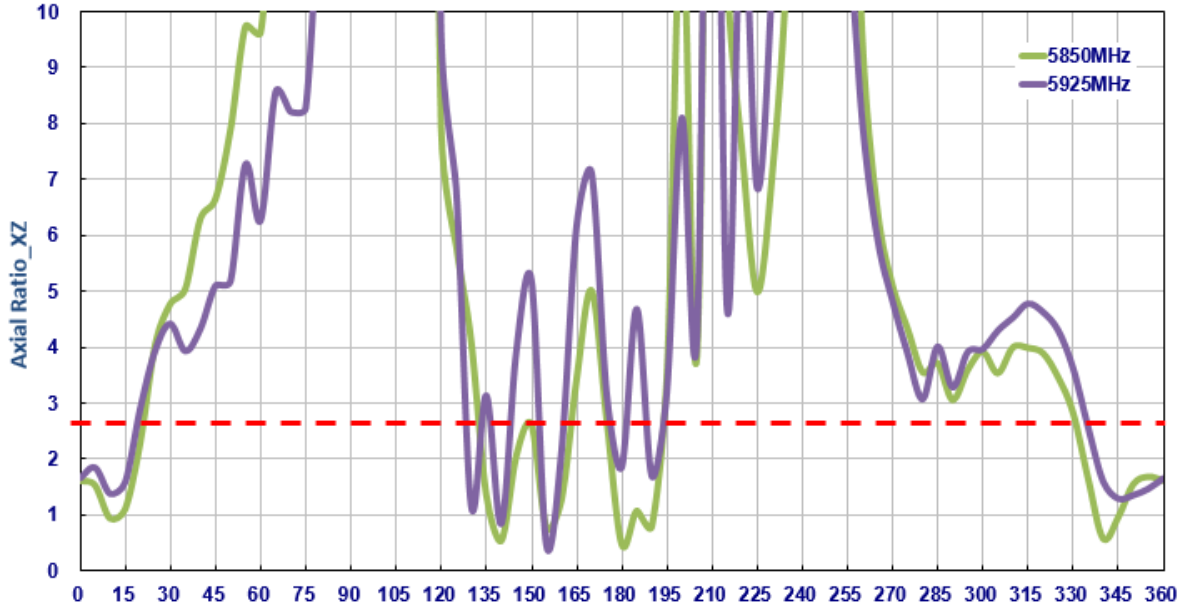

### 7.5.4 DCP.5900 in the corner - YZ Plane

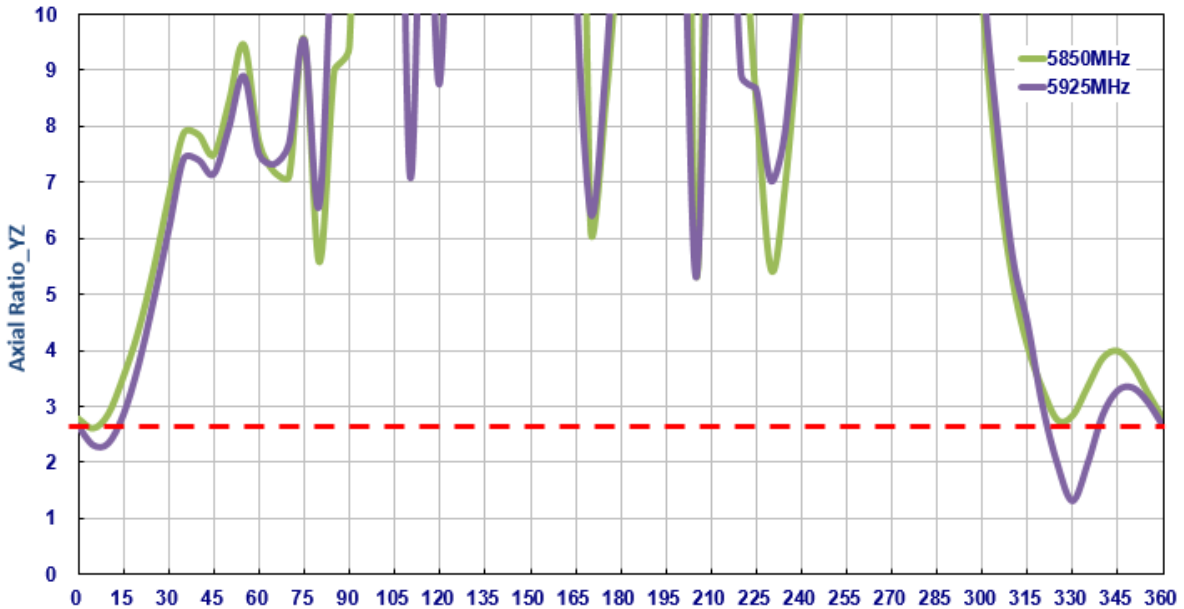

Axial Ratio	On the edge		In the corner	
	5850MHz	5925MHz	5850MHz	5925MHz
XZ	4.12dB	5.03dB	1.61dB	1.66dB
YZ	2.35dB	3.15dB	2.77dB	2.65dB



Taoglas makes no warranties based on the accuracy or completeness of the contents of this document and reserves the right to make changes to specifications and product descriptions at any time without notice. Taoglas reserves all rights to this document and the information contained herein.

Reproduction, use or disclosure to third parties without express permission is strictly prohibited.

Copyright © Taoglas Ltd.