

1-Mbit (64K x 16) Static RAM

Features

- High speed: 45 ns
- Temperature ranges
 - Industrial: -40 °C to +85 °C
 - Automotive: -40 °C to +125 °C
- Wide voltage range: 2.2 V to 3.6 V
- Pin compatible with CY62126DV30
- Ultra low standby power
 - Typical standby current: 1 μA
 - Maximum standby current: 4 μA
- Ultra low active power
 - Typical active current: 1.3 mA at f = 1 MHz
- Easy memory expansion with \overline{CE} and \overline{OE} features
- Automatic power down when deselected
- Complementary metal oxide semiconductor (CMOS) for optimum speed and power
- Offered in Pb-free 48-ball very fine pitch ball grid array (VFBGA) and 44-pin thin small outline package (TSOP) II packages

Functional Description

The CY62126EV30 is a high performance CMOS static RAM organized as 64K words by 16 bits. This device features

advanced circuit design to provide ultra low active current. This is ideal for providing More Battery Life™ (MoBL[®]) in portable applications such as cellular telephones. The device also has an automatic power down feature that significantly reduces power consumption when addresses are not toggling. Placing the device in standby mode reduces power consumption by more than 99 percent when deselected (\overline{CE} HIGH). The input and output pins (I/O₀ through I/O₁₅) are placed in a high impedance state when the device is deselected (\overline{CE} HIGH), the outputs are disabled (\overline{OE} HIGH), both Byte High Enable and Byte Low Enable are disabled (\overline{BHE} , \overline{BLE} HIGH) or during a write operation (\overline{CE} LOW and \overline{WE} LOW).

To write to the device, take Chip Enable (\overline{CE}) and Write Enable (\overline{WE}) inputs LOW. If Byte Low Enable (\overline{BLE}) is LOW, then data from I/O pins (I/O₀ through I/O₇) is written into the location specified on the address pins (A₀ through A₁₅). If Byte High Enable (\overline{BHE}) is LOW, then data from I/O pins (I/O₈ through I/O₁₅) is written into the location specified on the address pins (A₀ through A₁₅).

To read from the device, take Chip Enable (\overline{CE}) and Output Enable (\overline{OE}) LOW while forcing the Write Enable (\overline{WE}) HIGH. If Byte Low Enable (\overline{BLE}) is LOW, then data from the memory location specified by the address pins appear on I/O₀ to I/O₇. If Byte High Enable (\overline{BHE}) is LOW, then data from memory appears on I/O₈ to I/O₁₅. See the "Truth Table" on page 11 for a complete description of read and write modes.

For best practice recommendations, refer to the Cypress application note [AN1064, SRAM System Guidelines](#).

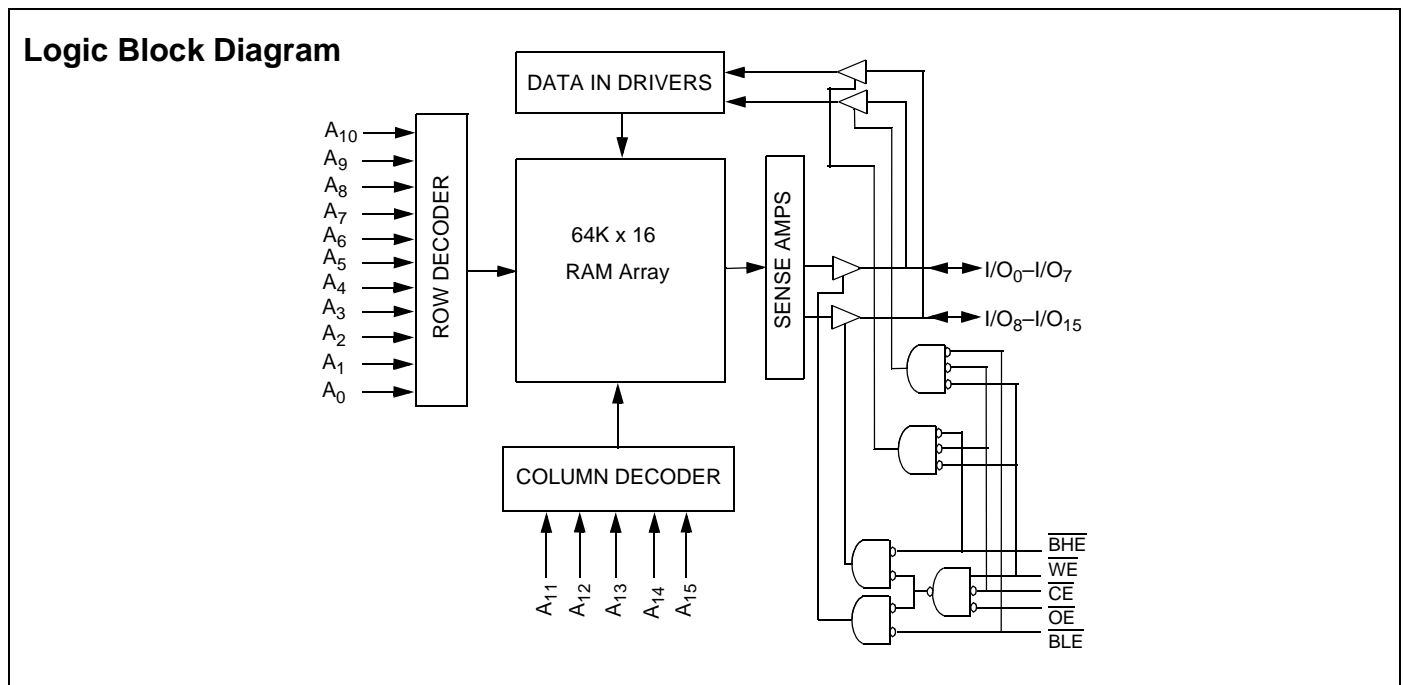

Contents

Pin Configuration	3	Ordering Information.....	12
Maximum Ratings.....	4	Ordering Code Definitions	12
Operating Range.....	4	Package Diagrams.....	13
Electrical Characteristics.....	4	Acronyms	14
Capacitance	5	Document History Page	15
Thermal Resistance.....	5	Sales, Solutions, and Legal Information	16
Data Retention Characteristics	6	Worldwide Sales and Design Support.....	16
Switching Characteristics.....	7	Products	16
Switching Waveforms	8	PSoC Solutions	16
Truth Table	11		

Pin Configuration

Figure 1. 48-Ball VFBGA (Top View)

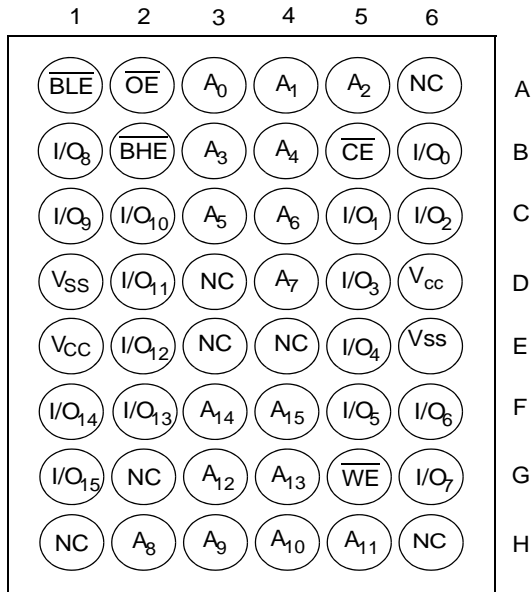

Figure 2. 44-Pin TSOP II (Top View) [1]

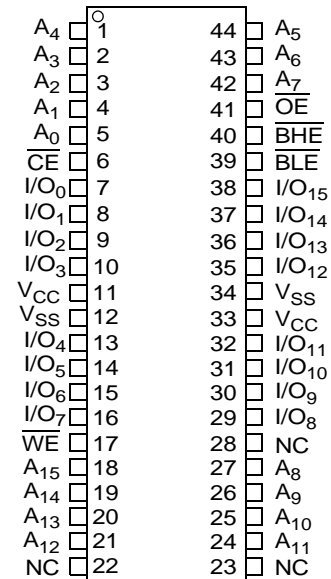

Table 1. Product Portfolio

Product	Range	V _{CC} Range (V)			Speed (ns)	Power Dissipation					
						Operating, I _{CC} (mA)				Standby, I _{SB2} (μA)	
		f = 1 MHz		f = f _{max}							
		Min	Typ ^[2]	Max		Typ ^[2]	Max	Typ ^[2]	Max	Typ ^[2]	Max
CY62126EV30LL	Industrial	2.2	3.0	3.6	45	1.3	2	11	16	1	4
CY62126EV30LL	Automotive	2.2	3.0	3.6	55	1.3	4	11	35	1	30

Notes

1. NC pins are not connected on the die.
2. Typical values are included for reference only and are not guaranteed or tested. Typical values are measured at V_{CC} = V_{CC(typ)}, T_A = 25 °C.

Maximum Ratings

Exceeding maximum ratings may shorten the battery life of the device. These user guidelines are not tested.

Storage temperature -65 °C to +150 °C
 Ambient temperature with power applied -55 °C to +125 °C
 Supply voltage to ground potential -0.3 V to 3.6 V ($V_{CCmax} + 0.3$ V)
 DC voltage applied to outputs in High Z state^[3, 4] -0.3 V to 3.6 V ($V_{CCmax} + 0.3$ V)

DC input voltage^[3, 4] -0.3 V to 3.6 V ($V_{CCmax} + 0.3$ V)
 Output current into outputs (LOW) 20 mA
 Static discharge voltage > 2001 V (MIL-STD-883, Method 3015)
 Latch up current > 200 mA

Operating Range

Device	Range	Ambient Temperature	V_{CC} ^[5]
CY62126EV30LL	Industrial	-40 °C to +85 °C	2.2 V to 3.6 V
	Automotive	-40 °C to +125 °C	

Electrical Characteristics

(Over the Operating Range)

Parameter	Description	Test Conditions	45 ns (Industrial)			55 ns (Automotive)			Unit
			Min	Typ ^[6]	Max	Min	Typ ^[6]	Max	
V_{OH}	Output high voltage	$I_{OH} = -0.1$ mA	2.0	-	-	2.0	-	-	V
		$I_{OH} = -1.0$ mA, $V_{CC} \geq 2.70$ V	2.4	-	-	2.4	-	-	V
V_{OL}	Output low voltage	$I_{OL} = 0.1$ mA	-	-	0.4	-	-	0.4	V
		$I_{OL} = 2.1$ mA, $V_{CC} \geq 2.70$ V	-	-	0.4	-	-	0.4	V
V_{IH}	Input high voltage	$V_{CC} = 2.2$ V to 2.7 V	1.8	-	$V_{CC} + 0.3$	1.8	-	$V_{CC} + 0.3$	V
		$V_{CC} = 2.7$ V to 3.6 V	2.2	-	$V_{CC} + 0.3$	2.2	-	$V_{CC} + 0.3$	V
V_{IL}	Input low voltage	$V_{CC} = 2.2$ V to 2.7 V	-0.3	-	0.6	-0.3	-	0.6	V
		$V_{CC} = 2.7$ V to 3.6 V	-0.3	-	0.8	-0.3	-	0.8	V
I_{IX}	Input leakage current	$GND \leq V_I \leq V_{CC}$	-1	-	+1	-4	-	+4	μ A
I_{OZ}	Output leakage current	$GND \leq V_O \leq V_{CC}$, Output Disabled	-1	-	+1	-4	-	+4	μ A
I_{CC}	V_{CC} operating supply current	$f = f_{max} = 1/t_{RC}$		11	16	-	11	35	mA
		$f = 1$ MHz		1.3	2.0	-	1.3	4.0	
I_{SB1}	Automatic CE power down current—CMOS inputs	$\overline{CE} \geq V_{CC} - 0.2$ V, $V_{IN} \geq V_{CC} - 0.2$ V, $V_{IN} \leq 0.2$ V) $f = f_{max}$ (Address and Data Only), $f = 0$ (OE, BHE, BLE and WE), $V_{CC} = 3.60$ V	-	1	4	-	1	35	μ A
I_{SB2} ^[7]	Automatic CE power down current—CMOS inputs	$\overline{CE} \geq V_{CC} - 0.2$ V, $V_{IN} \geq V_{CC} - 0.2$ V or $V_{IN} \leq 0.2$ V, $f = 0$, $V_{CC} = 3.60$ V	-	1	4	-	1	30	μ A

Notes

- $V_{IL(min)}$ = -2.0 V for pulse durations less than 20 ns.
- $V_{IH(max)}$ = $V_{CC} + 0.75$ V for pulse durations less than 20 ns.
- Full device AC operation assumes a 100 μ s ramp time from 0 to $V_{CC(min)}$ and 200 μ s wait time after V_{CC} stabilization.
- Typical values are included for reference only and are not guaranteed or tested. Typical values are measured at $V_{CC} = V_{CC(typ)}$, $T_A = 25$ °C.
- Chip enable (CE) needs to be tied to CMOS levels to meet the I_{SB2} / I_{CCDR} spec. Other inputs can be left floating.

Capacitance

For all packages. Tested initially and after any design or process changes that may affect these parameters.

Parameter	Description	Test Conditions	Max	Unit
C _{IN}	Input capacitance	T _A = 25 °C, f = 1 MHz, V _{CC} = V _{CC(typ)}	10	pF
C _{OUT}	Output capacitance		10	pF

Thermal Resistance

Tested initially and after any design or process changes that may affect these parameters.

Parameter	Description	Test Conditions	VFBGA Package	TSOP II Package	Unit
Θ _{JA}	Thermal resistance (Junction to ambient)	Still Air, soldered on a 4.25 × 1.125 inch, two-layer printed circuit board	58.85	28.2	°C/W
Θ _{JC}	Thermal resistance (Junction to case)		17.01	3.4	°C/W

Figure 3. AC Test Loads and Waveforms

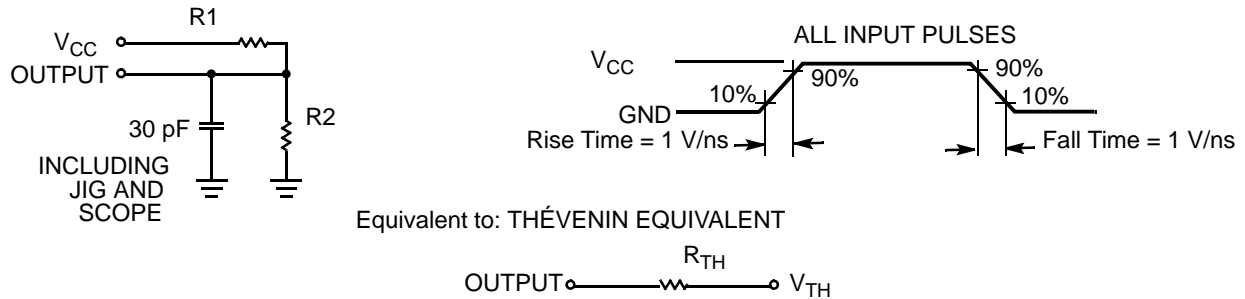

Parameters	2.2 V - 2.7 V	2.7 V - 3.6 V	Unit
R ₁	16600	1103	Ω
R ₂	15400	1554	Ω
R _{TH}	8000	645	Ω
V _{TH}	1.2	1.75	V

Data Retention Characteristics

Over the Operating Range

Parameter	Description	Conditions	Min	Typ ^[8]	Max	Unit	
V_{DR}	V_{CC} for data retention		1.5	–	–	V	
$I_{CCDR}^{[9]}$	Data retention current	$V_{CC} = V_{DR}$, $\overline{CE} \geq V_{CC} - 0.2\text{ V}$, $V_{IN} \geq V_{CC} - 0.2\text{ V}$ or $V_{IN} \leq 0.2\text{ V}$	Industrial	–	–	3	μA
			Automotive	–	–	30	μA
$t_{CDR}^{[10]}$	Chip deselect to data retention time		0	–	–	ns	
$t_R^{[10]}$	Operation recovery time		t_{RC}	–	–	ns	

Figure 4. Data Retention Waveform

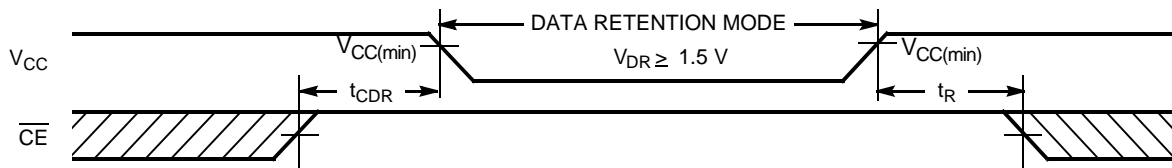

Notes

- 8. Typical values are included for reference only and are not guaranteed or tested. Typical values are measured at $V_{CC} = V_{CC(typ)}$, $T_A = 25\text{ }^\circ\text{C}$.
- 9. Tested initially and after any design or process changes that may affect these parameters.
- 10. Full device AC operation requires linear V_{CC} ramp from V_{DR} to $V_{CC(min)} > 100\text{ }\mu\text{s}$.

Switching Characteristics

Over the Operating Range ^[11, 12]

Parameter	Description	45 ns (Industrial)		55 ns (Automotive)		Unit
		Min	Max	Min	Max	
Read Cycle						
t _{RC}	Read cycle time	45	–	55	–	ns
t _{AA}	Address to data valid	–	45	–	55	ns
t _{OHA}	Data hold from address change	10	–	10	–	ns
t _{ACE}	\overline{CE} LOW to data valid	–	45	–	55	ns
t _{DOE}	\overline{OE} LOW to data valid	–	22	–	25	ns
t _{LZOE}	\overline{OE} LOW to Low Z ^[13]	5	–	5	–	ns
t _{HZOE}	\overline{OE} HIGH to High Z ^[13, 14]	–	18	–	20	ns
t _{LZCE}	\overline{CE} LOW to Low Z ^[13]	10	–	10	–	ns
t _{HZCE}	\overline{CE} HIGH to High Z ^[13, 14]	–	18	–	20	ns
t _{PU}	\overline{CE} LOW to power up	0	–	0	–	ns
t _{PD}	\overline{CE} HIGH to power down	–	45	–	55	ns
t _{DBE}	\overline{BHE} / \overline{BLE} LOW to data valid	–	22	–	25	ns
t _{LZBE}	\overline{BHE} / \overline{BLE} LOW to Low Z ^[13]	5	–	5	–	ns
t _{HZBE}	\overline{BHE} / \overline{BLE} HIGH to High Z ^[13, 14]	–	18	–	20	ns
Write Cycle ^[15]						
t _{WC}	Write cycle time	45	–	55	–	ns
t _{SCE}	\overline{CE} LOW to write end	35	–	40	–	ns
t _{AW}	Address setup to write end	35	–	40	–	ns
t _{HA}	Address hold from write end	0	–	0	–	ns
t _{SA}	Address setup to write start	0	–	0	–	ns
t _{PWE}	\overline{WE} pulse width	35	–	40	–	ns
t _{BW}	\overline{BHE} / \overline{BLE} pulse width	35	–	40	–	ns
t _{SD}	Data setup to write end	25	–	25	–	ns
t _{HD}	Data hold from write end	0	–	0	–	ns
t _{HZWE}	\overline{WE} LOW to High Z ^[13, 14]	–	18	–	20	ns
t _{LZWE}	\overline{WE} HIGH to Low Z ^[13]	10	–	10	–	ns

Notes

11. Test conditions assume signal transition time of 3 ns or less, timing reference levels of $V_{CC(typ)}/2$, input pulse levels of 0 to $V_{CC(typ)}$, and output loading of the specified I_{OL}/I_{OH} and 30-pF load capacitance.
12. AC timing parameters are subject to byte enable signals (\overline{BHE} or \overline{BLE}) not switching when chip is disabled. See [application note AN13842](#) for further clarification.
13. At any temperature and voltage condition, t_{HZCE} is less than t_{LZCE}, t_{HZBE} is less than t_{LZBE}, t_{HZOE} is less than t_{LZOE}, and t_{HZWE} is less than t_{LZWE} for any device.
14. t_{HZOE}, t_{HZCE}, t_{HZBE}, and t_{HZWE} transitions are measured when the outputs enter a high impedance state.
15. The internal write time of the memory is defined by the overlap of \overline{WE} , $\overline{CE} = V_{IL}$, \overline{BHE} , \overline{BLE} or both = V_{IL} . All signals must be active to initiate a write and any of these signals can terminate a write by going inactive. The data input setup and hold timing must refer to the edge of signal that terminates write.

Switching Waveforms

Figure 5. Read Cycle No. 1 (Address transition controlled)^[16, 17]

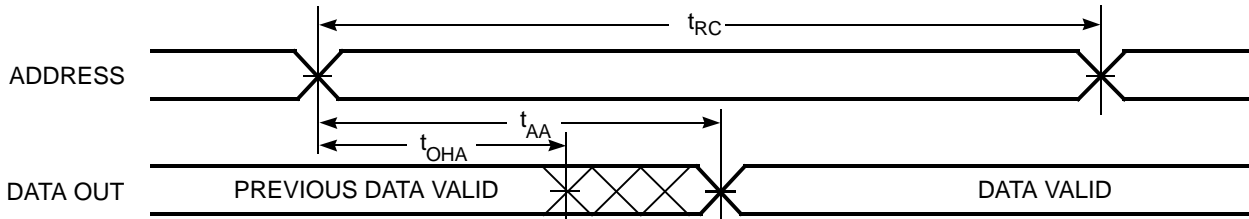
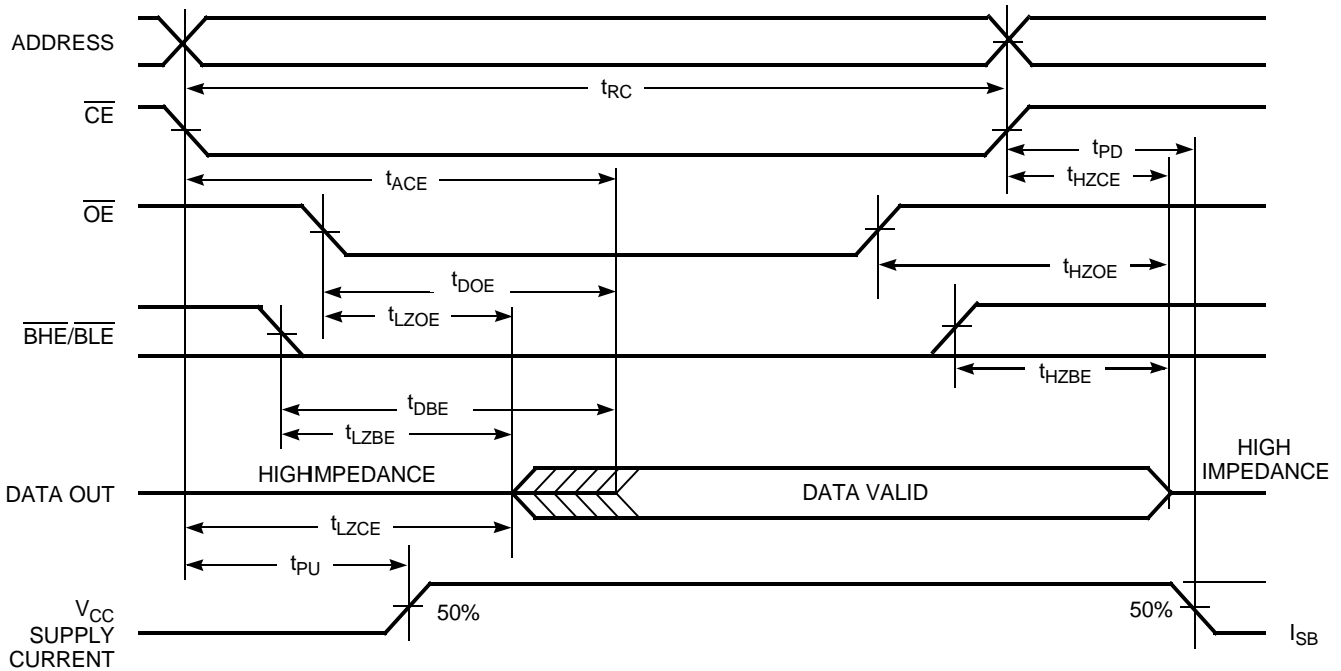

Figure 6. Read Cycle No. 2 (\overline{OE} controlled)^[17, 18]



Notes

- 16. The device is continuously selected. \overline{OE} , \overline{CE} = V_{IL} , \overline{BHE} , \overline{BLE} , or both = V_{IL} .
- 17. \overline{WE} is high for read cycle.
- 18. Address valid before or similar to \overline{CE} and \overline{BHE} , \overline{BLE} transition LOW.

Switching Waveforms (continued)

Figure 7. Write Cycle No. 1 (\overline{WE} controlled)^[19, 20, 21]

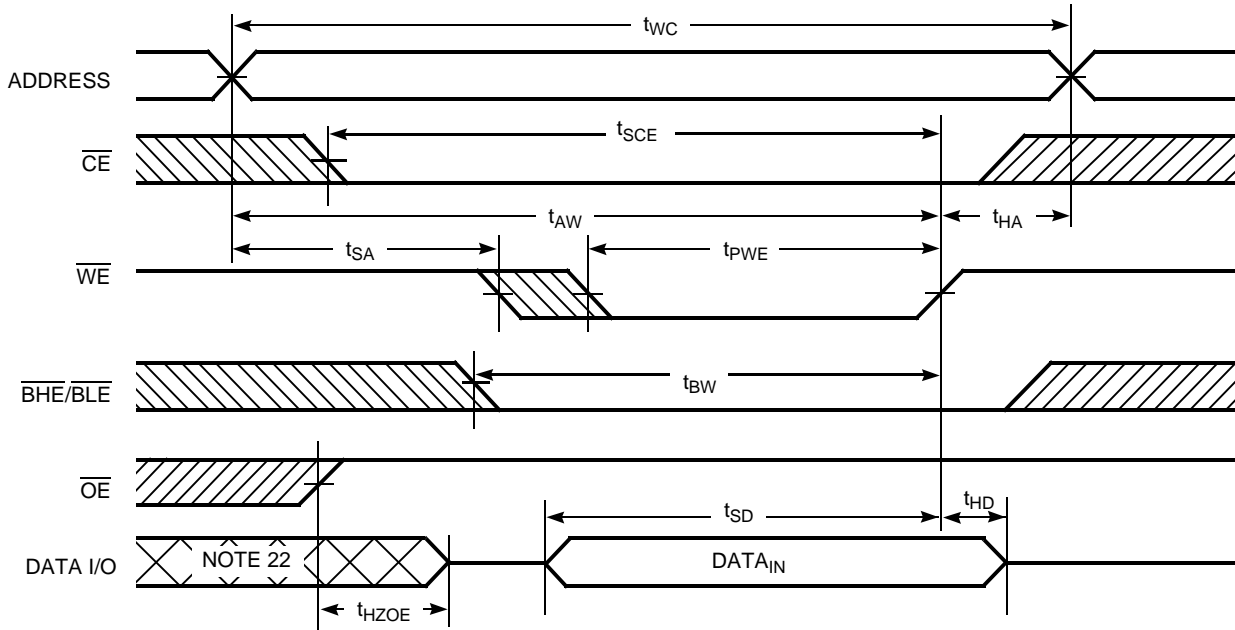
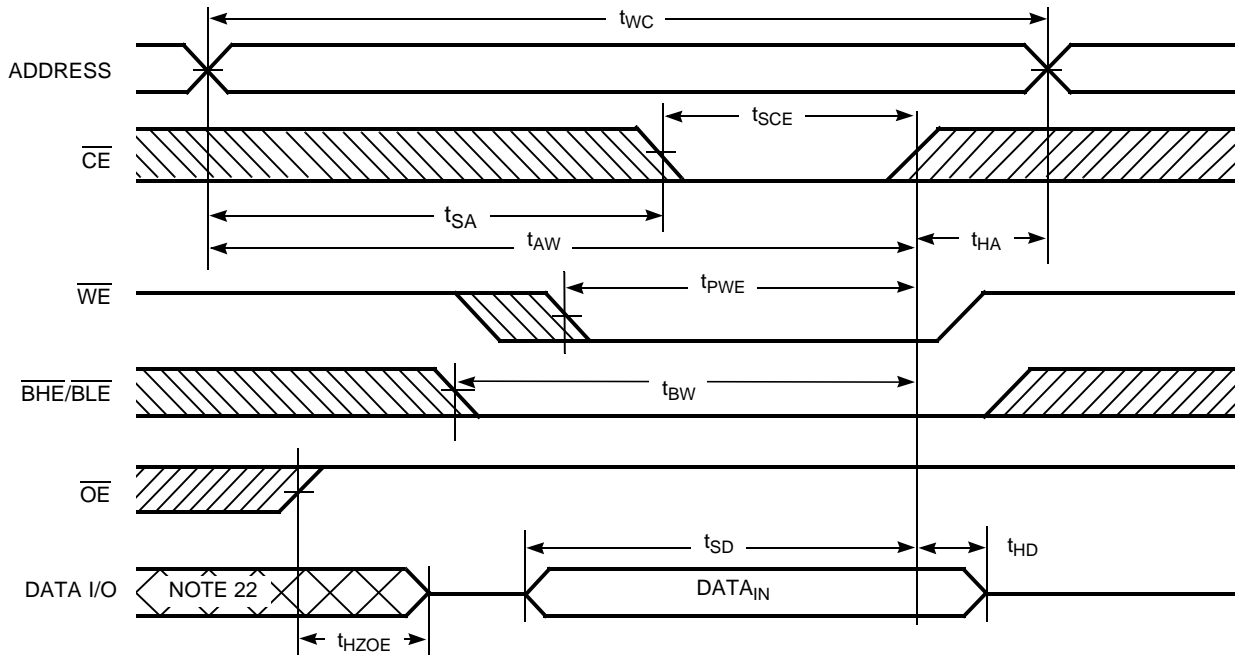

Figure 8. Write Cycle No. 2 (\overline{CE} controlled)^[19, 20, 21]



Notes

- 19. The internal write time of the memory is defined by the overlap of \overline{WE} , $\overline{CE} = V_{IL}$, \overline{BHE} , \overline{BLE} or both = V_{IL} . All signals must be active to initiate a write and any of these signals can terminate a write by going inactive. The data input setup and hold timing must refer to the edge of signal that terminates write.
- 20. Data I/O is high impedance if $\overline{OE} = V_{IH}$.
- 21. If \overline{CE} goes high simultaneously with $\overline{WE} = V_{IH}$, the output remains in a high impedance state.
- 22. During this period, the I/Os are in output state. Do not apply input signals.

Switching Waveforms (continued)

Figure 9. Write Cycle No. 3 (\overline{WE} controlled, \overline{OE} LOW)^[23]

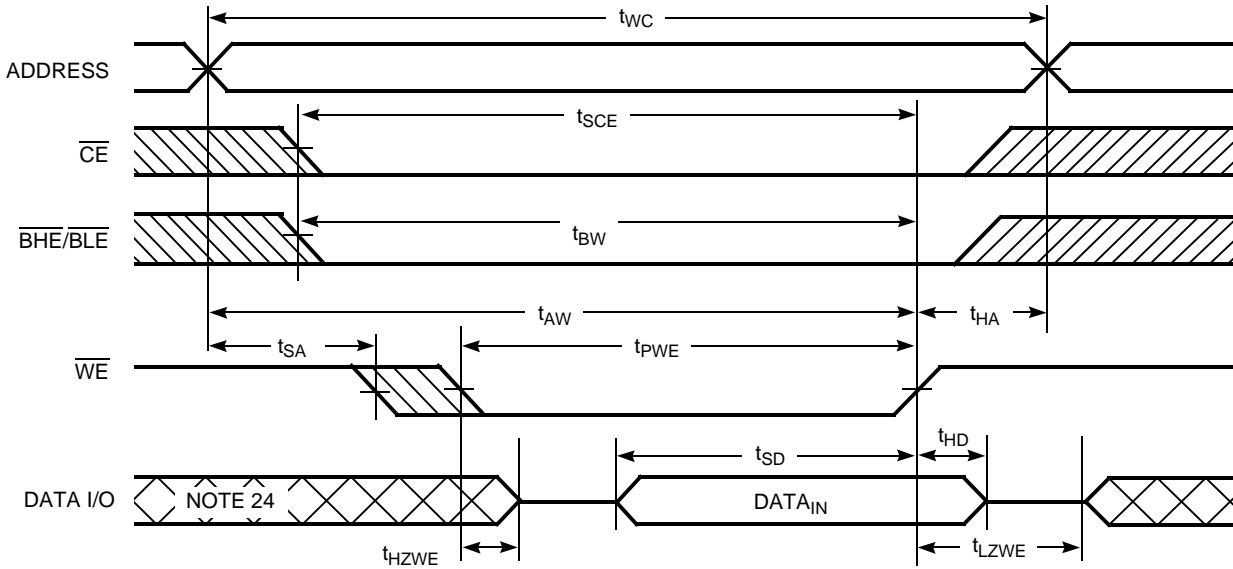
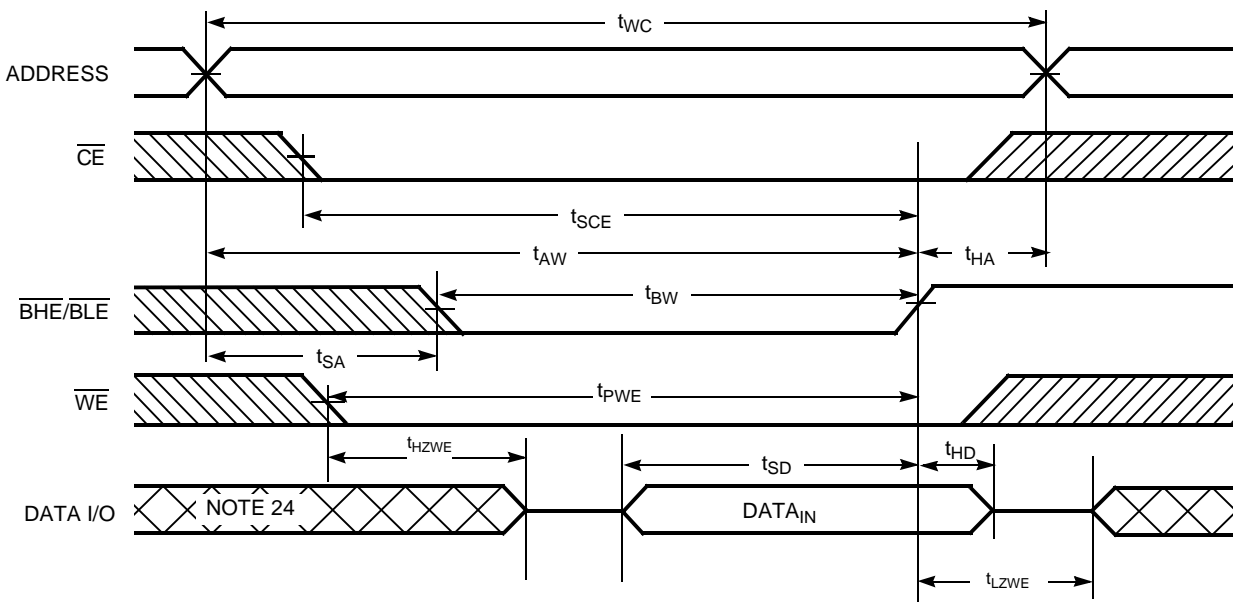

Figure 10. Write Cycle No. 4 ($\overline{BHE/BLE}$ controlled, \overline{OE} LOW)^[23]



Note

- 23. If \overline{CE} goes high simultaneously with $\overline{WE} = V_{IH}$, the output remains in a high impedance state.
- 24. During this period, the I/Os are in output state. Do not apply input signals.

Truth Table

$\overline{CE}^{[25]}$	\overline{WE}	\overline{OE}	\overline{BHE}	\overline{BLE}	Inputs/Outputs	Mode	Power
H	X	X	X	X	High Z	Deselect/power down	Standby (I_{SB})
L	X	X	H	H	High Z	Output disabled	Active (I_{CC})
L	H	L	L	L	Data out (I/O_0 – I/O_{15})	Read	Active (I_{CC})
L	H	L	H	L	Data out (I/O_0 – I/O_7); I/O_8 – I/O_{15} in High Z	Read	Active (I_{CC})
L	H	L	L	H	Data out (I/O_8 – I/O_{15}); I/O_0 – I/O_7 in High Z	Read	Active (I_{CC})
L	H	H	L	L	High Z	Output disabled	Active (I_{CC})
L	H	H	H	L	High Z	Output disabled	Active (I_{CC})
L	H	H	L	H	High Z	Output disabled	Active (I_{CC})
L	L	X	L	L	Data in (I/O_0 – I/O_{15})	Write	Active (I_{CC})
L	L	X	H	L	Data in (I/O_0 – I/O_7); I/O_8 – I/O_{15} in High Z	Write	Active (I_{CC})
L	L	X	L	H	Data in (I/O_8 – I/O_{15}); I/O_0 – I/O_7 in High Z	Write	Active (I_{CC})

Note

25. Chip enable must be at CMOS levels (not floating). Intermediate voltage levels on this pin is not permitted.

Ordering Information

Speed (ns)	Ordering Code	Package Diagram	Package Type	Operating Range
45	CY62126EV30LL-45BVXI	51-85150	48-ball VFBGA (Pb-free)	Industrial
	CY62126EV30LL-45ZSXI	51-85087	44-pin TSOP II (Pb-free)	Industrial
	CY62126EV30LL-45ZSXA	51-85087	44-pin TSOP II (Pb-free)	Automotive-A
55	CY62126EV30LL-55BVXE	51-85150	48-ball VFBGA (Pb-free)	Automotive-E
	CY62126EV30LL-55ZSXE	51-85087	44-pin TSOP II (Pb-free)	Automotive-E

Contact your local Cypress sales representative for availability of other parts.

Ordering Code Definitions

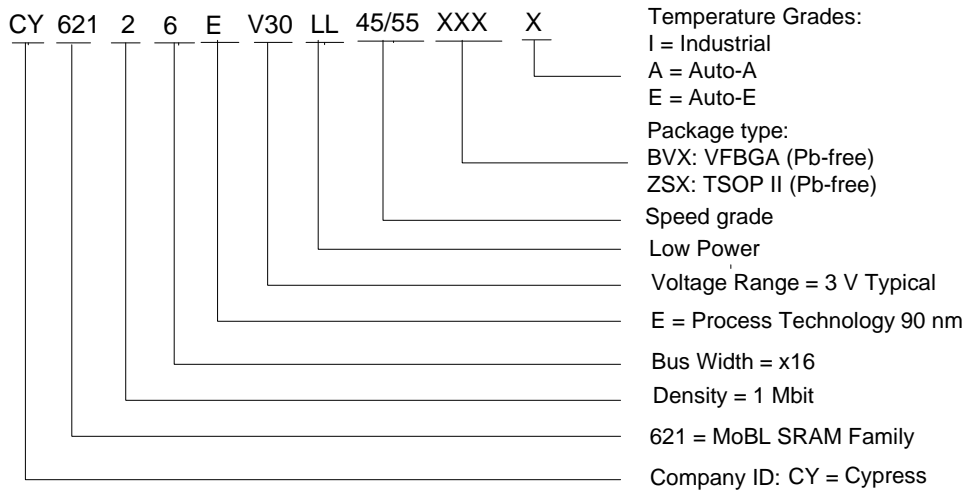

Package Diagrams

Figure 11. 48-Ball VFBGA (6 x 8 x 1 mm), 51-85150

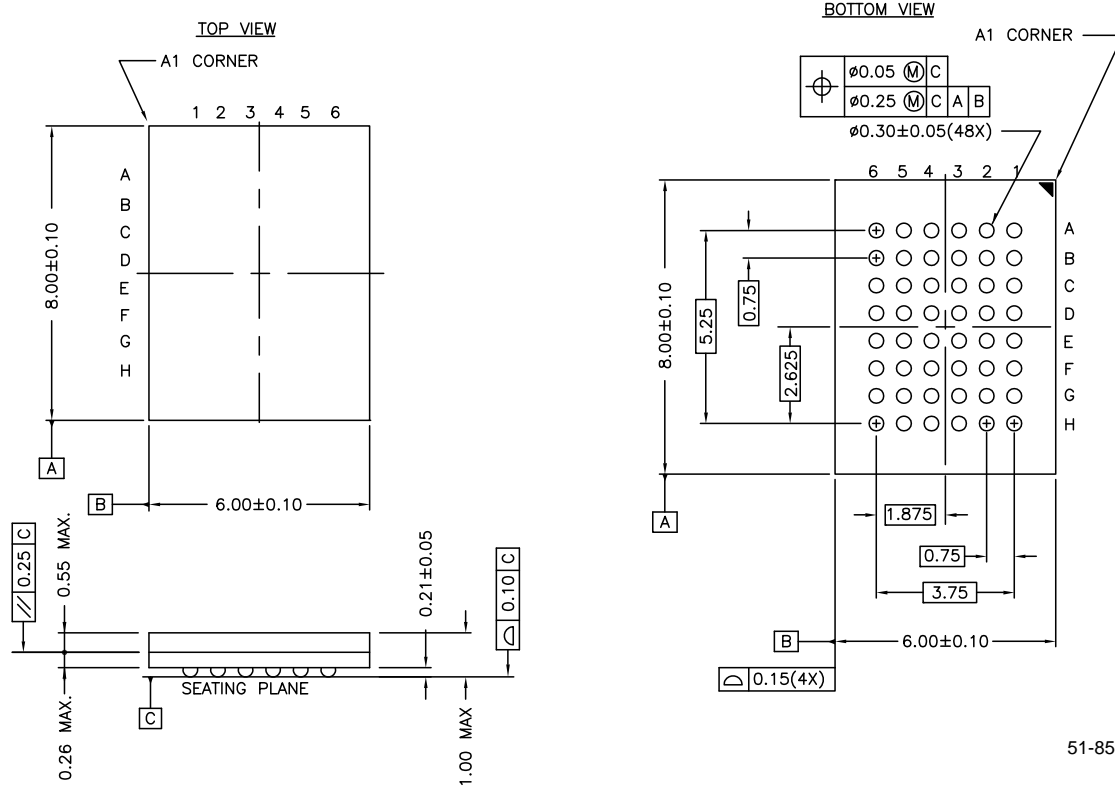
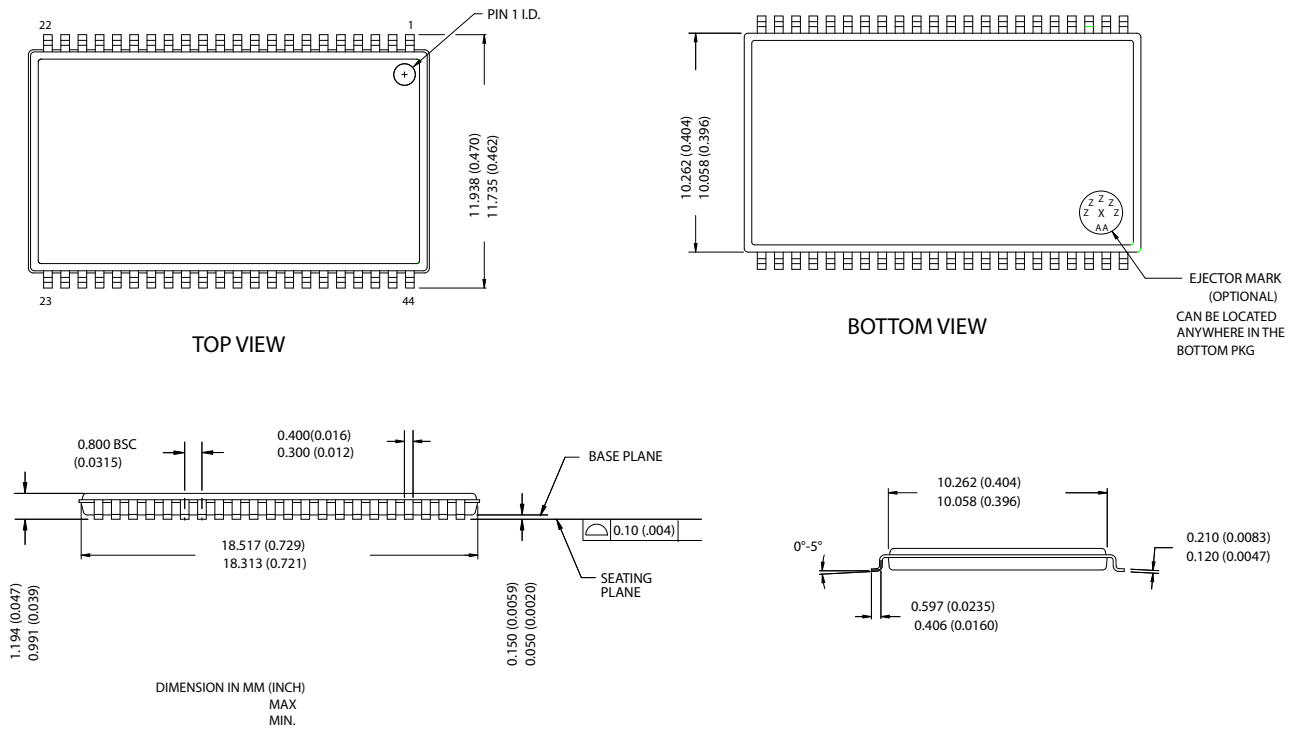

Figure 12. 44-Pin TSOP II, 51-85087



51-85087-°C

Acronyms

Acronym	Description
$\overline{\text{BHE}}$	byte high enable
$\overline{\text{BLE}}$	byte low enable
CMOS	complementary metal oxide semiconductor
$\overline{\text{CE}}$	chip enable
I/O	input/output
$\overline{\text{OE}}$	output enable
SRAM	static random access memory
TSOP	thin small outline package
VFBGA	very fine ball gird array
$\overline{\text{WE}}$	write enable

Document History Page

Document Title: CY62126EV30 MoBL®, 1-Mbit (64K x 16) Static RAM				
Document Number: 38-05486				
Rev.	ECN No.	Submission Date	Orig. of Change	Description of Change
**	202760	See ECN	AJU	New data sheet
*A	300835	See ECN	SYT	<p>Converted from Advance Information to Preliminary</p> <p>Specified Typical standby power in the Features Section</p> <p>Changed E3 ball from DNU to NC in the Pin Configuration for the FBGA Package and removed the footnote associated with it on page #2</p> <p>Changed t_{OHA} from 6 ns to 10 ns for both 35- and 45-ns speed bins, respectively</p> <p>Changed t_{DOE}, t_{SD} from 15 to 18 ns for 35-ns speed bin</p> <p>Changed t_{HZOE}, t_{HZBE}, t_{HZWE} from 12 and 15 ns to 15 and 18 ns for the 35- and 45-ns speed bins, respectively</p> <p>Changed t_{HZCE} from 12 and 15 ns to 18 and 22 ns for the 35- and 45-ns speed bins, respectively</p> <p>Changed t_{SCE}, t_{BW} from 25 and 40 ns to 30 and 35 ns for the 35- and 45-ns speed bins, respectively</p> <p>Changed t_{AW} from 25 to 30 ns and 40 to 35 ns for 35 and 45-ns speed bins respectively</p> <p>Changed t_{DBE} from 35 and 45 ns to 18 and 22 ns for the 35 and 45 ns speed bins respectively</p> <p>Removed footnote that read "BHE.BLE is the AND of both BHE and BLE. Chip can be deselected by either disabling the chip enable signals or by disabling both BHE and BLE" on page # 4</p> <p>Removed footnote that read "If both BHE and BLE are toggled together, then t_{LZBE} is 10 ns" on page # 5</p> <p>Added Pb-free package information</p>
*B	461631	See ECN	NXR	<p>Converted from Preliminary to Final</p> <p>Removed 35 ns Speed Bin</p> <p>Removed "L" version of CY62126EV30</p> <p>Changed $I_{CC(Typ)}$ from 8 mA to 11 mA and $I_{CC(max)}$ from 12 mA to 16 mA for $f = f_{max}$</p> <p>Changed $I_{CC(max)}$ from 1.5 mA to 2.0 mA for $f = 1$ MHz, I_{SB1}, $I_{SB2(max)}$ from 1 μA to 4 μA, I_{SB1}, $I_{SB2(Typ)}$ from 0.5 μA to 1 μA, $I_{CCDR(max)}$ from 1.5 μA to 3 μA, AC Test load Capacitance value from 50 pF to 30 pF, t_{LZOE} from 3 to 5 ns, t_{LZCE} from 6 to 10 ns, t_{HZCE} from 22 to 18 ns, t_{LZBE} from 6 to 5 ns, t_{PWE} from 30 to 35 ns, t_{SD} from 22 to 25 ns, t_{LZWE} from 6 to 10 ns, and updated the Ordering Information table.</p>
*C	925501	See ECN	VKN	<p>Added footnote #7 related to I_{SB2} and I_{CCDR}</p> <p>Added footnote #11 related AC timing parameters</p>
*D	1045260	See ECN	VKN	<p>Added Automotive information</p> <p>Updated Ordering Information table</p>
*E	2631771	01/07/09	NXR/PYRS	<p>Changed CE condition from X to L in Truth table for Output Disable mode</p> <p>Updated template</p>
*F	2944332	06/04/2010	VKN	<p>Added Contents</p> <p>Removed byte enable from footnote #2 in Electrical Characteristics</p> <p>Added footnote related to chip enable in Truth Table</p> <p>Updated Package Diagrams</p> <p>Updated links in Sales, Solutions, and Legal Information</p>
*G	2996166	07/29/2010	AJU	<p>Added CY62126EV30LL-45ZSXA part in Ordering Information.</p> <p>Added Ordering Code Definitions.</p> <p>Modified table footnote format.</p>
*H	3113864	12/17/2010	PRAS	Updated Figure 1 and Package Diagram, and fixed Typo in Figure 3..

Sales, Solutions, and Legal Information

Worldwide Sales and Design Support

Cypress maintains a worldwide network of offices, solution centers, manufacturer's representatives, and distributors. To find the office closest to you, visit us at [Cypress Locations](#).

Products

Automotive	cypress.com/go/automotive
Clocks & Buffers	cypress.com/go/clocks
Interface	cypress.com/go/interface
Lighting & Power Control	cypress.com/go/powerpsoc cypress.com/go/plc
Memory	cypress.com/go/memory
Optical & Image Sensing	cypress.com/go/image
PSoC	cypress.com/go/psoc
Touch Sensing	cypress.com/go/touch
USB Controllers	cypress.com/go/USB
Wireless/RF	cypress.com/go/wireless

PSoC Solutions

psoc.cypress.com/solutions
PSoC 1 | PSoC 3 | PSoC 5

© Cypress Semiconductor Corporation, 2008-2010. The information contained herein is subject to change without notice. Cypress Semiconductor Corporation assumes no responsibility for the use of any circuitry other than circuitry embodied in a Cypress product. Nor does it convey or imply any license under patent or other rights. Cypress products are not warranted nor intended to be used for medical, life support, life saving, critical control or safety applications, unless pursuant to an express written agreement with Cypress. Furthermore, Cypress does not authorize its products for use as critical components in life-support systems where a malfunction or failure may reasonably be expected to result in significant injury to the user. The inclusion of Cypress products in life-support systems application implies that the manufacturer assumes all risk of such use and in doing so indemnifies Cypress against all charges.

Any Source Code (software and/or firmware) is owned by Cypress Semiconductor Corporation (Cypress) and is protected by and subject to worldwide patent protection (United States and foreign), United States copyright laws and international treaty provisions. Cypress hereby grants to licensee a personal, non-exclusive, non-transferable license to copy, use, modify, create derivative works of, and compile the Cypress Source Code and derivative works for the sole purpose of creating custom software and or firmware in support of licensee product to be used only in conjunction with a Cypress integrated circuit as specified in the applicable agreement. Any reproduction, modification, translation, compilation, or representation of this Source Code except as specified above is prohibited without the express written permission of Cypress.

Disclaimer: CYPRESS MAKES NO WARRANTY OF ANY KIND, EXPRESS OR IMPLIED, WITH REGARD TO THIS MATERIAL, INCLUDING, BUT NOT LIMITED TO, THE IMPLIED WARRANTIES OF MERCHANTABILITY AND FITNESS FOR A PARTICULAR PURPOSE. Cypress reserves the right to make changes without further notice to the materials described herein. Cypress does not assume any liability arising out of the application or use of any product or circuit described herein. Cypress does not authorize its products for use as critical components in life-support systems where a malfunction or failure may reasonably be expected to result in significant injury to the user. The inclusion of Cypress' product in a life-support systems application implies that the manufacturer assumes all risk of such use and in doing so indemnifies Cypress against all charges.

Use may be limited by and subject to the applicable Cypress software license agreement.