

WIDEBAND POWER AMPLIFIER BENCHTOP MODULE, 0.01 - 15 GHz



Typical Applications

The HMC-C037 Wideband PA is ideal for:

- Lab Instrumentation
- Test Equipment

Features

- Gain: 12 dB
- P1dB Output Power: +28 dBm
- Eliminates Band Switching
- Excellent Gain Flatness
- Regulated Supply and Bias Sequencing
- Hermetically Sealed Module
- Field Replaceable SMA connectors
- 0 to +85°C Operating Temperature

General Description

The HMC-C037 is a GaAs MMIC PHEMT Power Amplifier in a benchtop, hermetic module with replaceable SMA connectors and integral heatsink which operates between 0.01 GHz and 15 GHz. The amplifier provides 12 dB of gain, up to +37 dBm output IP3 and up to +28 dBm of output power at 1 dB gain compression. Gain flatness is excellent at ± 0.3 dB from 2 - 12 GHz making the HMC-C037 ideal for general purpose lab instrumentation applications. The wideband amplifier I/Os are internally matched to 50 Ohms and are DC blocked. Integrated voltage regulators allow for flexible biasing of both the negative and positive supply pins, while internal bias sequencing circuitry assures robust operation.

Functional Diagram

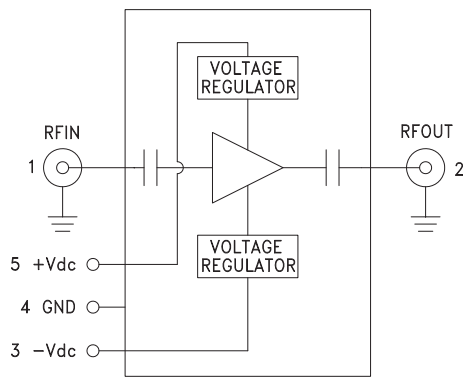

Electrical Specifications, $T_A = +25^\circ\text{C}$, +Vdc = +11V to +16V, -Vdc = -3V to -12V

Parameter	Min.	Typ.	Max.	Min.	Typ.	Max.	Min.	Typ.	Max.	Units
Frequency Range	0.5 - 6.0			6.0 - 12.0			12.0 - 15.0			GHz
Gain	9.5	12.5		9	12		8	11		dB
Gain Flatness		± 0.3			± 0.3			± 0.6		dB
Gain Variation Over Temperature		0.02			0.02			0.02		dB/°C
Noise Figure		4.5			4.0			7.0		dB
Input Return Loss		22			11			4		dB
Output Return Loss		13			12			10		dB
Output Power for 1 dB Compression (P1dB)	25	28		23	26		23	26		dBm
Saturated Output Power (Psat)		29			27			28		dBm
Output Third Order Intercept (IP3)		36			37			32		dBm
Positive Supply Current (+IDC)		360			360			360		mA
Negative Supply Current (-IDC)		-5.5			-5.5			-5.5		mA

Information furnished by Analog Devices is believed to be accurate and reliable. However, no responsibility is assumed by Analog Devices for its use, nor for any infringements of patents or other rights of third parties that may result from its use. Specifications subject to change without notice. No license is granted by implication or otherwise under any patent or patent rights of Analog Devices. Trademarks and registered trademarks are the property of their respective owners.

For price, delivery, and to place orders: Analog Devices, Inc., One Technology Way, P.O. Box 9106, Norwood, MA 02062-9106
Phone: 781-329-4700 • Order online at www.analog.com
Application Support: Phone: 1-800-ANALOG-D

HMC-C037* PRODUCT PAGE QUICK LINKS

Last Content Update: 02/23/2017

[COMPARABLE PARTS](#)

View a parametric search of comparable parts.

[DOCUMENTATION](#)

Application Notes

- AN-1363: Meeting Biasing Requirements of Externally Biased RF/Microwave Amplifiers with Active Bias Controllers

Data Sheet

- HMC-C037 Data Sheet

[DESIGN RESOURCES](#)

- HMC-C037 Material Declaration
- PCN-PDN Information
- Quality And Reliability
- Symbols and Footprints

[DISCUSSIONS](#)

View all HMC-C037 EngineerZone Discussions.

[SAMPLE AND BUY](#)

Visit the product page to see pricing options.

[TECHNICAL SUPPORT](#)

Submit a technical question or find your regional support number.

[DOCUMENT FEEDBACK](#)

Submit feedback for this data sheet.

**WIDEBAND POWER AMPLIFIER
BENCHTOP MODULE, 0.01 - 15 GHz**

Gain & Return Loss

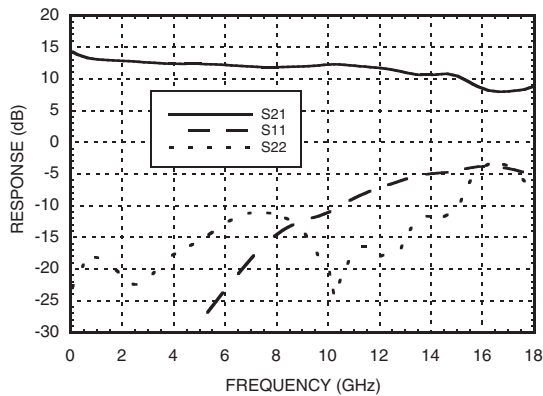

Gain vs. Temperature

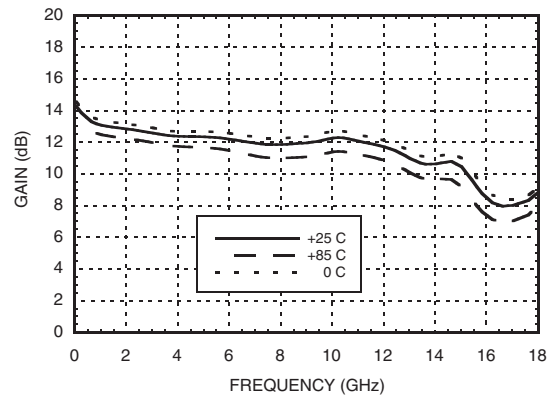

Input Return Loss vs. Temperature

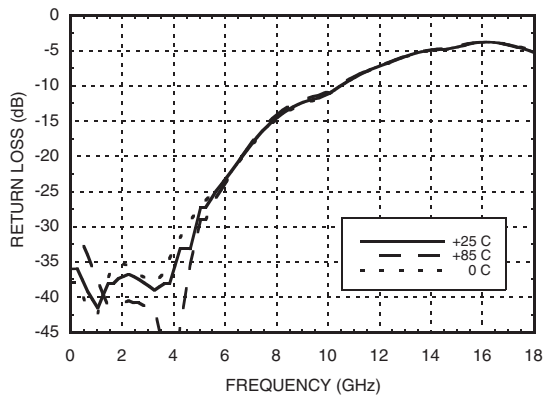

Output Return Loss vs. Temperature

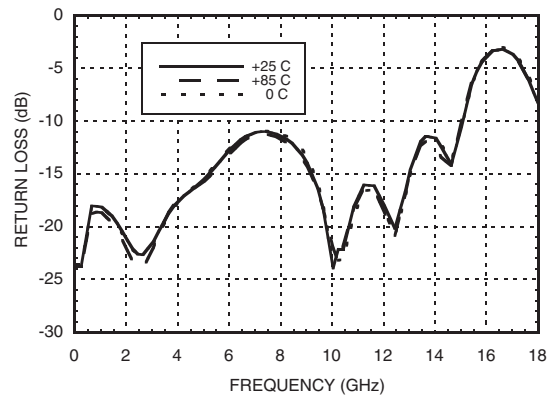

Reverse Isolation vs. Temperature

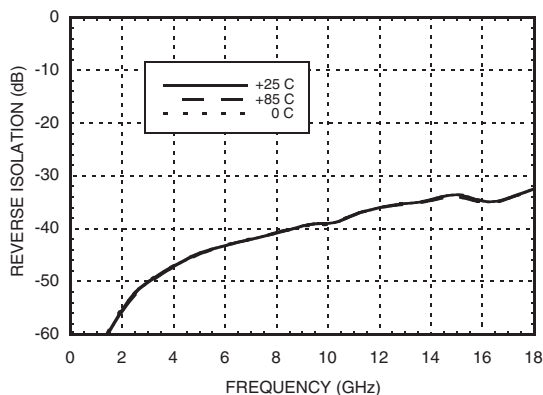

Noise Figure vs. Temperature

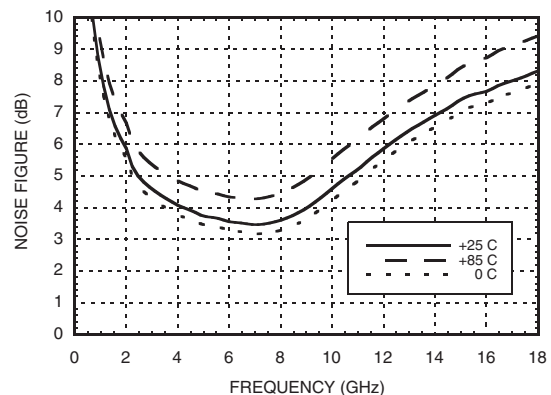

Information furnished by Analog Devices is believed to be accurate and reliable. However, no responsibility is assumed by Analog Devices for its use, nor for any infringements of patents or other rights of third parties that may result from its use. Specifications subject to change without notice. No license is granted by implication or otherwise under any patent or patent rights of Analog Devices. Trademarks and registered trademarks are the property of their respective owners.

For price, delivery, and to place orders: Analog Devices, Inc., One Technology Way, P.O. Box 9106, Norwood, MA 02062-9106 Phone: 781-329-4700 • Order online at www.analog.com Application Support: Phone: 1-800-ANALOG-D

**WIDEBAND POWER AMPLIFIER
BENCHTOP MODULE, 0.01 - 15 GHz**

P1dB vs. Temperature

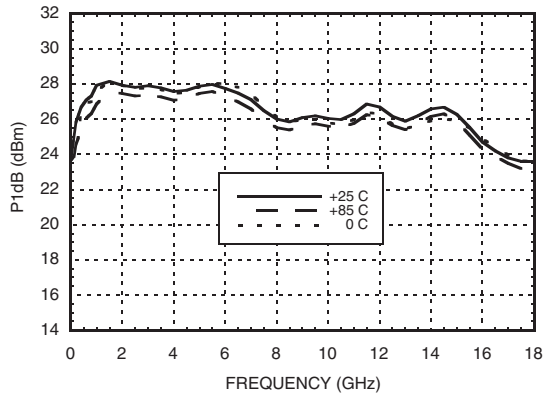

Psat vs. Temperature

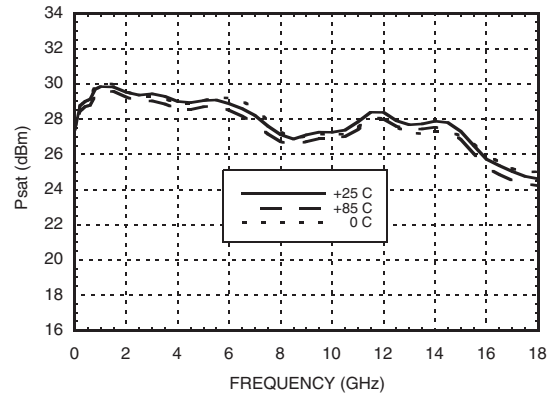

Output IP3 vs. Temperature

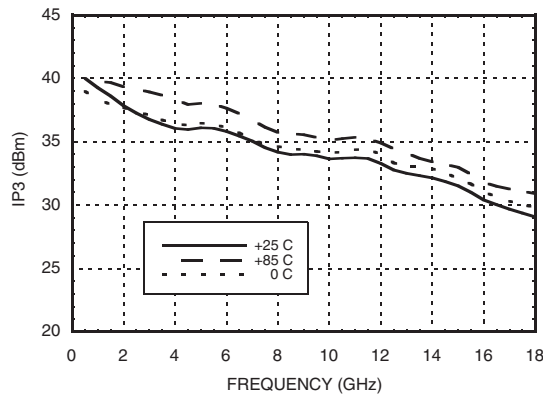

Group Delay

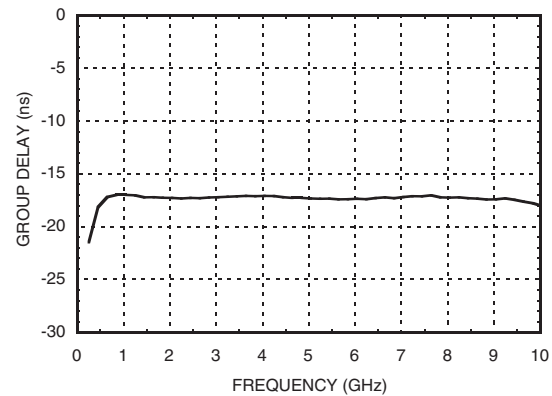

Deviation from Linear Phase

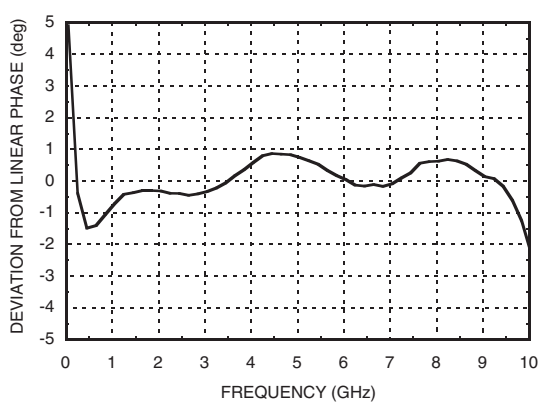

Low Frequency Gain & Return Loss

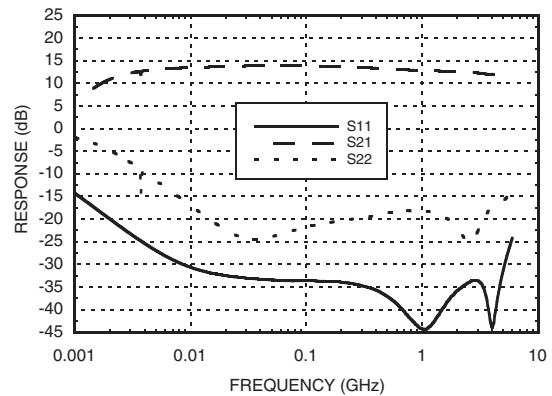

Information furnished by Analog Devices is believed to be accurate and reliable. However, no responsibility is assumed by Analog Devices for its use, nor for any infringements of patents or other rights of third parties that may result from its use. Specifications subject to change without notice. No license is granted by implication or otherwise under any patent or patent rights of Analog Devices. Trademarks and registered trademarks are the property of their respective owners.

For price, delivery, and to place orders: Analog Devices, Inc., One Technology Way, P.O. Box 9106, Norwood, MA 02062-9106 Phone: 781-329-4700 • Order online at www.analog.com Application Support: Phone: 1-800-ANALOG-D

WIDEBAND POWER AMPLIFIER BENCHTOP MODULE, 0.01 - 15 GHz



Absolute Maximum Ratings

Positive Bias Supply Voltage (+Vdc)	+17V Max
Negative Bias Supply (-Vdc)	-16V Min.
Maximum RF Input Power	
Peak	24 dBm
CW @ 0.01 - 6 GHz	22 dBm
CW @ 6 - 12 GHz	21 dBm
CW @ 12 - 20 GHz	18 dBm
Storage Temperature	-65 to +150 °C
Operating Temperature	0 to +85 °C

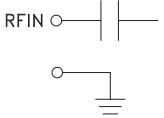
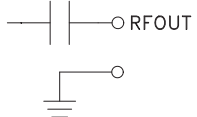
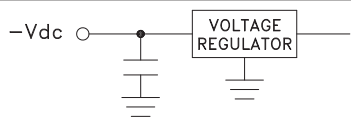

ELECTROSTATIC SENSITIVE DEVICE
OBSERVE HANDLING PRECAUTIONS

Pin Descriptions

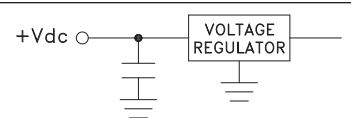
Pin Number	Function	Description	Interface Schematic
1	RFIN & RF Ground	RF input connector, SMA female, field replaceable. This pin is AC coupled and matched to 50 Ohms.	
2	RFOUT & RF Ground	RF output connector, SMA female. This pin is AC coupled and matched to 50 Ohms.	
3	-Vdc	Negative power supply voltage for the amplifier	
4	GND	Power supply ground.	
5	+Vdc	Positive power supply voltage for the amplifier.	

**WIDEBAND POWER AMPLIFIER
BENCHTOP MODULE, 0.01 - 15 GHz**

Outline Drawing

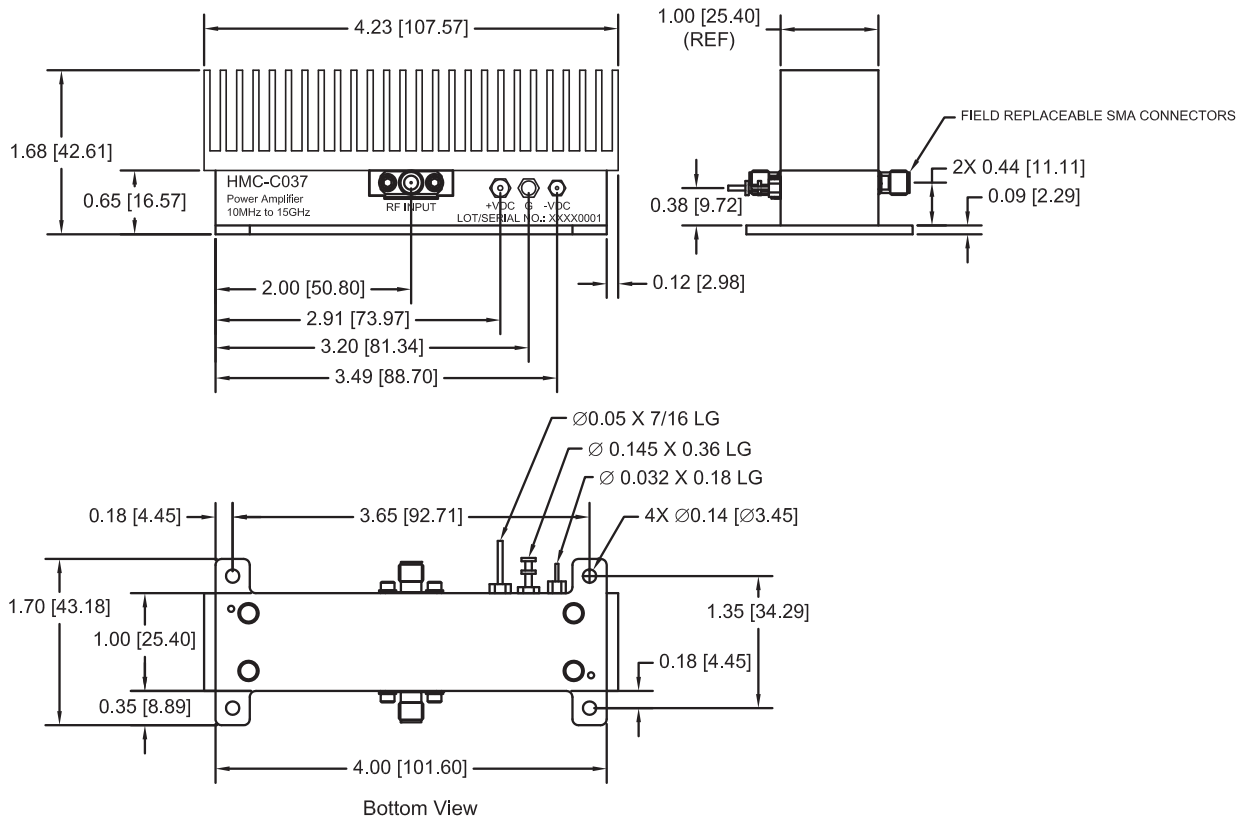

Package Information

Package Type	C-12
Package Weight ^[1]	164.2 gms ^[2]
Spacer Weight	N/A

[1] Includes the connectors

[2] ± 16 gms Tolerance

NOTES:

1. PACKAGE: ALUMINUM.
2. FINISH: (HEATSINK) ANODIZED, (HOUSING AND BASEPLATE): IRIDITE CHEMICAL FILM PER MIL-C-5541 CLASS C.
3. ALL DIMENSIONS ARE IN INCHES [MILLIMETERS].
4. TOLERANCES: ± 0.010 [0.25] UNLESS OTHERWISE SPECIFIED

**WIDEBAND POWER AMPLIFIER
BENCHTOP MODULE, 0.01 - 15 GHz****Notes:**