



**GaAs MMIC VOLTAGE-VARIABLE
ATTENUATOR, 5 - 30 GHz**

Typical Applications

The HMC812LC4 is ideal for:

- Point-to-Point Radio
- VSAT Radio
- Test Instrumentation
- Microwave Sensors
- Military, ECM & Radar

Features

- Wide Bandwidth: 5 - 30 GHz
- Excellent Linearity: +28 dBm Input IP3
- High Power Handling: +25 dBm Input P1dB
- Wide Attenuation Range: 30 dB
- 24 Lead Ceramic 4x4 mm SMT Package: 16mm²

Functional Diagram

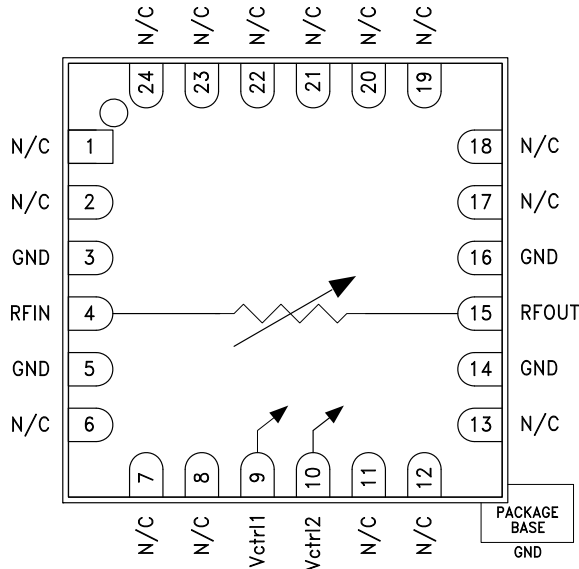

General Description

The HMC812LC4 is an absorptive Voltage Variable Attenuator (VVA) which operates from 5 - 30 GHz and is ideal in designs where an analog DC control signal must be used to control RF signal levels over a 30 dB amplitude range. It features two shunt-type attenuators which are controlled by two analog voltages, Vctrl1 and Vctrl2. Optimum linearity performance of the attenuator is achieved by first varying Vctrl1 of the 1st attenuation stage from -3V to 0V with Vctrl2 fixed at -3V. The control voltage of the 2nd attenuation stage, Vctrl2, should then be varied from -3V to 0V, with Vctrl1 fixed at 0V. The HMC812LC4 is housed in a RoHS compliant 4x4 mm QFN leadless ceramic package

However, if the Vctrl1 and Vctrl2 pins are connected together it is possible to achieve the full analog attenuation range with only a small degradation in input IP3 performance. Applications include AGC circuits and temperature compensation of multiple gain stages in microwave point-to-point and VSAT radios.

Electrical Specifications, $T_A = +25^\circ C$, 50 Ohm system

Parameter	Min.	Typ.	Max.	Units
Insertion Loss		5 - 16 GHz	2	dB
		16 - 24 GHz	3	dB
		24 - 30 GHz	4	dB
Attenuation Range		30		dB
Input Return Loss		12		dB
Output Return Loss		8		dB
Input Power for 1 dB Compression (any attenuation)		25		dBm
Input Third Order Intercept (Two-tone Input Power = 10 dBm Each Tone)		28		dBm

Information furnished by Analog Devices is believed to be accurate and reliable. However, no responsibility is assumed by Analog Devices for its use, nor for any infringements of patents or other rights of third parties that may result from its use. Specifications subject to change without notice. No license is granted by implication or otherwise under any patent or patent rights of Analog Devices. Trademarks and registered trademarks are the property of their respective owners.

For price, delivery, and to place orders: Analog Devices, Inc., One Technology Way, P.O. Box 9106, Norwood, MA 02062-9106 Phone: 781-329-4700 • Order online at www.analog.com Application Support: Phone: 1-800-ANALOG-D

HMC812* PRODUCT PAGE QUICK LINKS

Last Content Update: 02/23/2017

COMPARABLE PARTS

View a parametric search of comparable parts.

EVALUATION KITS

- HMC812LC4 Evaluation Board

DOCUMENTATION

Data Sheet

- HMC812 Data Sheet

TOOLS AND SIMULATIONS

- HMC812 S-Parameter

REFERENCE MATERIALS

Quality Documentation

- Package/Assembly Qualification Test Report: LC4, LC4B (QTR: 2014-00380 REV: 01)

DESIGN RESOURCES

- HMC812 Material Declaration
- PCN-PDN Information
- Quality And Reliability
- Symbols and Footprints

DISCUSSIONS

View all HMC812 EngineerZone Discussions.

SAMPLE AND BUY

Visit the product page to see pricing options.

TECHNICAL SUPPORT

Submit a technical question or find your regional support number.

DOCUMENT FEEDBACK

Submit feedback for this data sheet.



**GaAs MMIC VOLTAGE-VARIABLE
ATTENUATOR, 5 - 30 GHz**

Attenuation vs. Frequency over Vctrl1
Vctrl1 = Variable, Vctrl2 = -3V

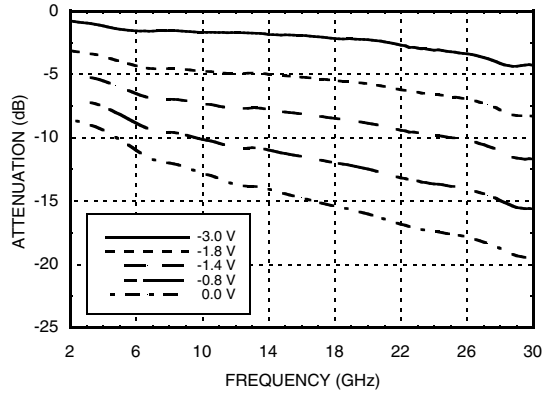

Attenuation vs. Frequency over Vctrl1
Vctrl1 = 0V, Vctrl2 = Variable

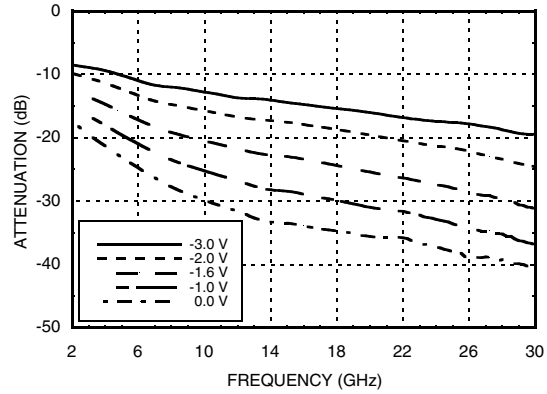

Attenuation vs. Vctrl1
Over Temperature @ 10 GHz, Vctrl2 = -3V

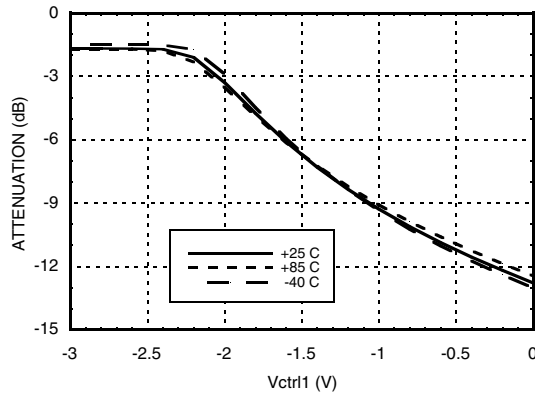

Attenuation vs. Vctrl2
Over Temperature @ 10 GHz, Vctrl1 = 0V

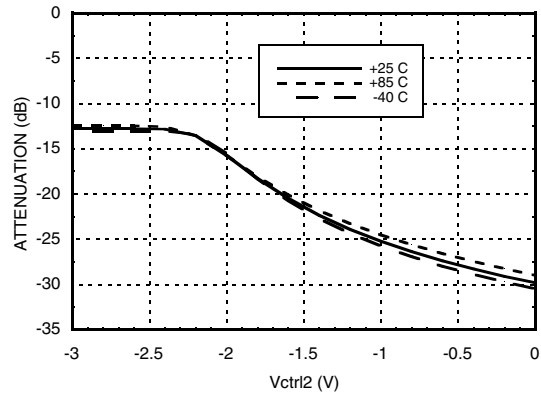

Attenuation vs. Pin @ 10 GHz
Vctrl1 = Variable, Vctrl2 = -3V

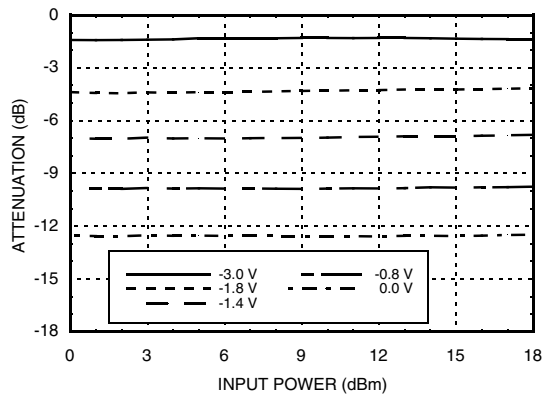

Input Return Loss
Vctrl1 = Variable, Vctrl2 = -3V

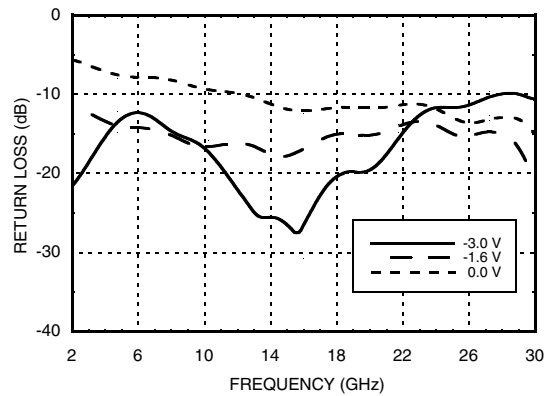



**GaAs MMIC VOLTAGE-VARIABLE
ATTENUATOR, 5 - 30 GHz**

Input Return Loss

Vctrl1 = 0V, Vctrl2 = Variable

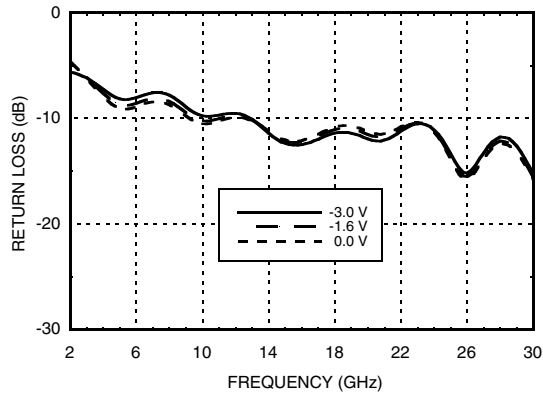

Output Return Loss

Vctrl1 = Variable, Vctrl2 = -3V

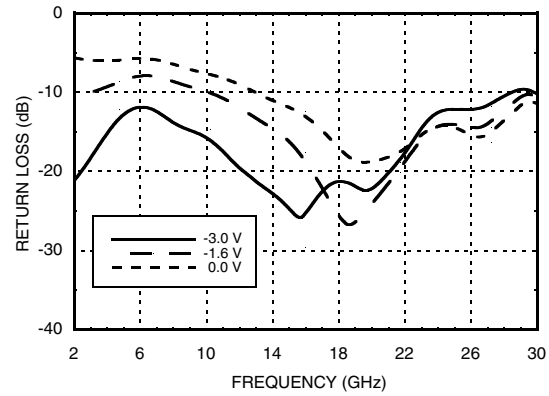

Output Return Loss

Vctrl1 = 0V, Vctrl2 = Variable

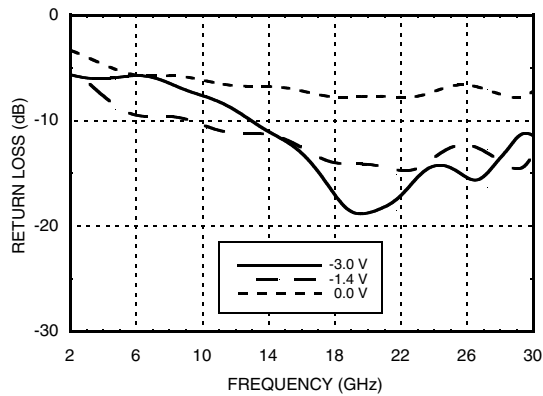

Input IP3 vs Input Power @ 10 GHz

Vctrl1 = Variable, Vctrl2 = -3V

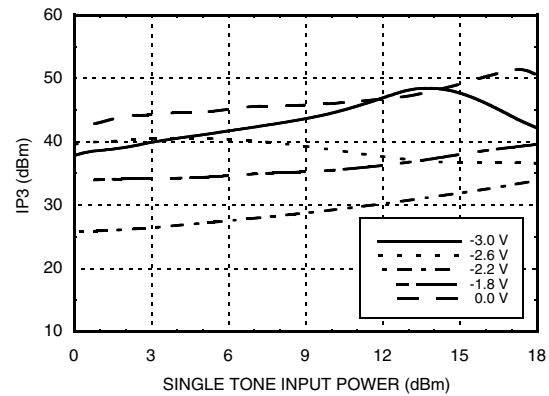

**Input IP3 vs. Input Power Over Frequency
Vctrl1 = -2.2V, Vctrl2 = -3V (Worst Case IP3)**

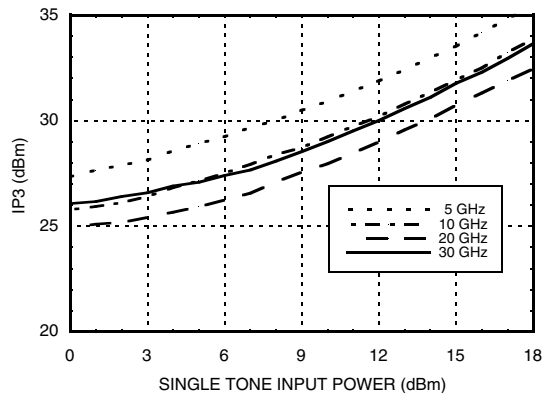

**Input IP3 vs. Input Power Over Temperature
@ 10 GHz, Vctrl1 = -2.2V, Vctrl2 = -3V**

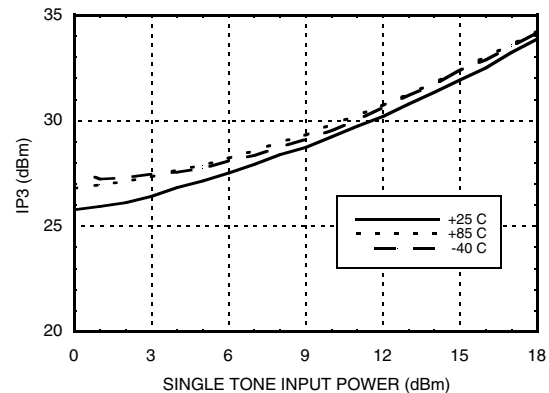

Information furnished by Analog Devices is believed to be accurate and reliable. However, no responsibility is assumed by Analog Devices for its use, nor for any infringements of patents or other rights of third parties that may result from its use. Specifications subject to change without notice. No license is granted by implication or otherwise under any patent or patent rights of Analog Devices. Trademarks and registered trademarks are the property of their respective owners.

For price, delivery, and to place orders: Analog Devices, Inc., One Technology Way, P.O. Box 9106, Norwood, MA 02062-9106 Phone: 781-329-4700 • Order online at www.analog.com Application Support: Phone: 1-800-ANALOG-D



GaAs MMIC VOLTAGE-VARIABLE ATTENUATOR, 5 - 30 GHz

Attenuation vs. Frequency over Vctrl
Vctrl1 = Vctrl2

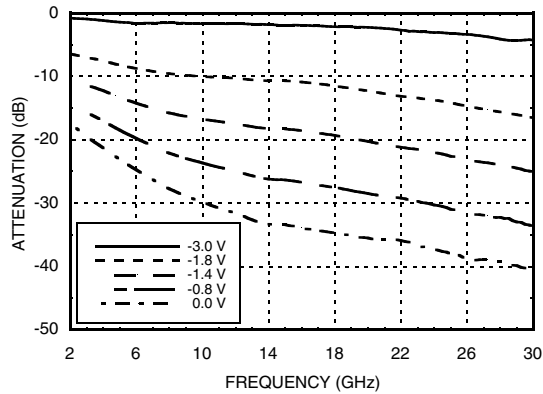

Attenuation vs. Vctrl over Temperature
@ 10 GHz, Vctrl1 = Vctrl2

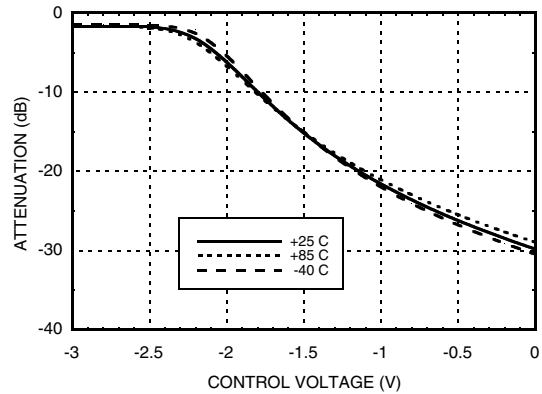

Attenuation vs. Input Power over Vctrl
Vctrl1 = Vctrl2

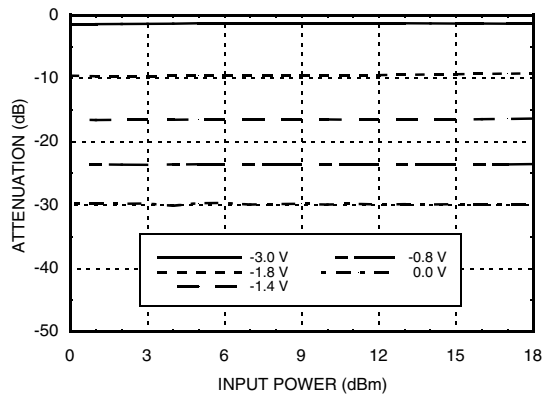

Input Return Loss, Vctrl1 = Vctrl2

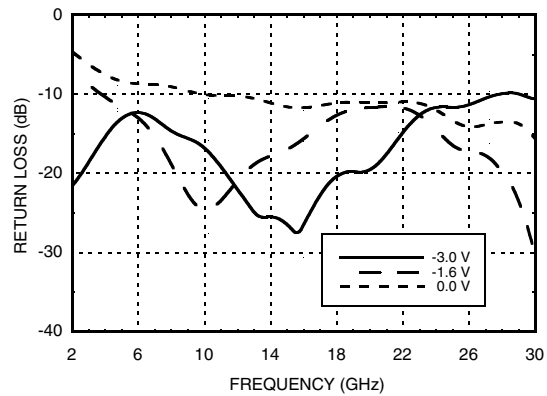

Output Return Loss, Vctrl1 = Vctrl2

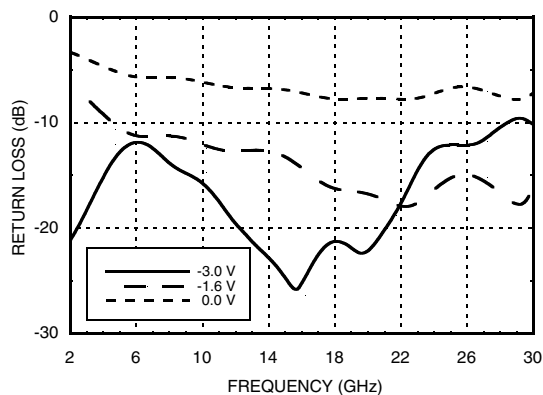

Input IP3 vs. Input Power Over Vctrl @ 10 GHz, Vctrl1 = Vctrl2

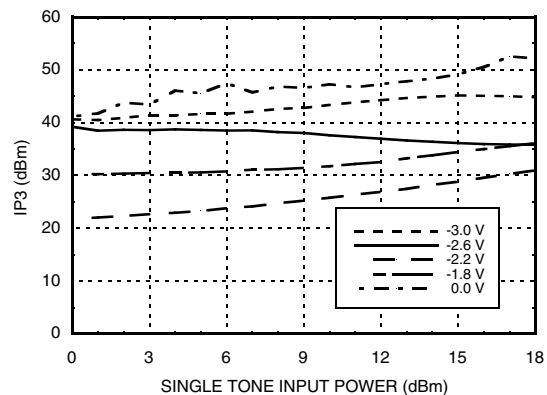

Information furnished by Analog Devices is believed to be accurate and reliable. However, no responsibility is assumed by Analog Devices for its use, nor for any infringements of patents or other rights of third parties that may result from its use. Specifications subject to change without notice. No license is granted by implication or otherwise under any patent or patent rights of Analog Devices. Trademarks and registered trademarks are the property of their respective owners.

For price, delivery, and to place orders: Analog Devices, Inc., One Technology Way, P.O. Box 9106, Norwood, MA 02062-9106 Phone: 781-329-4700 • Order online at www.analog.com Application Support: Phone: 1-800-ANALOG-D



GaAs MMIC VOLTAGE-VARIABLE ATTENUATOR, 5 - 30 GHz

Absolute Maximum Ratings

RF Input Power	+30 dBm
Control Voltage Range	+1 to -5V
Channel Temperature	150 °C
Continuous Pdiss (T = 85 °C) (derate 16.4 mW/°C above 85 °C)	1.07 W
Thermal Resistance (Channel to ground paddle)	61 °C/W
Storage Temperature	-65 to +150 °C
Operating Temperature	-40 to +85 °C

Control Voltages

Vctrl1	-3 to 0V @ 10 μA
Vctrl2	-3 to 0V @ 10 μA



ELECTROSTATIC SENSITIVE DEVICE
OBSERVE HANDLING PRECAUTIONS

Outline Drawing

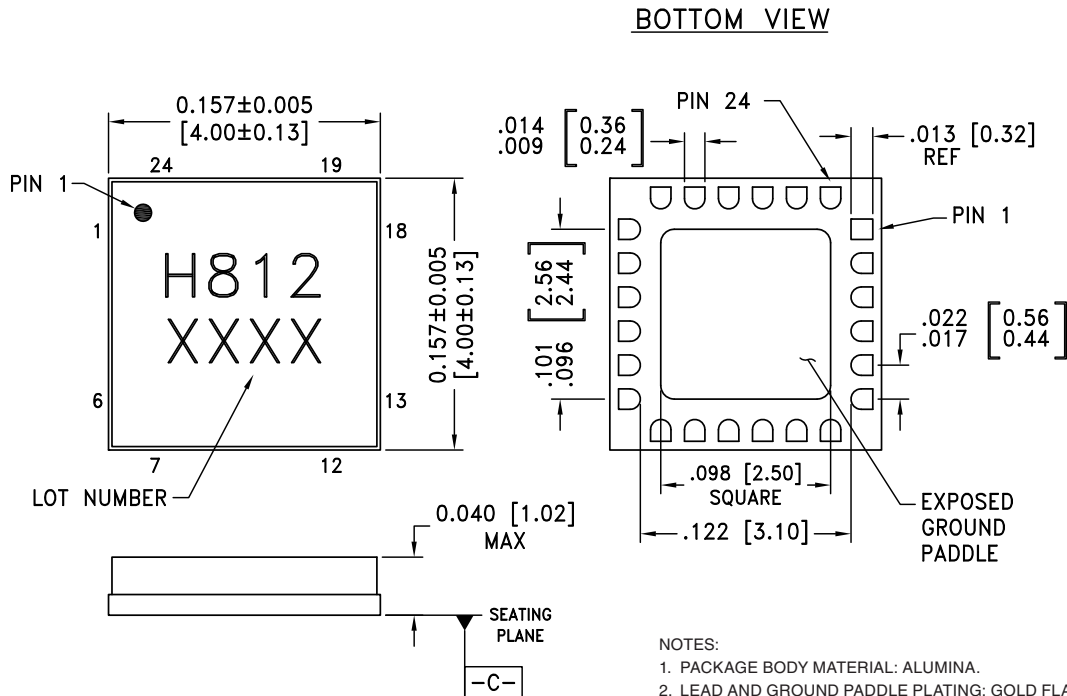

NOTES:

1. PACKAGE BODY MATERIAL: ALUMINA.
2. LEAD AND GROUND PADDLE PLATING: GOLD FLASH OVER NICKEL.
3. DIMENSIONS ARE IN INCHES (MILLIMETERS).
4. LEAD SPACING TOLERANCE IS NON-CUMULATIVE.
5. PACKAGE WARP SHALL NOT EXCEED 0.05MM DATUM $\square-C-$
6. ALL GROUND LEADS AND GROUND PADDLE MUST BE SOLDERED TO PCB RF GROUND.

Package Information

Part Number	Package Body Material	Lead Finish	MSL Rating	Package Marking ^[2]
HMC812LC4	Alumina, White	Gold over Nickel	MSL3 ^[1]	H812 XXXX

[1] Max peak reflow temperature of 260 °C

[2] 4-Digit lot number XXXX

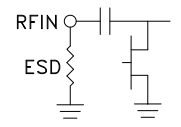
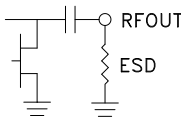
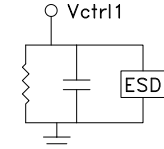
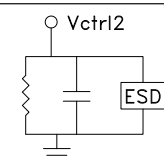

**GaAs MMIC VOLTAGE-VARIABLE
ATTENUATOR, 5 - 30 GHz**
Pin Descriptions

Pin Number	Function	Description	Interface Schematic
1, 2, 6 - 8, 11 - 13, 17 - 24	N/C	These pins are not connected internally, however these pins must be connected to RF/DC ground externally.	
3, 5, 14, 16	GND	These pins and the exposed ground paddle must be connected to RF/DC ground.	
4	RFIN	This pad is DC coupled and matched to 50 Ohms. A blocking capacitor is required if RF line potential is not equal to 0V.	
15	RFOUT		
9	Vctrl1	Control Voltage 1	
10	Vctrl2	Control Voltage 2	

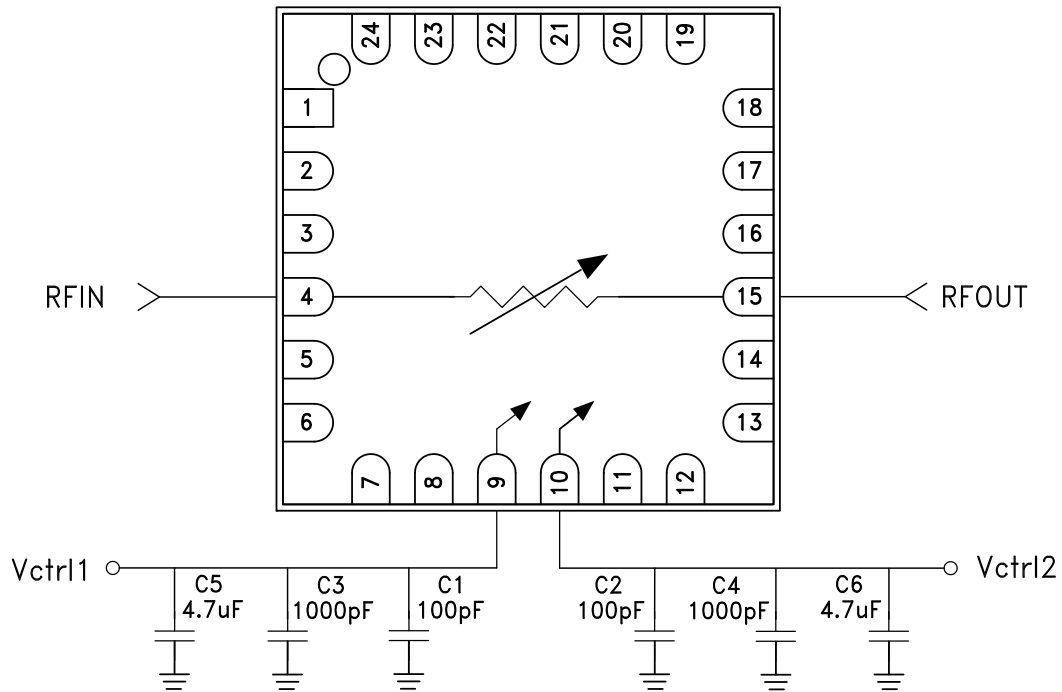

**GaAs MMIC VOLTAGE-VARIABLE
ATTENUATOR, 5 - 30 GHz**

Application Circuit



Information furnished by Analog Devices is believed to be accurate and reliable. However, no responsibility is assumed by Analog Devices for its use, nor for any infringements of patents or other rights of third parties that may result from its use. Specifications subject to change without notice. No license is granted by implication or otherwise under any patent or patent rights of Analog Devices. Trademarks and registered trademarks are the property of their respective owners.

For price, delivery, and to place orders: Analog Devices, Inc., One Technology Way, P.O. Box 9106, Norwood, MA 02062-9106 Phone: 781-329-4700 • Order online at www.analog.com Application Support: Phone: 1-800-ANALOG-D



**GaAs MMIC VOLTAGE-VARIABLE
ATTENUATOR, 5 - 30 GHz**

Evaluation PCB

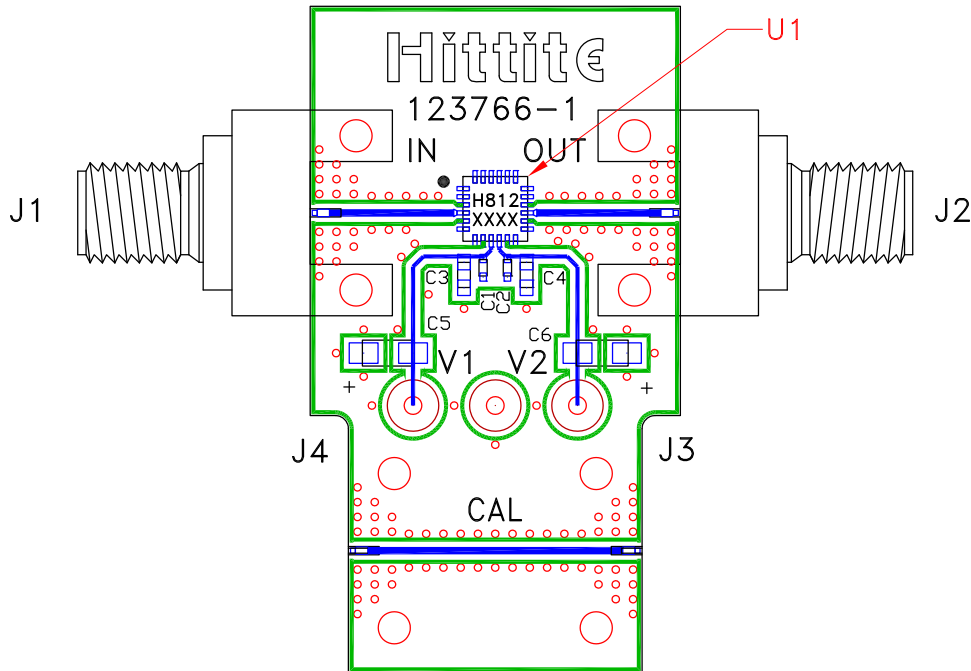

List of Materials for Evaluation PCB 123768 [1]

Item	Description
J1, J2	2.9 mm PC Mount RF Connector
J3, J4	DC Pin
C1, C2	100 pF Capacitor, 0402 Pkg.
C3, C4	1000 pF Capacitor, 0402 Pkg.
C5, C6	4.7 μF Capacitor, CASE A
U1	HMC812LC4 Analog VVA
PCB [2]	123766 Evaluation PCB

[1] Reference this number when ordering complete evaluation PCB

[2] Circuit Board Material: Arlon 25FR or Rogers 4350

The circuit board used in the final application should use RF circuit design techniques. Signal lines should have 50 Ohm impedance while the package ground leads and exposed paddle should be connected directly to the ground plane similar to that shown. A sufficient number of via holes should be used to connect the top and bottom ground planes. The evaluation circuit board shown is available from Hittite upon request.