

	DESCRIPTION OF REVISIONS	BY	CHKD	DATE	COUNT	DESCRIPTION OF REVISIONS	BY	CHKD	DATE
△					△				
△					△				
APPLICABLE STANDARD									
RATING	OPERATING TEMPERATURE RANGE	- 35 °C TO 85 °C(NOTE1)			STORAGE TEMPERATURE RANGE	- 10 °C TO 60 °C			
	VOLTAGE	30 V AC			APPLICABLE CONNECTOR	DF30*-*DS-0.4V (**)			
	CURRENT	0.3 A							
SPECIFICATIONS									
ITEM		TEST METHOD			REQUIREMENTS			QT	AT
CONSTRUCTION									
GENERAL EXAMINATION		VISUALLY AND BY MEASURING INSTRUMENT.			ACCORDING TO DRAWING.			X	X
MARKING		CONFIRMED VISUALLY.						X	X
ELECTRICAL CHARACTERISTICS									
CONTACT RESISTANCE		100 mA (DC OR 1000 Hz).			100 mΩ MAX.			X	-
INSULATION RESISTANCE		100 V DC.			50 MΩ MIN.			X	-
VOLTAGE PROOF		100 V AC FOR 1 min.			NO FLASHOVER OR BREAKDOWN.			X	-
MECHANICAL CHARACTERISTICS									
MECHANICAL OPERATION		500 TIMES INSERTIONS AND EXTRACTIONS.			① CONTACT RESISTANCE: 100mΩ MAX. ② NO DAMAGE, CRACK AND LOOSENESS, OF PARTS.			X	-
VIBRATION		FREQUENCY 10 TO 55 Hz, SINGLE AMPLITUDE 0.75 mm, 10 CYCLES OF EACH 3 AXIAL DIRECTION FOR 5 min.			① NO ELECTRICAL DISCONTINUITY OF 1 μs. ② NO DAMAGE, CRACK AND LOOSENESS, OF PARTS.			X	-
SHOCK		490 m/s ² DURATION OF PULSE 11 ms AT 3 TIMES FOR 3 DIRECTIONS.			① NO ELECTRICAL DISCONTINUITY OF 1 μs. ② NO DAMAGE, CRACK AND LOOSENESS, OF PARTS.			X	-
ENVIRONMENTAL CHARACTERISTICS									
DAMP HEAT (STEADY STATE)		EXPOSED AT 40±2 °C, 90 TO 95 %, 96 h.			① CONTACT RESISTANCE: 100mΩ MAX. ② INSULATION RESISTANCE: 25MΩ MIN. ③ NO DAMAGE, CRACK AND LOOSENESS, OF PARTS.			X	-
RAPID CHANGE OF TEMPERATURE		TEMPERATURE -55→ 5 TO 35→85→ 5 TO 35 °C TIME 30→10 TO 15→30→10 TO 15 min UNDER 5 CYCLES.			① CONTACT RESISTANCE: 100mΩ MAX. ② INSULATION RESISTANCE: 50MΩ MIN. ③ NO DAMAGE, CRACK AND LOOSENESS, OF PARTS.			X	-
CORROSION SALT MIST		EXPOSED IN 5% SALT WATER SPRAY FOR 48 h. (TEST STANDARD:IEC60068)			① CONTACT RESISTANCE: 100mΩ MAX. ② NO HEAVY CORROSION.			X	-
SULPHUR DIOXIDE		EXPOSED IN 25 PPM FOR 96h. (TEST STANDARD:IEC60068)			① CONTACT RESISTANCE: 100mΩ MAX. ② NO HEAVY CORROSION.			X	-
REMARKS NOTE1: INCLUDE THE TEMPERATURE RISING BY CURRENT. Unless otherwise specified, refer to IEC60512.				DRAWN T.Nishi 03.08.06	DESIGNED W. Fukuchi 03.08.19	CHECKED J. Tomida 03.08.19	APPROVED J. Ona 03.08.19	RELEASED	
Note QT: Qualification Test AT: Assurance Test X: Applicable Test									
HRS HIROSE ELECTRIC CO., LTD.				SPECIFICATION SHEET			PART NO. DF30CJ-*DP-0.4V (52)		
CODE NO.(OLD) CL		DRAWING NO. ELC4-304055-02			CODE NO. CL684-*****-52			1/1	

Apr.1.2017 Copyright 2017 HIROSE ELECTRIC CO., LTD. All Rights Reserved.

TO



1	2		3		4				
COUNT	DESCRIPTION OF REVISIONS	BY	CHKD	DATE	COUNT	DESCRIPTION OF REVISIONS	BY	CHKD	DATE
△	4	RE-H-06664	YM	TS	04.12.17	△			. .
△						△			. .
△						△			. .

■ NOTES WHEN MATING DF30 SERIES CONNECTORS.

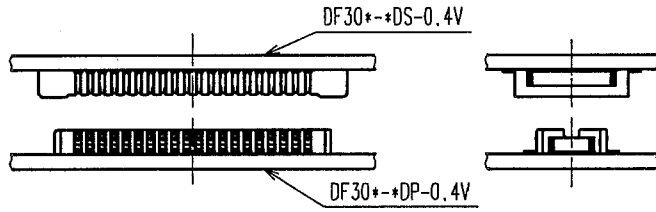

FIGURE-1

PLEASE LOCATE EACH CONNECTOR IN PARALLEL WHEN YOU PUT THEM IN MATING POSITION.

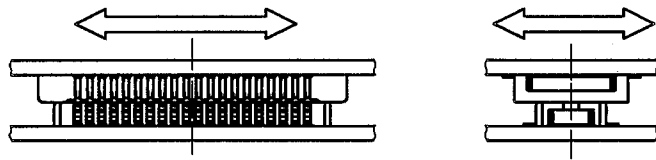

FIGURE-2

THE INSULATOR WILL BE DAMAGED AND THE CONTACTS WILL BE DEFORMED IF THE CONNECTORS ARE LOCATED INCLINED AND MATED BY EXCESSIVE FORCE.

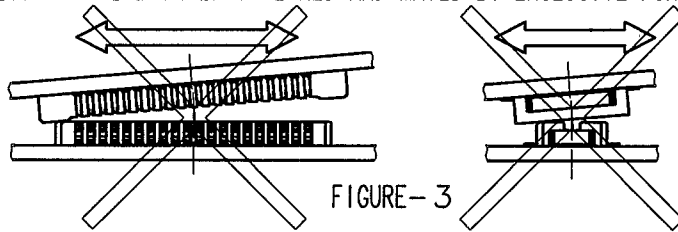

FIGURE-3

WHEN YOU LOCATE TWO CONNECTORS IN A PROPER POSITION, THEY WILL GO DOWN SLIGHTLY AT A LOWER LEVEL AND YOU WILL FIND THAT THEY GET LOCATED CORRECTLY. PLEASE MATE EACH CONNECTOR IN PARALLEL AFTER YOU CONFIRMED THAT THEY GO DOWN LOWER TO SOME EXTENT.

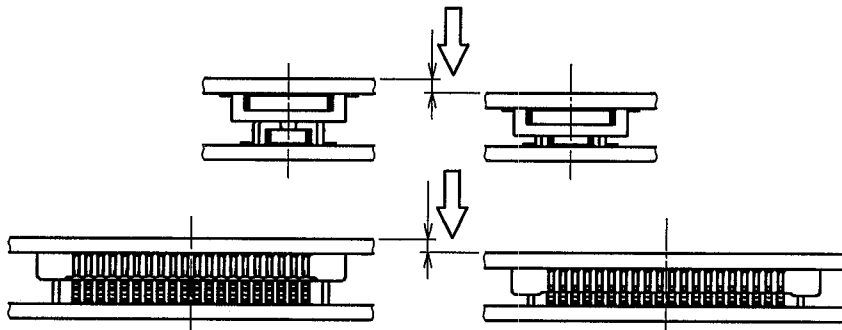

FIGURE-4

THE MATED CONDITIONS CAN BE RELEASED BY A DROP IMPACT OR THE APPLIED FORCE CAUSED BY FPC-HANDLING. FIX THE CONNECTORS BY APPLYING PRESSURE IN THE MATING DIRECTION WITH THE DEVICE OR A BUFFER MATERIAL.

CODE NO. (OLD)		DRAWN	DESIGNED	CHECKED	APPROVED	RELEASED
		Y.MICHIDA	A.TAKAHASHI	T.SAKATA	T.OMA	
NOTES WHEN MATING		04.12.16	04.12.16	04.12.16	04.12.16	
 SCALE FREE : 1 UNITS mm	DRAWING NO.		PART NO.			
	EDSC4-830174		DF30 Series			
 HIROSE ELECTRIC CO., LTD.		CODE NO.				
		CL684			1/3	

1			2			3			4					
COUNT	DESCRIPTION OF REVISIONS	BY	CHKD	DATE	COUNT	DESCRIPTION OF REVISIONS	BY	CHKD	DATE	COUNT	DESCRIPTION OF REVISIONS	BY	CHKD	DATE
△					△									.
△					△									.
△					△									.

■ NOTES WHEN EXTRACTING

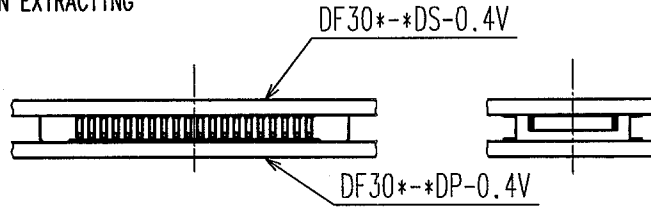

FIGURE-5

WHEN YOU EXTRACT CONNECTORS, PLEASE EXTRACT IN PARALLEL.

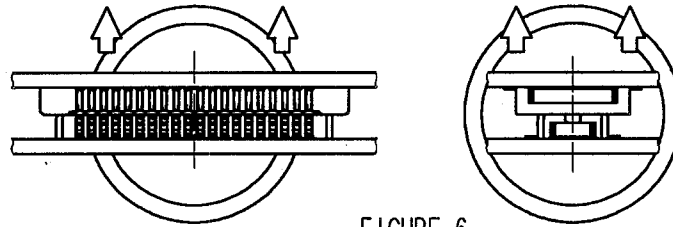

FIGURE-6

⚠ IF YOU'RE UNABLE TO EXTRACT IN PARALLEL DUE TO SET STRUCTURE OR SPACE, PLEASE EXTRACT AS FIGURE-7 (IN LONGER DIMENSION). PLEASE BE CAREFUL NOT TO DAMAGE CONTACTS AT SIDES, WHERE STRESS IS LIKELY TO GATHER WHEN CONNECTORS ARE MOUNTED ON SOFT FPC.

⚠ ESPECIALLY, PLEASE DO NOT EXTRACT FROM THE CORNER AS FIGURE-8. IT GIVES CRITICAL STRESS TO THE CONTACTS ON THE CROSS CORNER.

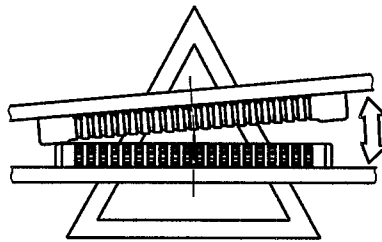

FIGURE-7

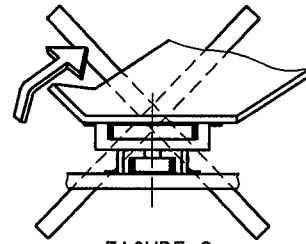

FIGURE-8

⚠ PLEASE DO NOT EXTRACT AS FIGURE-9. THE STRESS CONCENTRATES ON ONE ROW, AND MIGHT DAMAGE CONNECTORS TO MALFUNCTION.

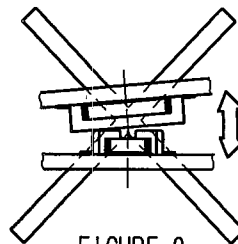

FIGURE-9

CODE NO. (OLD)		DRAWN	DESIGNED	CHECKED	APPROVED	RELEASED
		Y.MICHIDA	A.TAKAHASHI	T.SAKATA	T.OMA	
NOTES WHEN EXTRACTING		04.12.16	04.12.16	04.12.16	04.12.16	
 SCALE FREE : 1 UNITS mm	DRAWING NO.	PART NO.				
	EDSC4-830174	DF30 Series				
	HRS HIROSE ELECTRIC CO.,LTD.	CODE NO.	CL684	2/3		



1	2				3				4	
COUNT	DESCRIPTION OF REVISIONS	BY	CHKD	DATE	COUNT	DESCRIPTION OF REVISIONS	BY	CHKD	DATE	
△					△				. .	
△					△				. .	
△					△				. .	

⚠ WHEN FPC IS SOFT, STRESS IS CONCENTRATED ON THE CONTACTS AT CORNERS. PLEASE PAY ATTENTION TO THIS POINT AND DO NOT UNMATE CONNECTORS FROM CORNERS AS FIGURE-10. THIS GIVES SERIOUS DAMAGE ON CONTACTS, AND OCCURS SOLDER PEEL-OFF OR CONTACT COME-OFF.

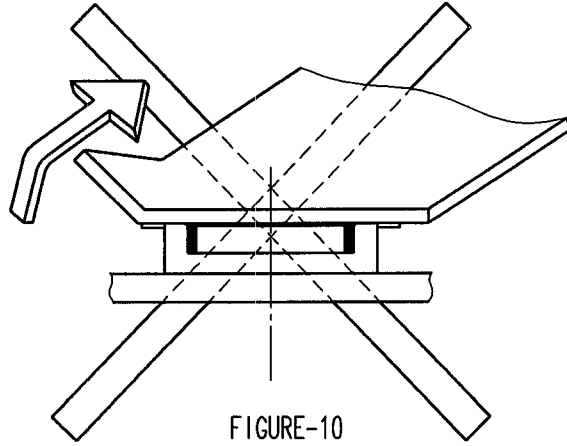

FIGURE-10

IF YOU MOUNT PLUG CONNECTOR ON FPC, CONTACTS MIGHT COME OFF FROM HOUSING MOLD.

CONTACT MIGHT COME OFF FROM HOUSING MOLD.

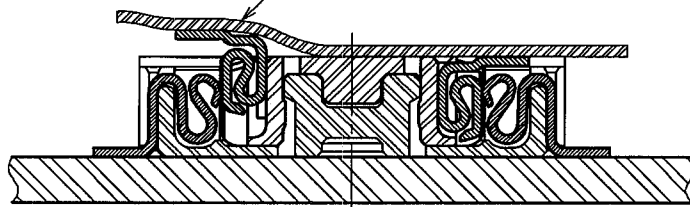

FIGURE-11

IN CASE YOU MOUNT RECEPTACLE CONNECTOR ON FPC, THERE IS NO RISK OF CONTACT COME-OFF. HIROSE RECOMMEND THAT RECEPTACLE IS MOUNTED ON FPC.

IN ORDER TO AVOID THIS RISK, IT IS RECOMMENDED THAT YOU MOUNT RECEPTACLE CONNECTOR ON FPC.

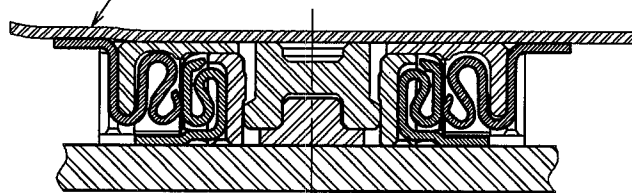

FIGURE-12

CODE NO. (OLD)		DRAWN	DESIGNED	CHECKED	APPROVED	RELEASED
NOTES WHEN EXTRACTING (SUPPLEMENTARY DATA)		Y.MICHIDA	A.TAKAHASHI	T.SAKATA	T.OMA	
		04.12.16	04.12.16	04.12.16	04.12.16	
F	SCALE FREE : 1 UNITS mm	DRAWING NO. EDSC4-830174		PART NO. DF30 Series		
		HIROSE ELECTRIC CO.,LTD.		CODE NO. CL684	3/3	

