

SFH 7051

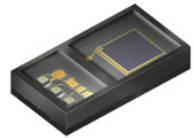

Features:

- Multi chip package featuring 3 green emitters and one detector
- Small package:(WxDxH) 4.7 mm x 2.5 mm x 0.9 mm
- Light Barrier to block optical crosstalk

Applications

- Heart rate monitoring

for:

- Wearable devices (e.g. smart watches, fitness trackers, ...)
- Mobile devices

Ordering Information SFH 7051

Type	Ordering Code
SFH 7051	Q65111A7792

Pin configuration

Pin	Name	Function
1	G1A	Green LED Anode
2	G1C	Green LED Cathode
3	G2C	Green LED Cathode
4	PA	Photodiode Anode
5	PC	Photodiode Cathode
6	G2A	Green LED Anode
7	G3C	Green LED Cathode
8	G3A	Green LED Anode

Top view

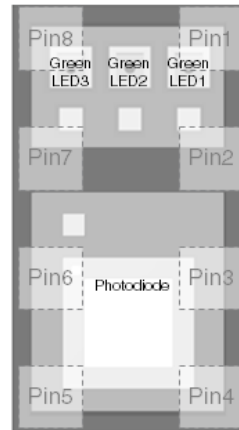

Block diagram

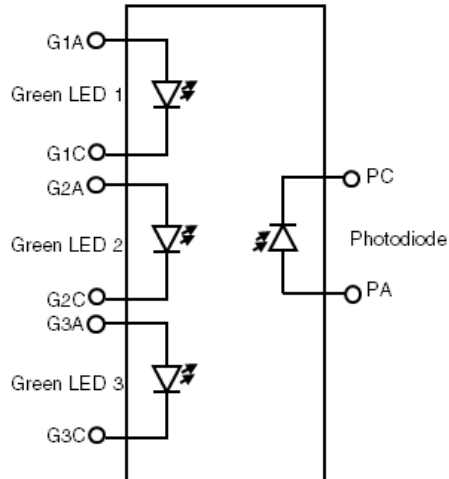

Maximum Ratings ($T_A = 25\text{ °C}$)

Parameter	Symbol	Values	Unit
General			
Operating temperature range	T_{op}	-40 ... 85	°C
Storage temperature range	T_{stg}	-40 ... 85	°C
ESD withstand voltage (acc. to ANSI/ ESDA/ JEDEC JS-001 - HBM)	V_{ESD}	2	kV
Green Emitters			
Reverse voltage	V_R	5	V
Forward current (single emitter operation)	$I_{F(DC)}$	25	mA
Forward current (all emitters active)	$I_{F(DC)}$	15	mA
Surge current ($t_p = 100\ \mu\text{s}$, $D = 0$)	I_{FSM}	300	mA
Detector			
Reverse voltage	V_R	16	V

Characteristics ($T_A = 25\text{ °C}$)

Parameter		Symbol	Value	Unit
Green Emitter (single emitter)				
Wavelength of peak emission ($I_F = 20\text{ mA}$)	(typ.)	λ_{peak}	530	nm
Centroid Wavelength ($I_F = 20\text{ mA}$)	(typ. (max.))	$\lambda_{\text{centroid}}$	535 (± 10)	nm
Spectral bandwidth at 50% of I_{max} ($I_F = 20\text{ mA}$)	(typ.)	$\Delta\lambda$	34	nm
Half angle	(typ.)	φ	± 60	$^\circ$
Rise and fall time of I_e (10% and 90% of $I_{e\text{max}}$) ($I_F = 100\text{ mA}$, $t_p = 16\text{ }\mu\text{s}$, $R_L = 50\text{ }\Omega$)	(typ.)	t_r , t_f	32	ns
Forward voltage ($I_F = 20\text{ mA}$)	(typ. (max.))	V_F	3.2 (≤ 3.7)	V
Reverse current ($V_R = 5\text{ V}$)		I_R	not designed for reverse operation	μA
Radiant intensity ($I_F = 20\text{ mA}$, $t_p = 20\text{ ms}$)	(typ.)	I_e	1.4	mW / sr
Total radiant flux ($I_F = 20\text{ mA}$, $t_p = 20\text{ ms}$)	(typ.)	Φ_e	3.4	mW
Temperature coefficient of $\lambda_{\text{centroid}}$ ($I_F = 20\text{ mA}$, $-10^\circ\text{C} \leq T \leq 100^\circ\text{C}$)	(typ.)	$TC_{\lambda_{\text{centroid}}}$	0.02	nm / K
Temperature coefficient of V_F ($I_F = 20\text{ mA}$, $-10^\circ\text{C} \leq T \leq 100^\circ\text{C}$)	(typ.)	TC_V	-4.0	mV / K

Characteristics ($T_A = 25\text{ °C}$)

Parameter		Symbol	Value	Unit
Detector				
Photocurrent ($E_e = 0.1\text{ mW/cm}^2$, $\lambda = 535\text{ nm}$, $V_R = 5\text{ V}$)	(typ.)	$I_{P,535}$	0.42	μA
Wavelength of max. sensitivity	(typ.)	$\lambda_{S\text{ max}}$	920	nm
Spectral range of sensitivity	(typ.)	$\lambda_{10\%}$	400 ... 1100	nm
Radiation sensitive area	(typ.)	A	1.7	mm^2
Dimensions of radiant sensitive area	(typ.)	L x W	1.3 x 1.3	mm x mm
Dark current ($V_R = 5\text{ V}$, $E_e = 0\text{ mW/cm}^2$)	(typ. (max.))	I_R	1 (≤ 5)	nA
Spectral sensitivity of the chip ($\lambda = 535\text{ nm}$)	(typ.)	$S_{\lambda,535}$	0.27	A / W
Open-circuit voltage ($E_e = 0.1\text{ mW/cm}^2$, $\lambda = 535\text{ nm}$)	(typ.)	$V_{O,535}$	240	mV
Short-circuit current ($E_e = 0.1\text{ mW/cm}^2$, $\lambda = 535\text{ nm}$)	(typ.)	$I_{SC,535}$	0.40	μA
Rise and fall time ($V_R = 3.3\text{ V}$, $R_L = 50\ \Omega$, $\lambda = 535\text{ nm}$)	(typ.)	t_r , t_f	42	ns
Forward voltage ($I_F = 10\text{ mA}$, $E = 0\text{ mW/cm}^2$)	(typ.)	V_F	0.9	V
Capacitance ($V_R = 5\text{ V}$, $f = 1\text{ MHz}$, $E = 0\text{ mW/cm}^2$)	(typ.)	C_0	5	pF

Diagrams for green emitters

Relative spectral emission ¹⁾

$I_{rel} = f(\lambda), T_A = 25^\circ\text{C}, I_F = 20\text{ mA}$

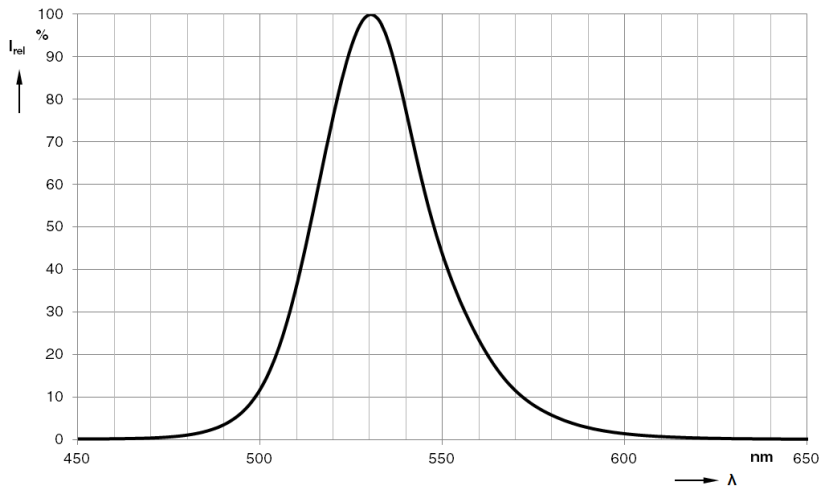

Forward current ¹⁾

$I_F = f(V_F), T_A = 25^\circ\text{C}$

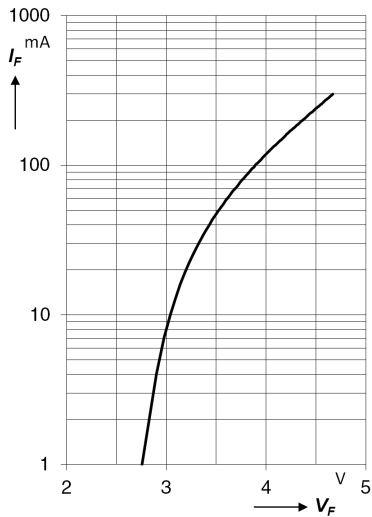

Relative radiant flux ¹⁾

$\Phi_e / \Phi_e(20\text{ mA}) = f(I_F), \text{ single pulse, } t_0 = 25\mu\text{s}, T_A = 25^\circ\text{C}$

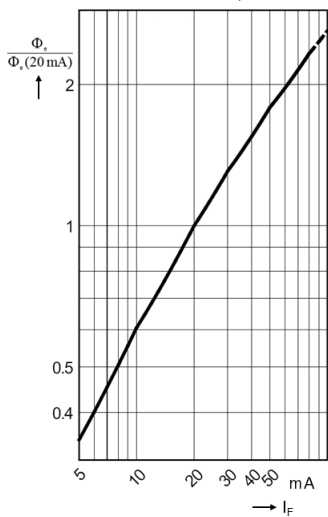

Diagrams for green emitters

Max. permissible forward current ¹⁾

(single emitter) $I_{F,max} = f(T_A), R_{thJA} = 800 \text{ K/W}$

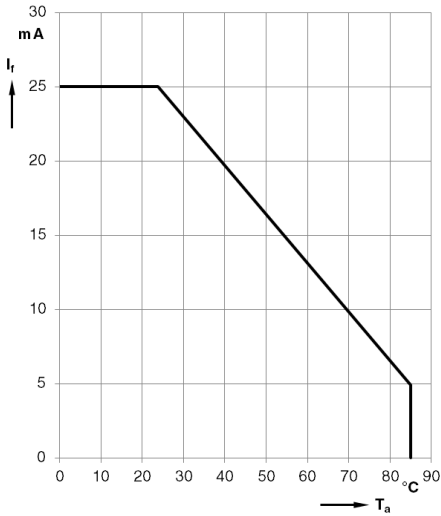

Permissible pulse handling capability ¹⁾

(single emitter) $I_F = f(t_p), T_A = 40^\circ\text{C}$, duty cycle D

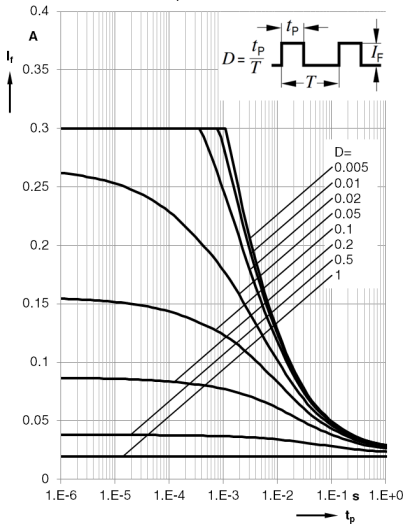

Permissible pulse handling capability ¹⁾

(single emitter) $I_F = f(t_p), T_A = 85^\circ\text{C}$, duty cycle D

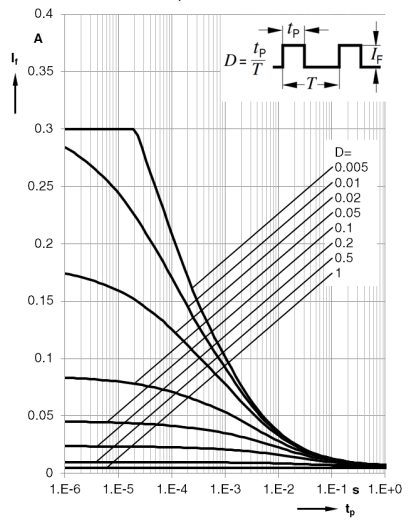

Diagrams for green emitters

Max. permissible forward current ¹⁾

(three emitters) $I_{F,max} = f(T_A), R_{thJA} = 800 \text{ K/W}$

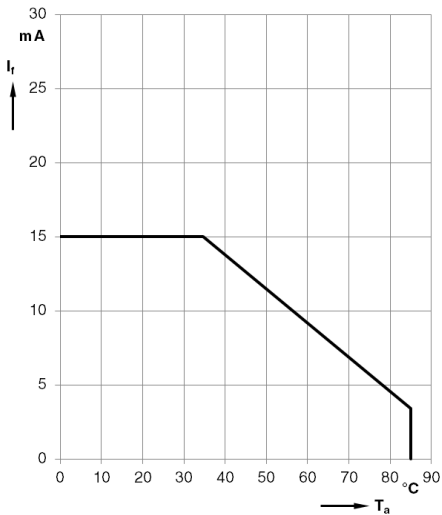

Permissible pulse handling capability ¹⁾

(three emitters) $I_F = f(t_p), T_A = 40^\circ\text{C}$, duty cycle D

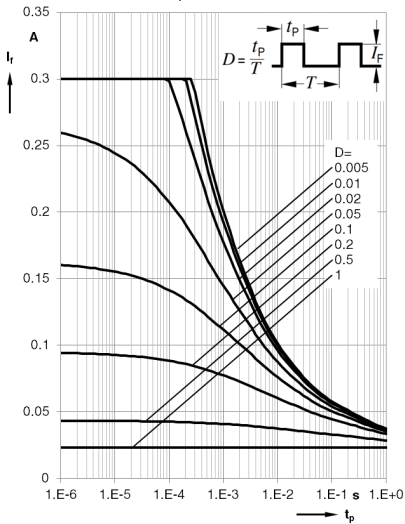

Permissible pulse handling capability ¹⁾

(three emitters) $I_F = f(t_p), T_A = 85^\circ\text{C}$, duty cycle D

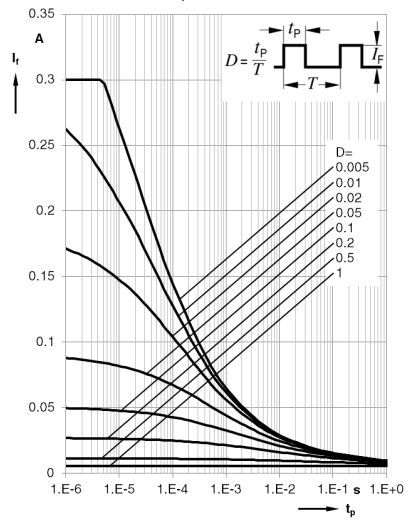

Diagrams for detector

Relative spectral sensitivity ¹⁾

$$S_{\text{rel}} = f(\lambda), T_A = 25 \text{ }^\circ\text{C}$$

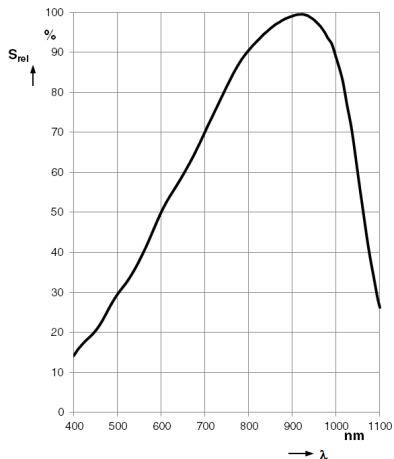
Photocurrent ¹⁾

$$I_P(V_R = 5 \text{ V}), \lambda = 530 \text{ nm}, T_A = 25 \text{ }^\circ\text{C}$$

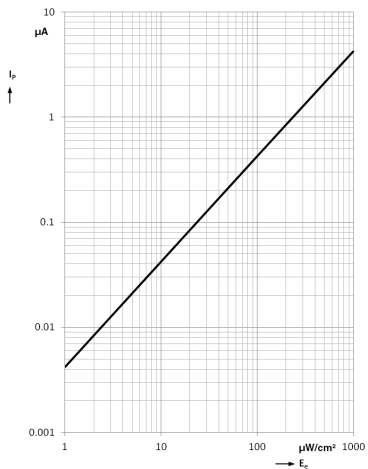
Dark current ¹⁾

$$I_R = f(V_R), E = 0 \text{ mW}/\text{cm}^2, T_A = 25 \text{ }^\circ\text{C}$$

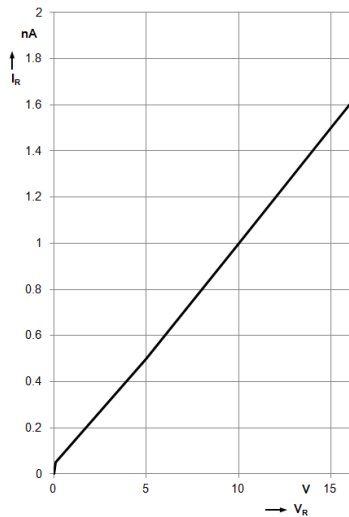
Capacitance ¹⁾

$$C = f(V_R), f = 1 \text{ MHz}, E = 0 \text{ mW}/\text{cm}^2, T_A = 25 \text{ }^\circ\text{C}$$

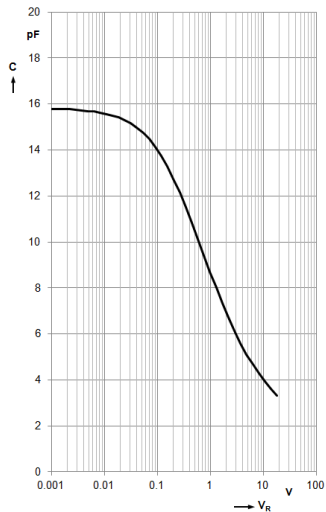

Directional characteristics of detector ¹⁾

$S_{rel} = f(\varphi)$

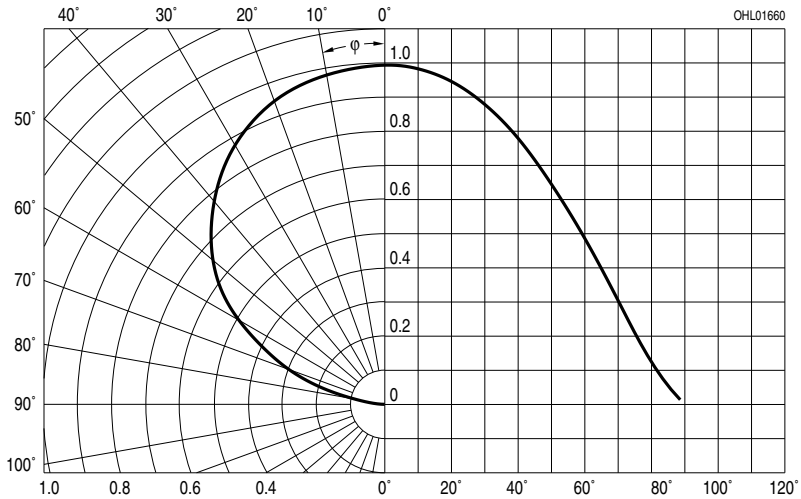

Radiation characteristics of emitter ¹⁾

$I_{rel} = f(\varphi)$

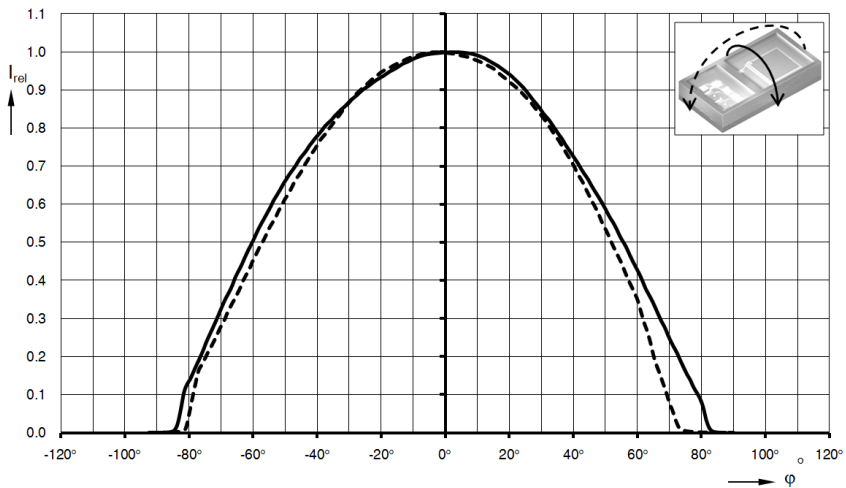

Package Outline

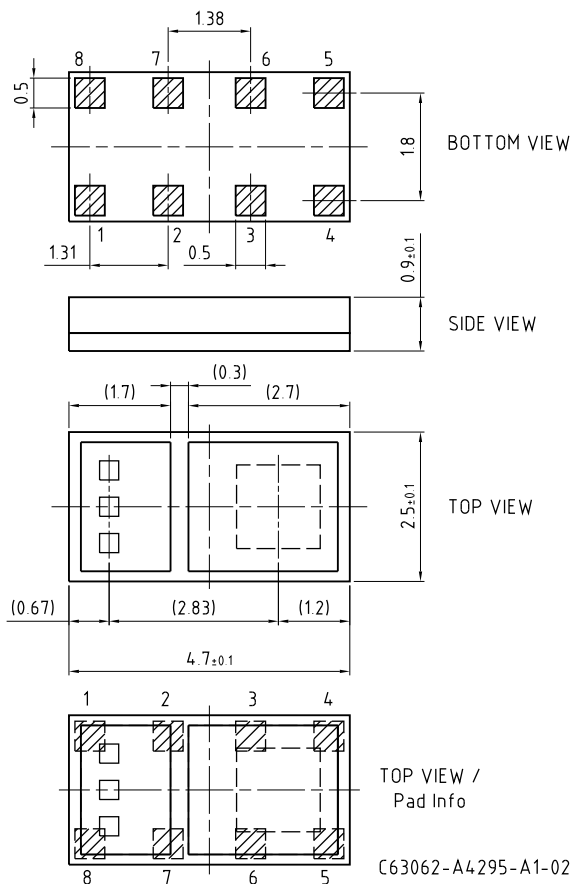

Pin1	Green LED 1 anode
Pin2	Green LED 1 cathode
Pin3	Green LED 2 cathode
Pin4	PD anode
Pin5	PD cathode
Pin6	Green LED 2 anode
Pin7	Green LED 3 cathode
Pin8	Green LED 3 anode

Dimensions in mm.

Package:
chip on board

Approximate Weight:
18 mg

Recommended solder pad design

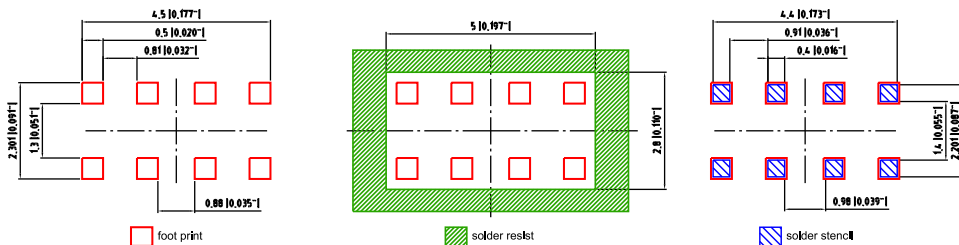

Component Location on Pad

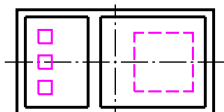

Dimensions in mm (inch).

E062 3010 172-01

Reflow Soldering Profile

Product complies to MSL Level 4 acc. to JEDEC J-STD-020D.01

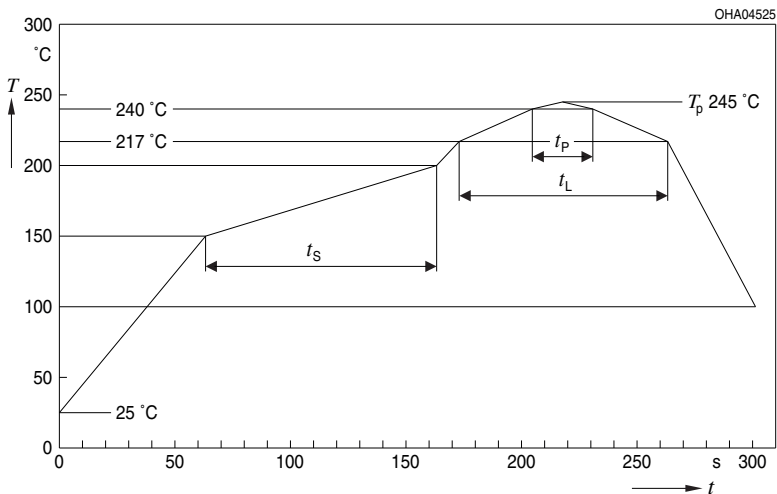

OHA04612

Profile Feature Profil-Charakteristik	Symbol Symbol	Pb-Free (SnAgCu) Assembly			Unit Einheit
		Minimum	Recommendation	Maximum	
Ramp-up rate to preheat*) 25 °C to 150 °C			2	3	K/s
Time t_s T_{Smin} to T_{Smax}	t_s	60	100	120	s
Ramp-up rate to peak*) T_{Smax} to T_p			2	3	K/s
Liquidus temperature	T_L	217			°C
Time above liquidus temperature	t_L		80	100	s
Peak temperature	T_p		245	260	°C
Time within 5 °C of the specified peak temperature T_p - 5 K	t_p	10	20	30	s
Ramp-down rate* T_p to 100 °C			3	6	K/s
Time 25 °C to T_p				480	s

All temperatures refer to the center of the package, measured on the top of the component

* slope calculation DT/Dt : Dt max. 5 s; fulfillment for the whole T-range

Method of Taping

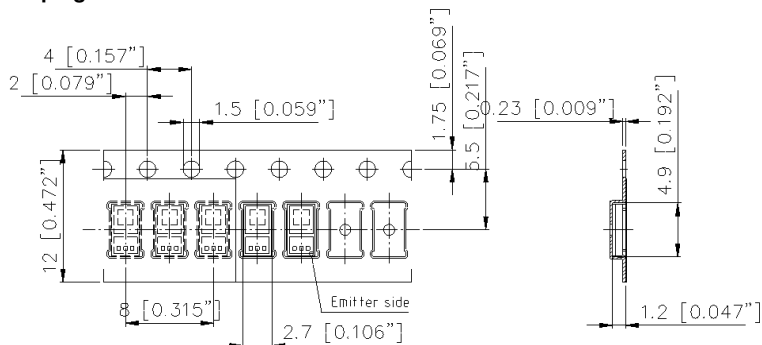

Dimensions in mm [inch].

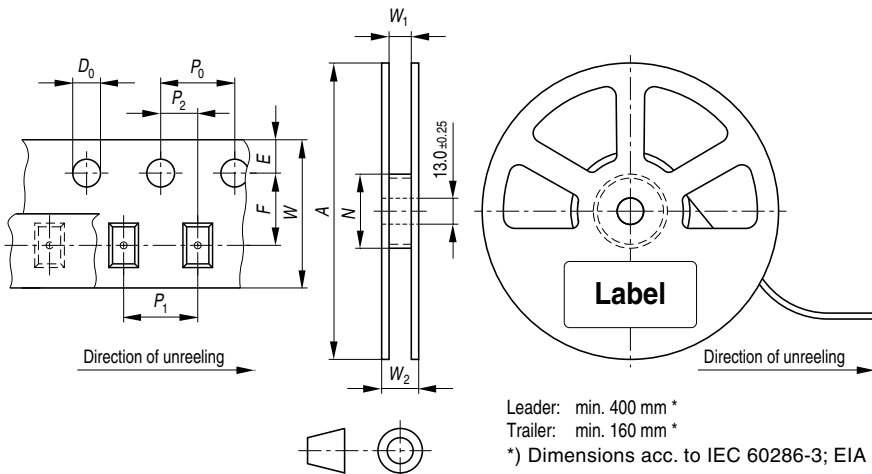
Tape and Reel12 mm tape with 3000 pcs. on \varnothing 180 mm reel

Dimensions in mm

Tape Dimensions [mm]

W	P ₀	P ₁	P ₂	D ₀	E	F
12 +0.3 / -0.1	4 ±0.1	4 ±0.1	2 ±0.05	1.5 ±0.1	1.75 ±0.1	5.5 ±0.05

Reel Dimensions [mm]

A	W	N _{min}	W ₁	W _{2max}
180	12	60	12.4 +2	18.4

Barcode-Product-Label (BPL)

OSRAM Opto Semiconductors LX XXXX BIN1: XX-XX-X-XXX-X

RoHS Compliant

(6P) BATCH NO: 1234567890

(1T) LOT NO: 1234567890 (9D) D/C: 1234

(X) PROD NO: 123456789 (Q) QTY: 9999 (G) GROUP: XX-XX-X-X

ML Temp ST
X XXX °C X

Pack: RXX
DEMY XXX
X_X123_1234.1234 X



The diagram shows a rectangular label with three main sections. The top section contains the OSRAM logo and product identification codes. The middle section features a large barcode, a smaller barcode, and a QR code. The bottom section contains another large barcode. A circular icon with a crossed-out rain cloud is positioned between the middle and bottom sections.

OHA04563

Dry Packing Process and Materials

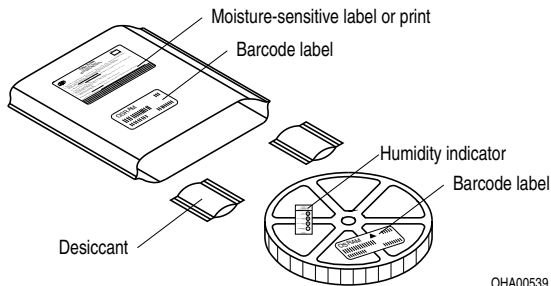

OHA00539

Note:

Moisture-sensitive product is packed in a dry bag containing desiccant and a humidity card. Regarding dry pack you will find further information in the internet. Here you will also find the normative references like JEDEC.

Transportation Packing and Materials

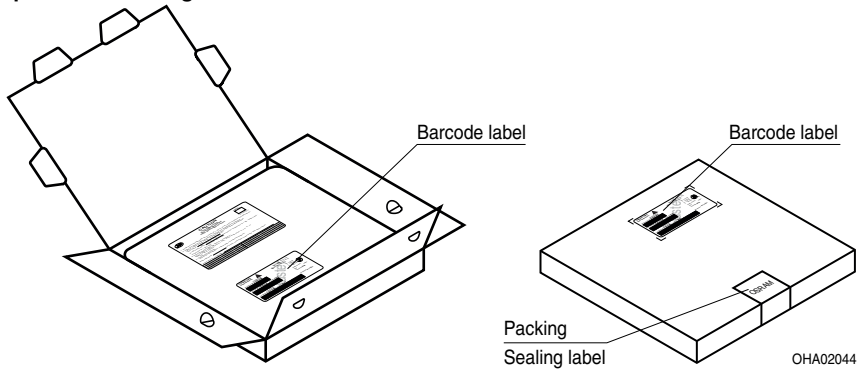

Dimensions of transportation box in mm

Width	Length	Height
195 ± 5	195 ± 5	42 ± 5

Disclaimer

Language english will prevail in case of any discrepancies or deviations between the two language wordings.

Attention please!

The information describes the type of component and shall not be considered as assured characteristics.

Terms of delivery and rights to change design reserved. Due to technical requirements components may contain dangerous substances.

For information on the types in question please contact our Sales Organization. If printed or downloaded, please find the latest version in the Internet.

Packing

Please use the recycling operators known to you. We can also help you – get in touch with your nearest sales office. By agreement we will take packing material back, if it is sorted. You must bear the costs of transport. For packing material that is returned to us unsorted or which we are not obliged to accept, we shall have to invoice you for any costs incurred.

Components used in life-support devices or systems must be expressly authorized for such purpose!

Critical components* may only be used in life-support devices** or systems with the express written approval of OSRAM OS.

*) A critical component is a component used in a life-support device or system whose failure can reasonably be expected to cause the failure of that life-support device or system, or to affect its safety or the effectiveness of that device or system.

**) Life support devices or systems are intended (a) to be implanted in the human body, or (b) to support and/or maintain and sustain human life. If they fail, it is reasonable to assume that the health and the life of the user may be endangered.

Glossary

¹⁾ **Typical Values:** Due to the special conditions of the manufacturing processes of LED and photodiodes, the typical data or calculated correlations of technical parameters can only reflect statistical figures. These do not necessarily correspond to the actual parameters of each single product, which could differ from the typical data and calculated correlations or the typical characteristic line. If requested, e.g. because of technical improvements, these typ. data will be changed without any further notice.

Published by OSRAM Opto Semiconductors GmbH
Leibnizstraße 4, D-93055 Regensburg
www.osram-os.com © All Rights Reserved.

EU RoHS and China RoHS compliant product



此产品符合欧盟 RoHS 指令的要求；

按照中国的相关法规和标准，不含有毒有害物质或元素。