

## Description

The 74AUP1G98 is a single, 3-input positive configurable multiple function gate with a standard push-pull output. The output state is determined by eight patterns of 3-bit input. The user can choose the logic functions MUX, AND, OR, NAND, NOR, inverter or non-inverting buffer. All inputs can be connected to ground or Vcc as required.

The device is designed for operation with a power supply range of 0.8V to 3.6V.

The inputs are tolerant to 3.6V allowing this device to be used in a mixed voltage environment.

The device is fully specified for partial power down applications using IOFF. The IOFF circuitry disables the output preventing damaging current backflow when the device is powered down. The user is reminded that the device can simulate several types of logic gates but may respond differently due to the Schmitt action at the inputs.

## Features

- Advanced Ultra Low-Power (AUP) CMOS
- Supply Voltage Range from 0.8V to 3.6V
- $\pm 4\text{mA}$  Output Drive at 3.0V
- Low Static Power Consumption
- $I_C < 0.9\mu\text{A}$
- Low Dynamic Power Consumption
- $C_{PD} = 4.8\text{pF}$  Typical at 3.6V
- Schmitt Trigger Action at All Inputs Make the Circuit Tolerant for Slower Input Rise and Fall Time. The hysteresis is typically 950mV at  $V_{CC} = 3.0\text{V}$
- IOFF Supports Partial-Power-Down Mode Operation
- ESD Protection per JESD 22
  - Exceeds 200-V Machine Model (A115)
  - Exceeds 2000-V Human Body Model (A114)
  - Exceeds 1000-V Charged Device Model (C101)
- Latch-Up Exceeds 100mA per JESD 78, Class I
- Standard SOT26 and SOT363 Packages
- Leadless Packages per JESD30E
  - DFN1410 denoted as X2-DFN1410-6
  - DFN1010 denoted as X2-DFN1010-6
  - DFN0910 denoted as X2-DFN0910-6
- **Totally Lead-Free & Fully RoHS Compliant (Notes 1 & 2)**
- **Halogen and Antimony Free. "Green" Device (Note 3)**

Notes:

1. No purposely added lead. Fully EU Directive 2002/95/EC (RoHS) & 2011/65/EU (RoHS 2) compliant.
2. See [http://www.diodes.com/quality/lead\\_free.html](http://www.diodes.com/quality/lead_free.html) for more information about Diodes Incorporated's definitions of Halogen- and Antimony-free, "Green" and Lead-free.
3. Halogen- and Antimony-free "Green" products are defined as those which contain <900ppm bromine, <900ppm chlorine (<1500ppm total Br + Cl) and <1000ppm antimony compounds.

## Pin Assignments

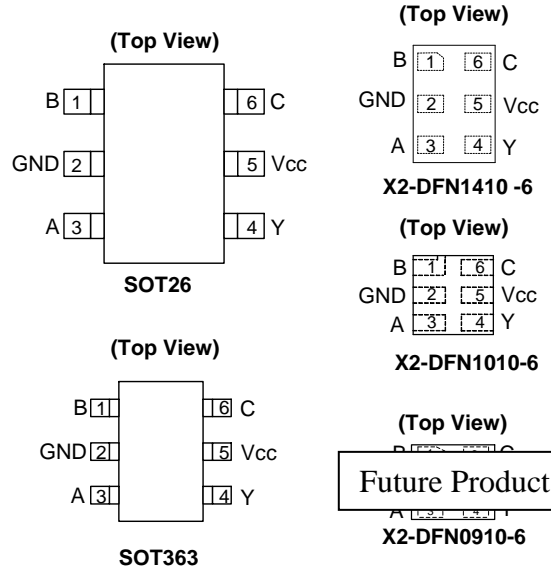

## Applications

- Suited for Battery and Low Power Needs
- Voltage Level Shifting
- General Purpose Logic
- Power Down Signal Isolation
- Wide Array of Products such as:
  - PCs, Networking, Notebooks, Netbooks, PDAs
  - Tablet Computers, E-readers
  - Computer Peripherals, Hard Drives, CD/DVD ROMs
  - TVs, DVDs, DVRs, Set-Top Boxes
  - Cell Phones, Personal Navigation / GPS
  - MP3 Players, Cameras, Video Recorders

## Ordering Information

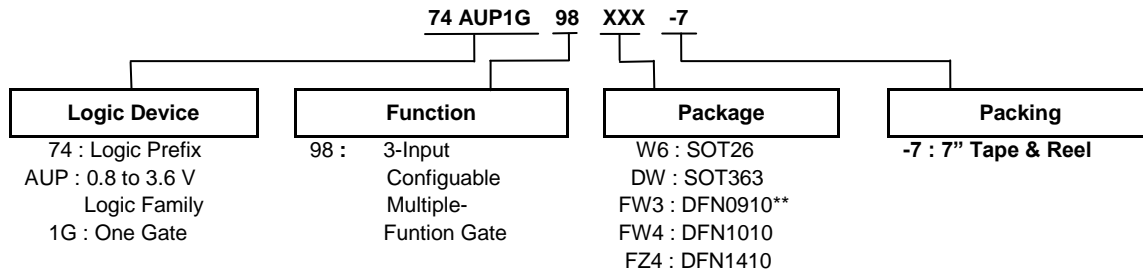

Device	Package Code	Package (Notes 4 & 5)	Package Size	7" Tape and Reel	
				Quantity	Part Number Suffix
74AUP1G98W6-7	W6	SOT26	3.0mm x 2.8mm x 1.2mm 0.95 mm lead pitch	3,000/Tape & Reel	-7
74AUP1G98DW-7	DW	SOT363	2.0mm x 2.0mm x 1.1mm 0.65 mm lead pitch	3,000/Tape & Reel	-7
74AUP1G98FW3-7 **	FW3	X2-DFN0910-6	0.9mm x 1.0mm x 0.35mm 0.3 mm lead pitch	5,000/Tape & Reel	-7
74AUP1G98FW4-7	FW4	X2-DFN1010-6	1.0mm x 1.0mm x 0.4mm 0.35 mm lead pitch	5,000/Tape & Reel	-7
74AUP1G98FZ4-7	FZ4	X2-DFN1410-6	1.4mm x 1.0mm x 0.4mm 0.5 mm lead pitch	5,000/Tape & Reel	-7

- Notes:
4. Pad layout as shown on Diodes Inc. suggested pad layout document AP02001, which can be found on our website at <http://www.diodes.com/datasheets/ap02001.pdf>.
  5. The taping orientation is located on our website at <http://www.diodes.com/datasheets/ap02007.pdf>.
- \*\* The X2-DFN0910-6 is a future product.

## Pin Descriptions

Pin Name	Function
B	Data Input
GND	Ground
A	Data Input
Y	Data Output
V <sub>CC</sub>	Supply Voltage
C	Data Input

## Function Table

Inputs			Output
C	B	A	Y
L	L	L	H
L	L	H	H
L	H	L	L
L	H	H	L
H	L	L	H
H	L	H	L
H	H	L	H
H	H	H	L

**Logic Diagram**

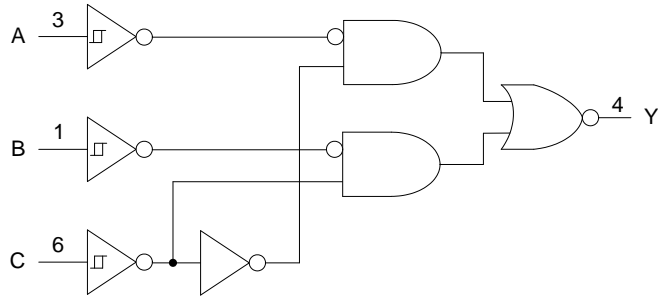

NEW PRODUCT

**Logic Configurations**

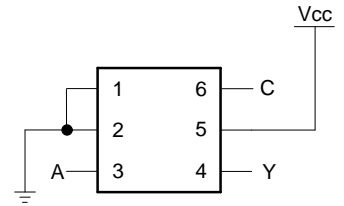
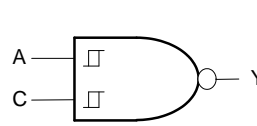
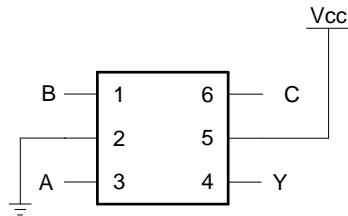
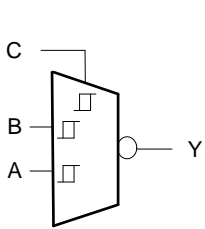

**Configuration 1**  
2 to 1 Data Selector  
When C is = L,  $Y = \bar{B}$ ; When C is H,  $Y = \bar{A}$

**Configuration 2**  
2-Input NAND Gate  
2-Input OR Gate with Both Inputs Inverted

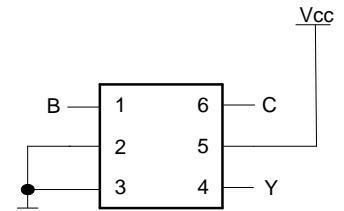
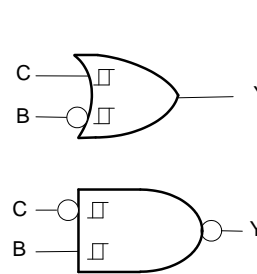
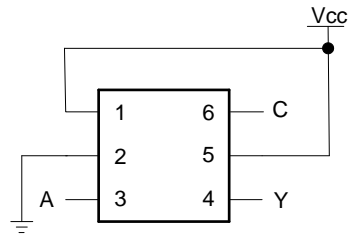
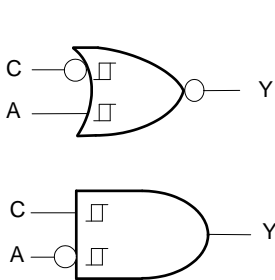

**Configuration 3**  
2-Input NAND Gate with B Input Inverted  
2-Input OR Gate with A Input Inverted

**Configuration 4**  
2-Input OR Gate with One Input Inverted  
2-Input NAND Gate with One Input Inverted

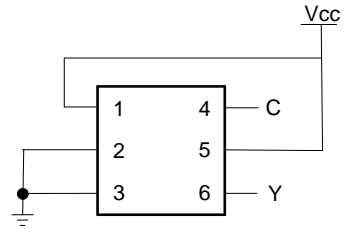
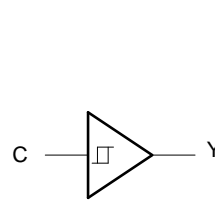
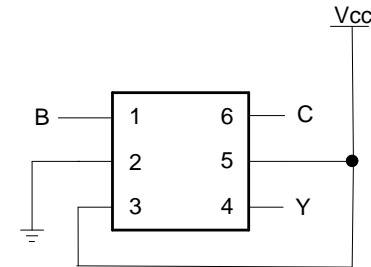
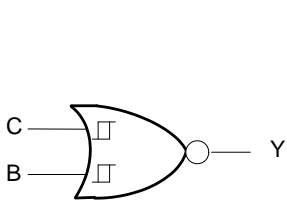

**Configuration 5**  
2-Input NOR Gate

**Configuration 6**  
Buffer

Function Selection Table	
Logic Function	Configuration
2-to-1 Data Selector with inverted output	1
2-Input NAND gate	2
2-Input AND with inverted input	3
2-Input NOR with inverted input	3
2-Input NAND with one inverted input	4
2-Input OR with one inverted input	4
2-Input NOR	5
1-Input Buffer	6

NEW PRODUCT

**Absolute Maximum Ratings** (Notes 6 & 7)

Symbol	Description	Rating	Unit
ESD HBM	Human Body Model ESD Protection	2	kV
ESD CDM	Charged Device Model ESD Protection	1	kV
ESD MM	Machine Model ESD Protection	200	V
V <sub>CC</sub>	Supply Voltage Range	-0.5 to +4.6	V
V <sub>I</sub>	Input Voltage Range	-0.5 to +4.6	V
V <sub>O</sub>	Voltage applied to output in high or low state	-0.5 to V <sub>CC</sub> +0.5	V
I <sub>IK</sub>	Input Clamp Current V <sub>I</sub> <0	-50	mA
I <sub>OK</sub>	Output Clamp Current (V <sub>O</sub> < 0)	-50	mA
I <sub>O</sub>	Continuous Output Current (V <sub>O</sub> = 0 to V <sub>CC</sub> )	±20	mA
I <sub>CC</sub>	Continuous Current through V <sub>CC</sub>	50	mA
I <sub>GND</sub>	Continuous Current through GND	-50	mA
T <sub>J</sub>	Operating Junction Temperature	-40 to +150	°C
T <sub>STG</sub>	Storage Temperature	-65 to +150	°C

- Notes:
- Stresses beyond the absolute maximum may result in immediate failure or reduced reliability. These are stress values and device operation should be within recommend values.
  - Forcing the maximum allowed voltage could cause a condition exceeding the maximum current or conversely forcing the maximum current could cause a condition exceeding the maximum voltage. The ratings of both current and voltage must be maintained within the controlled range.

**Recommended Operating Conditions** (Note 8)

Symbol	Parameter		Min	Max	Unit
V <sub>CC</sub>	Operating Voltage	-	0.8	3.6	V
V <sub>I</sub>	Input Voltage	-	0	3.6	V
V <sub>O</sub>	Output Voltage	Active Mode	0	V <sub>CC</sub>	V
		Power Down Mode	0	3.6	V
I <sub>OH</sub>	High-Level Output Current	V <sub>CC</sub> = 0.8 V	-	-20	μA
		V <sub>CC</sub> = 1.1 V	-	-1.1	mA
		V <sub>CC</sub> = 1.4 V	-	-1.7	
		V <sub>CC</sub> = 1.65 V	-	-1.9	
		V <sub>CC</sub> = 2.3 V	-	-3.1	
		V <sub>CC</sub> = 3.0 V	-	-4	
I <sub>OL</sub>	Low-Level Output Current	V <sub>CC</sub> = 0.8 V	-	20	μA
		V <sub>CC</sub> = 1.1 V	-	1.1	mA
		V <sub>CC</sub> = 1.4 V	-	1.7	
		V <sub>CC</sub> = 1.65 V	-	1.9	
		V <sub>CC</sub> = 2.3 V	-	3.1	
		V <sub>CC</sub> = 3.0 V	-	4	
T <sub>A</sub>	Operating Free-Air Temperature	-	-40	+125	°C

Note: 8. Unused inputs should be held at V<sub>CC</sub> or Ground.

**Electrical Characteristics**

Symbol	Parameter	Test Conditions	Vcc	T <sub>A</sub> = +25°C		T <sub>A</sub> = -40 to +85°C		Unit
				Min	Max	Min	Max	
V <sub>T+</sub>	Positive-Going Input Threshold Voltage	-	0.8V	0.3	0.65	0.3	0.7	V
		-	1.1V	0.53	0.9	0.53	0.9	
		-	1.4V	0.74	1.11	0.74	1.11	
		-	1.65V	0.91	1.29	0.91	1.29	
		-	2.3V	1.37	1.77	1.37	1.77	
V <sub>T-</sub>	Negative-Going Input Threshold Voltage	-	0.8V	0.1	0.6	0.1	0.6	V
		-	1.1V	0.26	0.65	0.26	0.65	
		-	1.4V	0.39	0.75	0.39	0.75	
		-	1.65V	0.47	0.84	0.47	0.84	
		-	2.3V	0.69	1.04	0.69	1.04	
ΔV <sub>T</sub>	Hysteresis (V <sub>T+</sub> - V <sub>T-</sub> )	-	0.8V	0.07	0.5	0.07	0.5	V
		-	1.1V	0.08	0.46	0.08	0.46	
		-	1.4V	0.18	0.56	0.18	0.56	
		-	1.65V	0.27	0.66	0.27	0.66	
		-	2.3V	0.53	0.92	0.53	0.92	
V <sub>OH</sub>	High-Level Output Voltage	I <sub>OH</sub> = -20μA	0.8V to 3.6V	V <sub>CC</sub> - 0.1	-	V <sub>CC</sub> - 0.1	-	V
		I <sub>OH</sub> = -1.1mA	1.1V	0.75 x V <sub>CC</sub>	-	0.7 x V <sub>CC</sub>	-	
		I <sub>OH</sub> = -1.7mA	1.4V	1.11	-	1.03	-	
		I <sub>OH</sub> = -1.9mA	1.65V	1.32	-	1.3	-	
		I <sub>OH</sub> = -2.3mA	2.3V	2.05	-	1.97	-	
		I <sub>OH</sub> = -3.1mA		1.9	-	1.85	-	
		I <sub>OH</sub> = -2.7mA	3V	2.72	-	2.67	-	
		I <sub>OH</sub> = -4mA		2.6	-	2.55	-	
V <sub>OL</sub>	Low-Level Input Voltage	I <sub>OL</sub> = 20μA	0.8V to 3.6V	-	0.1	-	0.1	V
		I <sub>OL</sub> = 1.1mA	1.1V	-	0.3 x V <sub>CC</sub>	-	0.3 x V <sub>CC</sub>	
		I <sub>OL</sub> = 1.7mA	1.4V	-	0.31	-	0.37	
		I <sub>OL</sub> = 1.9mA	1.65 V	-	0.31	-	0.35	
		I <sub>OL</sub> = 2.3mA	2.3V	-	0.31	-	0.33	
		I <sub>OL</sub> = 3.1mA		-	0.44	-	0.45	
		I <sub>OL</sub> = 2.7mA	3V	-	0.31	-	0.33	
I <sub>OL</sub> = 4mA	-	0.44		-	0.45			
I <sub>I</sub>	Input Current	A or B Input V <sub>I</sub> = GND to 3.6 V	0V to 3.6V	-	± 0.1	-	± 0.5	μA
I <sub>OFF</sub>	Power Down Leakage Current	V <sub>I</sub> or V <sub>O</sub> = 0V to 3.6V	0	-	± 0.2	-	± 0.6	μA
ΔI <sub>OFF</sub>	Delta Power Down Leakage Current	V <sub>I</sub> or V <sub>O</sub> = 0V to 3.6V	0V to 0.2 V	-	± 0.2	-	± 0.6	μA
I <sub>CC</sub>	Supply Current	V <sub>I</sub> = GND or V <sub>CC</sub> I <sub>O</sub> = 0	0.8V to 3.6V	-	0.5	-	0.9	μA
ΔI <sub>CC</sub>	Additional Supply Current	One input at V <sub>CC</sub> - 0.6 V Other inputs at V <sub>CC</sub> or GND	3.3V	-	40	-	50	μA

**Electrical Characteristics** (continued)

Symbol	Parameter	Test Conditions	Vcc	T <sub>A</sub> = -40 to +125°C		Unit
				Min	Max	
V <sub>T+</sub>	Positive-Going Input Threshold Voltage	-	0.8V	0.3	0.7	V
		-	1.1V	0.53	0.92	
		-	1.4V	0.74	1.13	
		-	1.65V	0.91	1.31	
		-	2.3V	1.37	1.8	
V <sub>T-</sub>	Negative-Going Input Threshold Voltage	-	0.8V	0.1	0.6	V
		-	1.1V	0.26	0.65	
		-	1.4V	0.39	0.75	
		-	1.65V	0.47	0.84	
		-	2.3V	0.69	1.04	
ΔV <sub>T</sub>	Hysteresis (V <sub>T+</sub> - V <sub>T-</sub> )	-	0.8V	0.07	0.5	V
		-	1.1V	0.08	0.46	
		-	1.4V	0.18	0.56	
		-	1.65V	0.27	0.66	
		-	2.3V	0.53	0.92	
V <sub>OH</sub>	High-Level Output Voltage	I <sub>OH</sub> = -20μA	0.8V to 3.6V	V <sub>CC</sub> - 0.11	-	V
		I <sub>OH</sub> = -1.1mA	1.1V	0.6 x V <sub>CC</sub>	-	
		I <sub>OH</sub> = -1.7mA	1.4V	0.93	-	
		I <sub>OH</sub> = -1.9mA	1.65V	1.17	-	
		I <sub>OH</sub> = -2.3mA	2.3V	1.77	-	
		I <sub>OH</sub> = -3.1mA		1.67	-	
		I <sub>OH</sub> = -2.7mA	3V	2.40	-	
		I <sub>OH</sub> = -4mA		2.30	-	
V <sub>OL</sub>	Low-Level Input Voltage	I <sub>OL</sub> = 20μA	0.8V to 3.6V	-	0.11	V
		I <sub>OL</sub> = 1.1mA	1.1V	-	0.33 x V <sub>CC</sub>	
		I <sub>OL</sub> = 1.7mA	1.4V	-	0.41	
		I <sub>OL</sub> = 1.9mA	1.65 V	-	0.39	
		I <sub>OL</sub> = 2.3mA	2.3V	-	0.36	
		I <sub>OL</sub> = 3.1mA		-	0.50	
		I <sub>OL</sub> = 2.7mA	3V	-	0.36	
		I <sub>OL</sub> = 4mA		-	0.50	
I <sub>I</sub>	Input Current	A or B Input V <sub>I</sub> = GND to 3.6 V	0V to 3.6V	-	± 0.75	μA
I <sub>OFF</sub>	Power Down Leakage Current	V <sub>I</sub> or V <sub>O</sub> = 0V to 3.6V	0	-	± 1.0	μA
ΔI <sub>OFF</sub>	Delta Power Down Leakage Current	V <sub>I</sub> or V <sub>O</sub> = 0V to 3.6V	0V to 0.2 V	-	± 2.5	μA
I <sub>CC</sub>	Supply Current	V <sub>I</sub> = GND or V <sub>CC</sub> I <sub>O</sub> = 0	0.8V to 3.6V	-	1.4	μA
ΔI <sub>CC</sub>	Additional Supply Current	One input at V <sub>CC</sub> - 0.6 V Other inputs at V <sub>CC</sub> or GND	3.3V	-	75	μA

**NEW PRODUCT**

### Package Characteristics

Symbol	Parameter	Package	Test Conditions	Min	Typ.	Max	Unit
$\theta_{JA}$	Thermal Resistance Junction-to-Ambient	SOT26	(Note 9)	-	166	-	°C/W
		SOT363		-	371	-	
		X2-DFN0910-6		-	450	-	
		X2-DFN1010-6		-	445	-	
		X2-DFN1410-6		-	430	-	
$\theta_{JC}$	Thermal Resistance Junction-to-Case	SOT26	(Note 9)	-	46	-	°C/W
		SOT363		-	143	-	
		X2-DFN0910-6		-	255	-	
		X2-DFN1010-6		-	250	-	
		X2-DFN1410-6		-	190	-	

Note: 9. Test condition for each of the 8 package types: Device mounted on FR-4 substrate PC board, 2oz copper, with minimum recommended pad layout.

### Operating Characteristics (@ $T_A = +25^\circ\text{C}$ , unless otherwise specified.)

Parameter		Test Conditions	Vcc	TYP	Unit
$C_{pd}$	Power Dissipation Capacitance	f = 1MHz No Load	0.8 V	4	pF
			1.2V ± 0.1V	4	
			1.5V ± 0.1V	4	
			1.8V ± 0.15V	4	
			2.5V ± 0.2V	4.4	
			3.3 ± 0.3V	4.8	
$C_i$	Input Capacitance	$V_i = V_{CC}$ or GND	0 V or 3.3V	1.1	pF
$C_o$	Output Capacitance	$V_0 = V_{CC}$ or GND	0 V	2.0	pF

### Switching Characteristics

$C_L = 5\text{pF}$ , See Figure 1

Parameter	From Input	TO OUTPUT	Vcc	$T_A = +25^\circ\text{C}$			$T_A = -40^\circ\text{C to } +85^\circ\text{C}$		$T_A = -40^\circ\text{C to } +125^\circ\text{C}$		Unit
				Min	TYP	Max	Min	Max	Min	Max	
$t_{pd}$	A, B, or C	Y	0.8 V	-	28.0	-	-	-	-	-	ns
			1.2 V ± 0.1 V	2.7	6.7	14.6	2.2	15	2.2	15.3	
			1.5 V ± 0.1 V	2	4.8	7.7	1.5	8.3	1.5	8.7	
			1.8 V ± 0.15 V	1.4	4	6.3	0.9	7	0.9	7.4	
			2.5 V ± 0.2 V	1.2	3.2	4.6	0.7	5.2	0.7	5.4	
			3.3 V ± 0.3 V	1	2.9	4	0.5	4.2	0.5	4.4	



**Switching Characteristics** (continued)

 $C_L=10\text{pF}$ , See Figure 1

Parameter	From Input	TO OUTPUT	$V_{CC}$	$T_A = +25^\circ\text{C}$			$T_A = -40^\circ\text{C to } +85^\circ\text{C}$		$T_A = -40^\circ\text{C to } +125^\circ\text{C}$		Unit
				Min	TYP	Max	Min	Max	Min	Max	
$t_{pd}$	A, B, or C	Y	0.8 V	-	32	-	-	-	-	-	ns
			$1.2\text{ V} \pm 0.1\text{ V}$	3.3	7.6	16.5	3	17.2	3	17.5	
			$1.5\text{ V} \pm 0.1\text{ V}$	2.7	5.4	8.8	2.8	9.5	2.8	9.9	
			$1.8\text{ V} \pm 0.15\text{ V}$	2.5	4.6	7.2	2.3	8	2.3	8.4	
			$2.5\text{ V} \pm 0.2\text{ V}$	2.4	3.8	5.3	2.2	5.9	2.2	6.2	
			$3.3\text{ V} \pm 0.3\text{ V}$	2.3	3.5	4.7	2	4.9	2	5.2	

 $C_L=15\text{pF}$ , See Figure 1

Parameter	From Input	TO OUTPUT	$V_{CC}$	$T_A = +25^\circ\text{C}$			$T_A = -40^\circ\text{C to } +85^\circ\text{C}$		$T_A = -40^\circ\text{C to } +125^\circ\text{C}$		Unit
				Min	TYP	Max	Min	Max	Min	Max	
$t_{pd}$	A, B, or C	Y	0.8 V	-	38	-	-	-	-	-	ns
			$1.2\text{ V} \pm 0.1\text{ V}$	3.6	8.4	18.4	3.2	19.8	3.2	20	
			$1.5\text{ V} \pm 0.1\text{ V}$	2.8	6	9.7	2.3	10.5	2.3	11	
			$1.8\text{ V} \pm 0.15\text{ V}$	2.1	5.1	7.9	1.6	8.9	1.6	9.3	
			$2.5\text{ V} \pm 0.2\text{ V}$	1.8	4.2	5.9	1.3	6.6	1.3	7	
			$3.3\text{ V} \pm 0.3\text{ V}$	1.6	3.9	5.2	1.1	5.5	1.1	5.8	

 $C_L=30\text{pF}$ , See Figure 1

Parameter	From Input	TO OUTPUT	$V_{CC}$	$T_A = +25^\circ\text{C}$			$T_A = -40^\circ\text{C to } +85^\circ\text{C}$		$T_A = -40^\circ\text{C to } +125^\circ\text{C}$		Unit
				Min	TYP	Max	Min	Max	Min	Max	
$t_{pd}$	A, B, or C	Y	0.8 V	-	46	-	-	-	-	-	ns
			$1.2\text{ V} \pm 0.1\text{ V}$	4.5	10.7	24	4.1	25.1	4.1	25.5	
			$1.5\text{ V} \pm 0.1\text{ V}$	3.8	7.6	12.3	3.4	13.5	3.4	14.2	
			$1.8\text{ V} \pm 0.15\text{ V}$	3.1	6.3	10.1	2.6	11.3	2.6	11.9	
			$2.5\text{ V} \pm 0.2\text{ V}$	2.6	5.3	7.5	2.1	8.4	2.1	8.9	
			$3.3\text{ V} \pm 0.3\text{ V}$	2.3	5	6.7	1.8	7.1	1.8	7.5	

**Parameter Measurement Information**

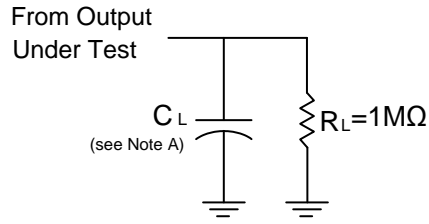

$V_{CC}$	Inputs		$V_M$	$C_L$
	$V_I$	$t_r/t_f$		
0.8 V	$V_{CC}$	$\leq 3ns$	$V_{CC}/2$	5, 10, 15, 30 pF
$1.2V \pm 0.1V$	$V_{CC}$	$\leq 3ns$	$V_{CC}/2$	5, 10, 15, 30 pF
$1.5V \pm 0.1V$	$V_{CC}$	$\leq 3ns$	$V_{CC}/2$	5, 10, 15, 30 pF
$1.8V \pm 0.15V$	$V_{CC}$	$\leq 3ns$	$V_{CC}/2$	5, 10, 15, 30 pF
$2.5V \pm 0.2V$	$V_{CC}$	$\leq 3ns$	$V_{CC}/2$	5, 10, 15, 30 pF
$3.3V \pm 0.3V$	$V_{CC}$	$\leq 3ns$	$V_{CC}/2$	5, 10, 15, 30 pF

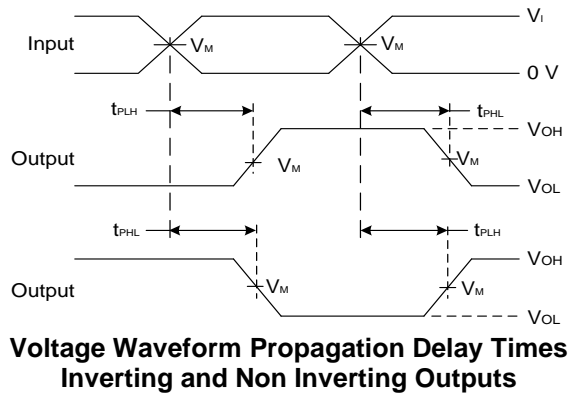
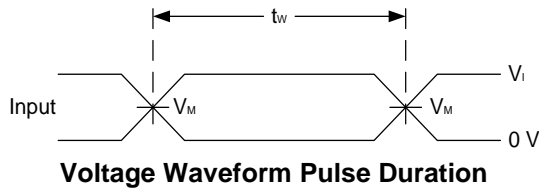
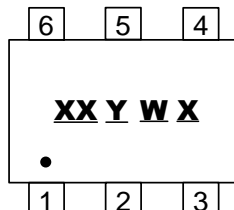

**Figure 1. Load Circuit and Voltage Waveforms**

- Notes:
- A. Includes test lead and test apparatus capacitance.
  - B. All pulses are supplied at pulse repetition rate  $\leq 10$  MHz.
  - C. Inputs are measured separately one transition per measurement.
  - D.  $t_{PLH}$  and  $t_{PHL}$  are the same as  $t_{PD}$ .

**Marking Information**

(1) SOT26, SOT363



XX : Identification code  
Y : Year 0~9  
W : Week : A~Z : 1~26 week;  
 a~z : 27~52 week; z represents  
 52 and 53 week  
X : A~Z : Internal Code

Part Number	Package	Identification Code
74AUP1G98W6	SOT26	AZ
74AUP1G98DW	SOT363	BY

(2) X2-DFN0910-6, X2-DFN1010-6, X2-DFN1410-6

(Top View)

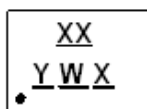

XX : Identification Code  
Y : Year : 0~9  
W : Week : A~Z : 1~26 week;  
 a~z : 27~52 week; z represents  
 52 and 53 week  
X : A~Z : Internal code

Part Number	Package	Identification Code
74AUP1G98FW3	X2-DFN0910-6	AZ
74AUP1G98FW4	X2-DFN1010-6	BY
74AUP1G98FZ4	X2-DFN1410-6	NU

**SOT26 Package Outline Dimensions and Suggested Pad Layout**

Please see AP02002 at <http://www.diodes.com/datasheets/ap02002.pdf> for the latest version.

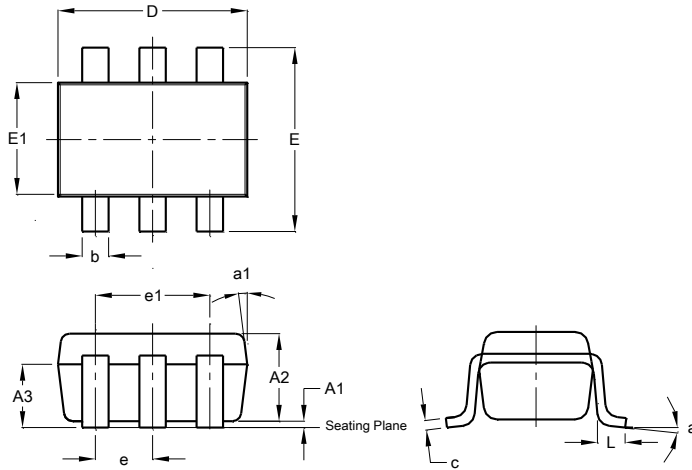

SOT26			
Dim	Min	Max	Typ
A1	0.013	0.10	0.05
A2	1.00	1.30	1.10
A3	0.70	0.80	0.75
b	0.35	0.50	0.38
c	0.10	0.20	0.15
D	2.90	3.10	3.00
e	-	-	0.95
e1	-	-	1.90
E	2.70	3.00	2.80
E1	1.50	1.70	1.60
L	0.35	0.55	0.40
a	-	-	8°
a1	-	-	7°
<b>All Dimensions in mm</b>			

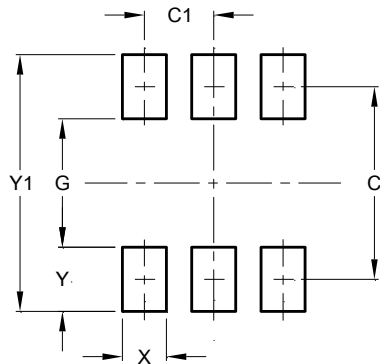

Dimensions	Value (in mm)
C	2.40
C1	0.95
G	1.60
X	0.55
Y	0.80
Y1	3.20

**SOT363 Package Outline Dimensions and Suggested Pad Layout**

Please see AP02002 at <http://www.diodes.com/datasheets/ap02002.pdf> for the latest version.

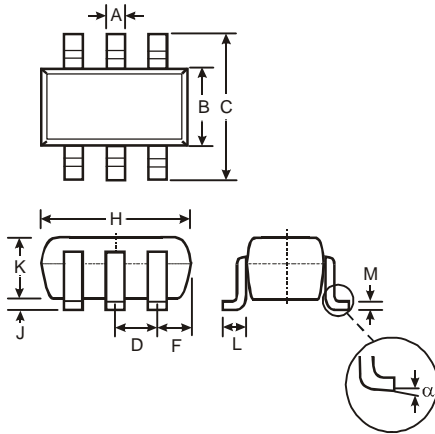

SOT363			
Dim	Min	Max	Typ
A	0.10	0.30	0.25
B	1.15	1.35	1.30
C	2.00	2.20	2.10
D	0.65 Typ		
F	0.40	0.45	0.425
H	1.80	2.20	2.15
J	0	0.10	0.05
K	0.90	1.00	1.00
L	0.25	0.40	0.30
M	0.10	0.22	0.11
α	0°	8°	-
All Dimensions in mm			

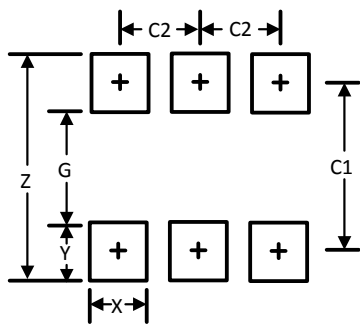

Dimensions	Value (in mm)
Z	2.5
G	1.3
X	0.42
Y	0.6
C1	1.9
C2	0.65

**X2-DFN0910-6 Package Outline Dimensions and Suggested Pad Layout**

Please see AP02002 at <http://www.diodes.com/datasheets/ap02002.pdf> for the latest version.

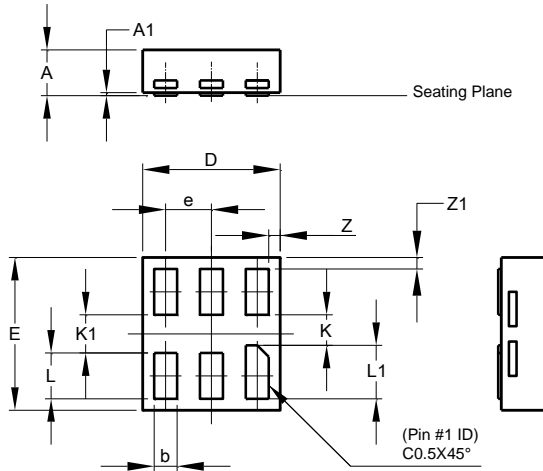

X2-DFN0910-6			
Dim	Min	Max	Typ
A	-	0.35	0.30
A1	0	0.03	0.02
b	0.10	0.20	0.15
D	0.85	0.95	0.90
E	0.95	1.05	1.00
e	-	-	0.30
K	0.20	-	-
K1	0.25	-	-
L	0.25	0.35	0.30
L1	0.30	0.40	0.35
Z	-	-	0.075
Z1	-	-	0.075
All Dimensions in mm			

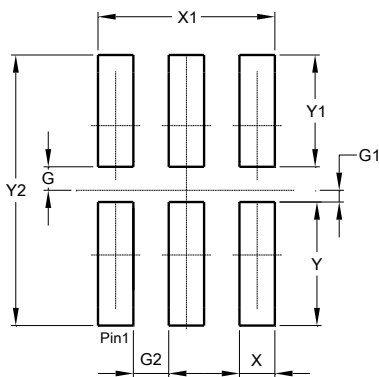

Dimensions	Value (in mm)
G	0.100
G1	0.050
G2	0.150
X	0.150
X1	0.750
Y	0.525
Y1	0.475
Y2	1.150

**X2-DFN1010-6 Package Outline Dimensions and Suggested Pad Layout**

Please see AP02002 at <http://www.diodes.com/datasheets/ap02002.pdf> for the latest version.

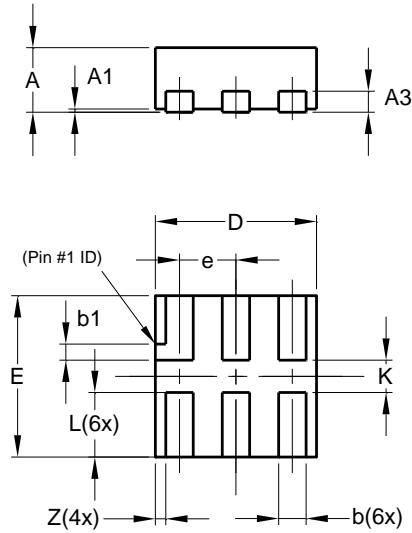

X2-DFN1010-6			
Dim	Min	Max	Typ
A	—	0.40	0.39
A1	0.00	0.05	0.02
A3	—	—	0.13
b	0.14	0.20	0.17
b1	0.05	0.15	0.10
D	0.95	1.05	1.00
E	0.95	1.05	1.00
e	—	—	0.35
L	0.35	0.45	0.40
K	0.15	—	—
Z	—	—	0.065
All Dimensions in mm			

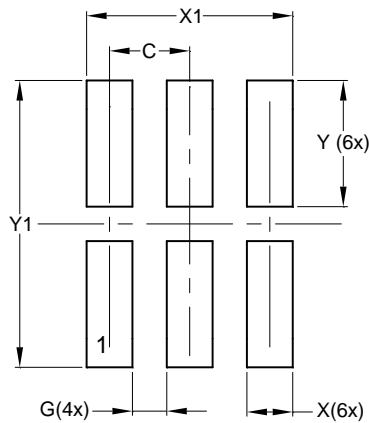

Dimensions	Value (in mm)
C	0.350
G	0.150
X	0.200
X1	0.900
Y	0.550
Y1	1.250

**X2-DFN1410-6 Package Outline Dimensions and Suggested Pad Layout**

Please see AP02002 at <http://www.diodes.com/datasheets/ap02002.pdf> for the latest version.

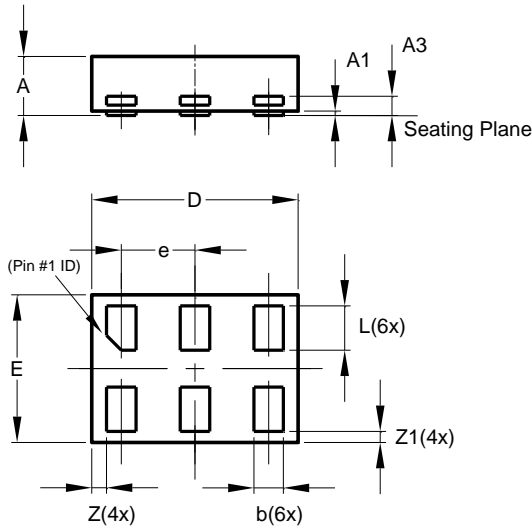

X2-DFN1410-6			
Dim	Min	Max	Typ
A	—	0.40	0.39
A1	0.00	0.05	0.02
A3	—	—	0.13
b	0.15	0.25	0.20
D	1.35	1.45	1.40
E	0.95	1.05	1.00
e	—	—	0.50
L	0.25	0.35	0.30
Z	—	—	0.10
Z1	0.045	0.105	0.075
All Dimensions in mm			

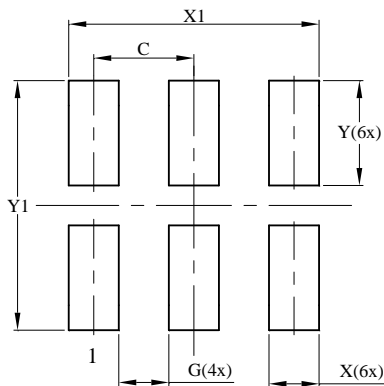

Dimensions	Value (in mm)
C	0.500
G	0.250
X	0.250
X1	1.250
Y	0.525
Y1	1.250



**IMPORTANT NOTICE**

DIODES INCORPORATED MAKES NO WARRANTY OF ANY KIND, EXPRESS OR IMPLIED, WITH REGARDS TO THIS DOCUMENT, INCLUDING, BUT NOT LIMITED TO, THE IMPLIED WARRANTIES OF MERCHANTABILITY AND FITNESS FOR A PARTICULAR PURPOSE (AND THEIR EQUIVALENTS UNDER THE LAWS OF ANY JURISDICTION).

Diodes Incorporated and its subsidiaries reserve the right to make modifications, enhancements, improvements, corrections or other changes without further notice to this document and any product described herein. Diodes Incorporated does not assume any liability arising out of the application or use of this document or any product described herein; neither does Diodes Incorporated convey any license under its patent or trademark rights, nor the rights of others. Any Customer or user of this document or products described herein in such applications shall assume all risks of such use and will agree to hold Diodes Incorporated and all the companies whose products are represented on Diodes Incorporated website, harmless against all damages.

Diodes Incorporated does not warrant or accept any liability whatsoever in respect of any products purchased through unauthorized sales channel. Should Customers purchase or use Diodes Incorporated products for any unintended or unauthorized application, Customers shall indemnify and hold Diodes Incorporated and its representatives harmless against all claims, damages, expenses, and attorney fees arising out of, directly or indirectly, any claim of personal injury or death associated with such unintended or unauthorized application.

Products described herein may be covered by one or more United States, international or foreign patents pending. Product names and markings noted herein may also be covered by one or more United States, international or foreign trademarks.

This document is written in English but may be translated into multiple languages for reference. Only the English version of this document is the final and determinative format released by Diodes Incorporated.

**LIFE SUPPORT**

Diodes Incorporated products are specifically not authorized for use as critical components in life support devices or systems without the express written approval of the Chief Executive Officer of Diodes Incorporated. As used herein:

A. Life support devices or systems are devices or systems which:

1. are intended to implant into the body, or
2. support or sustain life and whose failure to perform when properly used in accordance with instructions for use provided in the labeling can be reasonably expected to result in significant injury to the user.

B. A critical component is any component in a life support device or system whose failure to perform can be reasonably expected to cause the failure of the life support device or to affect its safety or effectiveness.

Customers represent that they have all necessary expertise in the safety and regulatory ramifications of their life support devices or systems, and acknowledge and agree that they are solely responsible for all legal, regulatory and safety-related requirements concerning their products and any use of Diodes Incorporated products in such safety-critical, life support devices or systems, notwithstanding any devices- or systems-related information or support that may be provided by Diodes Incorporated. Further, Customers must fully indemnify Diodes Incorporated and its representatives against any damages arising out of the use of Diodes Incorporated products in such safety-critical, life support devices or systems.

Copyright © 2015, Diodes Incorporated

[www.diodes.com](http://www.diodes.com)