

## STEPPER 2 click

### 2. Soldering the headers

Before using your click board™, make sure to solder 1x8 male headers to both left and right side of the board. Two 1x8 male headers are included with the board in the package.

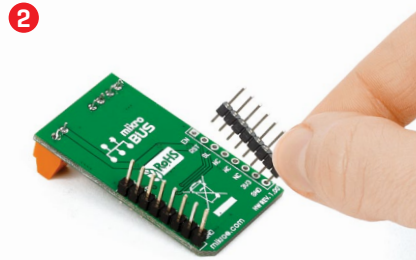
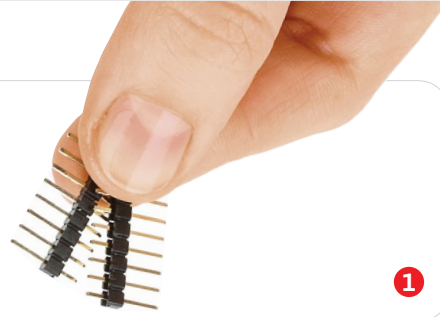

Turn the board upside down so that the bottom side is facing you upwards. Place shorter pins of the header into the appropriate soldering pads.

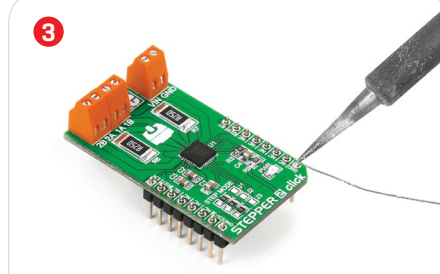

Turn the board upward again. Make sure to align the headers so that they are perpendicular to the board, then solder the pins carefully.

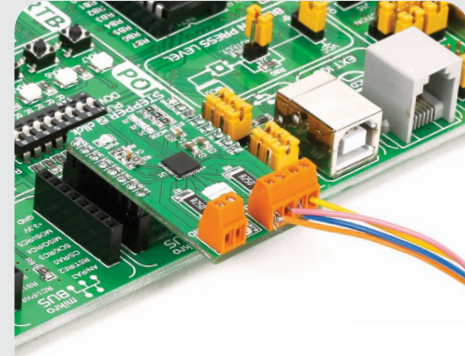

### 4. Essential features

The **A4988 chip** is designed to drive bipolar stepper motors in full-, half-, quarter-, eight-, and sixteenth-step modes. No phase sequence tables are required for operating the driver – a single pulse through the STEP input drives the motor one micro-step. A set of three onboard jumpers [J1-J3] allow you to switch between the different stepping modes (a micro-stepping resolution truth table is provided in the data sheet of the chip). The DIR pin is for determining the direction of rotation of the motor.

### 1. Introduction

Stepper 2 click carries an **A4988 microstepping motor driver** along with screw terminals for connecting an external motor, as well as for bringing in an external power supply. The output drive capacity of the motor is up to 35V and ±2A. The board communicates with the target MCU through EN, RST, SL, ST and DIR pins [corresponding to AN, RST, CS, PWM and INT pins of the default mikroBUS™ configuration]. Stepper 2 click has a 3.3V power supply but is also compatible with 5V logic.

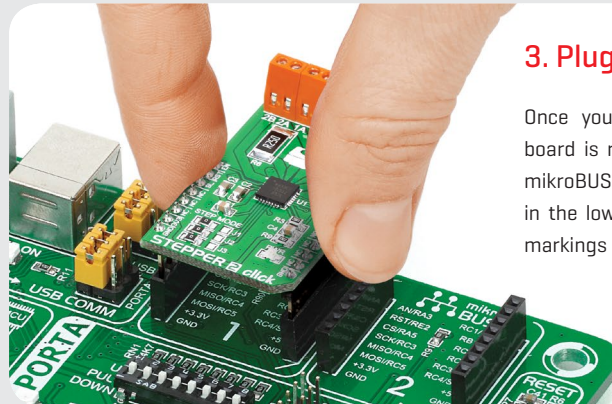

### 3. Plugging the board in

Once you have soldered the headers your board is ready to be placed into the desired mikroBUS™ socket. Make sure to align the cut in the lower-right part of the board with the markings on the silkscreen at the mikroBUS™ socket. If all the pins are aligned correctly, push the board all the way into the socket.

**click**  
BOARD™  
[www.mikroe.com](http://www.mikroe.com)



Stepper 2 click Manual v1.00



010000085769

## 5. Schematic

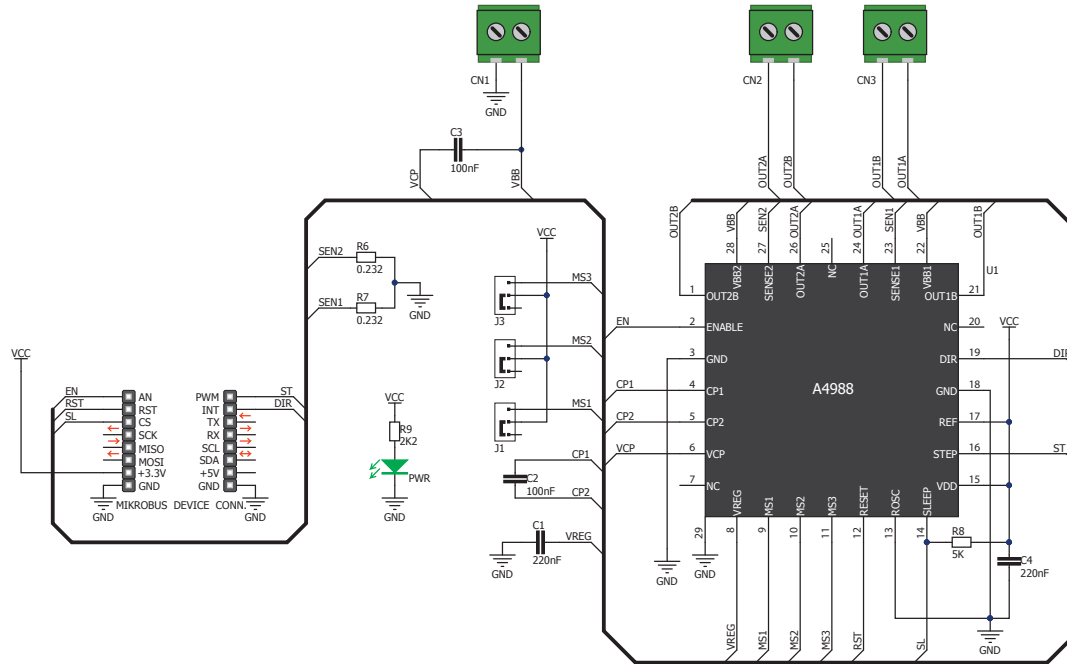

## 6. Dimensions

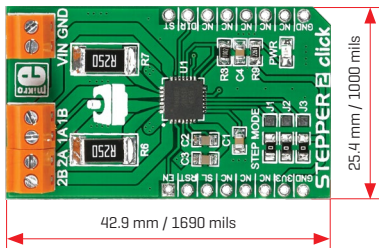

	mm	mils
LENGTH	42.9	1690
WIDTH	25.4	1000
HEIGHT*	3.9	154

\* without headers

## 7. Screw terminals



Stepper 2 click features three pairs of screw terminals. 2B, 2A, 1A and 1B are for connecting the stepper motor, VIN and GND are for bringing an external power supply.

## 8. Code examples

Once you have done all the necessary preparations, it's time to get your click board™ up and running. We have provided examples for mikroC™, mikroBasic™ and mikroPascal™ compilers on our **Libstock** website. Just download them and you are ready to start.



## 9. Support

MikroElektronika offers **free tech support** [[www.mikroe.com/support](http://www.mikroe.com/support)] until the end of the product's lifetime, so if something goes wrong, we're ready and willing to help!



## 10. Disclaimer

MikroElektronika assumes no responsibility or liability for any errors or inaccuracies that may appear in the present document. Specification and information contained in the present schematic are subject to change at any time without notice.

Copyright © 2015 MikroElektronika.  
All rights reserved.