

LuxiGen™ Multi-Color Emitter Series
LZ7 Flat Lens Emitter
RGBW-PC Amber-Cyan-Violet

LZ7-04MU00

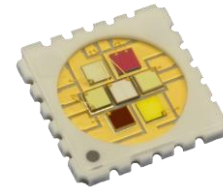

Key Features

- 7-color surface mount ceramic LED package with integrated flat glass lens
- Red, Green, Blue, Cool White, PC Amber, Cyan and Violet enables richer and wider color combination for more sophisticated color mixing
- Compact 3.8mm Light Emitting Surface (LES) and low profile package maximize coupling efficiency into secondary optics
- 20W max power dissipation in a small 7.0mm x 7.0mm emitter footprint
- Thermal resistance of 1.4 °C/W; up to 1.5A maximum drive current for individual die
- Electrically neutral thermal path
- JEDEC Level 1 for Moisture Sensitivity Level
- Lead (Pb) free and RoHS compliant

Typical Applications

- Stage and Studio Lighting
- Effect Lighting
- Accent Lighting
- Display Lighting
- Architectural Lighting

Description

The LZ7 flat lens emitter contains 7 different colors LED dies closely packed in a low thermal resistance package with integrated glass window. The addition of PC Amber, Cyan and Violet to the traditional RGBW colors enables richer and wider color combination for more sophisticated color mixing. The compact 3.8mm LES, low profile package and glass window, allows maximum coupling efficiency into the zoom optics, mixing rods, light pipes and other secondary optics. The high quality materials used in the package are chosen to maximize light output and minimize stresses which results in monumental reliability and lumen maintenance.

Notes

This product emits Violet and Blue light, which can be hazardous depending on total system configuration (including, but not limited to optics, drive current and temperature). Do not stare directly into the beam and observe safety precaution given in IEC 62471 when operating this product.

Part number options

Base part number

Part number	Description
LZ7-04MU00-0000	LZ7 RGBW-PC Amber-Cyan-Violet flat lens emitter
LZ7-N4MU00-0000	LZ7 RGBW-PC Amber-Cyan-Violet flat lens emitter on 7 channel MCPCB

Bin kit option codes

MU, Red-Green-Blue-White (6500K)-PC Amber-Cyan-UV			
Kit number suffix	Min flux Bin	Color Bin Ranges	Description
0000	07R1	R01	Red, full distribution flux; full distribution wavelength
	10G1	G2 – G3	Green, full distribution flux; full distribution wavelength
	09B	B03	Blue, full distribution flux; full distribution wavelength
	11W1	1V2U	White full distribution flux and CCT
	KL	PCA	PC Amber, full distribution flux; full distribution wavelength
	01C	C14	Cyan, full distribution flux; full distribution wavelength
	01U	U56	Violet, full distribution flux; full distribution wavelength

Daylight White Chromaticity Group

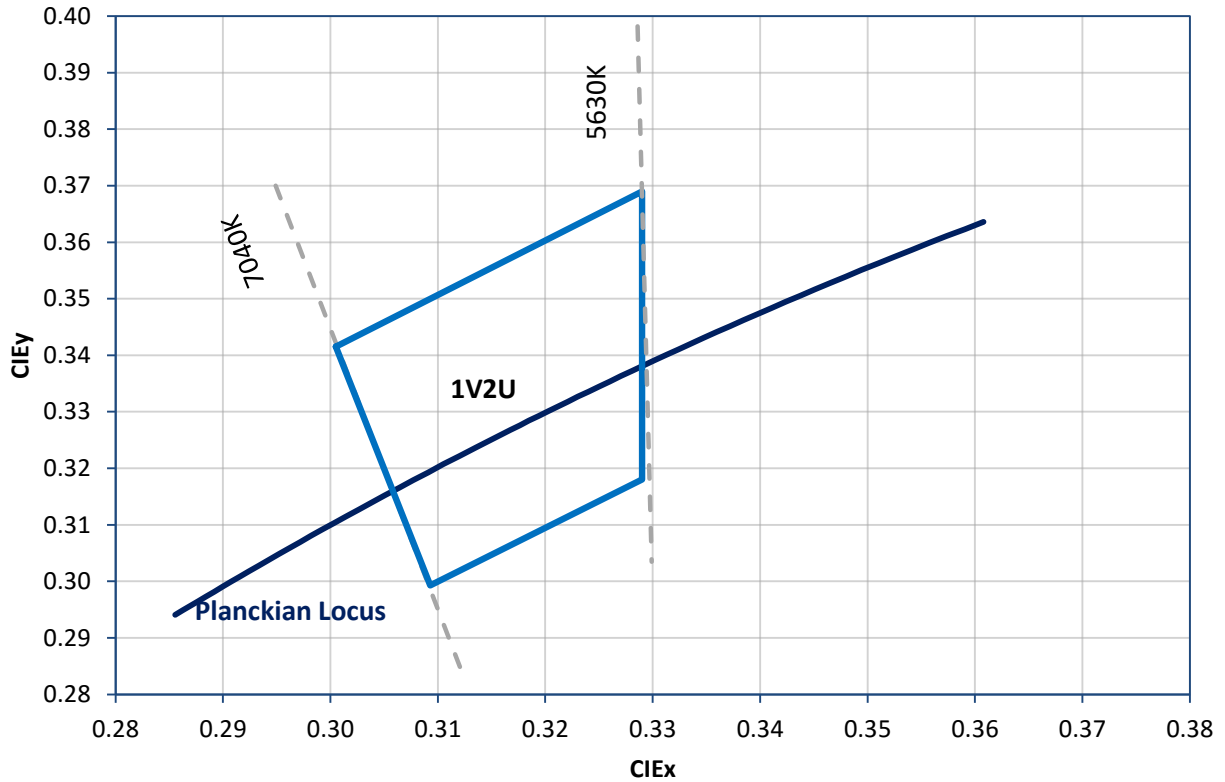

Standard Chromaticity Group plotted on excerpt from the CIE 1931 (2°) x-y Chromaticity Diagram. Coordinates are listed below.

Daylight White Bin Coordinates

Bin Code	CIEx	CIEy
1V2U	0.3005	0.3415
	0.3290	0.3690
	0.3290	0.3180
	0.3093	0.2993
	0.3005	0.3415

PC Amber Chromaticity Group

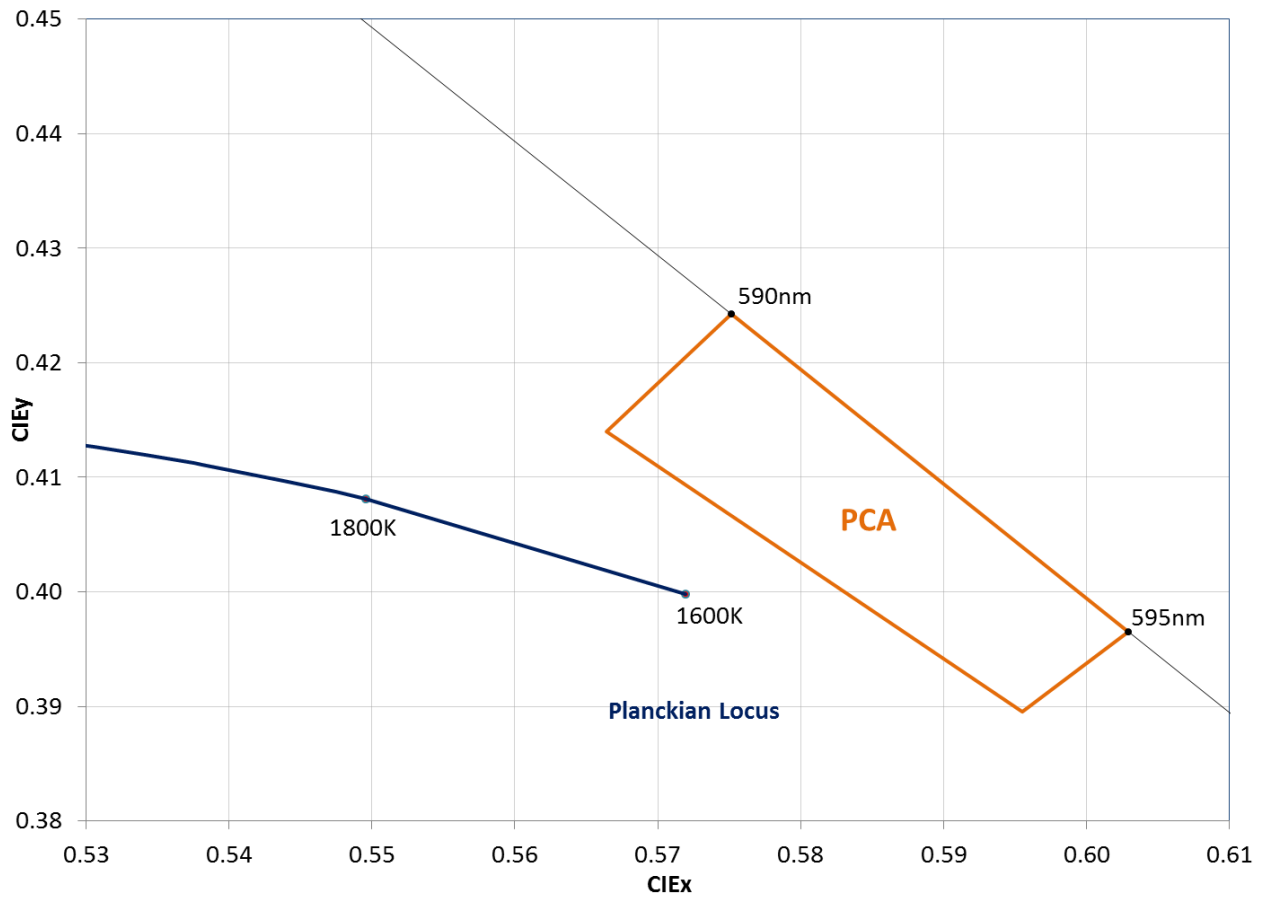

Standard Chromaticity Group plotted on excerpt from the CIE 1931 (2°) x-y Chromaticity Diagram. Coordinates are listed below.

PC Amber Bin Coordinates

Bin Code	CIEx	CIEy
PCA	0.5752	0.4242
	0.5664	0.4140
	0.5955	0.3895
	0.6029	0.3965
	0.5752	0.4242

Flux Bins

Table 1:

Bin Code	Minimum Flux @ $I_f = 700\text{mA}^{[1]}$							Maximum Flux @ $I_f = 700\text{mA}^{[1]}$						
	Luminous (lm)							Radiant (mW)						
	Red	Green	Blue	White	PC Amber	Cyan	Violet	Red	Green	Blue	White	PC Amber	Cyan	Violet
07R1	60							79						
07R2	79							105						
10G1		100							128					
10G2		128							166					
09B			13							22				
10B			22							35				
11W1				160							200			
11W2				200							255			
KL					75							117		
01C						71							130	
01U							700							1100

Notes for Table 1:

- Flux performance is measured at 10ms pulse, $T_c = 25^\circ\text{C}$. LED Engin maintains a tolerance of $\pm 10\%$ on flux measurements.

Wavelength Bins

Table 2:

Bin Code	Minimum Wavelength @ $I_f = 700\text{mA}^{[1,2]}$					Maximum Wavelength @ $I_f = 700\text{mA}^{[1,2]}$				
	Dominant (λ_D) (nm)					Dominant (λ_D) (nm)				
	Red	Green	Blue	Cyan	Violet	Red	Green	Blue	Cyan	Violet
R01	617					630				
G2		520					525			
G3		525					530			
B03			453					460		
C14				490					510	
U56					390					400

Notes for Table 2:

- Wavelength is measured at 10ms pulse, $T_c = 25^\circ\text{C}$.
- LED Engin maintains a tolerance of $\pm 1.0\text{nm}$ on dominant wavelength measurements and $\pm 2.0\text{nm}$ on peak wavelength measurements.

Forward Voltage Bin

Table 3:

Bin Code	Minimum Forward Voltage (V_f) @ $I_f = 700\text{mA}^{[1]}$ (V)							Maximum Forward Voltage (V_f) @ $I_f = 700\text{mA}^{[1]}$ (V)						
	Red	Green	Blue	White	PC Amber	Cyan	Violet	Red	Green	Blue	White	PC Amber	Cyan	Violet
	0	2.1	3.2	2.8	2.8	2.8	2.9	3.2	2.9	4.2	3.8	3.8	3.8	4.0

Notes for Table 3:

- Forward voltage is measured at 10ms pulse, $T_c = 25^\circ\text{C}$. LED Engin maintains a tolerance of $\pm 0.04\text{V}$ for forward voltage measurements.

Absolute Maximum Ratings

Table 4:

Parameter	Symbol	Value	Unit
DC Forward Current (@T _J = 125°C) – R, G, B, or W single die on	I _{F(MAX)}	1500	mA
DC Forward Current (@T _J = 125°C) – PC-A, C or V single die on	I _{F(MAX)}	1000	mA
DC Forward Current (@T _J = 125°C) – all 7 die on ^[1]	I _{F(MAX)}	850	mA
Peak Pulsed Forward Current ^[2]	I _{FP}	2000	mA
Power Dissipation	P _d	20	W
Reverse Voltage	V _R	See Note 3	V
Storage Temperature	T _{std}	-40 ~ +150	°C
Junction Temperature	T _{J(MAX)}	125	°C
Soldering Temperature ^[4]	T _{sol}	260	°C

Notes for Table 4:

- Maximum DC forward current is determined by the overall thermal resistance and ambient temperature. Follow the curves in Figure 11 for current derating.
- Pulse forward current conditions: Pulse Width ≤ 10msec and Duty Cycle ≤ 10%.
- LEDs are not designed to be reverse biased.
- Solder conditions per JEDEC 020D. See Reflow Soldering Profile Figure 3.
- LED Engin recommends taking reasonable precautions towards possible ESD damages and handling the emitter in an electrostatic protected area (EPA). An EPA may be adequately protected by ESD controls as outlined in ANSI/ESD S6.1.

Optical Characteristics @T_C = 25°C

Table 5:

Parameter	Symbol	Typical							Unit
		Red	Green	Blue ^[1]	White	PC Amber	Cyan	Violet ^[2]	
Luminous Flux (@ I _F = 700mA)	Φ _V	80	140	33	200	100	95		lm
Luminous Flux (@ I _F = 1000mA)	Φ _V	110	180	45	270	130	120		lm
Luminous Flux (@ I _F = 1500mA)	Φ _V	160	220	60	350				lm
Radiant Flux (@ I _F = 700mA)	Φ							0.80	W
Radiant Flux (@ I _F = 1000mA)	Φ							1.10	W
Dominant Wavelength	λ _D	623	523	457		592	500		nm
Peak Wavelength	λ _P							395	nm
Correlated Color Temperature	CCT				6500				K
Color Rendering Index (CRI)	R _a				75				
Viewing Angle ^[3]	2Θ _½				120				Degrees
Total Included Angle ^[4]	Θ _{0.9}				160				Degrees

Notes for Table 5:

- When operating the Blue LED, observe IEC 62471 Risk Group 2 rating. Do not stare into the beam.
- When operating the UV LED, observe IEC 62471 Risk Group 3 rating. Do not stare into the beam.
- Viewing Angle is the off axis angle from emitter centerline where the luminous intensity is ½ of the peak value.
- Total Included Angle is the total angle that includes 90% of the total luminous flux.

Electrical Characteristics @T_C = 25°C

Table 6:

Parameter	Symbol	Typical							Unit
		Red	Green	Blue	White	PC Amber	Cyan	Violet	
Forward Voltage (@ I _F = 700mA)	V _F	2.5	3.6	3.2	3.2	3.2	3.6	3.7	V
Temperature Coefficient of Forward Voltage	ΔV _F /ΔT _J	-1.9	-2.9	-2.0	-2.0	-2.0	-2.6	-2.2	mV/°C
Thermal Resistance (Junction to Case)	RO _{J-C}				1.4				°C/W

IPC/JEDEC Moisture Sensitivity Level

Table 7 - IPC/JEDEC J-STD-20D.1 MSL Classification:

Level	Floor Life		Soak Requirements			
	Time	Conditions	Standard	Accelerated	Time (hrs)	Conditions
1	Unlimited	≤ 30°C/ 85% RH	168 +5/-0	85°C/ 85% RH	n/a	n/a

Notes for Table 7:

1. The standard soak time includes a default value of 24 hours for semiconductor manufacturer's exposure time (MET) between bake and bag and includes the maximum time allowed out of the bag at the distributor's facility.

Mechanical Dimensions (mm)

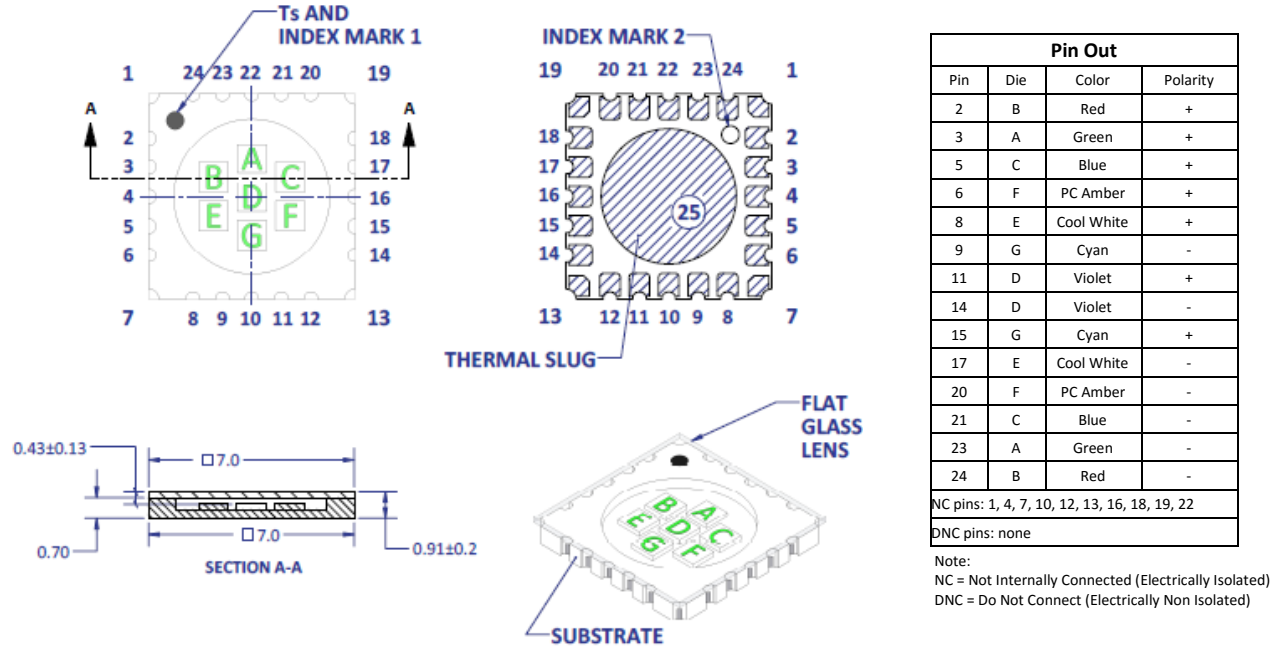

Figure 1: Package Outline Drawing

Notes for Figure 1:

1. Unless otherwise noted, the tolerance = ± 0.20 mm.
2. Thermal contact, Pad 25, is electrically neutral.
3. Temperature measurement point: side ceramic closest to the Ts point

Recommended Solder Pad Layout (mm)

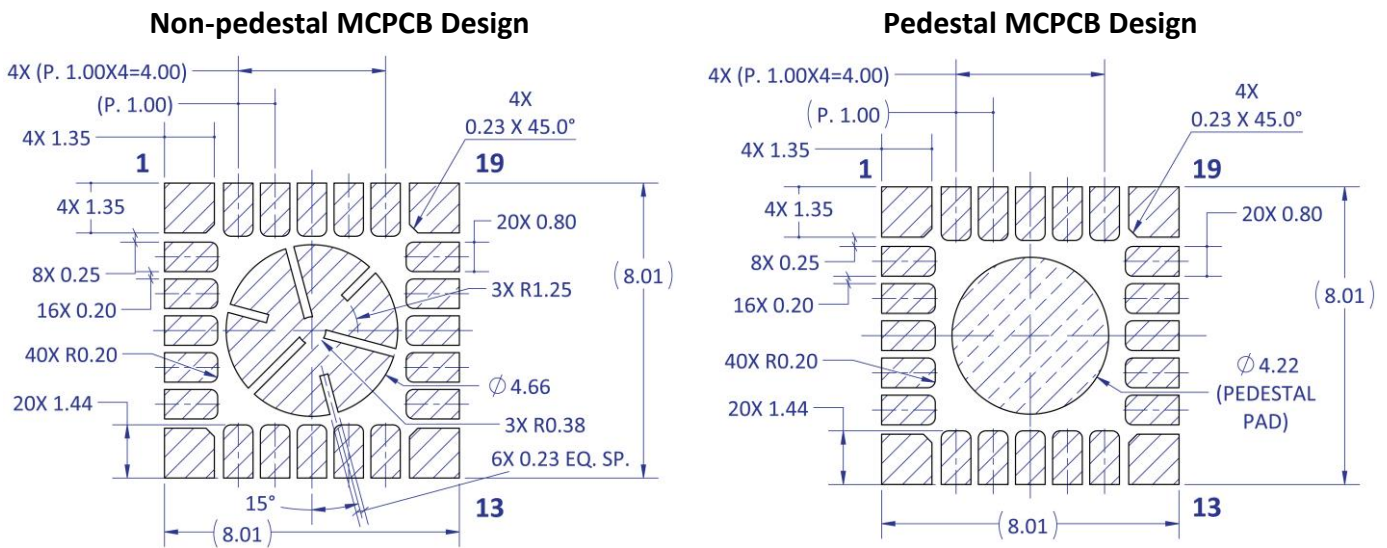

Figure 2a: Recommended solder pad layout for anode, cathode, and thermal pad for non-pedestal and pedestal design

Note for Figure 2a:

1. Unless otherwise noted, the tolerance = ± 0.20 mm.
2. Pedestal MCPCB allows the emitter thermal slug to be soldered directly to the metal core of the MCPCB. Such MCPCB eliminate the high thermal resistance dielectric layer that standard MCPCB technologies use in between the emitter thermal slug and the metal core of the MCPCB, thus lowering the overall system thermal resistance.
3. LED Engin recommends x-ray sample monitoring for solder voids underneath the emitter thermal slug. The total area covered by solder voids should be less than 20% of the total emitter thermal slug area. Excessive solder voids will increase the emitter to MCPCB thermal resistance and may lead to higher failure rates due to thermal over stress.

Recommended Solder Mask Layout (mm)

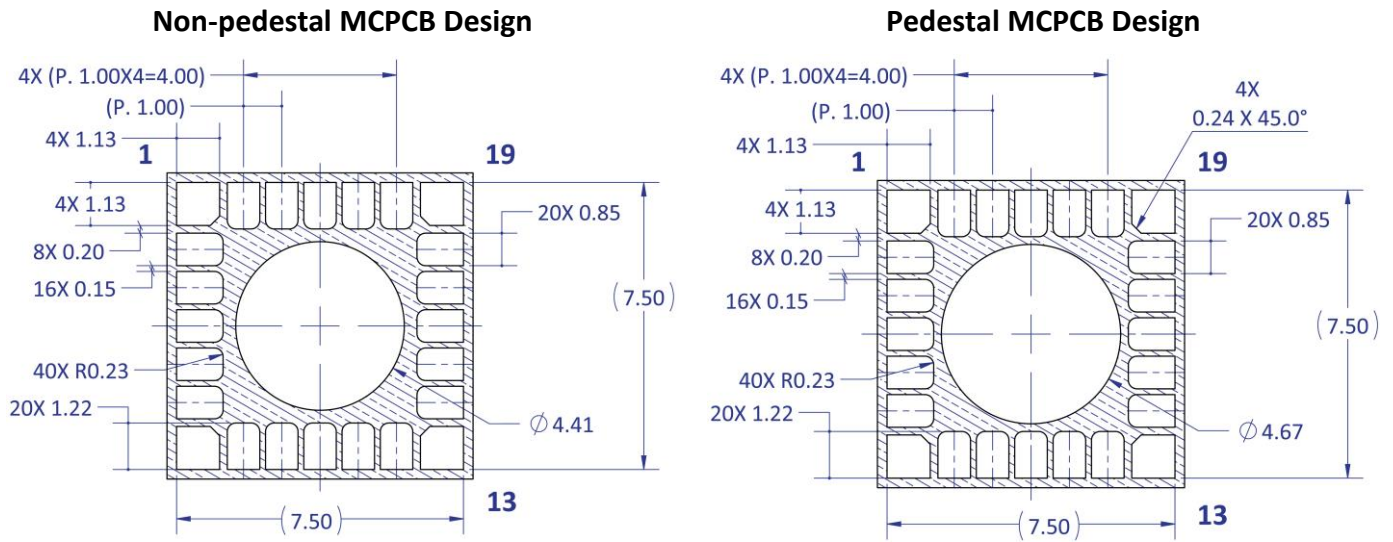

Figure 2b: Recommended solder mask opening for anode, cathode, and thermal pad for non-pedestal and pedestal design

Note for Figure 2b:

1. Unless otherwise noted, the tolerance = ± 0.20 mm.

Recommended 8 mil Stencil Apertures Layout (mm)

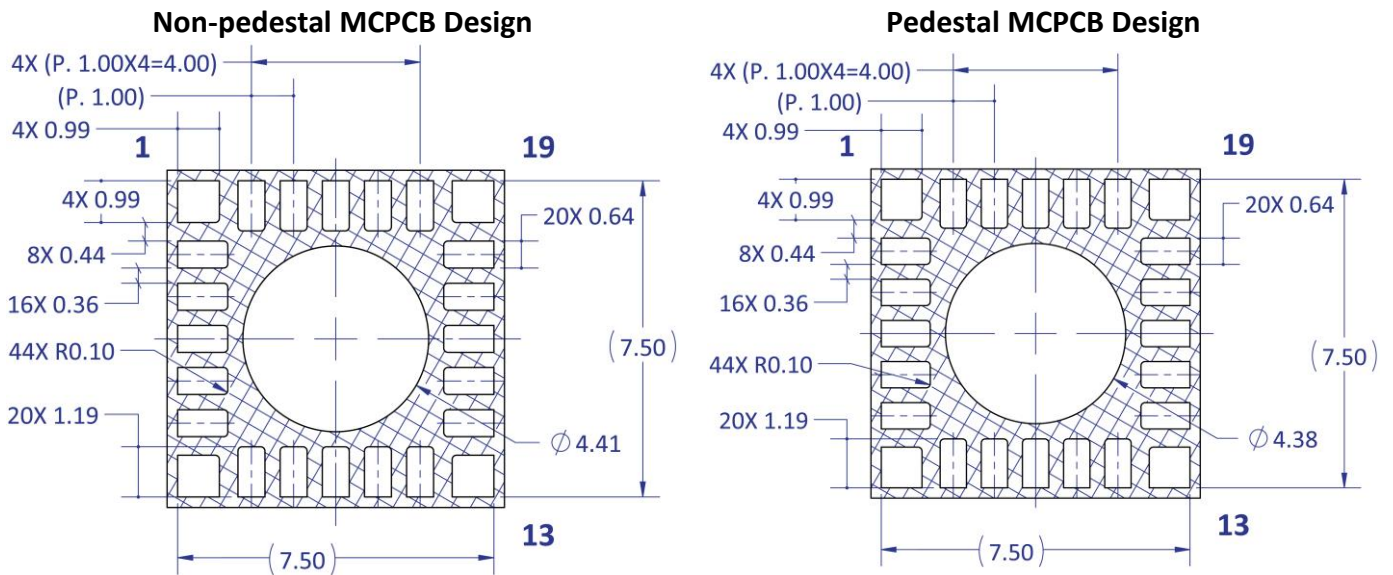

Figure 2c: Recommended 8mil stencil apertures layout for anode, cathode, and thermal pad for non-pedestal and pedestal design

Note for Figure 2c:

1. Unless otherwise noted, the tolerance = ± 0.20 mm.

Reflow Soldering Profile

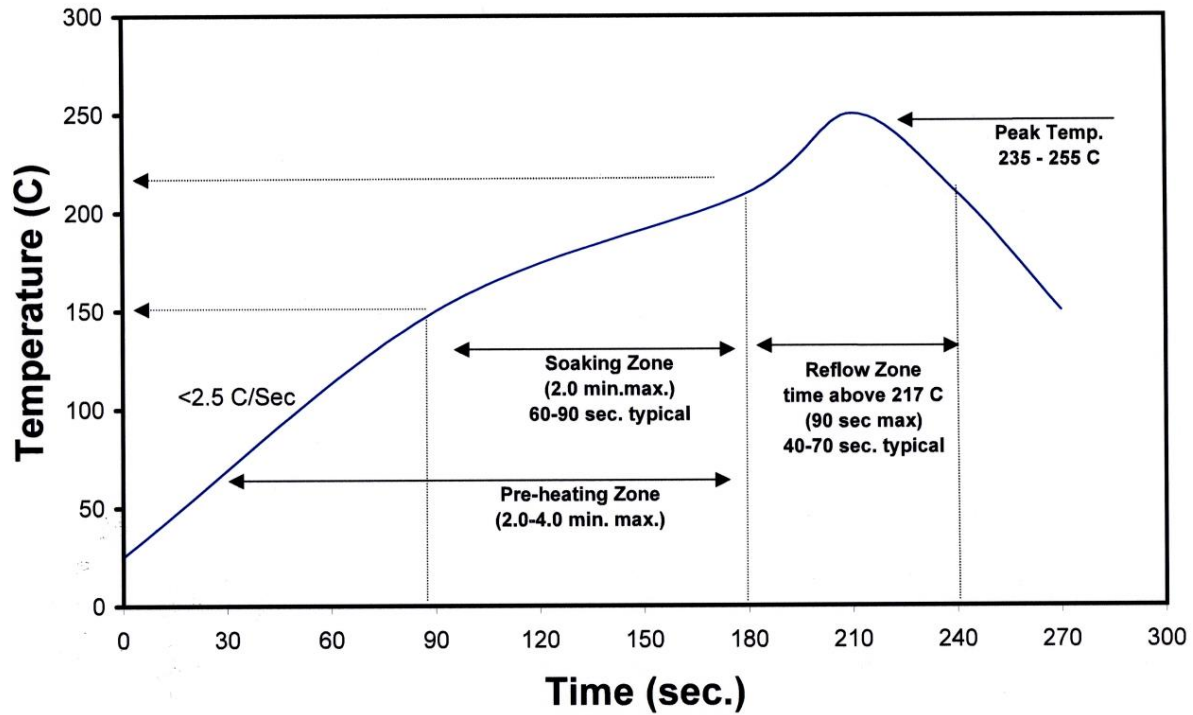

Figure 3: Reflow soldering profile for lead free soldering

Typical Radiation Pattern

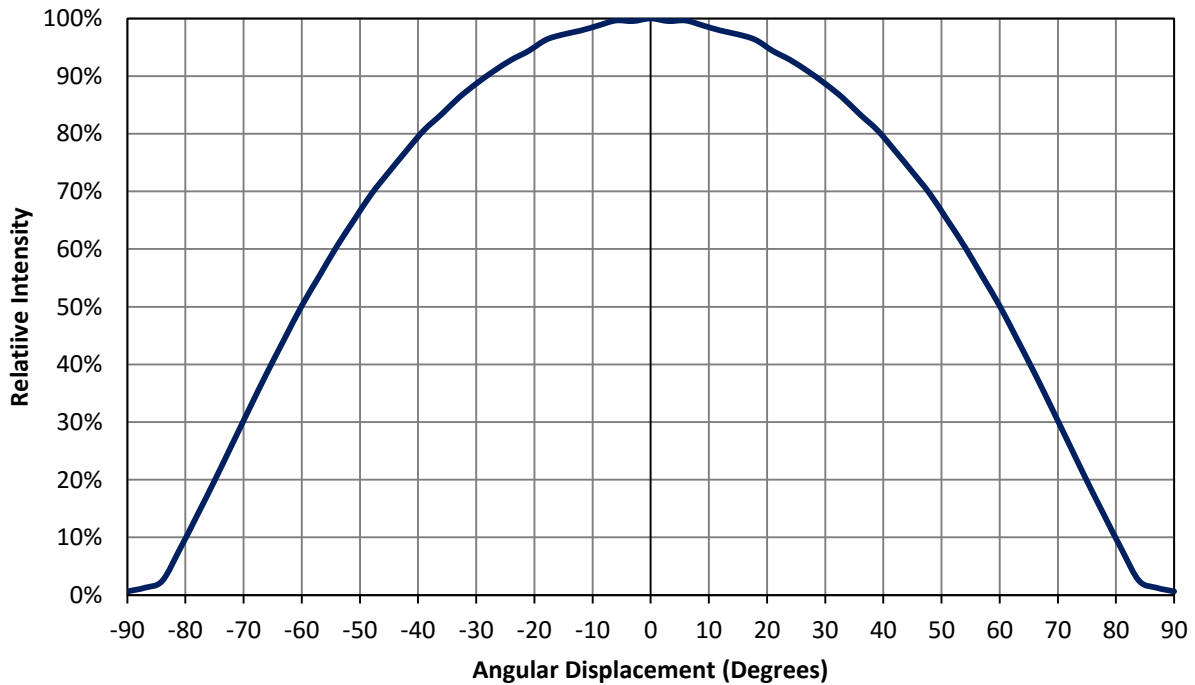

Figure 4: Typical representative spatial radiation pattern – all dies on

Typical Relative Spectral Power Distribution

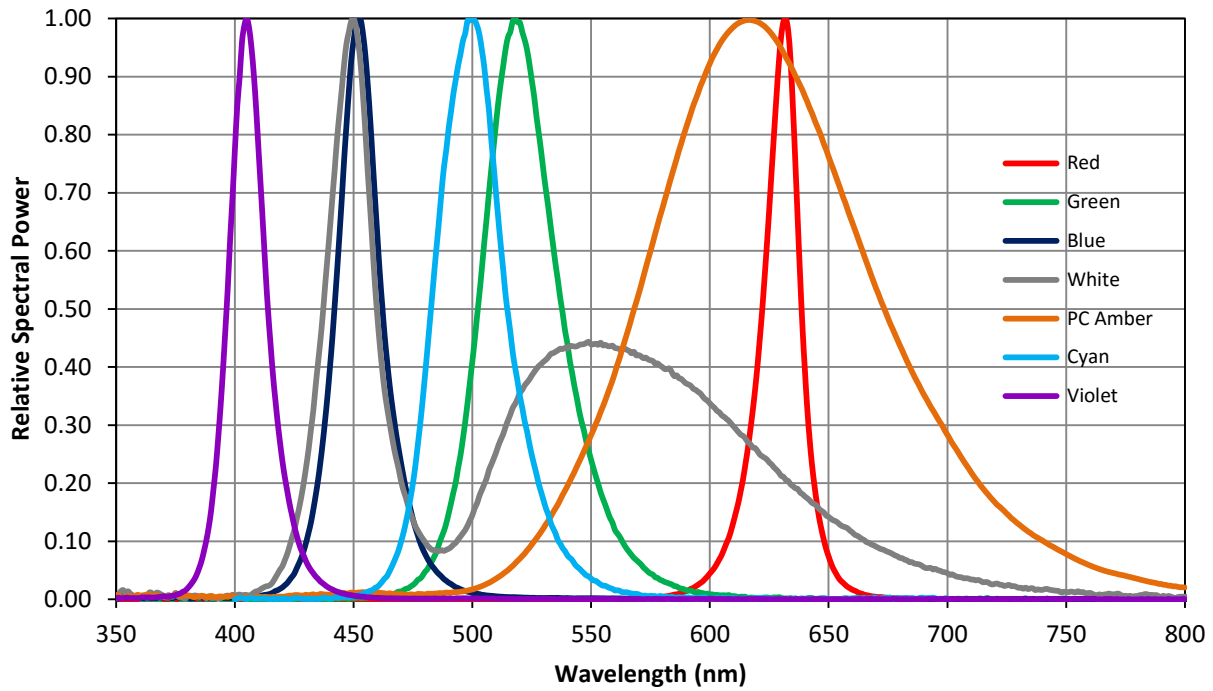

Figure 5: Typical relative spectral power vs. wavelength @ T_c = 25°C.

Typical Forward Current Characteristics

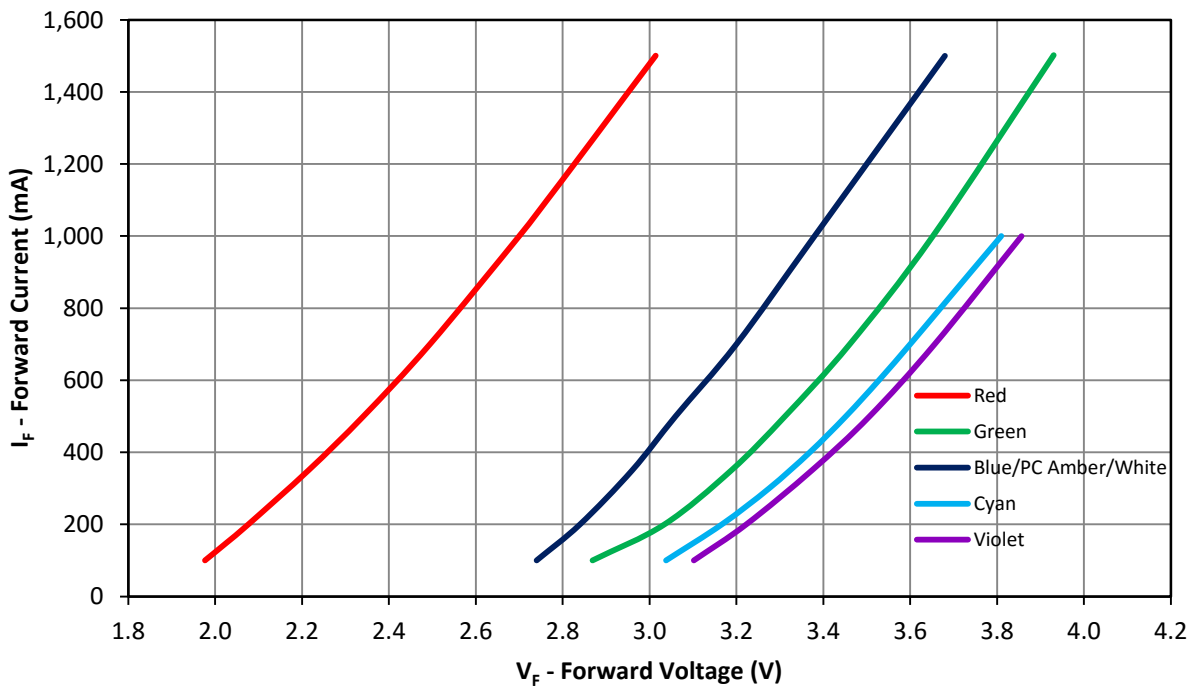

Figure 6: Typical forward current vs. forward voltage @ T_c = 25°C

Typical Relative Flux over Current

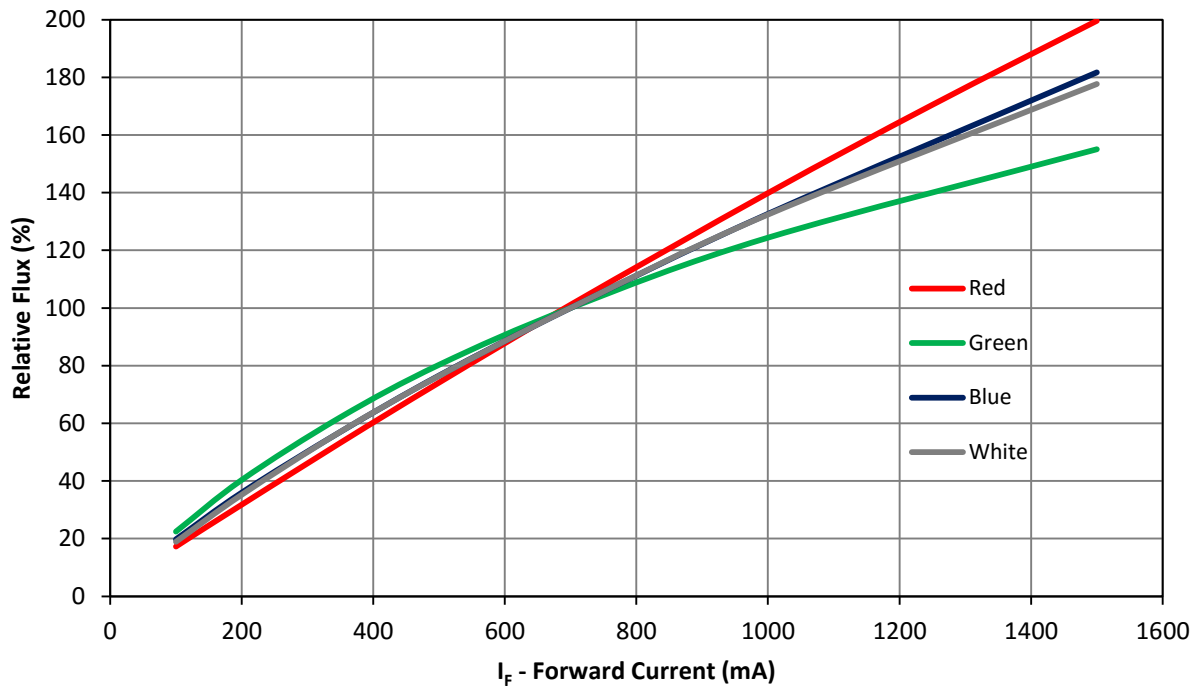

Figure 7a: Typical relative luminous (radiant for Violet) flux vs. forward current @ $T_c = 25^\circ\text{C}$ – R, G, B, W

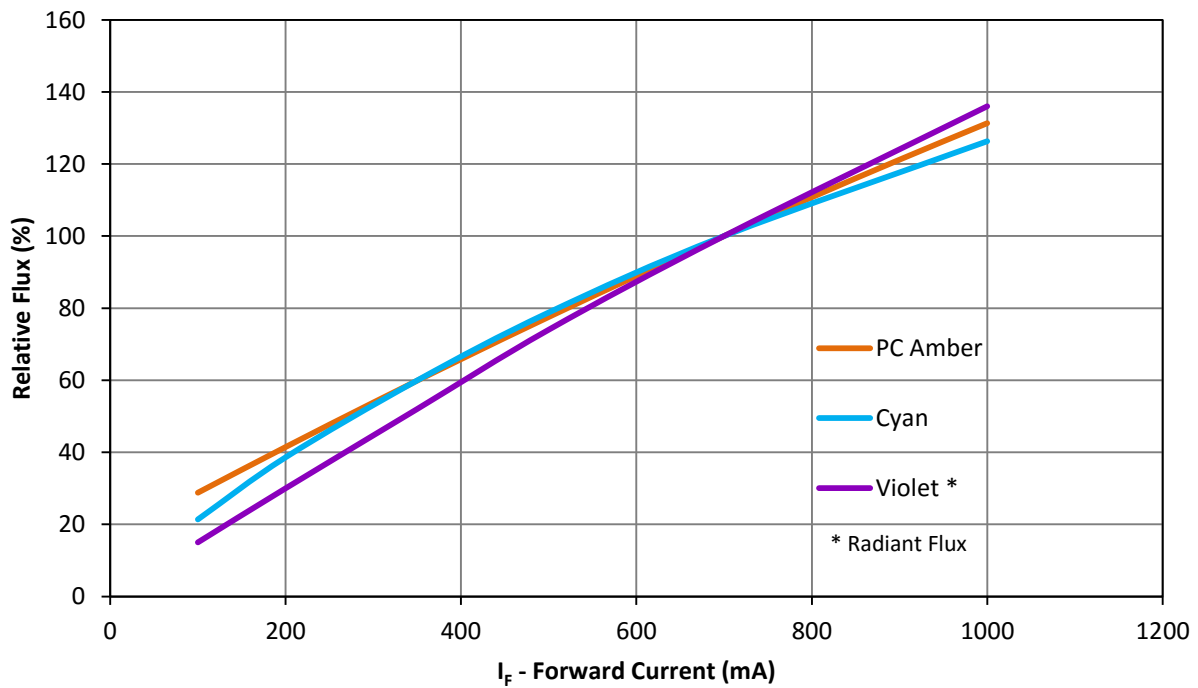

Figure 7b: Typical relative luminous (radiant for Violet) flux vs. forward current @ $T_c = 25^\circ\text{C}$ – PC-A, C, V

Typical Relative Flux over Temperature

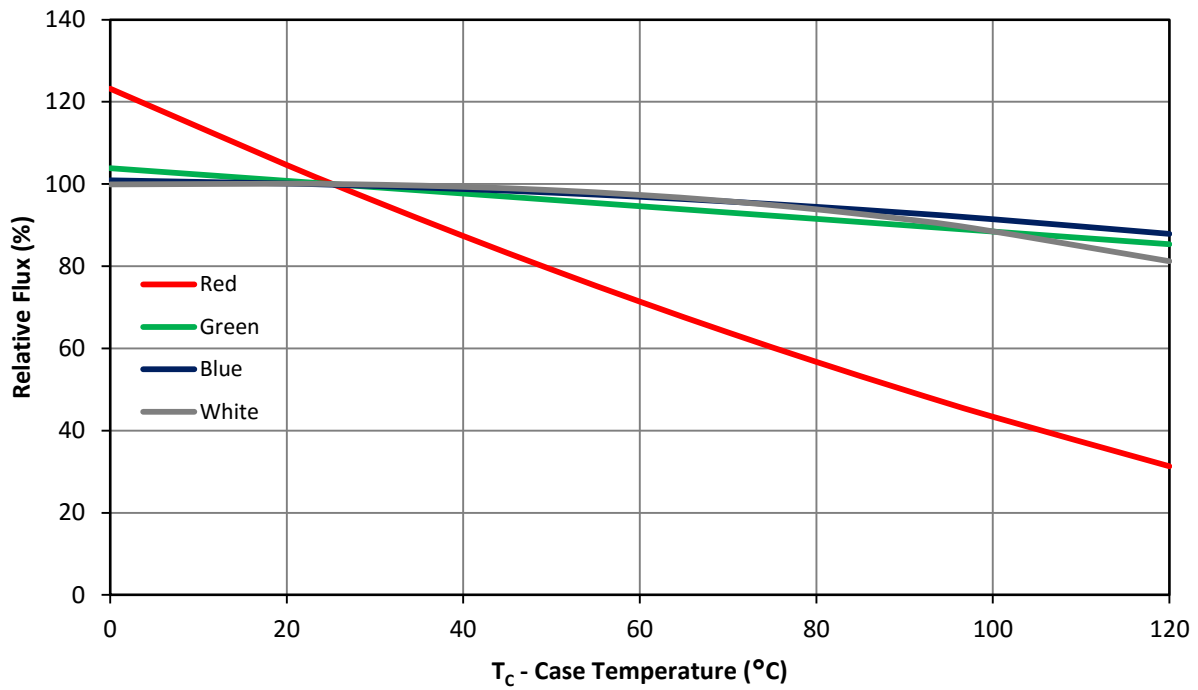

Figure 8a: Typical relative luminous flux vs. case temperature – R, G, B, W

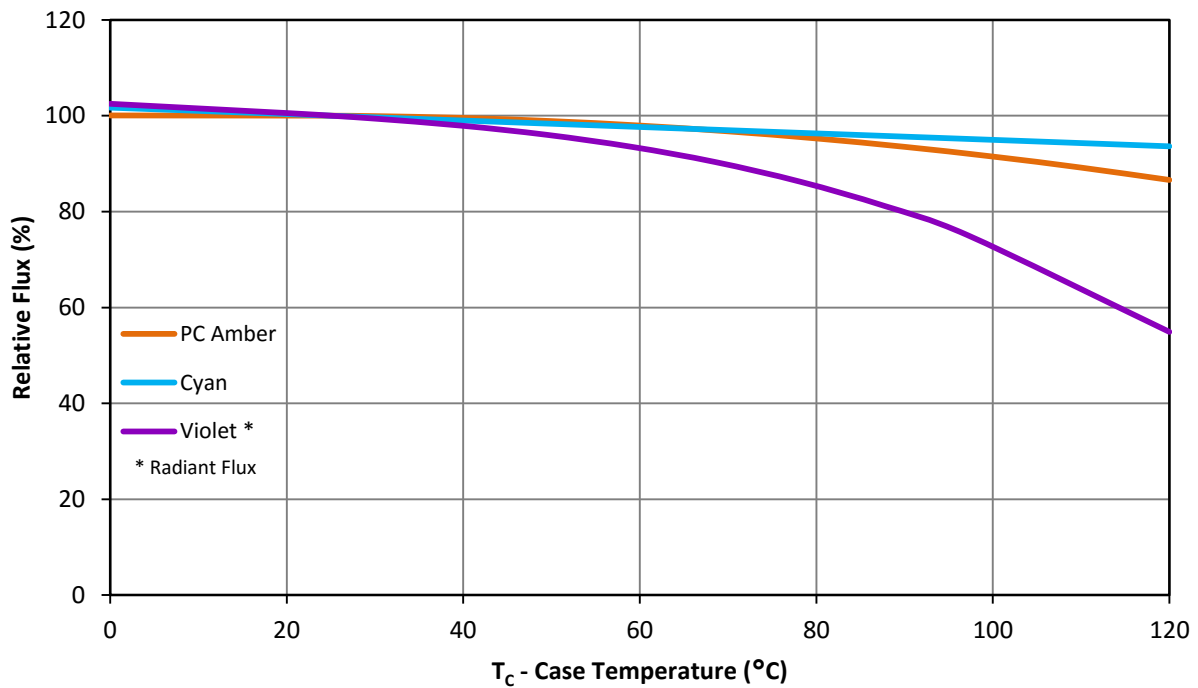

Figure 8b: Typical relative luminous (radiant for Violet) flux vs. case temperature – PC-A, C, V

Typical Wavelength Shift over Current

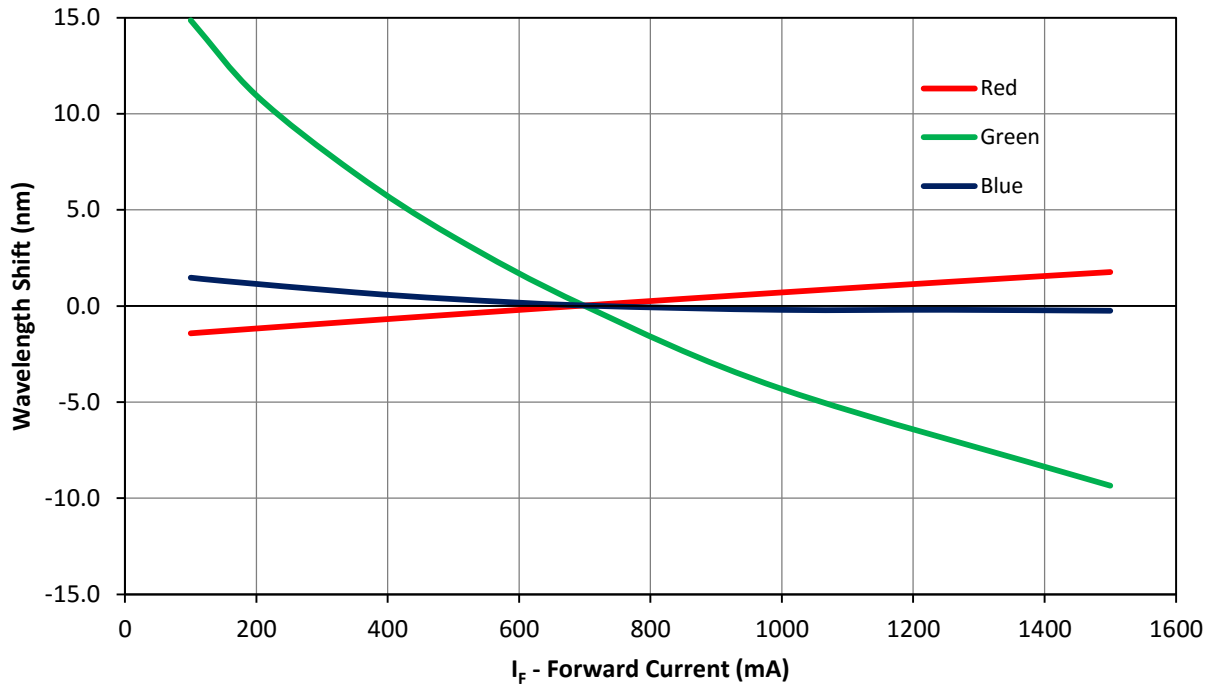

Figure 9a: Typical dominant wavelength shift vs. forward current @ $T_c = 25^\circ\text{C}$ – R, G, B

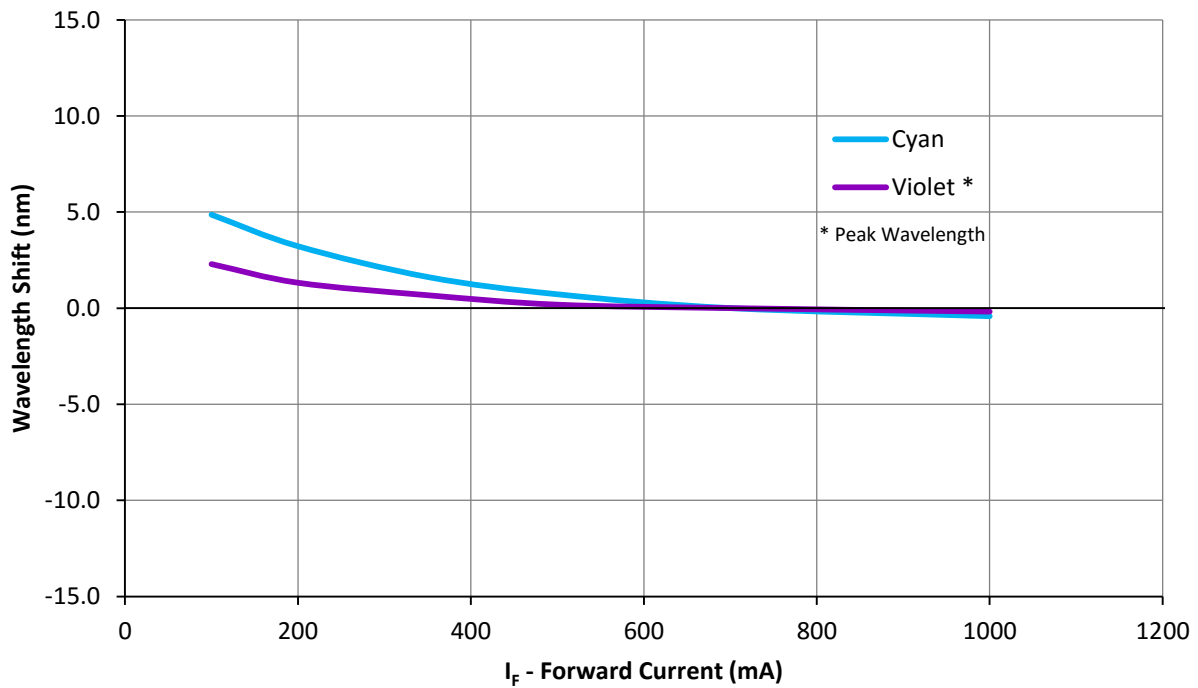

Figure 9b: Typical dominant (peak for Violet) wavelength shift vs. forward current @ $T_c = 25^\circ\text{C}$ – C, V

Typical Chromaticity Coordinate Shift over Current

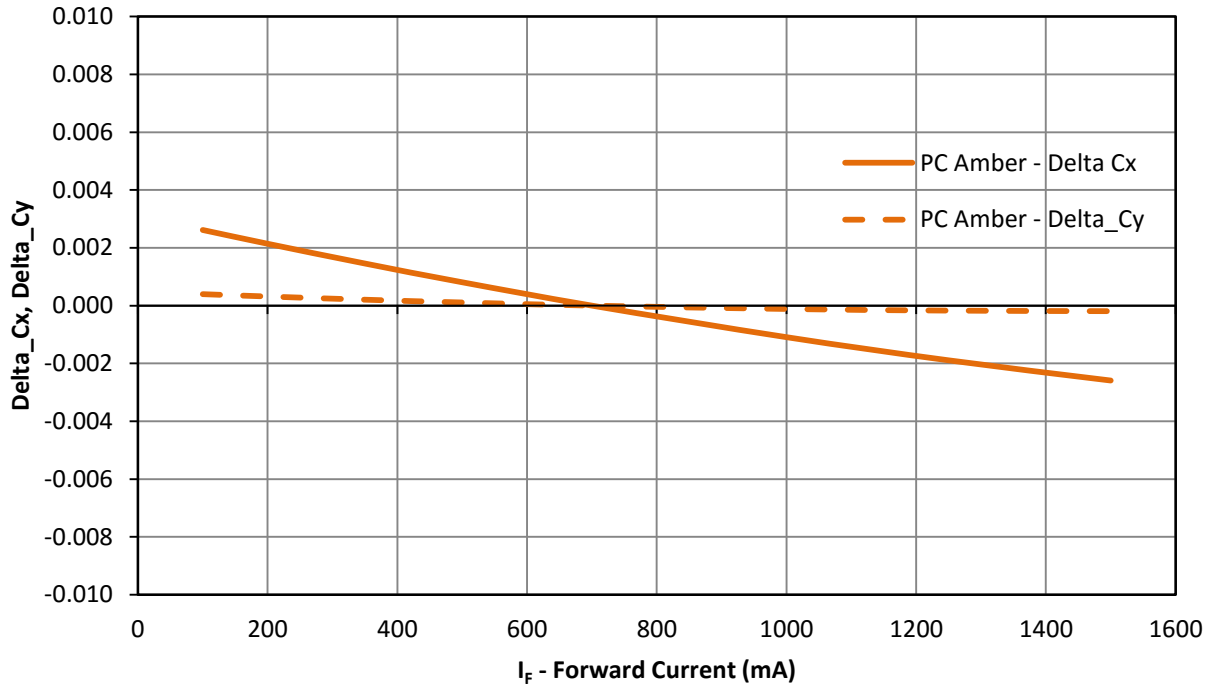

Figure 9c: Typical chromaticity coordinate shift vs. forward current @ $T_c = 25^\circ\text{C}$ – PC Amber

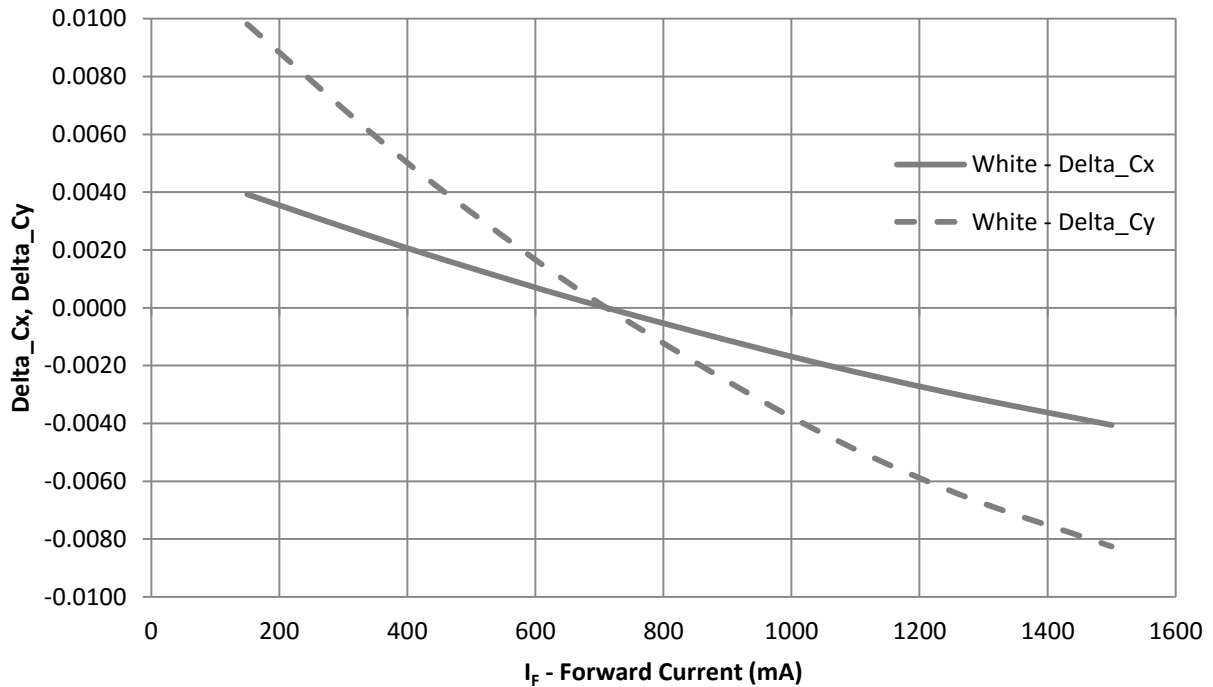

Figure 9d: Typical chromaticity coordinate shift vs. forward current @ $T_c = 25^\circ\text{C}$ - White

Typical Wavelength Shift over Temperature

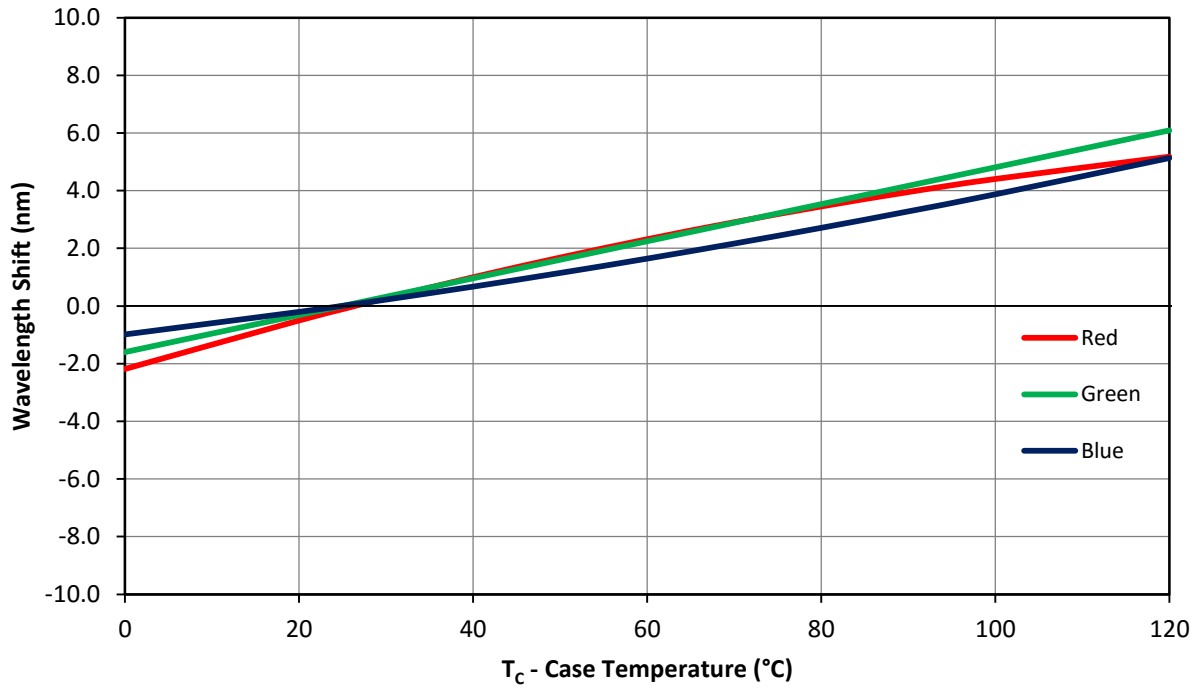

Figure 10a: Typical dominant wavelength shift vs. case temperature – R, G, B

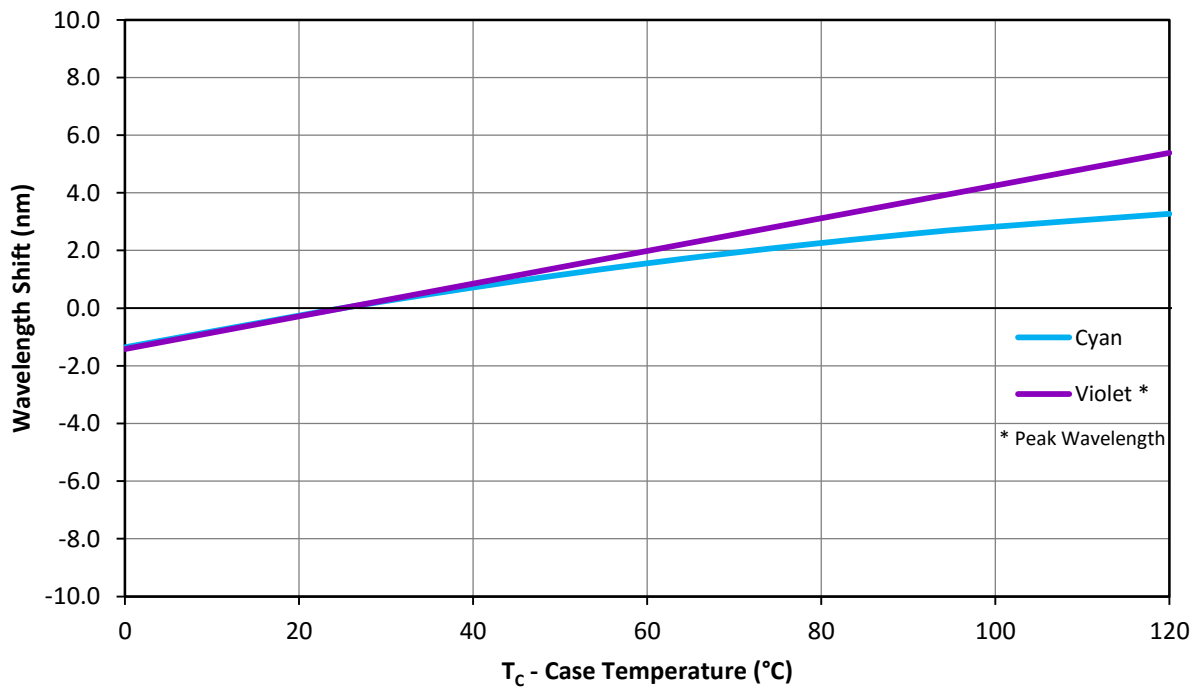

Figure 10b: Typical dominant (peak for Violet) wavelength shift vs. case temperature – C, V

Typical Chromaticity Coordinate Shift over Temperature

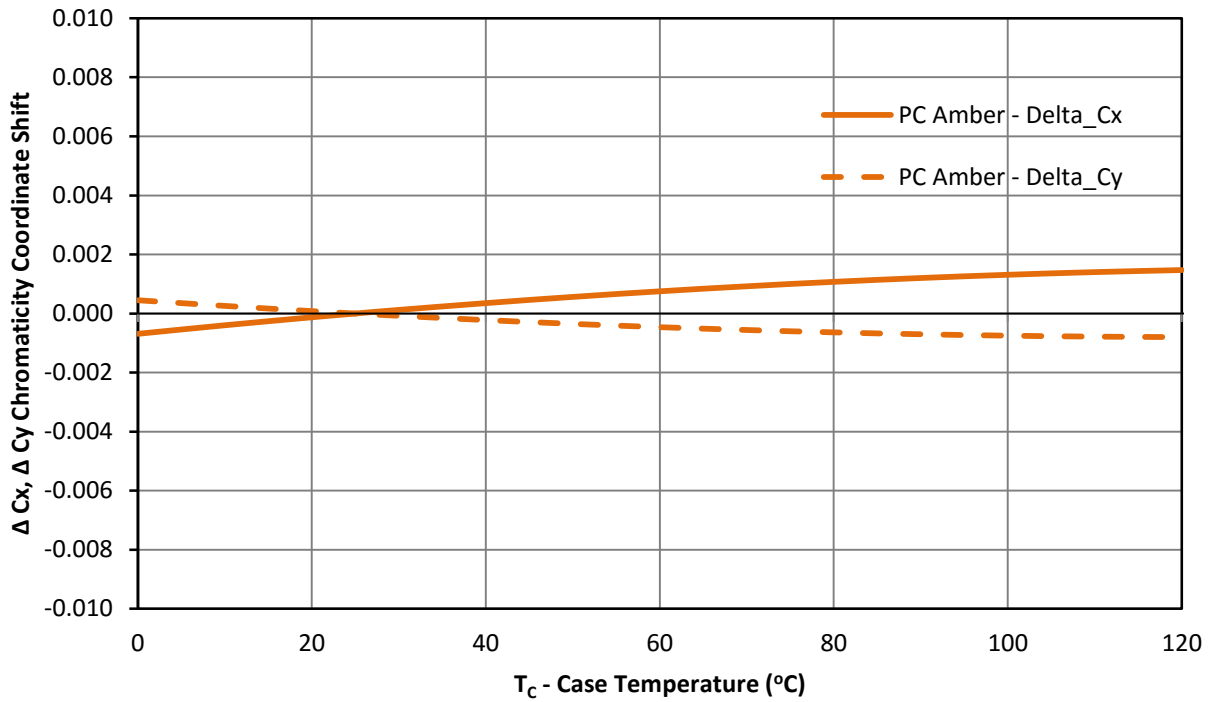

Figure 10c: Typical chromaticity coordinate shift vs. case temperature – PC Amber

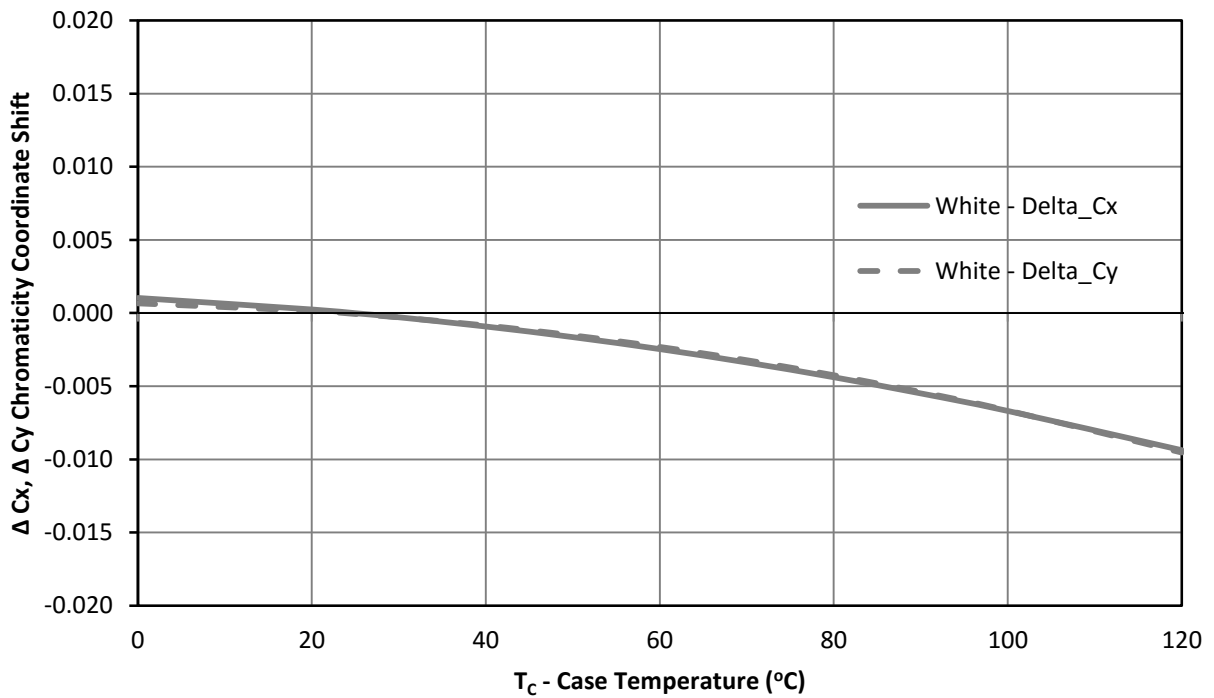

Figure 10d: Typical chromaticity coordinate shift vs. case temperature - White

Current De-rating

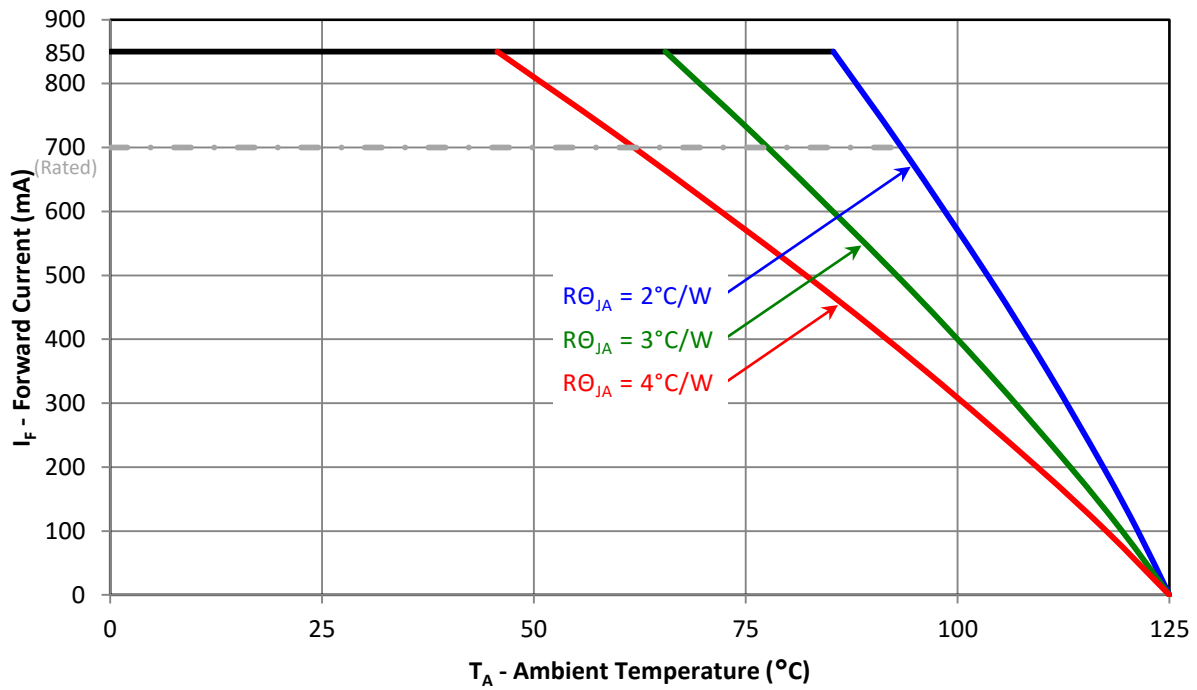

Figure 11: Maximum forward current vs. ambient temperature

Notes for Figure 11:

1. Maximum current assumes that all 7 LED die are operating concurrently at the same current.
2. $R_{\theta_{JC}}$ [Junction to Case Thermal Resistance] for LZ7-04MU00 is 1.4°C/W.
3. $R_{\theta_{JA}}$ [Junction to Ambient Thermal Resistance] = $R_{\theta_{JC}}$ + $R_{\theta_{CA}}$ [Case to Ambient Thermal Resistance].

Emitter Tape and Reel Specifications (mm)

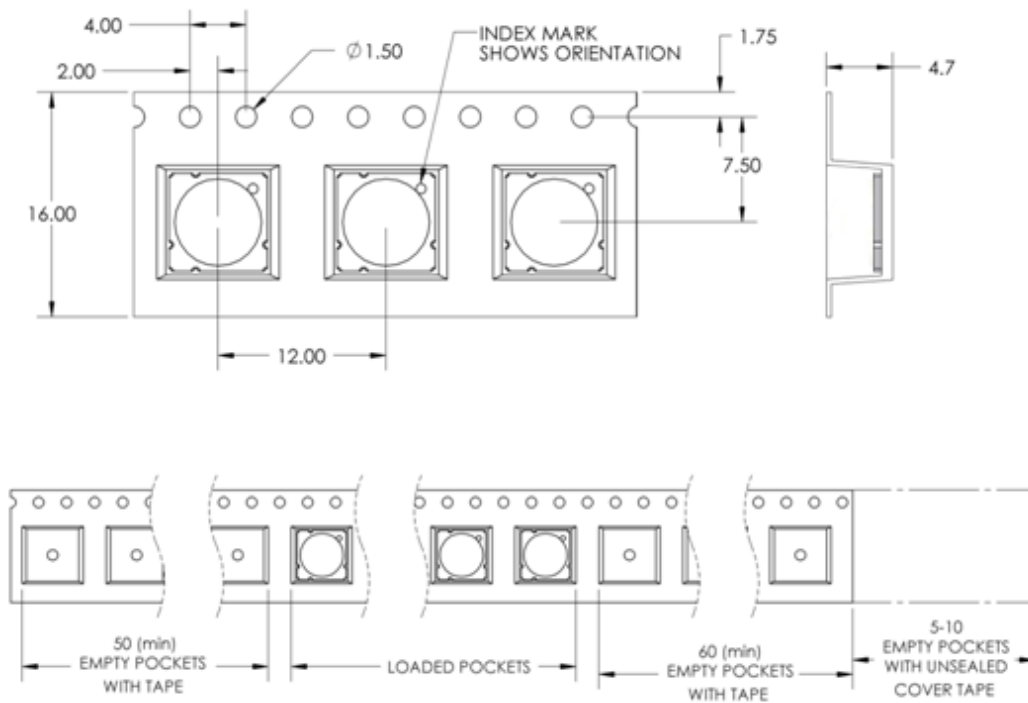

Figure 12: Emitter carrier tape specifications (mm).

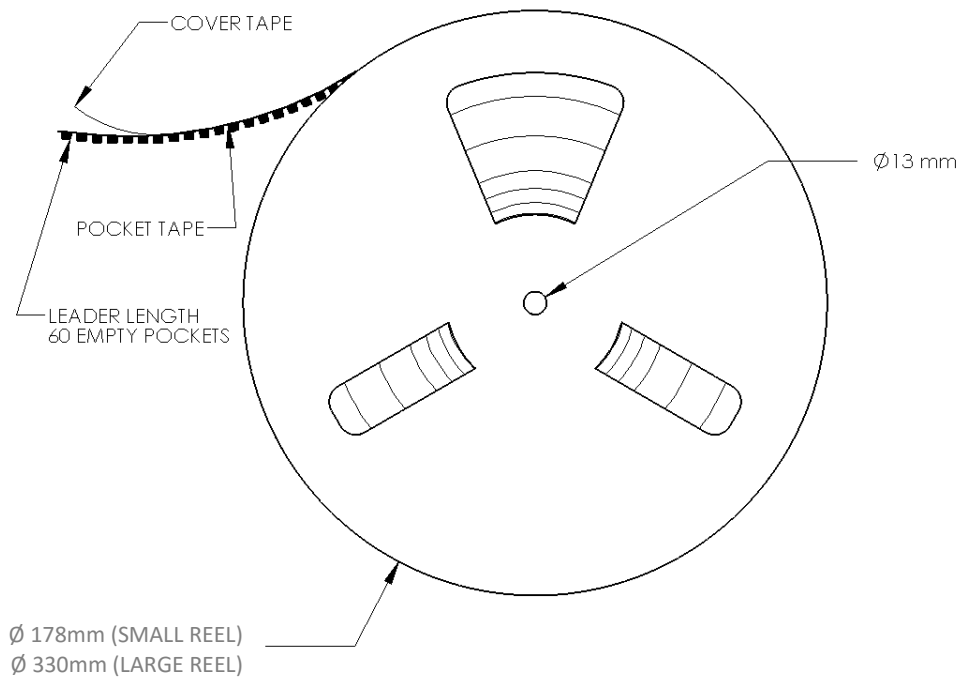

Figure 13: Emitter reel specifications (mm).

Notes for Figure 13:

1. Small reel quantity: up to 250 emitters
2. Large reel quantity: 250-1200 emitters.
3. Single flux bin and single wavelength bin per reel.

LZ7 MCPCB Family

Part number	Type of MCPCB	Dimension (mm)	Emitter + MCPCB Thermal Resistance ($^{\circ}\text{C}/\text{W}$)	Typical V_f (V)	Typical I_f (mA)
LZ7-Nxxxxxx	7-channel	38.3 x 31.2	1.4 + 0.1 = 1.5	Red: 2.5V Green: 3.6V Blue: 3.2V White: 3.2V PC-A: 3.2V Cyan: 3.6V Violet: 3.7V	700

LZ7-Nxxxxx

7 channel, MCPCB (7x1) Dimensions (mm)

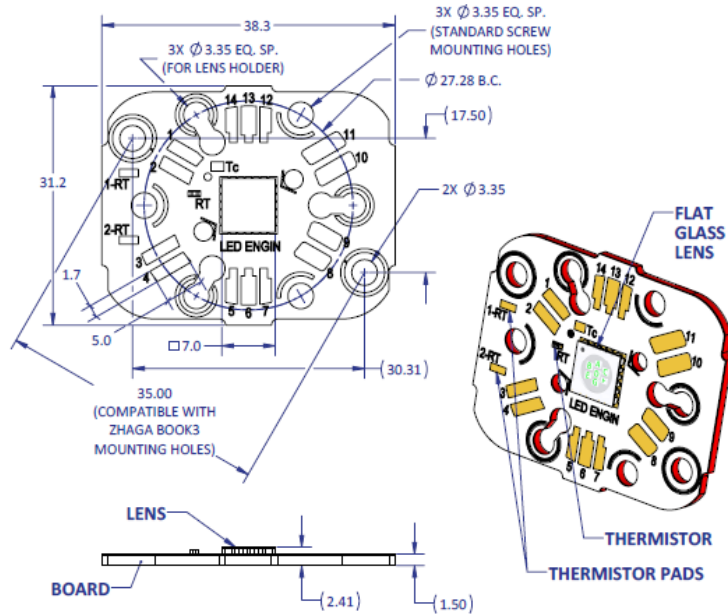

Notes:

- Unless otherwise noted, the tolerance = ± 0.2 mm.
- Standard screw refers to M3 or #4-40 screw.
- The thermal resistance of the MCPCB is: R_{ΘC-B} 0.1°C/W

Components used

MCPCB: MHE-301 copper (Rayben)
 Thermistor: NCP15XH103F03RC (Murata)

Pad layout			
Ch.	MCPCB Pad	Die/ Color	Function
1	1	B/ Red	Anode +
	14		Cathode -
2	2	A/ Green	Anode +
	13		Cathode -
3	3	C/ Blue	Anode +
	12		Cathode -
4	4	F/ PC Amber	Anode +
	11		Cathode -
5	5	E/ CW	Anode +
	10		Cathode -
6	6	G/ Cyan	Cathode -
	9		Anode +
7	7	D/ UV	Anode +
	8		Cathode -
T	1-RT	NTC	10kOhm NTC
	2-RT		

Application Guidelines

MCPCB Assembly Recommendations

A good thermal design requires an efficient heat transfer from the MCPCB to the heat sink. In order to minimize air gaps in between the MCPCB and the heat sink, it is common practice to use thermal interface materials such as thermal pastes, thermal pads, phase change materials and thermal epoxies. Each material has its pros and cons depending on the design. Thermal interface materials are most efficient when the mating surfaces of the MCPCB and the heat sink are flat and smooth. Rough and uneven surfaces may cause gaps with higher thermal resistances, increasing the overall thermal resistance of this interface. It is critical that the thermal resistance of the interface is low, allowing for an efficient heat transfer to the heat sink and keeping MCPCB temperatures low.

When optimizing the thermal performance, attention must also be paid to the amount of stress that is applied on the MCPCB. Too much stress can cause the ceramic emitter to crack. To relax some of the stress, it is advisable to use plastic washers between the screw head and the MCPCB and to follow the torque range listed below. For applications where the heat sink temperature can be above 50°C, it is recommended to use high temperature and rigid plastic washers, such as polycarbonate or glass-filled nylon.

LED Engin recommends the use of the following thermal interface materials:

1. Bergquist's Gap Pad 5000S35, 0.020in thick
 - Part Number: Gap Pad® 5000S35 0.020in/0.508mm
 - Thickness: 0.020in/0.508mm
 - Thermal conductivity: 5 W/m-K
 - Continuous use max temperature: 200°C
 - Using M3 Screw (or #4 screw), with polycarbonate or glass-filled nylon washer (#4) the recommended torque range is: 50 to 60 in-oz (3.13 to 3.75 in-lbs or 0.35 to 0.42 N-m)

2. 3M's Acrylic Interface Pad 5590H
 - Part number: 5590H @ 0.5mm
 - Thickness: 0.020in/0.508mm
 - Thermal conductivity: 3 W/m-K
 - Continuous use max temperature: 100°C
 - Using M3 Screw (or #4 screw), with polycarbonate or glass-filled nylon washer (#4) the recommended torque range is: 50 to 60 in-oz (3.13 to 3.75 in-lbs or 0.35 to 0.42 N-m)

Mechanical Mounting Considerations

The mounting of MCPCB assembly is a critical process step. Excessive mechanical stress build up in the MCPCB can cause the MCPCB to warp which can lead to emitter substrate cracking and subsequent cracking of the LED dies

LED Engin recommends the following steps to avoid mechanical stress build up in the MCPCB:

- Inspect MCPCB and heat sink for flatness and smoothness.
- Select appropriate torque for mounting screws. Screw torque depends on the MCPCB mounting method (thermal interface materials, screws, and washer).
- Always use three M3 or #4-40 screws with #4 washers.
- When fastening the three screws, it is recommended to tighten the screws in multiple small steps. This method avoids building stress by tilting the MCPCB when one screw is tightened in a single step.
- Always use plastic washers in combinations with the three screws. This avoids high point contact stress on the screw head to MCPCB interface, in case the screw is not seated perpendicular.
- In designs with non-tapped holes using self-tapping screws, it is common practice to follow a method of three turns tapping a hole clockwise, followed by half a turn anti-clockwise, until the appropriate torque is reached.

Wire Soldering

- To ease soldering wire to MCPCB process, it is advised to preheat the MCPCB on a hot plate of 125-150°C. Subsequently, apply the solder and additional heat from the solder iron will initiate a good solder reflow. It is recommended to use a solder iron of more than 60W.
- It is advised to use lead-free, no-clean solder. For example: SN-96.5 AG-3.0 CU 0.5 #58/275 from Kester (pn: 24-7068-7601)

Company Information

LED Engin, Inc., based in California’s Silicon Valley, specializes in ultra-bright, ultra compact solid state lighting solutions allowing lighting designers & engineers the freedom to create uncompromised yet energy efficient lighting experiences. The LuxiGen™ Platform — an emitter and lens combination or integrated module solution, delivers superior flexibility in light output, ranging from 3W to 90W, a wide spectrum of available colors, including whites, multi-color and UV, and the ability to deliver upwards of 5,000 high quality lumens to a target. The small size combined with powerful output allows for a previously unobtainable freedom of design wherever high-flux density, directional light is required. LED Engin’s packaging technologies lead the industry with products that feature lowest thermal resistance, highest flux density and consummate reliability, enabling compact and efficient solid state lighting solutions.

LED Engin is committed to providing products that conserve natural resources and reduce greenhouse emissions.

LED Engin reserves the right to make changes to improve performance without notice.

Please contact sales@ledengin.com or (408) 922-7200 for more information.