

LTC3884EUK High Efficiency, Dual-Output, Synchronous Buck Converter with Power System Management

DESCRIPTION

Demonstration circuit 2165A is a high efficiency, high density, dual-output buck converter with a 4.5V to 14V input range. The output voltage is adjustable from 0.5V to 5.5V, and each output can supply up to 30A of load current when the output voltage is within a 0.5V to 1.8V range. This demo board features the [LTC®3884](#), a dual-output poly phase step-down controller with ultra-low DCR sensing and incorporates digital power system management. The LTC3884 data sheet must be read in conjunction with this demo board manual for this demonstration circuit DC2165A.

The DC21065A powers up to default settings and produces power based on configuration resistors or with its non-volatile memory without the need for any serial bus communication. This allows easy evaluation of the DC/DC converter. To fully explore the extensive power system management features of the part, download the

GUI software LTpowerPlay™ onto your PC and use LTC's I²C/SMBus/PMBus dongle DC1613A to connect to the board. LTpowerPlay allows the user to reconfigure the part on-the-fly and store the configuration in EEPROM, view telemetry of voltage, current, temperature and fault status.

GUI Software LTpowerPlay Download

The software can be downloaded from:
<http://www.linear.com/LTpowerPlay>

For more details and instructions of LTpowerPlay, please refer to LTpowerPlay GUI for LTC3884 demo manual.

Design files for this circuit board are available at
<http://www.linear.com/demo/DC2165>

LT, LT, LTC, LTM, Linear Technology and the Linear logo are registered trademarks and LTpowerPlay is a trademark of Linear Technology Corporation. All other trademarks are the property of their respective owners.

PERFORMANCE SUMMARY Specifications are at T_A = 25°C

PARAMETER	CONDITIONS	VALUE
Input Voltage Range		4.5V to 14V
Output Voltages, V _{OUT0} /V _{OUT1}	V _{IN} = 4.5V to 14V, I _{OUT0} /I _{OUT1} = 0A to 30A	Default: 1V
Maximum Output Current, I _{OUT0} /I _{OUT1}	V _{IN} = 4.5V to 14V, V _{OUT0} /V _{OUT1} = 0.5V to 1.8V	30A
Typical Efficiency	V _{IN} = 12V, V _{OUT0} /V _{OUT1} = 1.0V, I _{OUT0} /I _{OUT1} = 30A	86.5%
Peak Efficiency	V _{IN} = 12V, V _{OUT0} /V _{OUT1} = 1.0V	88.8%
Default Switching Frequency		425kHz

QUICK START PROCEDURE

Demonstration circuit 2165A is easy to set up to evaluate the performance of the LTC3884. Refer to Figure 1 for the proper measurement equipment setup and follow the procedure below.

1. With power off, connect the input power supply to V_{IN} (4.5V to 14V) and GND (input return).
2. Connect the output load between V_{OUT0}/V_{OUT1} and GND (Initial load: no load).
3. Connect the DVMs to the input and outputs.
4. Check the default jumper/switch position: JP1: OFF, JP4: OFF, JP5: INT, SW1: OFF, SW2: OFF.
5. Turn on the input power supply up to 12V.

NOTE: Make sure that the input voltage does not exceed 14V.

6. Turn on the switches: SW1: ON, SW2: ON.
7. Check for the proper output voltages from V_{OUT0+} to V_{OUT0-} and V_{OUT1+} to V_{OUT1-} .

8. Once the proper output voltages are established, adjust the loads within the operating range and observe the output voltage regulation, ripple voltage and other parameters.
9. Connect the dongle and control the output voltages from the GUI. See LTpowerPlay Quick Start Guide session for details.

NOTE: When measuring the output or input voltage ripple, do not use the long ground lead on the oscilloscope probe. See Figure 2 for the proper scope probe technique. Short, stiff leads need to be soldered to the (+) and (-) terminals of an output capacitor. The probe's ground ring needs to touch the (-) lead and the probe tip needs to touch the (+) lead.

Connecting a PC to DC2165A

You can use a PC to reconfigure the power management features of the LTC3884 such as: nominal V_{OUT} , margin set points, OV/UV limits, temperature fault limits, sequencing parameters, the fault log, fault responses, GPIOs and other functionality. The DC2165A dongle may be plugged when V_{IN} is present.

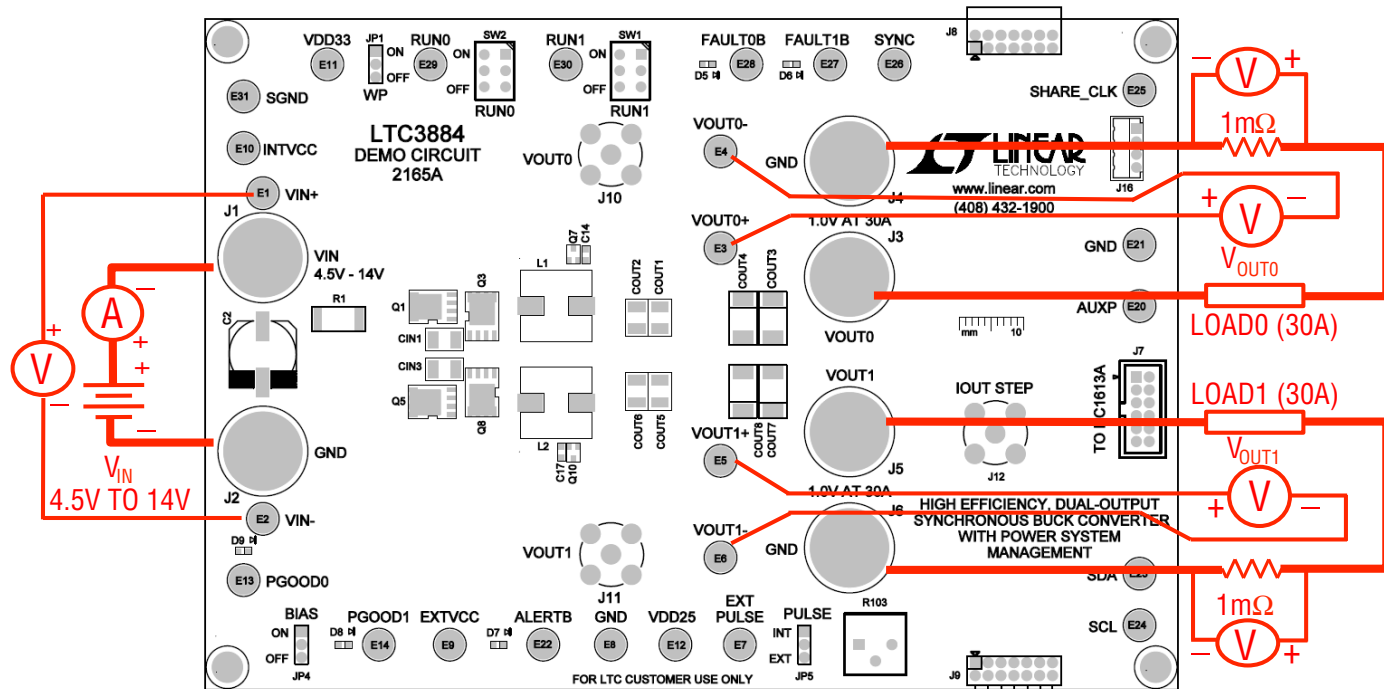

Figure 1. Proper Measurement Equipment Setup

QUICK START PROCEDURE

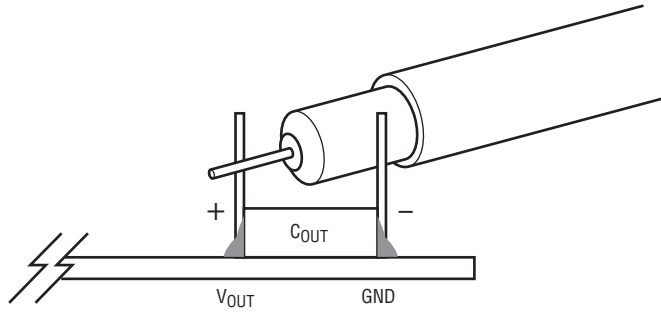

Figure 2. Measuring Output Voltage Ripple

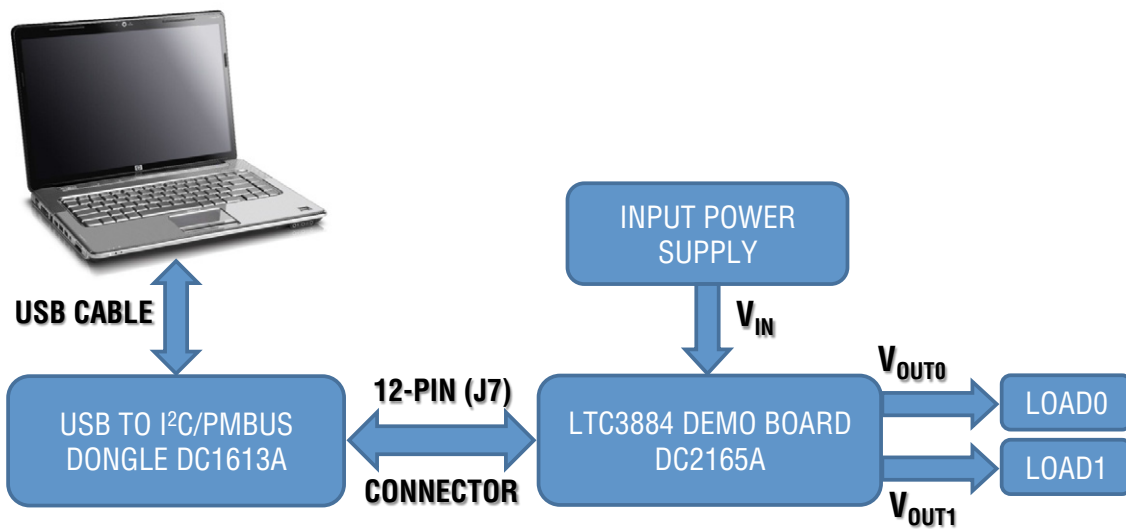

Figure 3. Demo Setup with PC

QUICK START PROCEDURE

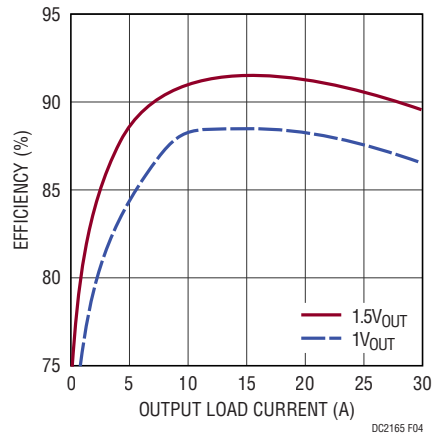

Figure 4. Efficiency vs Load Current at $V_{IN} = 12V$, $f_{SW} = 425kHz$

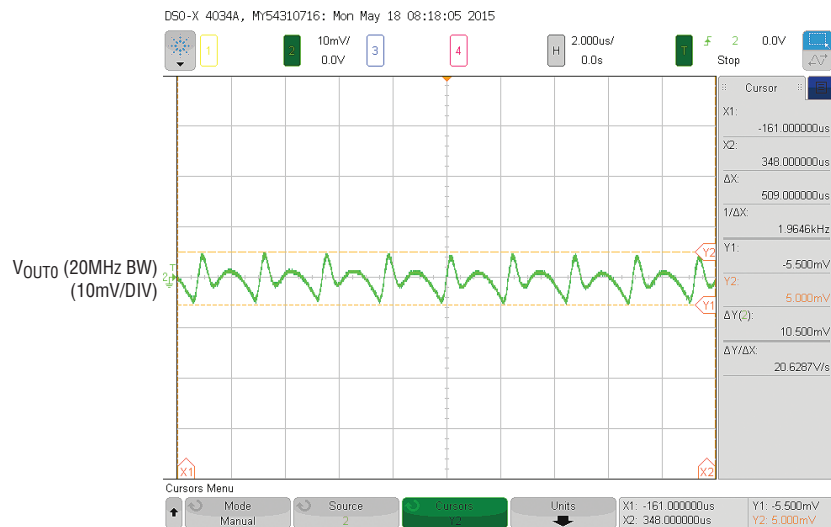

Figure 5. Output Voltage Ripple at $V_{IN} = 12V$, $V_{OUTO} = 1V$, $I_{OUTO} = 30A$

QUICK START PROCEDURE

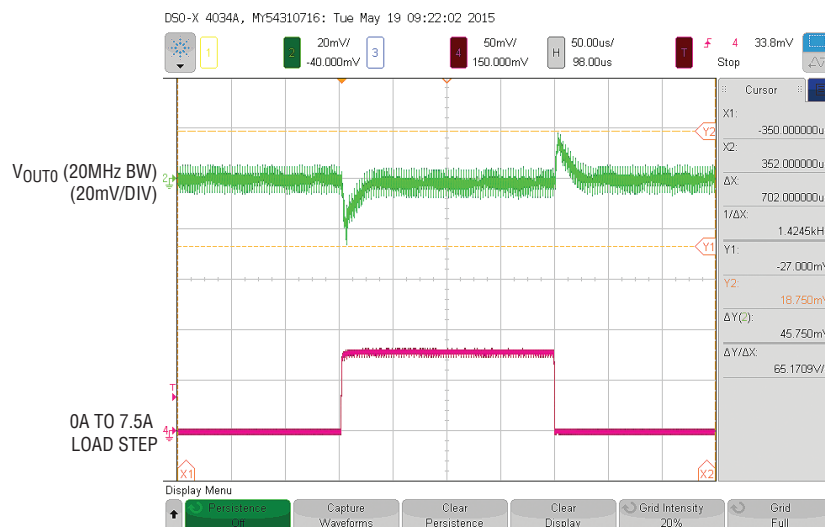

Figure 6. Transient Response at $V_{IN} = 12V$, $V_{OUTO} = 1V$, $\Delta I_{OUTO} = 7.5A$

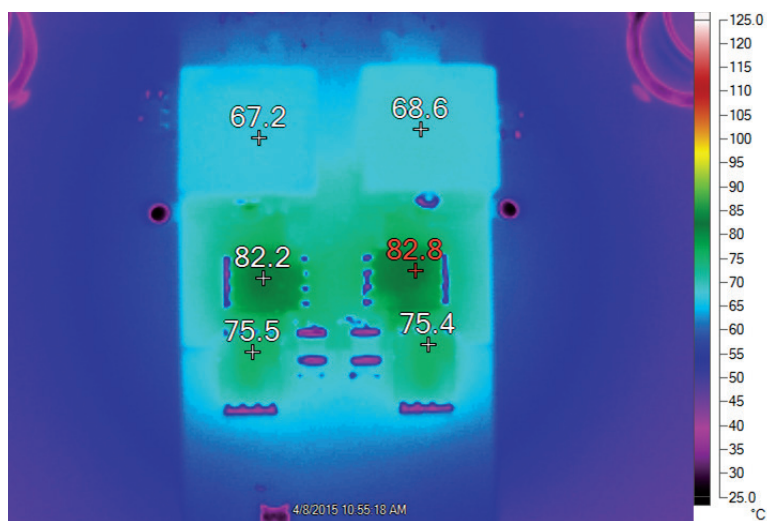

Figure 7. Thermal Performance at $V_{IN} = 12V$, $V_{OUTO} = 1.0V$, $I_{OUTO} = 30A$, $V_{OUT1} = 1.0V$, $I_{OUT1} = 30A$, $T_A = 23.6^\circ C$, No Airflow

LTpowerPlay QUICK START GUIDE

LTpowerPlay is a powerful Windows-based development environment that supports Linear Technology power system management ICs, including the LTM4676, LTC3880, LTC3883, LTC3884, LTC2974 and LTC2978. The software supports a variety of different tasks. You can use LTpowerPlay to evaluate Linear Technology ICs by connecting to a demo board system. LTpowerPlay can also be used in an offline mode (with no hardware present) in order to build a multichip configuration file that can be saved and reloaded at a later time. LTpowerPlay provides unprecedented diagnostic and debug features. It becomes a valuable diagnostic tool during board bring-up to program or tweak the power management scheme in a system, or to diagnose power issues when bringing up rails. LTpowerPlay utilizes the DC1613A USB-to-SMBus controller to communicate with one of many potential targets, including the LTM4676, the LTC3880, LTC3884

and the LTC3883's demo system, or a customer board. The software also provides an automatic update feature to keep the software current with the latest set of device drivers and documentation. The LTpowerPlay software can be downloaded from:

<http://www.linear.com/LTpowerPlay>

To access technical support documents for LTC Digital Power Products visit Help. View online help on the LTpowerPlay menu.

The following procedure describes how to use LTpowerPlay to monitor and change the settings of LTC3884.

1. Download and install the LTpowerPlay GUI:

<http://www.linear.com/LTpowerPlay>

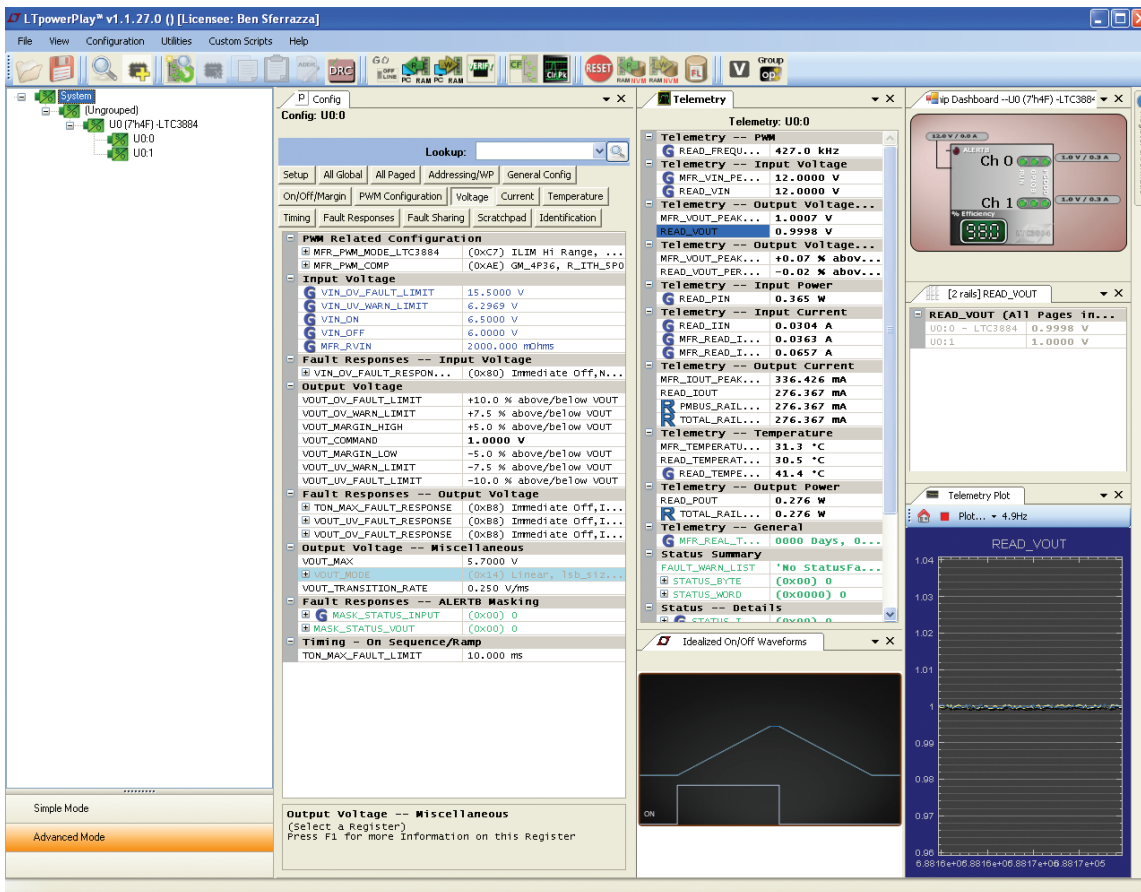
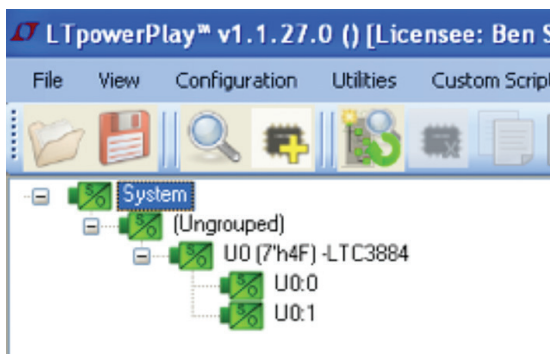

Figure 8. LTpowerPlay Main Interface

LTpowerPlay QUICK START GUIDE

2. Launch the LTpowerPlay GUI.

- a. The GUI should automatically identify the DC2165A. The system tree on the left hand side should look like this:



- b. A green message box shows for a few seconds in the lower left hand corner, confirming that LTC3884 is communicating:

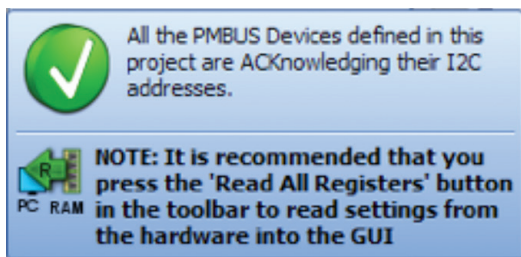

- c. In the Toolbar, click the “R” (RAM to PC) icon to read the RAM from the LTC3884. This reads the configuration from the RAM of LTC3884 and loads it into the GUI.



- d. If you want to change the output voltage to a different value, like 1.5V. In the Config tab, type in 1.5 in the VOUT_COMMAND box, like this:

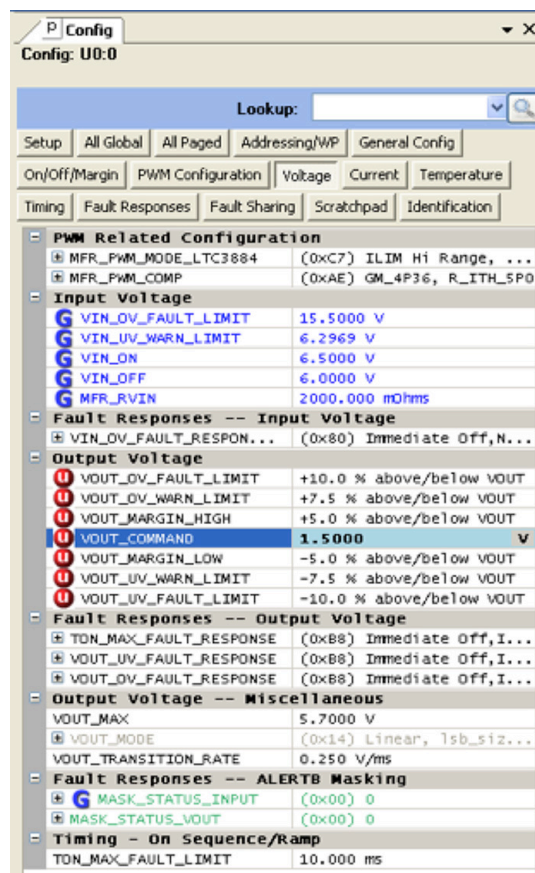

Then, click the “W” (PC to RAM) icon to write these register values to the LTC3884. After finishing this step, you will see the output voltage will change to 1.5V.



DEMO MANUAL DC2165A

LTpowerPlay QUICK START GUIDE

If the write is successful, you will see the following message:

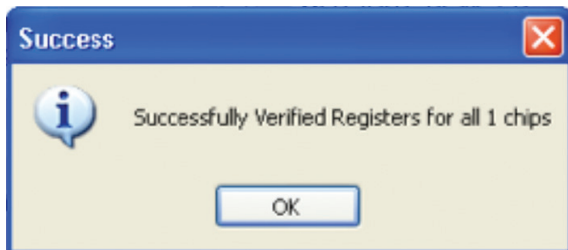

e. You can save the changes into the NVM. In the tool bar, click “RAM to NVM” button, as following:



f. Save the demo board configuration to a (*.proj) file. Click the Save icon and save the file with a preferred file name.

PARTS LIST

ITEM	QTY	REFERENCE	PART DESCRIPTION	MANUFACTURER/PART NUMBER
Required Circuit Components				
1	4	CIN1, CIN2, CIN3, CIN4	CAP, 1210 10µF 20% 35V X5R	AVX 1210DD106MAT2A
2	10	COUT1, COUT2, COUT5, COUT6, COUT19, COUT20, COUT24, COUT25, C34, C35	CAP, 1210 100µF 20% 6.3V X5R	AVX 12106D107MAT2A
3	8	COUT3, COUT4, COUT7, COUT8, COUT17, COUT18, COUT22, COUT23	CAP, 7343 330µF 20% 6.3V POSCAP	PANASONIC 6TPF330M9L
4	5	C7, COUT21, COUT26, C41, C42	CAP, 0603 1µF 20% 25V X5R	AVX 06033D105MAT2A
5	1	C1	CAP, 0603 2.2µF 20% 6.3V X5R	AVX 06036D225MAT2A
6	2	C2, C32	CAP, 270µF 20% 16V OSCON	PANASONIC 16SVPC270M
7	1	C3	CAP, 0805 1µF 10% 16V X7R	AVX 0805YC105KAT2A
8	1	C4	CAP, 0603 4.7µF 10% 10V X5R	AVX 0603ZD475KAT2A
0	1	C6	CAP, 0603 4.7µF 20% 25V X5R	TDK C1608X5R1E475M080AC
10	2	C8, C15	CAP, 0603 0.1µF 10% 25V X7R	AVX 06033C104KAT2A
11	2	C9, C16	CAP, 0603 220nF 10% 25V X7R	TDK C1608X7R1E224K
12	3	C10, C12, C40	CAP, 0603 150pF 5% 50V NPO	AVX 06035A151JAT2A
13	2	C11, C13	CAP, 0603 1500pF 5% 50V C0G	MURATA GRM1885C1H152JA01D
14	4	C14, C17, C27, C28	CAP, 0603 10nF 10% 25V X7R	AVX 06033C103KAT2A
15	2	C26, C39	CAP, 0603 100nF 20% 16V X7R	AVX 0603YC104MAT2A
16	2	C30, C31	CAP, 1210 10µF 10% 16V X7R	MURATA GRM32DR71C106KA01
17	2	D1, D2	DIODE, SCHOTTKY 30V, 100mA	CENTRAL SEMI CMDSH-3-TR
18	4	D5, D6, D8, D9	LED, 0603 GREEN	WURTH ELEKTRONIK 150060GS75000
19	1	D7	LED, 0603 RED	WURTH ELEKTRONIK 150060SS75000
20	1	D12	DIODE, ULTRA LOW SCHOTTKY RECTIFIER	NXP SEMI. PMEG2005AEL, 315
21	2	L1, L2	IND, 0.25µH	WURTH ELEKTRONIK 744301025

PARTS LIST

ITEM	QTY	REFERENCE	PART DESCRIPTION	MANUFACTURER/PART NUMBER
22	2	Q1, Q5	XSTR, POWER MOSFET	INFINEON BSC050NE2LS
23	2	Q3, Q8	XSTR, POWER MOSFET	INFINEON BSC010NE2LSI
24	2	Q7, Q10	XSTR, PNP GENERAL PURPOSE	DIODES INC. MMST3906-7-F
25	2	Q19, Q20	XSTR, N-CHANNEL DMOS FET	DIODES INC. DMP3130L-7
26	4	Q21, Q22, Q25, Q26	XSTR, N-CHANNEL DMOS FET	DIODES INC 2N7002A-7
27	2	Q23, Q24	XSTR, MOSFET, N-CHANNEL 30V	VISHAY SUD50N04-8M8P-4GE3
28	1	R1	RES, 2512 0.005Ω 1% 1W	SUSUMU KRL3264E-C-R005-F-T5
29	1	R2	RES, 0603 1Ω 1% 1/10W	VISHAY CRCW06031R00FKEA
30	10	R3, R4, R15, R19, R63, R65, R66, R91, R113, R114	RES, 0603 0Ω JUMPER	VISHAY CRCW06030000Z0EA
31	4	R5, R16, R18, R21	RES, 0603 10Ω 1% 1/10W	VISHAY CRCW060310R0FKEA
32	12	R6, R7, R8, R10, R29, R30, R33, R34, R77, R87, R98, R105	RES, 0603 10kΩ 5% 1/10W	VISHAY CRCW060310K0JNEA
33	6	R9, R11, R12, R13, R72, R73	RES, 0603 4.99kΩ 1% 1/10W	VISHAY CRCW06034K99FKEA
34	2	R14, R20	RES, 0603 715Ω 1% 1/10W	VISHAY CRCW0603715RFKEA
35	2	R69, R70	RES, 0603 10Ω 5% 1/10W	VISHAY CRCW060310R0JNEA
36	1	R78	RES, 0603 15.8kΩ 1% 1/10W	VISHAY CRCW060315K8FKEA
37	4	R79, R80, R125, R130	RES, 0603 200Ω 5% 1/10W	VISHAY CRCW0603200RJNEA
38	1	R81	RES, 0603 127Ω 1% 1/10W	VISHAY CRCW0603127RFKEA
39	1	R89	RES, 0603 2Ω 5% 1/10W	VISHAY CRCW06032R00JNEA
40	1	R90	RES, 2010 0Ω JUMPER	VISHAY CRCW20100000Z0EA
41	1	R92	RES, 0603 3.3Ω 1% 1/10W	VISHAY CRCW06033R30FKEA
42	1	R93	RES, 0603 154kΩ 1% 1/10W	VISHAY CRCW0603154KFKEA
43	1	R94	RES, 0603 1MΩ 5% 1/10W	VISHAY CRCW06031M00JNEA
44	2	R95, R96	RES, 0603 20kΩ 5% 1/10W	VISHAY CRCW060320K0JNEA
45	1	R97	RES, 0603 681kΩ 1% 1/10W	VISHAY CRCW0603681KFKEA
46	1	R99	RES, 0603 182Ω 1% 1/10W	VISHAY CRCW0603182RFKEA
47	1	R100	RES, 0603 82.5Ω 1% 1/10W	VISHAY CRCW060382R5FKEA
48	1	R101	RES, 2512 0.01Ω 1% 1W	VISHAY WSL2512R0100FEA
49	1	R103	RES, VARIABLE 5kΩ	BOURNS 3386P-1-502-LF
50	1	R104	RES, 0603 649Ω 1% 1/10W	VISHAY CRCW0603649RFKEA
51	1	R107	RES, 0603 34.8kΩ 1% 1/10W	VISHAY CRCW060334K8FKEA
52	2	SW1, SW2	SWITCH, SUBMINIATURE SLIDE	C&K JS202011CQN
53	1	U1	IC, LTC3884	LINEAR TECH. LTC3884EUK#10E1-1PBF-ES
54	1	U3	IC, 24LC05-I/ST	MICROCHIP 24LC025-I/ST
55	1	U4	IC, REGULATOR	LINEAR TECH. LT1761ES5-SD#PBF
56	1	U5	IC, LTC6992	LINEAR TECH. LTC6992IS6-1#PBF
57	1	U6	IC, SINGLE OP AMP	LINEAR TECH. LT1803IS5#PBF

DEMO MANUAL DC2165A

PARTS LIST

ITEM	QTY	REFERENCE	PART DESCRIPTION	MANUFACTURER/PART NUMBER
Additional Demo Board Circuit Components				
1	0	C5	CAP, 0603 OPTION	OPTION
2	0	D10, D11	DIODE, SCHOTTKY 30V, 100mA OPTION	CENTRAL SEMI CMDSH-3-TR OPTION
3	0	Q2, Q4, Q6, Q9	XSTR, POWER MOSFET OPTION	OPTION
4	0	R17, R22, R23, R24, R25, R26, R27, R28, R31, R32, R35, R36, R37, R38, R39, R40, R42, R43, R45, R46, R61, R62, R64, R67, R68, R74, R75, R106, R126, R139, R142, R146, R147	RES, 0603 OPTION	OPTION
5	0	R41, R44, R47, R48, R85, R86, R88	RES, 2010 OPTION	OPTION
6	0	R102	RES, 2512 OPTION	OPTION
Hardware				
1	26	E1, E2, E3, E4, E5, E6, E7, E8, E9, E10, E11, E12, E13, E14, E20, E21, E22, E23, E24, E25, E26, E27, E28, E29, E30, E31	TURRET	MILL MAX 2501-2-00-80-00-00-07-0
2	3	JP1, JP4, JP5	HEADER, SINGLE ROW 3-PIN	WURTH ELEKTRONIK 62000311131
3	6	J1, J2, J3, J4, J5, J6	STUD, TEST PIN	PEM KFH-032-10
4	1	J7	HEADER, 12-PIN 2mm STR DL	FCI 98414-G06-12ULF
5	1	J8	CONN, SOCKET 14-PIN DUAL ROW R/A	SULLINS INC. NPPN072FJFN-RC
6	1	J9	HEADER, 14-PIN DUAL ROW R/A	MOLEX 87760-1416
7	3	J10, J11, J12	CONN, BNC, 5 PINS	AMPHENOL CONNEX 112404
8	1	J16	HEADER, 4-PIN 2mm STR DL	HIROSE DF3A-4P-2DSA
9	7		LUG RING, #10	KEYSTONE 8205
10	14		NUT, BRASS 10-32	ANY #10-32
11	7		WASHER, #10 TIN PLATED BRASS	ANY #10 EXT BZ TN
12	4	MH1, MH2, MH3, MH4	STANDOFF, SNAP ON	KEYSTONE 8834
13	3	XJP1, XJP4, XJP5	SHUNT	WURTH ELEKTRONIK, 60800213421

SCHEMATIC DIAGRAM

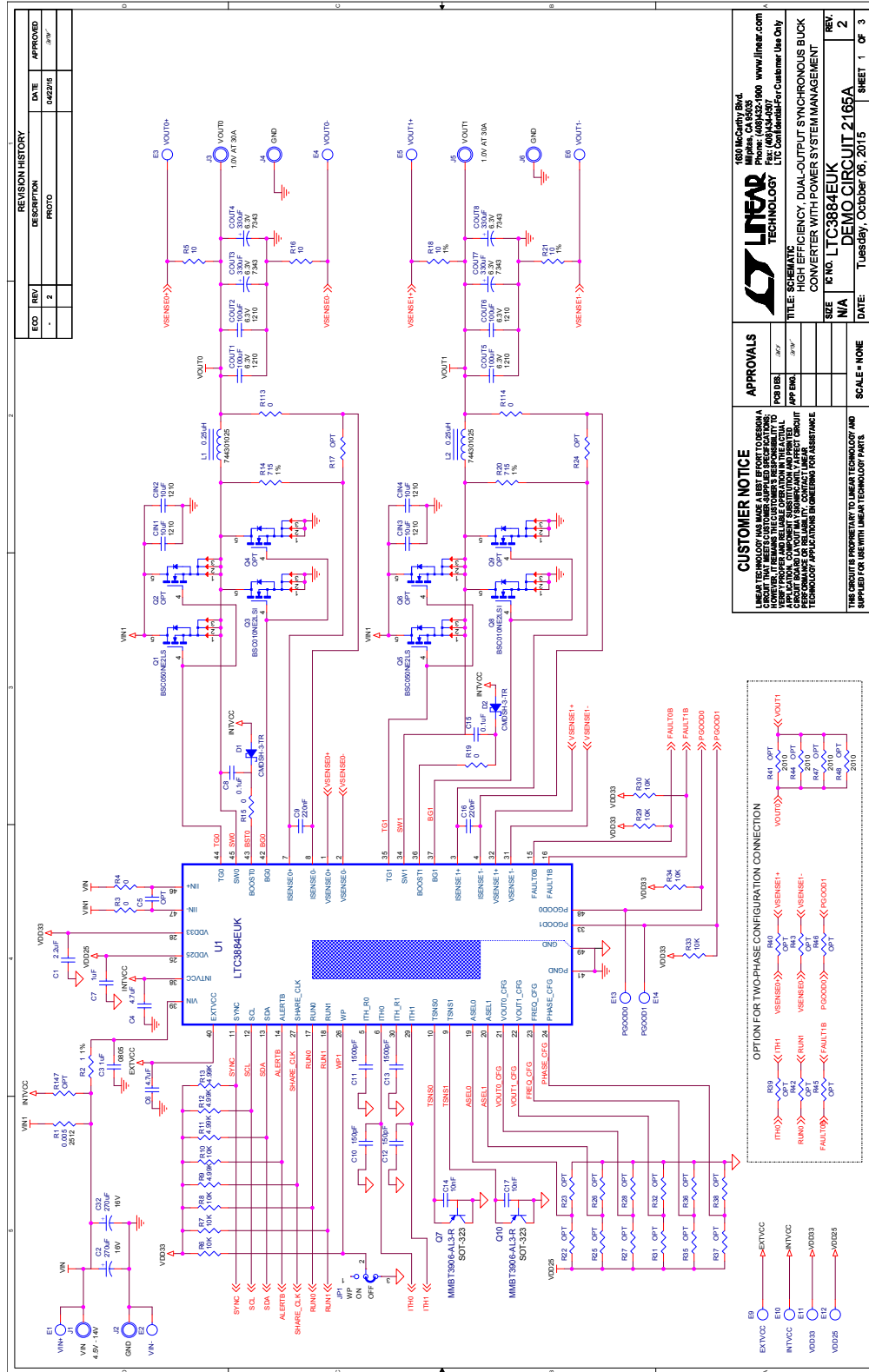

SCHEMATIC DIAGRAM

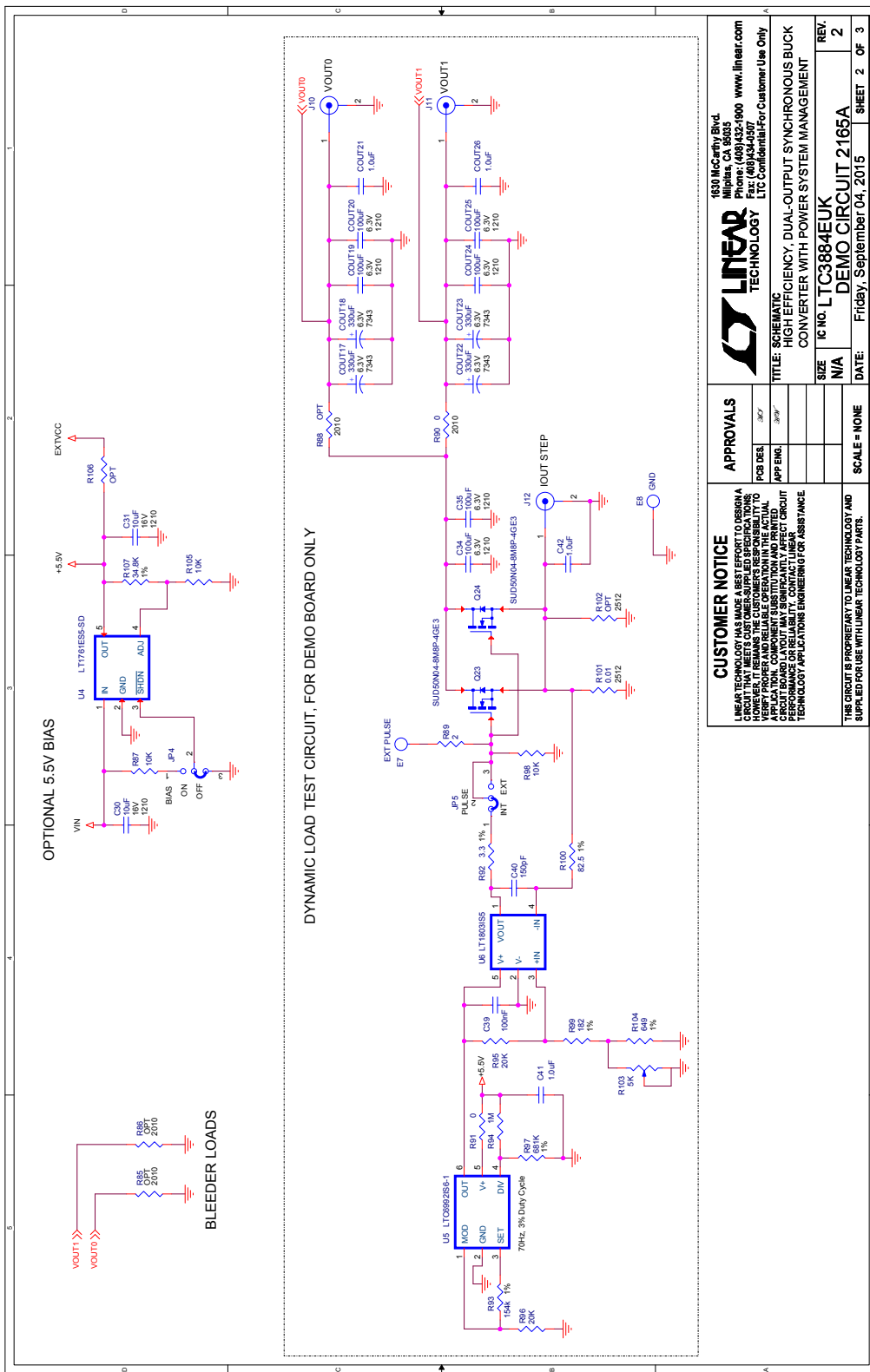

SCHEMATIC DIAGRAM

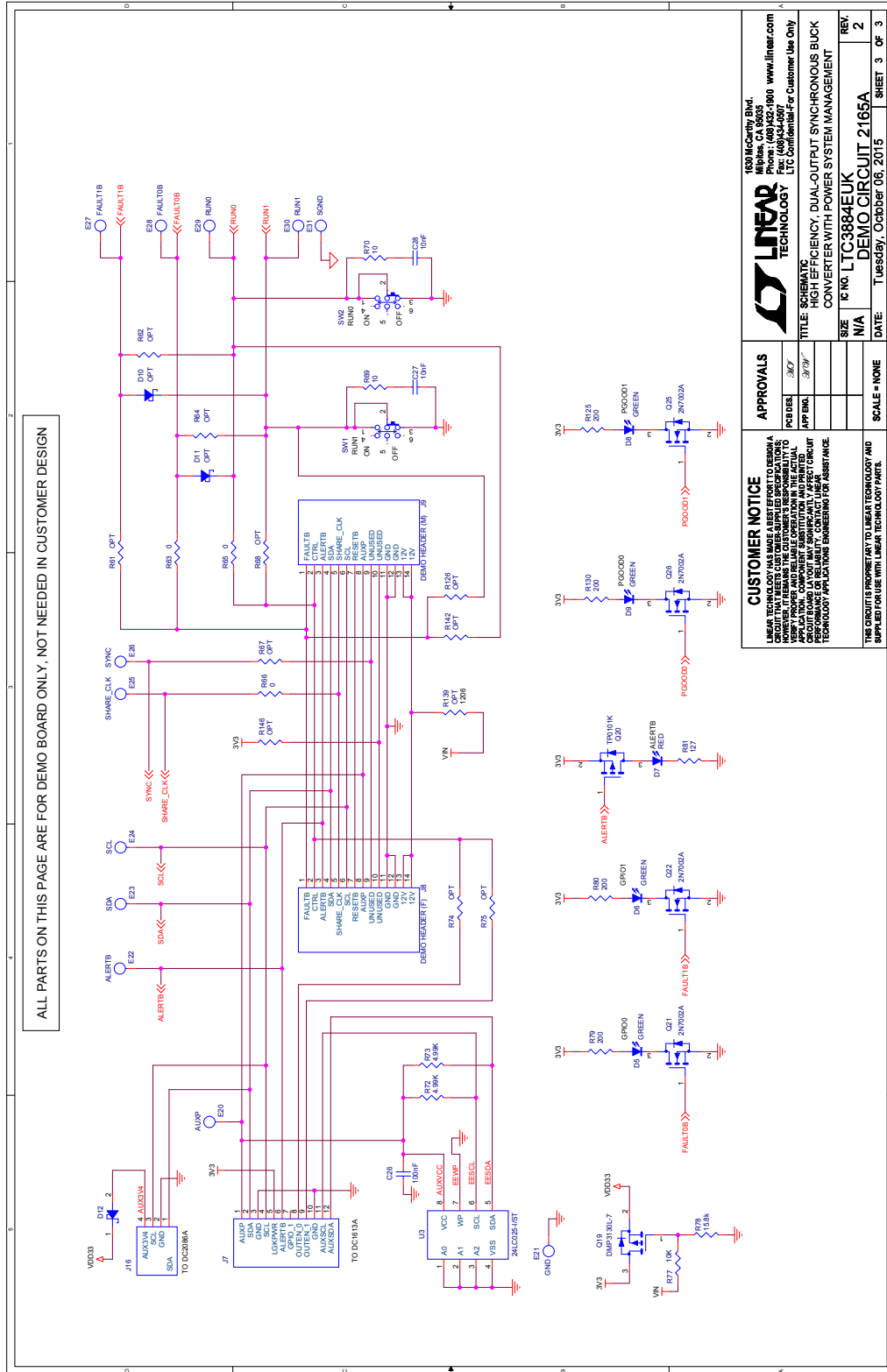

CUSTOMER NOTICE
 LINEAR TECHNOLOGY HAS MADE A BEST EFFORT TO DESIGN A SCHEMATIC FOR THE CUSTOMER'S REFERENCE. HOWEVER, IT REMAINS THE CUSTOMER'S RESPONSIBILITY TO VERIFY ALL PINS AND RELIABLE OPERATION IN THE FINAL CUSTOMER DESIGN. LINEAR TECHNOLOGY ACCEPTS NO LIABILITY FOR THE CIRCUIT BOARD LAYOUT, MOUNTING, OR ANY OTHER ASPECT OF THE CUSTOMER'S DESIGN. LINEAR TECHNOLOGY ENGINEERING FOR ASSISTANCE.

APPROVALS

DESIGNER	3807
APP'D	3799

LINEAR TECHNOLOGY
 1000 Lakeside Drive
 Milpitas, CA 95035
 Phone: (408) 932-1600 www.linear.com
 Fax: (408) 932-4507
 LTC Confidential-For Customer Use Only

TITLE: SCHEMATICS
CONVERTER WITH POWER SYSTEM MANAGEMENT
SIZE: 16 NO. LTC3884EUK
DEM0 CIRCUIT 2165A
REV: 2

SCALE: NONE

DATE: Tuesday, October 06, 2015
SHEET 3 OF 3

DEMO MANUAL DC2165A

DEMONSTRATION BOARD IMPORTANT NOTICE

Linear Technology Corporation (LTC) provides the enclosed product(s) under the following **AS IS** conditions:

This demonstration board (DEMO BOARD) kit being sold or provided by Linear Technology is intended for use for **ENGINEERING DEVELOPMENT OR EVALUATION PURPOSES ONLY** and is not provided by LTC for commercial use. As such, the DEMO BOARD herein may not be complete in terms of required design-, marketing-, and/or manufacturing-related protective considerations, including but not limited to product safety measures typically found in finished commercial goods. As a prototype, this product does not fall within the scope of the European Union directive on electromagnetic compatibility and therefore may or may not meet the technical requirements of the directive, or other regulations.

If this evaluation kit does not meet the specifications recited in the DEMO BOARD manual the kit may be returned within 30 days from the date of delivery for a full refund. **THE FOREGOING WARRANTY IS THE EXCLUSIVE WARRANTY MADE BY THE SELLER TO BUYER AND IS IN LIEU OF ALL OTHER WARRANTIES, EXPRESSED, IMPLIED, OR STATUTORY, INCLUDING ANY WARRANTY OF MERCHANTABILITY OR FITNESS FOR ANY PARTICULAR PURPOSE. EXCEPT TO THE EXTENT OF THIS INDEMNITY, NEITHER PARTY SHALL BE LIABLE TO THE OTHER FOR ANY INDIRECT, SPECIAL, INCIDENTAL, OR CONSEQUENTIAL DAMAGES.**

The user assumes all responsibility and liability for proper and safe handling of the goods. Further, the user releases LTC from all claims arising from the handling or use of the goods. Due to the open construction of the product, it is the user's responsibility to take any and all appropriate precautions with regard to electrostatic discharge. Also be aware that the products herein may not be regulatory compliant or agency certified (FCC, UL, CE, etc.).

No License is granted under any patent right or other intellectual property whatsoever. **LTC assumes no liability for applications assistance, customer product design, software performance, or infringement of patents or any other intellectual property rights of any kind.**

LTC currently services a variety of customers for products around the world, and therefore this transaction **is not exclusive**.

Please read the DEMO BOARD manual prior to handling the product. Persons handling this product must have electronics training and observe good laboratory practice standards. **Common sense is encouraged.**

This notice contains important safety information about temperatures and voltages. For further safety concerns, please contact a LTC application engineer.

Mailing Address:

Linear Technology
1630 McCarthy Blvd.
Milpitas, CA 95035

Copyright © 2004, Linear Technology Corporation