

PC-Board layout  
view component side

Contact length

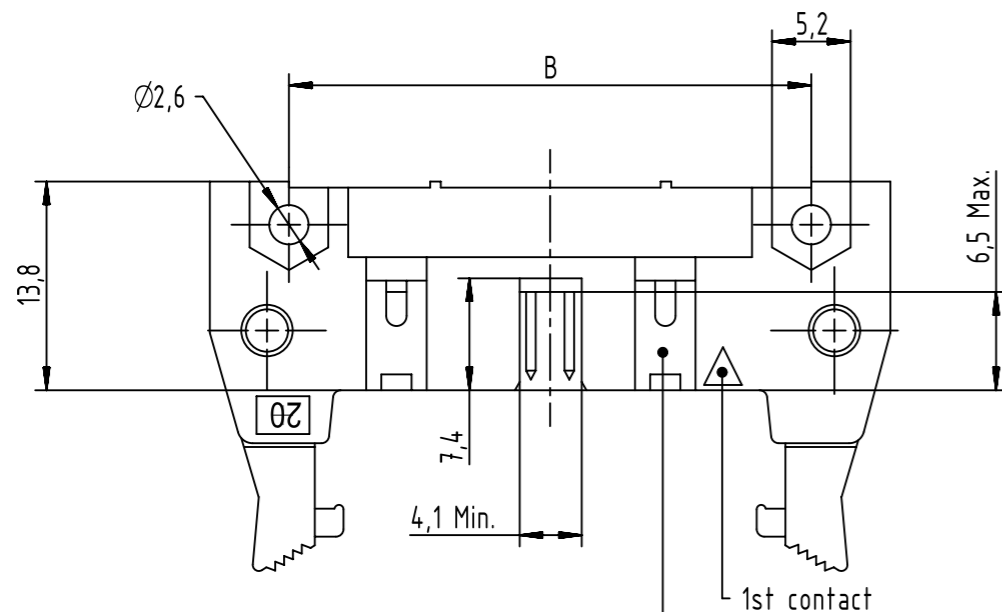
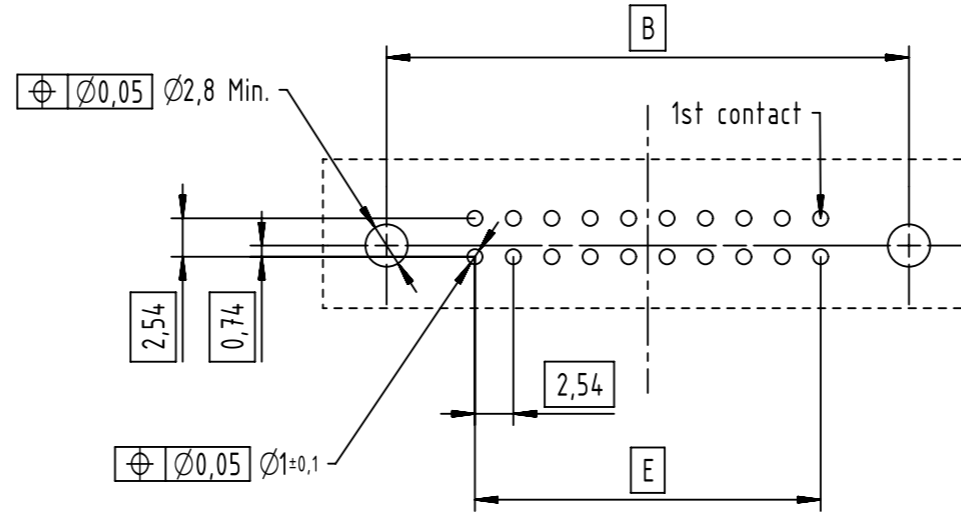
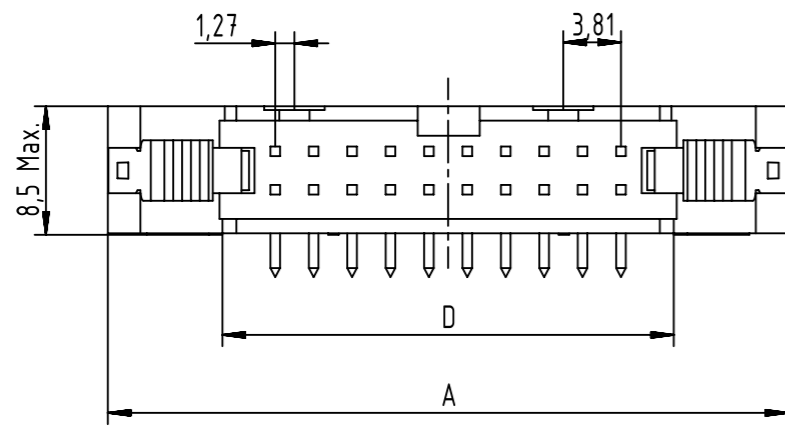

See tables for coding  
feature arrangement and style

Coding style table

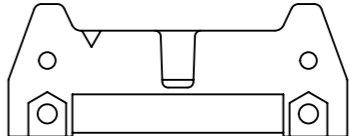
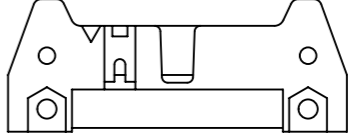
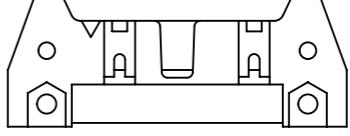
	Style A: For connectors 6 poles
	Style B: For connectors from 10 to 14 poles
	Style C: For connectors from 16 to 64 poles

Find further technical information on drawing DS 09181200001

	All rights reserved Department EC PD - FR	All Dimensions in mm Original Size DIN A3	Scale 2:1	Free size tol.	Ref. Sub.
	HARTING Electronics GmbH D-32339 Espelkamp	Created by DOUGE	Inspected by BAGDIKIAN	Standardisation HOFFMANN	Date 2013-11-07
Title SEK 18 male STD angled with long levers					State Final Release
Type TB		Number 09185XXX90X			Doc-Key / ECM-Nr. 100553395/UGD/001/A 50000067148
				Rev. A	Page 1/2

Nb of Contacts	Performance Level			Insulator Color	Contact Length ±0,3(mm)	Dimensions (mm)				
	PL3 : 50 mating Cycles No Gas Test	PL2 : 250 mating Cycles 4 days Gas Test	S4 : 0,76µm Au or equivalent PdNi			A Max	B	D	E	G
	Part Number	Part Number	Part Number							
06	0918 506 7903	0918 506 6903	0918 506 5903	Grey	2,9	27,2	16,76	12,45	2,54 x 2 = 5,08	40,3
10	0918 510 7903	0918 510 6903	0918 510 5903			32,3	21,84	17,53	2,54 x 4 = 10,16	45,4
14	0918 514 7903	0918 514 6903	0918 514 5903			37,4	26,92	22,61	2,54 x 6 = 15,24	50,4
16	0918 516 7903	0918 516 6903	0918 516 5903			39,9	29,46	25,15	2,54 x 7 = 17,78	53,0
20	0918 520 7903	0918 520 6903	0918 520 5903			45,0	34,54	30,23	2,54 x 9 = 22,86	58,1
24	0918 524 7903	0918 524 6903	0918 524 5903			50,1	39,62	35,91	2,54 x 11 = 27,94	63,2
26	0918 526 7903	0918 526 6903	0918 526 5903			52,6	42,16	37,85	2,54 x 12 = 30,48	65,7
30	0918 530 7903	0918 530 6903	0918 530 5903			58,0	47,24	43,83	2,54 x 14 = 35,56	68,6
34	0918 534 7903	0918 534 6903	0918 534 5903			62,8	52,32	48,01	2,54 x 16 = 40,64	75,8
40	0918 540 7903	0918 540 6903	0918 540 5903			70,4	59,94	55,63	2,54 x 19 = 48,26	83,5
50	0918 550 7903	0918 550 6903	0918 550 5903			83,1	72,64	68,33	2,54 x 24 = 60,96	96,2
60	0918 560 7903	0918 560 6903	0918 560 5903			95,8	85,34	81,03	2,54 x 29 = 73,66	108,9
64	0918 564 7903	0918 564 6903	0918 564 5903			100,9	90,42	86,11	2,54 x 31 = 78,74	113,9
06	0918 506 7903 001	0918 506 6903 001	0918 506 5903 001			Black	2,9	27,2	16,76	12,45
10	0918 510 7903 001	0918 510 6903 001	0918 510 5903 001	32,3	21,84			17,53	2,54 x 4 = 10,16	45,4
14	0918 514 7903 001	0918 514 6903 001	0918 514 5903 001	37,4	26,92			22,61	2,54 x 6 = 15,24	50,4
16	0918 516 7903 001	0918 516 6903 001	0918 516 5903 001	39,9	29,46			25,15	2,54 x 7 = 17,78	53,0
20	0918 520 7903 001	0918 520 6903 001	0918 520 5903 001	45,0	34,54			30,23	2,54 x 9 = 22,86	58,1
24	0918 524 7903 001	0918 524 6903 001	0918 524 5903 001	50,1	39,62			35,91	2,54 x 11 = 27,94	63,2
26	0918 526 7903 001	0918 526 6903 001	0918 526 5903 001	52,6	42,16			37,85	2,54 x 12 = 30,48	65,7
30	0918 530 7903 001	0918 530 6903 001	0918 530 5903 001	58,0	47,24			43,83	2,54 x 14 = 35,56	68,6
34	0918 534 7903 001	0918 534 6903 001	0918 534 5903 001	62,8	52,32			48,01	2,54 x 16 = 40,64	75,8
40	0918 540 7903 001	0918 540 6903 001	0918 540 5903 001	70,4	59,94			55,63	2,54 x 19 = 48,26	83,5
50	0918 550 7903 001	0918 550 6903 001	0918 550 5903 001	83,1	72,64			68,33	2,54 x 24 = 60,96	96,2
60	0918 560 7903 001	0918 560 6903 001	0918 560 5903 001	95,8	85,34			81,03	2,54 x 29 = 73,66	108,9
64	0918 564 7903 001	0918 564 6903 001	0918 564 5903 001	100,9	90,42			86,11	2,54 x 31 = 78,74	113,9
06	0918 506 7901	0918 506 6901	0918 506 5901	Grey	4,5			27,2	16,76	12,45
10	0918 510 7901	0918 510 6901	0918 510 5901			32,3	21,84	17,53	2,54 x 4 = 10,16	45,4
14	0918 514 7901	0918 514 6901	0918 514 5901			37,4	26,92	22,61	2,54 x 6 = 15,24	50,4
16	0918 516 7901	0918 516 6901	0918 516 5901			39,9	29,46	25,15	2,54 x 7 = 17,78	53,0
20	0918 520 7901	0918 520 6901	0918 520 5901			45,0	34,54	30,23	2,54 x 9 = 22,86	58,1
24	0918 524 7901	0918 524 6901	0918 524 5901			50,1	39,62	35,91	2,54 x 11 = 27,94	63,2
26	0918 526 7901	0918 526 6901	0918 526 5901			52,6	42,16	37,85	2,54 x 12 = 30,48	65,7
30	0918 530 7901	0918 530 6901	0918 530 5901			58,0	47,24	43,83	2,54 x 14 = 35,56	68,6
34	0918 534 7901	0918 534 6901	0918 534 5901			62,8	52,32	48,01	2,54 x 16 = 40,64	75,8
40	0918 540 7901	0918 540 6901	0918 540 5901			70,4	59,94	55,63	2,54 x 19 = 48,26	83,5
50	0918 550 7901	0918 550 6901	0918 550 5901			83,1	72,64	68,33	2,54 x 24 = 60,96	96,2
60	0918 560 7901	0918 560 6901	0918 560 5901			95,8	85,34	81,03	2,54 x 29 = 73,66	108,9
64	0918 564 7901	0918 564 6901	0918 564 5901			100,9	90,42	86,11	2,54 x 31 = 78,74	113,9
06	0918 506 7901 001	0918 506 6901 001	0918 506 5901 001			Black	4,5	27,2	16,76	12,45
10	0918 510 7901 001	0918 510 6901 001	0918 510 5901 001	32,3	21,84			17,53	2,54 x 4 = 10,16	45,4
14	0918 514 7901 001	0918 514 6901 001	0918 514 5901 001	37,4	26,92			22,61	2,54 x 6 = 15,24	50,4
16	0918 516 7901 001	0918 516 6901 001	0918 516 5901 001	39,9	29,46			25,15	2,54 x 7 = 17,78	53,0
20	0918 520 7901 001	0918 520 6901 001	0918 520 5901 001	45,0	34,54			30,23	2,54 x 9 = 22,86	58,1
24	0918 524 7901 001	0918 524 6901 001	0918 524 5901 001	50,1	39,62			35,91	2,54 x 11 = 27,94	63,2
26	0918 526 7901 001	0918 526 6901 001	0918 526 5901 001	52,6	42,16			37,85	2,54 x 12 = 30,48	65,7
30	0918 530 7901 001	0918 530 6901 001	0918 530 5901 001	58,0	47,24			43,83	2,54 x 14 = 35,56	68,6
34	0918 534 7901 001	0918 534 6901 001	0918 534 5901 001	62,8	52,32			48,01	2,54 x 16 = 40,64	75,8
40	0918 540 7901 001	0918 540 6901 001	0918 540 5901 001	70,4	59,94			55,63	2,54 x 19 = 48,26	83,5
50	0918 550 7901 001	0918 550 6901 001	0918 550 5901 001	83,1	72,64			68,33	2,54 x 24 = 60,96	96,2
60	0918 560 7901 001	0918 560 6901 001	0918 560 5901 001	95,8	85,34			81,03	2,54 x 29 = 73,66	108,9
64	0918 564 7901 001	0918 564 6901 001	0918 564 5901 001	100,9	90,42			86,11	2,54 x 31 = 78,74	113,9

	All rights reserved	Created by	Inspected by	Standardisation	Date	State	
	Department EC PD - FR	DOUGE	BAGDIKIAN	HOFFMANN	2013-11-07	Final Release	
HARTING Electronics GmbH D-32339 Espelkamp		Title SEK 18 male STD angled with long levers				Doc-Key / ECM-Nr. 100553395/UGD/001/A 50000067148	
		Type	Number	Rev.		Page	
		TB	09185XXX90X	A		2/2	

