

### FEATURES

- Input voltage 2.7 V to 5.5 V**
- Evaluates 1 to 2 LED solutions**
- Configurable for 2-bit logic or I<sup>2</sup>C interface**
- Jumpers for measurement of flash LED current, coil current, and supply current**
- Evaluation software included**

### GENERAL DESCRIPTION

The evaluation system is composed of a motherboard and a daughterboard. The motherboard provides the I<sup>2</sup>C<sup>®</sup> signals from the computer USB port and generates the I/O voltages and digital high and low signals for the daughterboard. For temperature measurement, the daughterboard can either be

plugged directly into the motherboard or connected to the motherboard via the ribbon cable provided with the evaluation kit.

The motherboard features a 3.3 V regulator and two adjustable regulators, one for VDDIO and one for ADP1655 supply voltage (VIC). The daughterboard contains numerous jumpers and test points for easy evaluation of the board.

Full performance details are provided in the [ADP1655](#) data sheet, available from [www.analog.com](http://www.analog.com). The ADP1655 data sheet should be consulted in conjunction with this evaluation board data sheet.

### Warning

For safety reasons, do not look directly into the LEDs at close range. They are very bright and can cause eye injury.

### ADP1655 EVALUATION BOARD

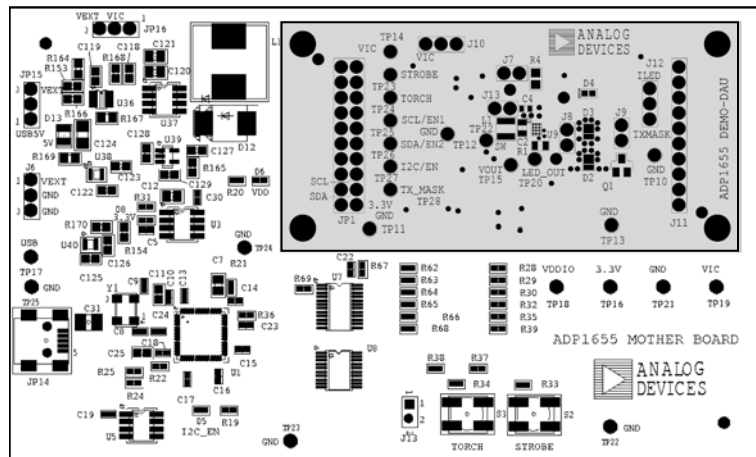

## TABLE OF CONTENTS

Features .....	1	Timeout Duration Programming.....	7
General Description .....	1	Fault Detection Status.....	7
ADP1655 Evaluation Board .....	1	LED Amount Detection .....	7
Revision History .....	2	History .....	7
Installation Instructions.....	3	Evaluation Board Overview .....	9
Installing ADP1655 Evaluation Software.....	3	Motherboard.....	9
Installing the USB Driver .....	4	Daughterboard.....	10
Using the Software GUI.....	5	Evaluation Board Schematics and Artwork.....	12
Hardware Configuration and Monitors .....	5	PCB Layout .....	14
LED Current Programming.....	6	Ordering Information.....	16
Software or Hardware STROBE for Flash.....	6	Bill Of Materials.....	16
Enabling Up to 500 mA LED Currents .....	7	Ordering Guide .....	17
Software or Hardware Torch.....	7	ESD Caution.....	17

## REVISION HISTORY

7/09—Revision 0: Initial Version

# INSTALLATION INSTRUCTIONS

## INSTALLING ADP1655 EVALUATION SOFTWARE

1. Insert the ADP1655-EVALZ setup CD into the CD-ROM and run the file **Setup.exe**. When the dialog box shown in Figure 2 appears, click **Next >>** to install the files to the default destination folder, or click **Browse...** to choose a different location.

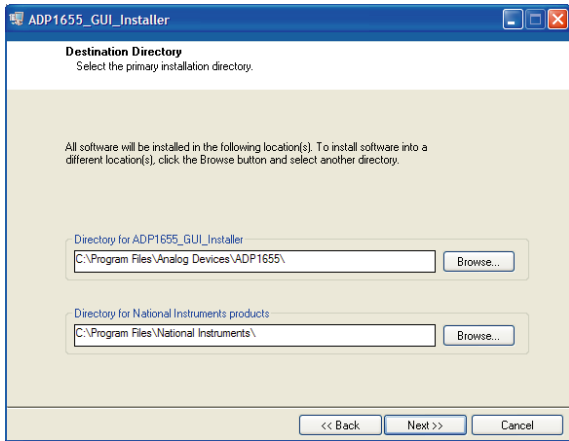

Figure 2. ADP1655 Evaluation Software Setup

2. Click **I accept the License Agreement(s)** and then **Next >>** to continue.

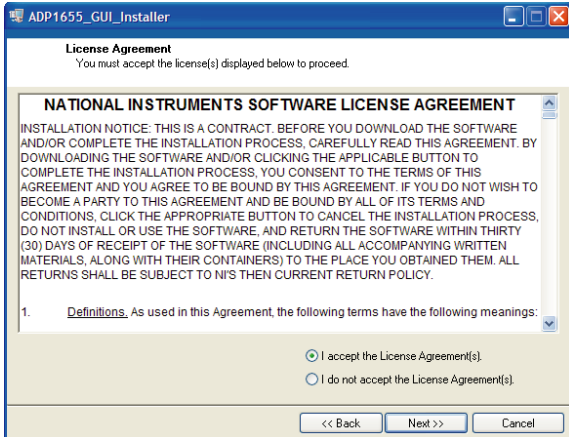

Figure 3. License Agreement

1. Click **Next >>** to continue.

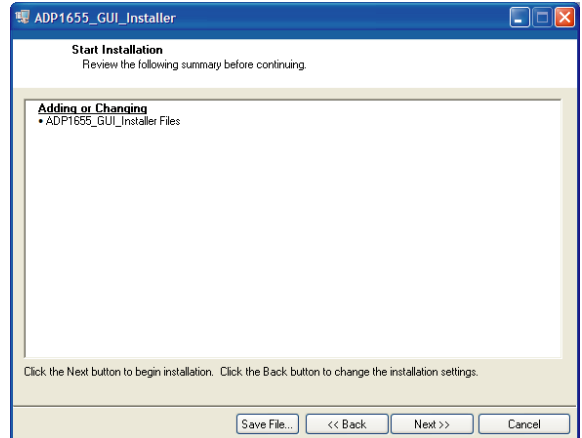

Figure 4. Installation Summary

3. Wait while the program installs.

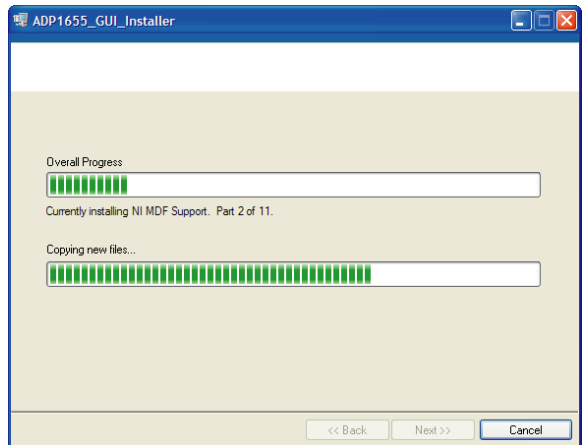

Figure 5. Installation Progress

4. Click **Finish** to complete installation.

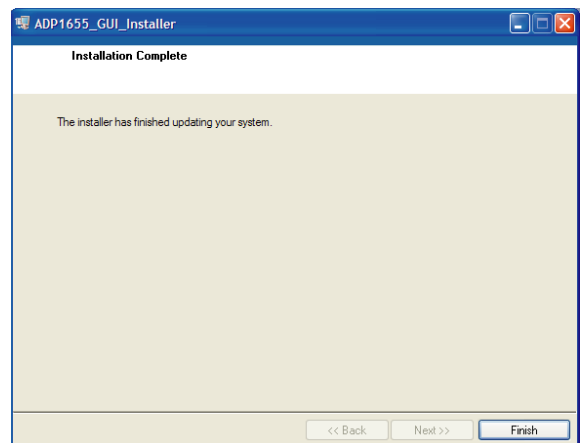

Figure 6. Installation Complete

# EVAL-ADP1655

5. After file installation is completed, the window in Figure 7 opens. Click **Restart** to complete the operation.

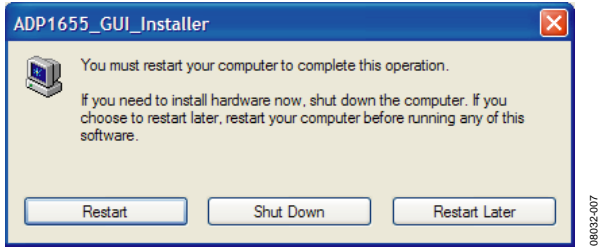

Figure 7. Restart Prompt Window

## INSTALLING THE USB DRIVER

1. Plug the ADP1655 board into the computer using the USB cable provided with the evaluation kit. When the system recognizes the board, the **Found New Hardware Wizard** dialog box appears.



Figure 8. New Hardware Wizard

2. Click **Next >** to install the driver.
3. Click **Continue Anyway** and then **Finish** to complete the driver installation.



Figure 9. New Hardware Installation

## USING THE SOFTWARE GUI



- 1VIC AND VDDIO VOLTAGE SETTINGS.  
 2VOLTAGE, CURRENT, AND EFFICIENCY MONITORS.  
 3DIGITAL INPUT CONTROLS.  
 4MOTHERBOARD HARDWARE ENABLE BUTTONS.

Figure 10. ADP1655 Graphical User Interface (GUI), Hardware Configuration and Monitors Window

08032-010

### HARDWARE CONFIGURATION AND MONITORS

Follow these three steps to load the ADP165 evaluation software:

1. Before running the software, ensure that the board is plugged into the computer USB port (USB5V LED, D13, on the motherboard should light up).
2. Click the **Start** button, located at the bottom left-hand corner of your desktop.
3. Select **All Programs**, then the **Analog Devices** folder, and then **ADP1655 Evaluation Software 0v3** to load the software (see Figure 10).

If you are powering the ADP1655 daughterboard from the motherboard (see Figure 16) you can change the VIC voltage by moving the **VIC voltage** slider and clicking **Update VIC**. The VDDIO voltage can be changed by moving the **Vddio voltage** slider and clicking **Update Vddio**.

Voltages and currents on the daughterboard can be monitored by clicking the **Monitor Voltages and Currents** button.

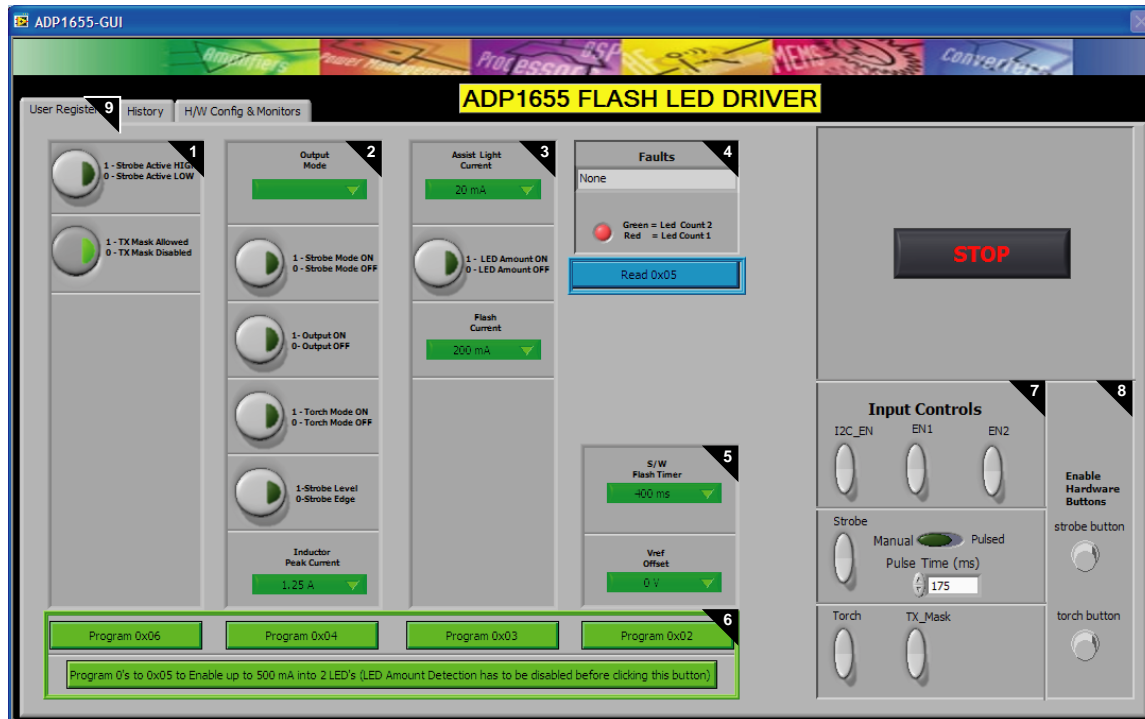

- 1 I<sup>2</sup>C REGISTER 0x06 CONTROLS: STROBE POLARITY, TX\_MASK ENABLE.
- 2 I<sup>2</sup>C REGISTER 0x04 CONTROLS: OUTPUT MODE, PEAK CURRENT LIMIT.
- 3 I<sup>2</sup>C REGISTER 0x03 CONTROLS: WHITE LED CURRENT SETTING.
- 4 I<sup>2</sup>C REGISTER 0x05 CONTROLS: FAULT REGISTER READ.
- 5 I<sup>2</sup>C REGISTER 0x02 CONTROLS: FLASH TIMER SETTING.
- 6 I<sup>2</sup>C REGISTER PROGRAM BUTTONS.
- 7 DIGITAL INPUT CONTROLS.
- 8 MOTHERBOARD HARDWARE ENABLE BUTTONS.
- 9 GUI PAGES: USER REGISTERS, HISTORY, AND H/W CONFIG & MONITORS.

Figure 11. ADP1655 Evaluation Software GUI, User Registers Window

08032-011

## LED CURRENT PROGRAMMING

Before changing settings in the ADP1655 registers, the I<sup>2</sup>C interface has to be enabled by clicking the I2C\_EN button (the button turns green and the I2C\_EN LED on the motherboard lights up) in Section 7 of the user registers window (see Figure 11). To program the LED current, set **Assist Light Current** and **Flash Current** in Section 3 and click the **Program 0x03** button. For USB powered demonstrations, a minimum **Flash Current** setting of 200 mA should be used to avoid exceeding the USB current source capability of 500 mA.

## SOFTWARE OR HARDWARE STROBE FOR FLASH

There are three ways to initiate Flash.

### I<sup>2</sup>C Enabled Flash

1. Set I2C\_EN in Section 7 of the user registers window.
2. In Section 2, set **Output Mode** to **Flash** and set **1- Output ON**.
3. Click the **Program 0x04** button to initiate Flash.

The length of the Flash event can be programmed by setting the value under **S/W Flash Timer** in Section 5 and clicking the **Program 0x02** button.

### STROBE Enabled Flash

1. Set I2C\_EN in Section 7 of the user registers window.
2. In Section 2, set **Output Mode** to **Flash**, set **1 - Strobe Mode ON**, and set **1- Output ON**.
3. Click the **Program 0x04** button.
4. Click the **Strobe** button in Section 7 to initiate Flash.

The length of the Flash event can be programmed by setting the value under **S/W Flash Timer** in Section 5 and clicking the **Program 0x02** button. To initiate Flash again, reprogram Register 0x04 and click **Strobe** again. STROBE can be enabled either from the user registers window by clicking **Strobe** under the **Input Controls** (Section 7) or from the hardware STROBE button on the motherboard. To use the hardware button, **strobe button** has to be enabled in Section 8 of the user registers window.

### EN1 and EN2 Enabled Flash

Note that it is recommended to use an external power supply for this operation because fixed Flash current values are set to 320 mA and 500 mA for two and one LED(s), respectively. Otherwise, the USB current sourcing limitation of 500 mA will be exceeded. Use the **I2C\_EN**, **EN1**, and **EN2** buttons in Section 7.

1. Set **I2C\_EN** low (button becomes gray).
2. Set **EN1** high (green). The red indicator LED (D4) should light up on the ADP1655 evaluation board.
3. Set **EN2** high (green) to initiate Flash.

### ENABLING UP TO 500 MA LED CURRENTS

The ADP1655 limits LED output current to 400 mA by default if two LEDs are used. In one-LED operation, currents of up to 500 mA are automatically allowed.

In I<sup>2</sup>C interface mode, it is possible for you to enable up to 500 mA of output currents in two-LED operation.

1. Set **I2C\_EN** in Section 7 of the user registers window.
2. Disable the amount of LED detection by selecting **0 - LED Amount OFF** in Section 3.
3. Click the **Program 0x03** button.
4. Click the **Program 0's to 0x05...** button in Section 6. This allows you to use any Flash current setting from 200 mA to 500 mA.

### SOFTWARE OR HARDWARE TORCH

#### I<sup>2</sup>C Logic Mode

1. Set **I2C\_EN** high (green) in Section 7 of the user registers window.
2. In Section 2, set **Output Mode** to **External Torch**, set **1 - Torch Mode ON**.
3. Click the **Program 0x04** button.

The torch current level can be programmed by setting the desired value under **Assist Light Current** in Section 3. To light up the LEDs, click the **Torch** button in Section 7. In addition, the **TORCH** hardware button on the motherboard can be used by clicking **torch button** in Section 8.

#### 2-Bit Logic Mode

1. Set **I2C\_EN** low (button becomes gray).
2. Click the **Torch** button in Section 7 (input controls) to light up the LEDs in torch mode, or use the **TORCH** hardware button on the motherboard, which must first be enabled via the **torch button** in Section 8 of the user registers window.

### TIMEOUT DURATION PROGRAMMING

Timeout is hardware limited to a maximum of 850 ms. Desired Flash timeouts can be set by changing the setting under the **S/W Flash Timer** box in Section 5 and clicking the **Program 0x02** button.

### FAULT DETECTION STATUS

**Faults** in Section 4 is used to read back the fault detection status from the ADP1655. Click **Read 0x05** to view information about the fault. **I2C\_EN** must be high (green) to be in read mode. Overvoltage fault occurs when the output voltage is greater than 9.5 V (typical). A timeout fault occurs when the **STROBE** button on the evaluation board is pressed longer than the programmed timeout duration in strobe level-sensitive mode. A thermal fault occurs when the device junction temperature is greater than 150°C. A short-circuit fault occurs if the **LED\_OUT** pin remains grounded during startup.

### LED AMOUNT DETECTION

The amount of LEDs is detected by the ADP1655 and the detection is enabled from **1 - LED Amount ON** in Section 3. The amount of LEDs is measured during the start of either Flash or torch, and the default level for whether one or two LEDs are connected to the output is set at 4.3 V (typical). Detection level can be changed to 4.3 V plus  $V_{REF}$  offset using the **Vref Offset** box.

### HISTORY

Whenever you issue a command (both read and write), it is recorded in the **History** tab, shown in Figure 12. To display the **History** dialog box, click the **History** tab on the evaluation software GUI. You can copy and paste the history into a file for future evaluation purposes.

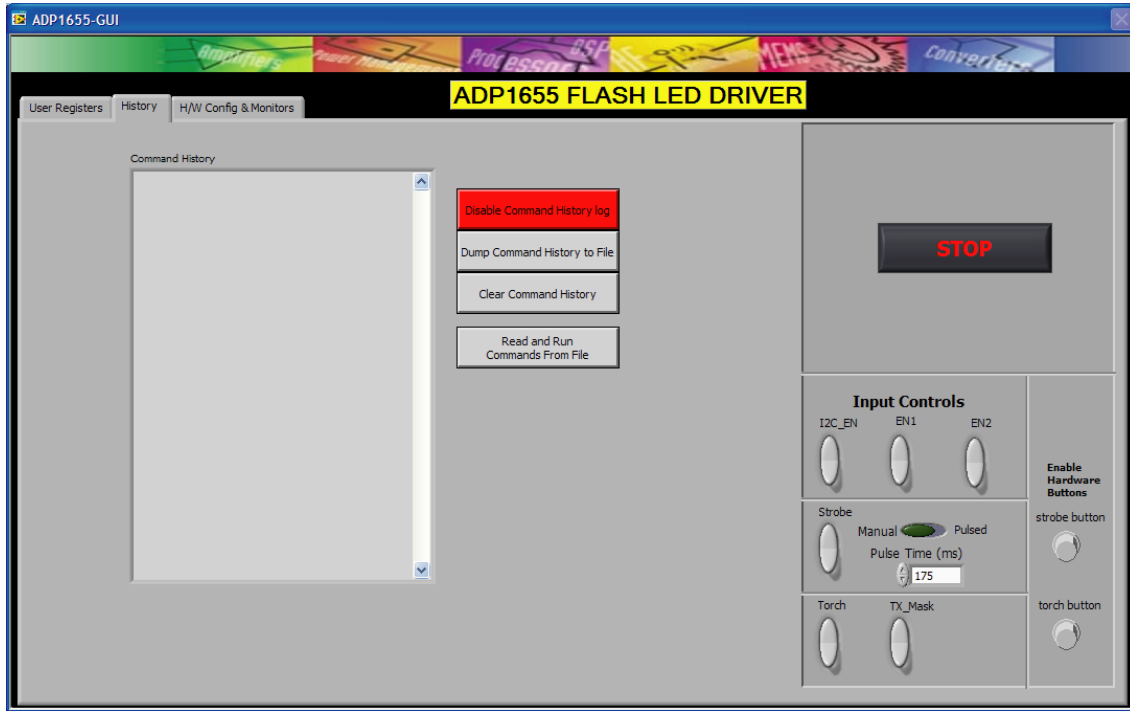

Figure 12. History



# EVALUATION BOARD OVERVIEW

## MOTHERBOARD

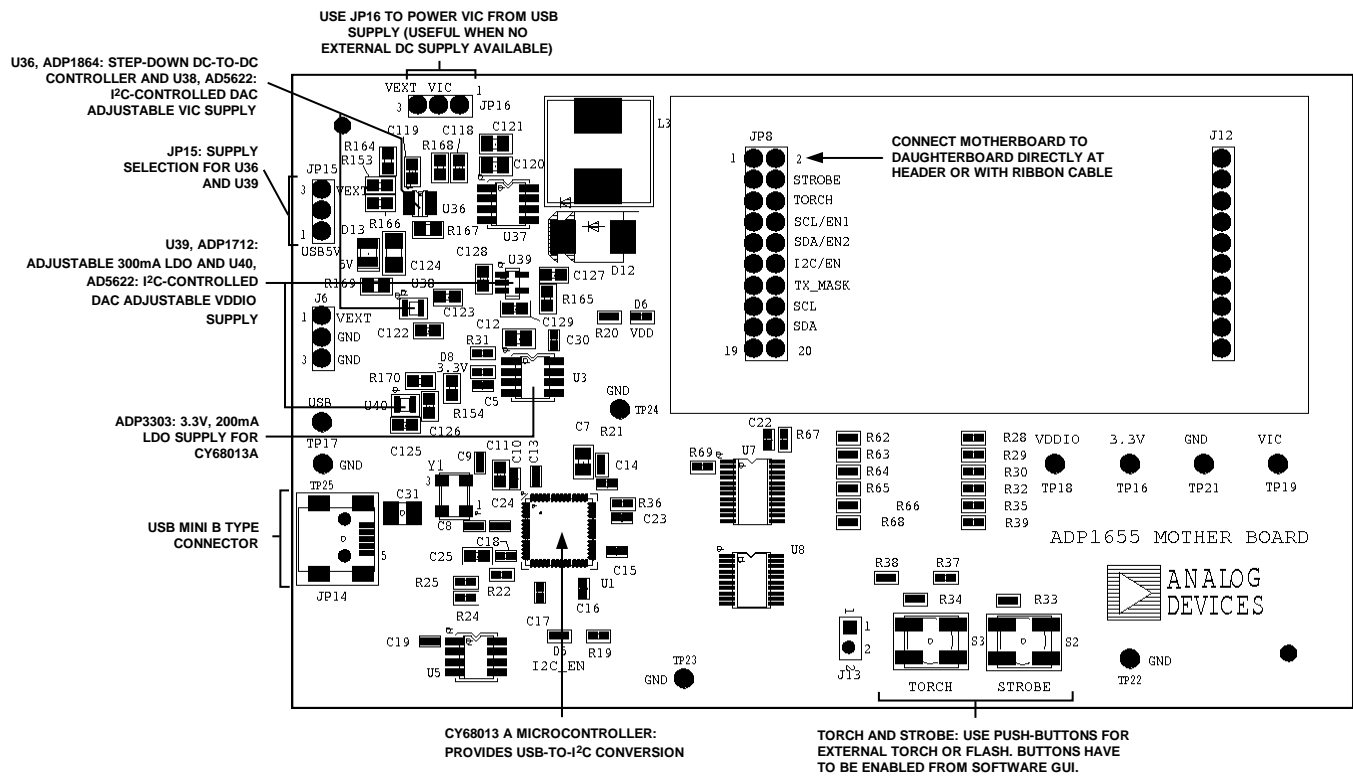

Figure 13. Motherboard

The ADP1655 motherboard provides the interface signals to the ADP1655 flash driver IC. Signals of the interface are controlled via the evaluation software GUI.

The Cypress Semiconductor Corporation CY68013A provides the USB interface and I<sup>2</sup>C signals. The selected I<sup>2</sup>C frequency is 400 kHz. The EEPROM U5 M24C64 provides the USB address of the board. The interface VDDIO voltage is adjusted using evaluation software GUI and is set to 1.9 V by default.

Typically, the daughterboard is inserted directly into the 20-pin header of the motherboard. For temperature measurements,

however, the ribbon cable provided with the evaluation kit must be used to connect the motherboard and the daughterboard because the Cypress CY68013A is not rated at -40°C.

Table 1. Recommended Jumper Setting

Jumper	Function	Setting
JP15	Motherboard regulator input voltage selection	Short 1 and 2 (USB powered)
JP16	ADP1655 input voltage selection	Open



## One-LED Evaluation

The J9 jumper can be placed to short D3 for the evaluation of the one-LED solution.

## Power Board from USB Port Only

To power the board via the USB without using an external supply, short Pin 1 and Pin 2 on both Jumper JP15 and

Jumper JP16 on the motherboard. Figure 16 illustrates jumper settings for USB powered operation. Ensure that the LED current is less than 200 mA to avoid exceeding the 500 mA current limit of the USB.

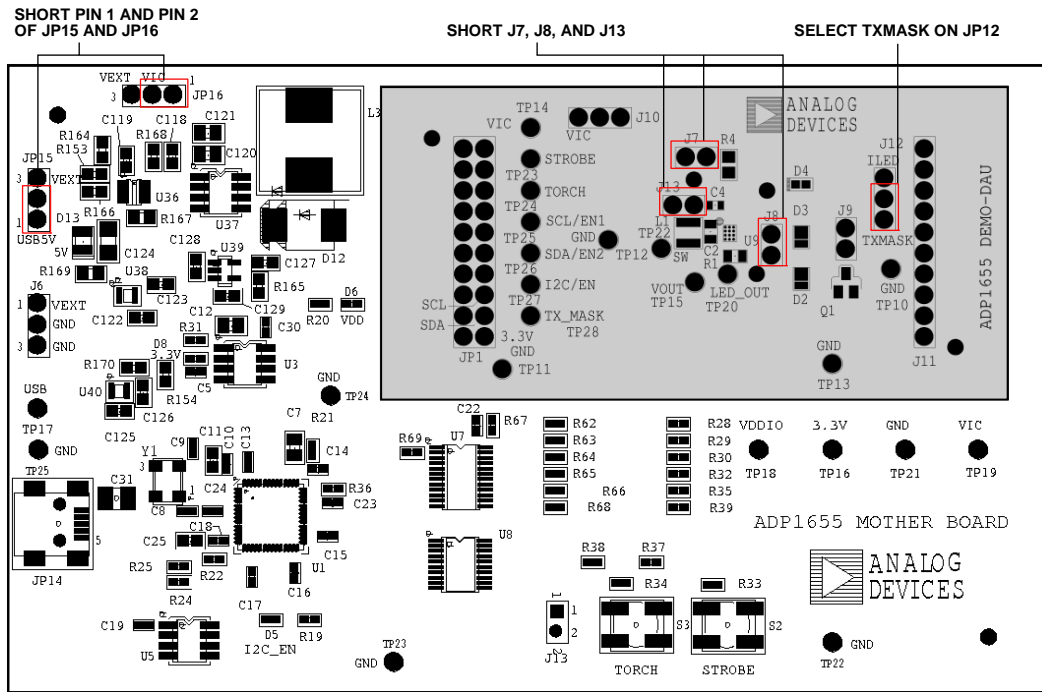

Figure 16. Powering ADP1655 from USB Port

086032-018



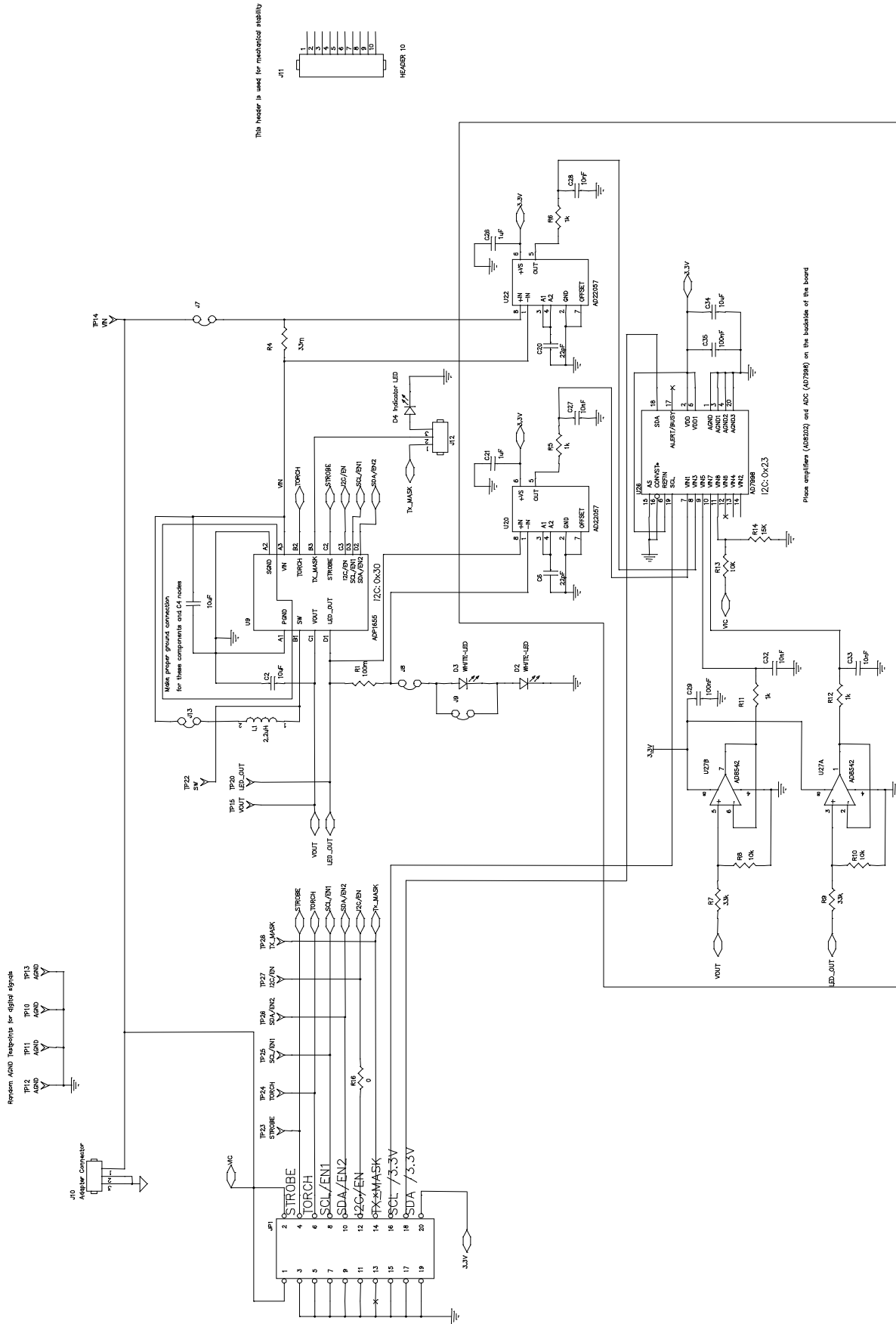

Figure 18. ADP1655 Evaluation Daughterboard Schematic  
Rev. 0 | Page 13 of 20

# EVAL-ADP1655

## PCB LAYOUT

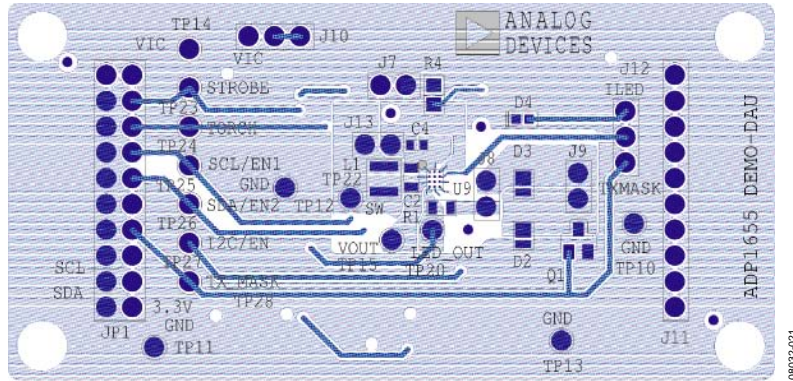

Figure 19. Evaluation Daughterboard Top Layer

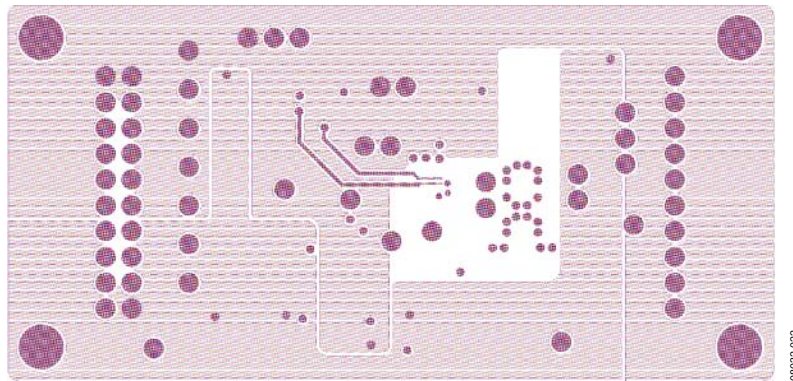

Figure 20. Evaluation Daughterboard VIC and 3.3 V Plane

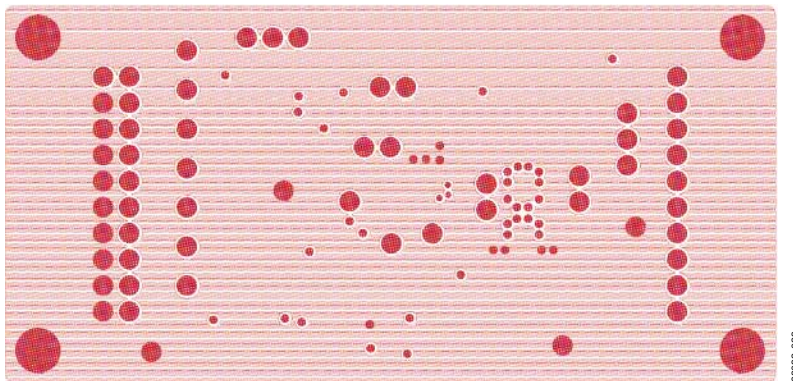

Figure 21. Evaluation Daughterboard GND Plane

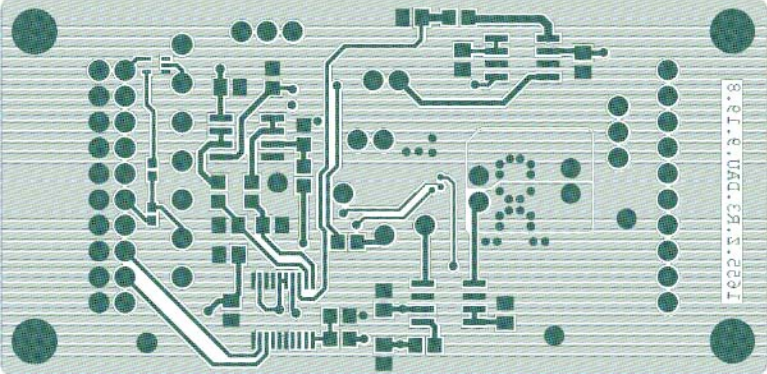

Figure 22. Evaluation Daughterboard Bottom Layer (View from the Top)

# EVAL-ADP1655

## ORDERING INFORMATION

### BILL OF MATERIALS

Table 2.

Description	Reference Designator	Qty	Manufacturer/Vendor	Part Number
<b>Daughterboard</b>				
Capacitor, MLCC, 10 $\mu$ F, 10 V, 0805, X5R	C2, C34	2	Murata	GRM21BR61A106K
Capacitor, MLCC, 10 $\mu$ F, 6.3 V, 0603, X5R	C4	1	TDK, Murata	C1608X5R0G106MT, GRM188R60J106ME
Capacitor, MLCC, 22 pF, 50 V, 0805, C0G	C6, C20	2	Vishay/Murata or equivalent	VJ0805A220JXACW1BC, GRM2165C1H220JZ01
Capacitor, MLCC, 1 $\mu$ F, 25 V, 0805, X7R	C21, C26	2	Murata/Taiyo Yuden	GRM219R71E105KA, TMK212BJ105KG-T
Capacitor, MLCC, 10 nF, 50 V, 0805, X7R	C27, C28, C32, C33	4	Vishay/Murata or equivalent	VJ0805Y103KXACW1BC, GRM2195C1H103JA01
Capacitor, MLCC, 100 nF, 50 V, 0805, X7R	C29, C35	2	Murata	GRM21BR71H104K
Resistor, 0.100 $\Omega$ , 1%, 0805, SMD	R1	1	Vishay or Equivalent	WSL0805R1000FEB
Resistor, 0.033 $\Omega$ , 1%, 0805, SMD	R4	1	Vishay or Equivalent	WSL0805R0330FEA
Resistor, 1 k $\Omega$ , 1%, 0805, SMD	R5, R6, R11, R12	4	Vishay or Equivalent	CRCW08051K00FKEA
Resistor, 33 k $\Omega$ , 1%, 0805, SMD	R7, R9	2	Vishay or Equivalent	CRCW080533K0FKEA
Resistor, 10 k $\Omega$ , 1%, 0805, SMD	R8, R10	2	Vishay or Equivalent	CRCW080510K0FKEA
Resistor, 10 k $\Omega$ , 1%, 0805, SMD	R13	1	Vishay or Equivalent	CRCW080510K0FKEA
Resistor, 15 k $\Omega$ , 1%, 0805, SMD	R14	1	Vishay or Equivalent	CRCW080515K0FKEA
Resistor, 0 $\Omega$ , 1%, 0402, SMD	R16	1	Vishay or Equivalent	CRCW04020K00FKEA
White LED	D2, D3	2	OSRAM/LumiLEDs	LUWC9SP or PWF4
Indicator LED, Red, 0402	D4	1	Lumex	SML-LX0402SIC-TR
Connector Header, 2 pins $\times$ 1	J7, J8, J9, J13	4	Samtec	TSW-150-07-T-S
Connector Header, 3 pins $\times$ 1	J10, J12	2	Samtec	TSW-150-07-T-S
Connector Header, 10 pins $\times$ 1	J11	1	Samtec	SSQ-110-01-G-S
Connector Header, 10 pins $\times$ 2	JP1	1	Samtec	SSW-110-03-G-D
Inductor, 2.2 $\mu$ H, 3 mm $\times$ 3 mm	L1	1	TOKO	FDSE0312-2R2M, DE2810C, DE2812C, or 1117AS-2R2M
Connector Header, 1 pin $\times$ 1	TP10 to TP15, TP20, TP22 to TP28	14	Samtec	TSW-150-07-T-S
ADP1655, 12-Ball WLCSP	U9	1	Analog Devices	ADP1655
AD22057, 8-Lead SOIC	U20, U22	2	Analog Devices	AD22057YRZ
AD7998, 20-Lead TSSOP	U26	1	Analog Devices	AD7998BRUZ
AD8542, 8-Lead SOIC	U27	1	Analog Devices	AD8542ARZ
<b>Motherboard</b>				
Capacitor, MLCC, 10 $\mu$ F, 10 V, 0805, X5R	C7	1	Murata	GRM219R61A106K
Capacitor, MLCC, 10 $\mu$ F, 10 V, 1206, X5R	C124	1	Murata	GRM31MR61A106K
Capacitor, MLCC, 100 nF, 16 V, 0402, X5R	C5, C13, C15 to C18, C22, C23, C30	9	Murata	GRM155R71C104K
Capacitor, MLCC, 2.2 $\mu$ F, 10 V, 0603, X5R	C11, C25	2	Murata	GRM188R61A225K
Capacitor, MLCC, 47 $\mu$ F, 10 V, 1210, X5R	C31	1	Murata	GRM32ER61A476K
Capacitor, MLCC, 6.2 pF, 50 V, 0402, C0G	C8, C9	2	Murata	GRM1555C1H6R2B
Capacitor, MLCC, 1 $\mu$ F, 10 V, 0402, X5R	C19	1	Murata	GRM155R61A105K
Capacitor, MLCC, 1 $\mu$ F, 10 V, 0603, X5R	C122, C125, C128	3	Murata	GRM188R61A105K
Capacitor, MLCC, 1 $\mu$ F, 25 V, 0805, X7R	C12	1	Murata	GRM21BR71E105K
Capacitor, MLCC, 10 nF, 50 V, 0402, X7R	C10, C24	2	Murata	GRM155R71H103K
Capacitor, MLCC, 10 nF, 50 V, 0603, X7R	C118, C129	2	Murata	GRM188R71H103K
Capacitor, MLCC, 22 $\mu$ F, 6.3 V, 0805, X5R	C120, C121	2	Murata	GRM21BR60J226M
Capacitor, MLCC, 1 nF, 50 V, 0402, X7R	C14	1	Murata	GRM155R71H102K
Capacitor, MLCC, 100 pF, 50 V, 0603, C0G	C123, C126	2	Vishay or equivalent	VJ0603A101JXACW1BC
Capacitor, MLCC, 270 pF, 50 V, 0603, C0G	C119	1	Vishay or equivalent	VJ0603A271JXACW1BC
Capacitor, MLCC, 4.7 $\mu$ F, 6.3 V, 0603, X5R	C127	1	Murata	GRM188R60J475K
Resistor, 1 k $\Omega$ , 1%, 0402, SMD	R19, R20, R31	3	Vishay or equivalent	CRCW04021K00FKED
Resistor, 100 k $\Omega$ , 1%, 0402, SMD	R21, R36	2	Vishay or equivalent	CRCW0402100KFKED



Description	Reference Designator	Qty	Manufacturer/Vendor	Part Number
Resistor, 330 Ω, 1%, 0402, SMD	R33, R34	2	Vishay or equivalent	CRCW0402330RFKED
Open	R37, R38	N/A	No assembly	No assembly
Resistor, 10 kΩ, 1%, 0402, SMD	R22	1	Vishay or equivalent	CRCW040210K0FKED
Resistor, 1.5 kΩ, 1%, 0402, SMD	R24, R25, R30, R32	4	Vishay or equivalent	CRCW04021K50FKED
Resistor, 4.7 kΩ, 1%, 0402, SMD	R28, R29, R35, R39	4	Vishay or equivalent	CRCW04024K70FKED
Resistor, 0 Ω, 1%, 0402, SMD	R62 to R66, R68	7	Vishay or equivalent	CRCW04020K00FKED
Resistor, 180 kΩ, 1%, 0402, SMD	R67	1	Vishay or equivalent	CRCW0402180KFKED
Resistor, 33 kΩ, 1%, 0402, SMD	R69	1	Vishay or equivalent	CRCW040233K0FKED
Resistor, 39 kΩ, 1%, 0603, SMD	R153, R154, R166, R170	4	Vishay or equivalent	CRCW060339K0FKEA
Resistor, 182 kΩ, 1%, 0603, SMD	R164	1	Vishay or equivalent	CRCW0603182KFKEA
Resistor, 27 kΩ, 1%, 0603, SMD	R165	1	Vishay or equivalent	CRCW060327K0FKEA
Resistor, 0.02 Ω, 1%, 0805, SMD	R167	1	Panasonic-ECG	ERJ-6BWF020V
Resistor, 1 kΩ, 1%, 0603, SMD	R168	1	Vishay or equivalent	CRCW06031K00FKEA
Resistor, 1 kΩ, 1%, 0805, SMD	R169	1	Vishay or equivalent	CRCW08051K00FKEA
LED, 0402, Green	D5, D6, D8	1	Lumex	SML-LX0402SUGC-TR
LED, 0805, Green	D13	1	Lumex	SML-LXT0805GW-TR
Diode Schottky, 15 V, 3 A, SMC	D12	1	Vishay, IR	30BQ015TRPBF
Connector Header, 2 pins × 1	J13	1	Sullins Electronics	PEC36SAAN
Connector Header, 10 pins × 1	J12	1	Sullins Electronics	PEC36SAAN
Connector Header, 10 pins × 2	JP8	1	Sullins Electronics	PEC36DAAN
Connector Header, 3 pins × 1	JP15, JP16, J6	3	Sullins Electronics	PEC36SAAN
Connector Receptacle, Mini USB2.0, 5-Position	JP14	1	Hirose Electronics	UX60-MB-5ST
Inductor, 2.2 μH, 10 mm × 9.7 mm × 4 mm	L3	1	TDK	VLF10040T-2R2N7R1
Switch Push-Button	S2, S3	2	C & K Components	KT11P3JM34LFS
Connector Header	TP16 to TP19, TP21	5	Sullins Electronics	PEC36SAAN
IC MCU USB Peripheral High Speed 56-QFN	U1	1	Cypress Semiconductor	CY7C68013A-56LFXC
ADP3303, 3.3 V	U3	1	Analog Devices	ADP3303-3.3V
IC SRL EEPROM I <sup>2</sup> C, 64 kB, SO-8	U5	1	STMicroelectronics	M24C64
IC 10-Bit Voltage Clamp, 24-TSSOP	U7	1	NXP Semiconductors	GTL2010PW
ADG734BRUZ, 20-Lead TSSOP	U8	1	Analog Devices	ADG734BRUZ
ADP1864, 6-Lead TSOT	U36	1	Analog Devices	ADP1864AUJZ
MOSFET P-Channel, 20 V, 9.8 A, 8-SOIC	U37	1	Vishay/Siliconix	SI4463BDY
AD5622, SC70, Date Code Later Than 0749	U38, U40	2	Analog Devices	AD5622YKSZ
ADP1712, 5-Lead TSOT	U39	1	Analog Devices	ADP712AUJZ-R7
Crystal, 24 MHz	Y1	1	CTS Electronic Components	CTX651CT

## ORDERING GUIDE

Model	Description
ADP1655-EVALZ <sup>1</sup>	Evaluation Board

<sup>1</sup>Z = RoHS Compliant Part.

## ESD CAUTION



**ESD (electrostatic discharge) sensitive device.** Charged devices and circuit boards can discharge without detection. Although this product features patented or proprietary protection circuitry, damage may occur on devices subjected to high energy ESD. Therefore, proper ESD precautions should be taken to avoid performance degradation or loss of functionality.

**NOTES**

**NOTES**

**NOTES**