



**PART NUMBER:** GC0351P-3

**DESCRIPTION:** speaker

**SPECIFICATIONS**

nominal size	16 x 35 mm		
impedance	4 Ohm $\pm$ 15%	at	1.2 KHz 2 V
resonant frequency	630 Hz $\pm$ 126 Hz	at	2 V
sound pressure level	82 dB/w $\pm$ 3 dB	1 w 50 cm ave. at 0.6K, 0.8K, 1K, 1.2K Hz	
response	Fo Hz ~ 13 KHz max 10 dB		
input power	nominal 1 W	handling capacity	2 W
operation	must be normal at program source 1 W		
buzz, rattle, etc.	must be normal at sine wave 2 V		
magnet	size: 8.1 x 1.4 mm		
load test	white noise 1 W	for	24 hours
heat test	65 $\pm$ 2° C	20-50% R.H.	24 hours
humidity test	40 $\pm$ 2° C	90-95% R.H.	24 hours

**FREQUENCY RESPONSE CURVE**

potentiometer range	50 dB
rectifier	RMS
lower limit frequency	20 Hz
wr. speed	100 mm/sec

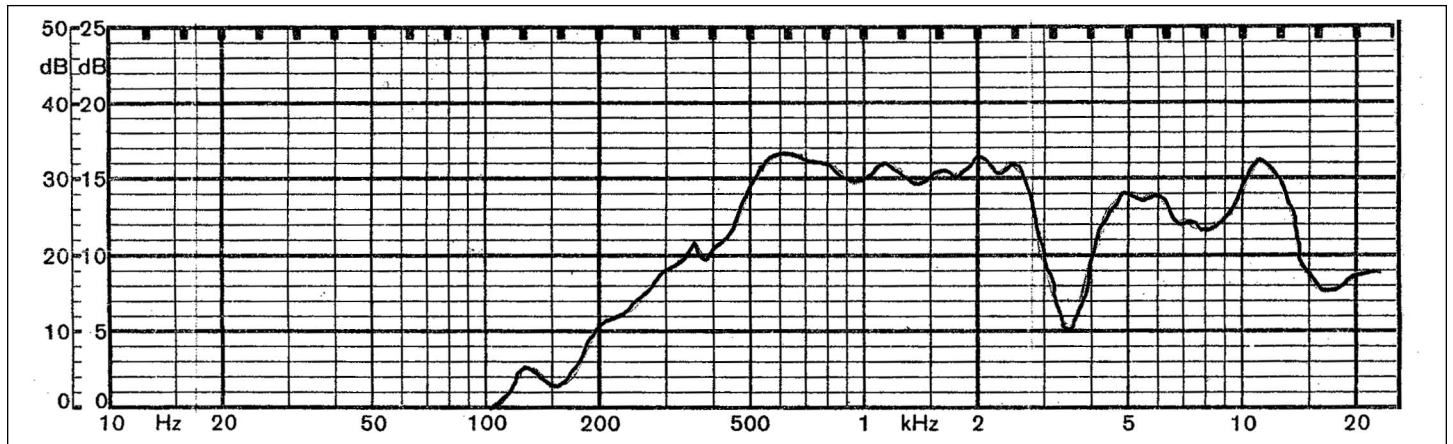

zero level 50 dB

REV.	DESCRIPTION	DATE
A	NEW DRAWING	12/12/2006

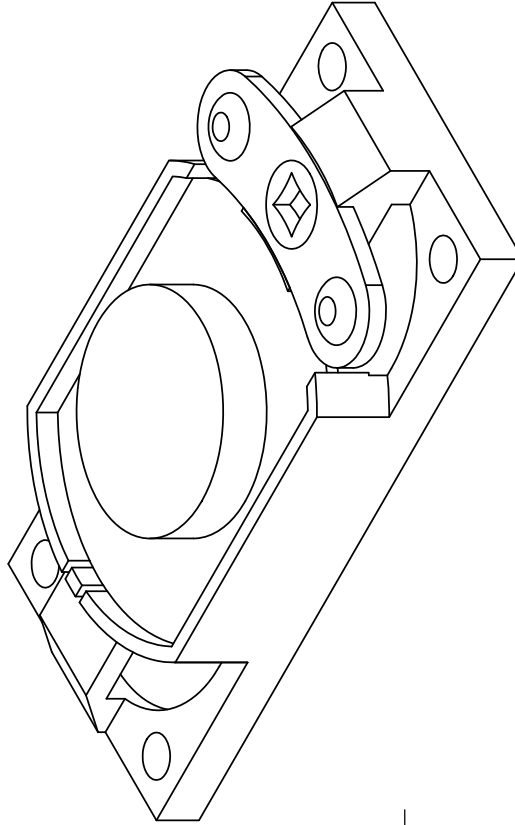
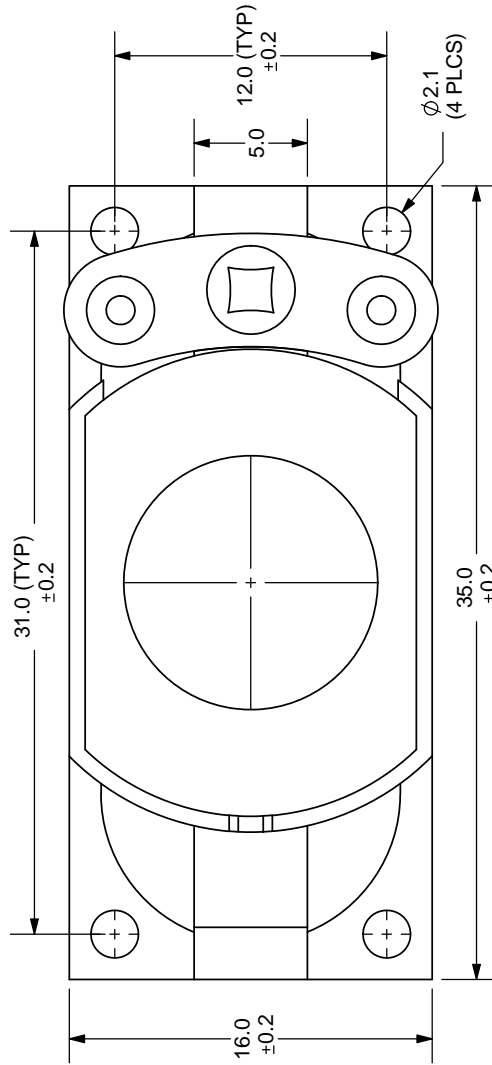
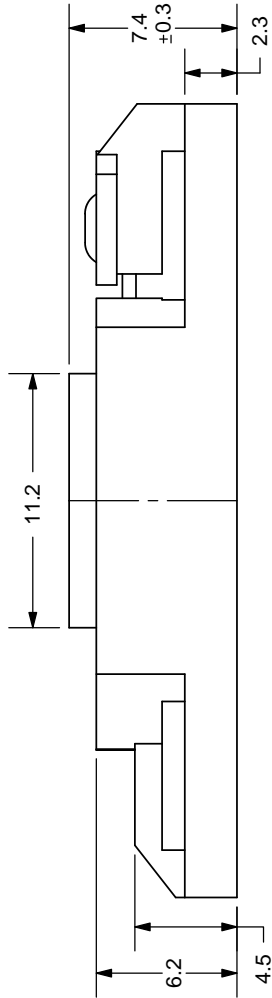

TOLERANCE:  
±0.5mm UNLESS OTHERWISE  
SPECIFIED



**CUI INC**

20050 SW 112th Ave.  
Tualatin, OR 97062  
Phone: 503-643-4899  
800-275-4899  
Fax: 503-372-1266  
Website: www.cui.com

TITLE:	LOW PROFILE NOTEBOOK SPEAKER	REV:	A
PART NO:	GC0351P-3	UNITS:	MM [INCHES]
DRAWN BY:	ZRJ	APPROVED BY:	
		SCALE:	3:1