

NTLUF4189NZ

Power MOSFET and Schottky Diode

30 V, N-Channel with 0.5 A Schottky Barrier Diode, 1.6 x 1.6 x 0.55 mm μ Cool™ Package

Features

- Low Qg and Capacitance to Minimize Switching Losses
- Low Profile UDFN 1.6x1.6 mm for Board Space Saving
- Low VF Schottky Diode
- ESD Protected Gate
- This is a Halide-Free Device
- This is a Pb-Free Device

Applications

- DC-DC Boost Converter
- Color Display and Camera Flash Regulators
- Optimized for Power Management Applications for Portable Products, such as Cell Phones, PMP, DSC, GPS, and others

MAXIMUM RATINGS (T_J = 25°C unless otherwise stated)

Parameter			Symbol	Value	Units
Drain-to-Source Voltage			V _{DSS}	30	V
Gate-to-Source Voltage			V _{GS}	±8.0	V
Continuous Drain Current (Note 1)	Steady State	T _A = 25°C	I _D	1.5	A
		T _A = 85°C		1.1	
	t ≤ 5 s	T _A = 25°C		1.9	
Power Dissipation (Note 1)	Steady State	T _A = 25°C	P _D	0.8	W
		t ≤ 5 s		T _A = 25°C	
Continuous Drain Current (Note 2)	Steady State	T _A = 25°C	I _D	1.2	A
		T _A = 85°C		0.9	
Power Dissipation (Note 2)		T _A = 25°C	P _D	0.5	W
Pulsed Drain Current		t _p = 10 μs	I _{DM}	8.0	A
MOSFET Operating Junction and Storage Temperature			T _J , T _{STG}	-55 to 150	°C
Schottky Operating Junction & Storage Temperature			T _J , T _{STG}	-55 to 125	°C
Source Current (Body Diode) (Note 2)			I _S	1.5	A
Lead Temperature for Soldering Purposes (1/8" from case for 10 s)			T _L	260	°C
Gate-to-Source ESD Rating (HBM) per JESD22-A114F			ESD	1000	V

Stresses exceeding Maximum Ratings may damage the device. Maximum Ratings are stress ratings only. Functional operation above the Recommended Operating Conditions is not implied. Extended exposure to stresses above the Recommended Operating Conditions may affect device reliability.

1. Surface Mounted on FR4 Board using 1 in sq pad size (Cu area = 1.127 in sq [2 oz] including traces).
2. Surface-mounted on FR4 board using the minimum recommended pad size of 30 mm², 2 oz. Cu.



ON Semiconductor®

<http://onsemi.com>

MOSFET

V _{(BR)DSS}	R _{DS(on)} MAX	I _D MAX
30 V	200 mΩ @ 4.5 V	1.5 A
	250 mΩ @ 3.0 V	0.5 A
	350 mΩ @ 2.5 V	0.5 A

SCHOTTKY DIODE

V _R MAX	V _F TYP	I _F MAX
30 V	0.52 V	0.5 A

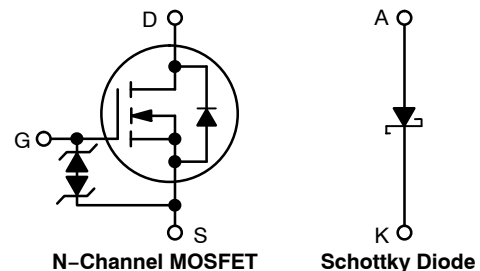

MARKING DIAGRAM



AA = Specific Device Code
M = Date Code
■ = Pb-Free Package

PIN CONNECTIONS

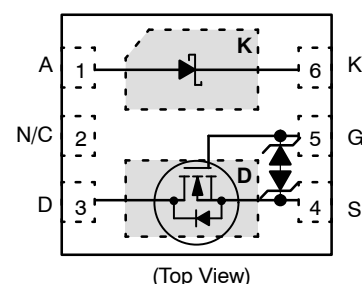

ORDERING INFORMATION

See detailed ordering and shipping information in the package dimensions section on page 2 of this data sheet.

NTLUF4189NZ

DEVICE ORDERING INFORMATION

Device	Package	Shipping [†]
NTLUF4189NZTAG	UDFN6 (Pb-Free)	3000 / Tape & Reel
NTLUF4189NZTBG	UDFN6 (Pb-Free)	3000 / Tape & Reel

[†]For information on tape and reel specifications, including part orientation and tape sizes, please refer to our Tape and Reel Packaging Specifications Brochure, BRD8011/D.

Schottky Diode Maximum Ratings (T_J = 25°C unless otherwise stated)

Parameter	Symbol	Value	Units
Peak Repetitive Reverse Voltage	V _{RRM}	30	V
DC Blocking Voltage	V _R	30	V
Average Rectified Forward Current	I _F	0.5	A

Thermal Resistance Ratings

Parameter	Symbol	Max	Units
Junction-to-Ambient – Steady State (Note 3)	R _{θJA}	155	°C/W
Junction-to-Ambient – t ≤ 5 s (Note 3)	R _{θJA}	100	
Junction-to-Ambient – Steady State min Pad (Note 4)	R _{θJA}	245	

MOSFET Electrical Characteristics (T_J = 25°C unless otherwise specified)

Parameter	Symbol	Test Condition	Min	Typ	Max	Units
-----------	--------	----------------	-----	-----	-----	-------

OFF CHARACTERISTICS

Drain-to-Source Breakdown Voltage	V _{(BR)DSS}	V _{GS} = 0 V, I _D = 250 μA	30			V
Drain-to-Source Breakdown Voltage Temperature Coefficient	V _{(BR)DSS} /T _J	I _D = 250 μA, ref to 25°C		22		mV/°C
Zero Gate Voltage Drain Current	I _{DSS}	V _{GS} = 0 V, V _{DS} = 24 V	T _J = 25°C		1.0	μA
			T _J = 85°C		10	
Gate-to-Source Leakage Current	I _{GSS}	V _{DS} = 0 V, V _{GS} = ± 8.0 V			10	μA

ON CHARACTERISTICS (Note 5)

Gate Threshold Voltage	V _{GS(TH)}	V _{GS} = V _{DS} , I _D = 250 μA	0.4	1.1	1.5	V
Negative Threshold Temp. Coefficient	V _{GS(TH)} /T _J			3.0		mV/°C
Drain-to-Source On Resistance	R _{DS(on)}	V _{GS} = 4.5 V, I _D = 1.5 A		145	200	mΩ
		V _{GS} = 3.0 V, I _D = 0.5 A		185	250	
		V _{GS} = 2.5 V, I _D = 0.5 A		220	350	
Forward Transconductance	g _{FS}	V _{DS} = 4.0 V, I _D = 0.15 A		1.1		S

CHARGES & CAPACITANCES

Input Capacitance	C _{ISS}	V _{GS} = 0 V, f = 1 MHz, V _{DS} = 15 V		95		pF
Output Capacitance	C _{OSS}			15		
Reverse Transfer Capacitance	C _{RSS}			10		
Total Gate Charge	Q _{G(TOT)}	V _{GS} = 4.5 V, V _{DS} = 15 V; I _D = 1.5 A		1.4	3.0	nC
Threshold Gate Charge	Q _{G(TH)}			0.2		
Gate-to-Source Charge	Q _{GS}			0.4		
Gate-to-Drain Charge	Q _{GD}			0.4		

- Surface-mounted on FR4 board using 1 in sq pad size (Cu area = 1.127 in sq [2 oz] including traces)
- Surface-mounted on FR4 board using the minimum recommended pad size of 30 mm², 2 oz. Cu.
- Pulse Test: pulse width ≤ 300 μs, duty cycle ≤ 2%
- Switching characteristics are independent of operating junction temperatures

NTLUF4189NZ

MOSFET Electrical Characteristics (T_J = 25°C unless otherwise specified)

Parameter	Symbol	Test Condition	Min	Typ	Max	Units
SWITCHING CHARACTERISTICS, V_{GS} = 4.5 V (Note 6)						
Turn-On Delay Time	t _{d(ON)}	V _{GS} = 4.5 V, V _{DD} = 15 V, I _D = 1A, R _G = 6 Ω		7.0		ns
Rise Time	t _r			4.5		
Turn-Off Delay Time	t _{d(OFF)}			10.2		
Fall Time	t _f			1.2		

DRAIN-SOURCE DIODE CHARACTERISTICS

Forward Diode Voltage	V _{SD}	V _{GS} = 0 V, I _S = 1A	T _J = 25°C		0.8	1.2	V
			T _J = 85°C		0.75		
Reverse Recovery Time	t _{RR}	V _{GS} = 0 V, dI _{SD} /dt = 100 A/μs, I _S = 1 A		10.5		ns	
Charge Time	t _a			8.9			
Discharge Time	t _b			1.6			
Reverse Recovery Charge	Q _{RR}			2.1			nC

SCHOTTKY DIODE ELECTRICAL CHARACTERISTICS (T_J = 25°C unless otherwise specified)

Parameter	Symbol	Test Condition	Min	Typ	Max	Units
Maximum Instantaneous Forward Voltage	V _F	I _F = 10 mA		0.27	0.37	V
		I _F = 100 mA		0.36	0.46	
		I _F = 500 mA		0.52	0.62	
Maximum Instantaneous Reverse Current	I _R	V _R = 10 V		2.0	10	μA
		V _R = 30 V		20	200	

SCHOTTKY DIODE ELECTRICAL CHARACTERISTICS (T_J = 85°C unless otherwise specified)

Maximum Instantaneous Forward Voltage	V _F	I _F = 10 mA		0.2		V
		I _F = 100 mA		0.3		
		I _F = 500 mA		0.51		
Maximum Instantaneous Reverse Current	I _R	V _R = 10 V		80		μA
		V _R = 30 V		525		

SCHOTTKY DIODE ELECTRICAL CHARACTERISTICS (T_J = 125°C unless otherwise specified)

Maximum Instantaneous Forward Voltage	V _F	I _F = 10 mA		0.14		V
		I _F = 100 mA		0.27		
		I _F = 500 mA		0.51		
Maximum Instantaneous Reverse Current	I _R	V _R = 10 V		600		μA
		V _R = 30 V		3000		

SCHOTTKY DIODE ELECTRICAL CHARACTERISTICS (T_J = 25°C unless otherwise specified)

Capacitance	C	V _R = 5 V, f = 1.0 MHz		6.0		pF
-------------	---	-----------------------------------	--	-----	--	----

- Surface-mounted on FR4 board using 1 in sq pad size (Cu area = 1.127 in sq [2 oz] including traces)
- Surface-mounted on FR4 board using the minimum recommended pad size of 30 mm², 2 oz. Cu.
- Pulse Test: pulse width ≤ 300 μs, duty cycle ≤ 2%
- Switching characteristics are independent of operating junction temperatures

TYPICAL MOSFET CHARACTERISTICS

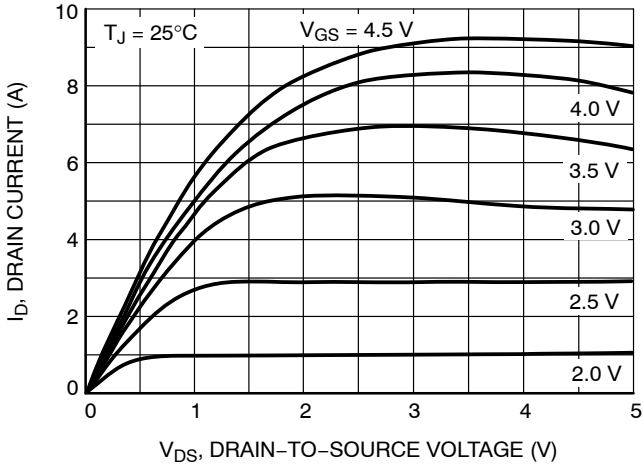

Figure 1. On-Region Characteristics

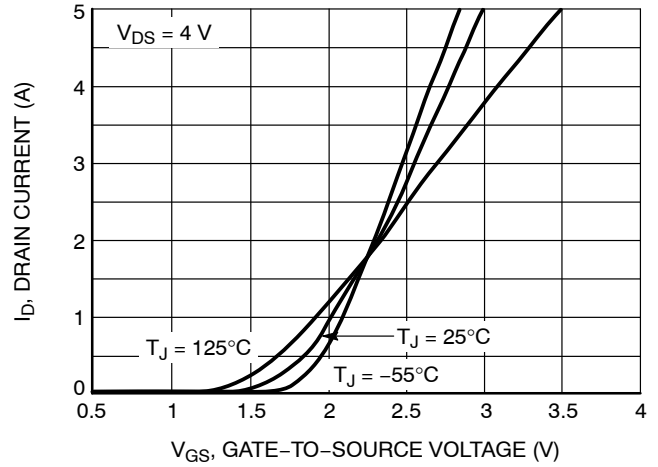

Figure 2. Transfer Characteristics

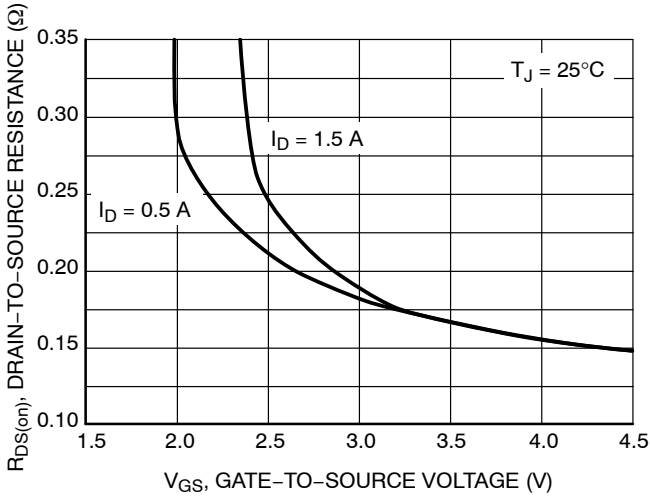

Figure 3. On-Resistance vs. Gate Voltage

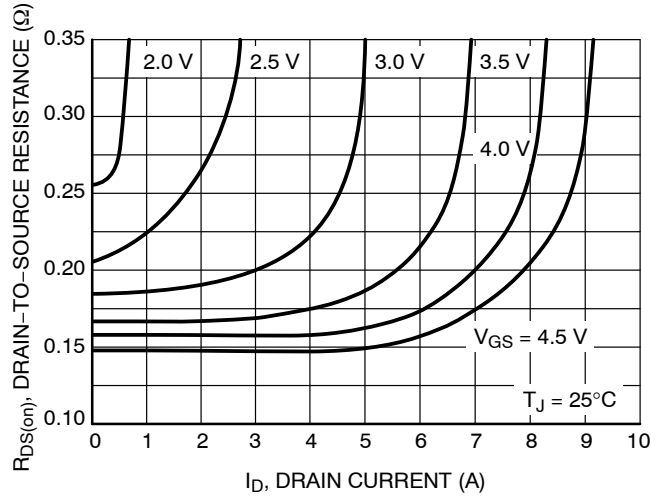

Figure 4. On-Resistance vs. Drain Current and Gate Voltage

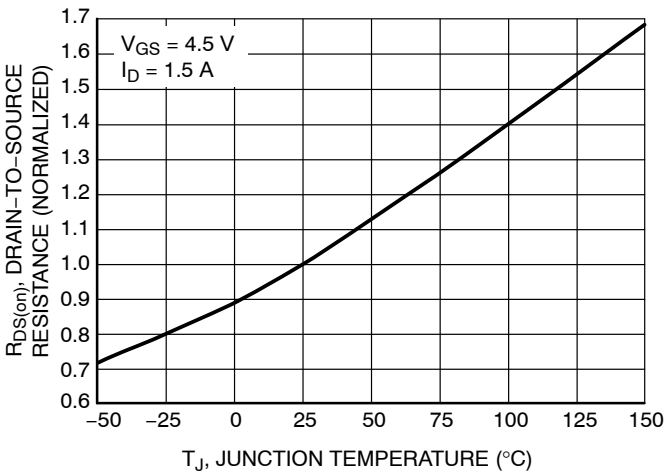

Figure 5. On-Resistance Variation with Temperature

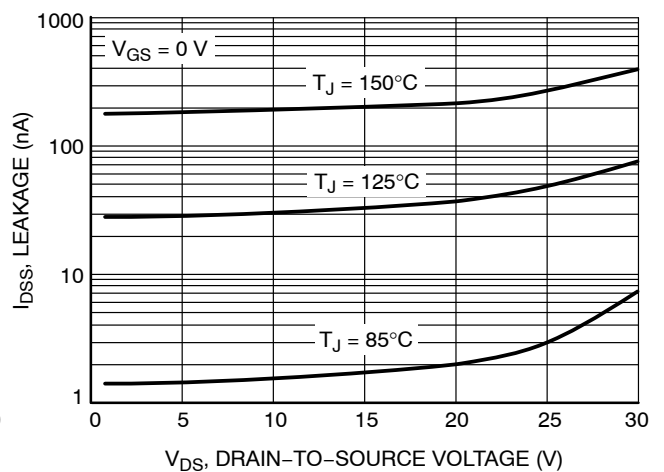

Figure 6. Drain-to-Source Leakage Current vs. Voltage

TYPICAL MOSFET CHARACTERISTICS

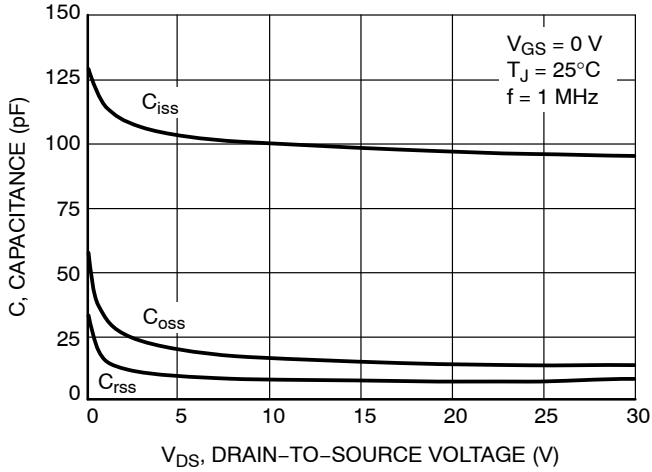

Figure 7. Capacitance Variation

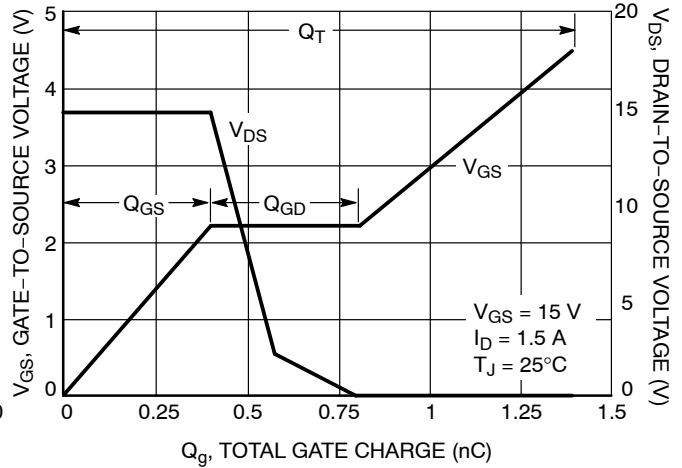

Figure 8. Gate-to-Source and Drain-to-Source Voltage vs. Total Charge

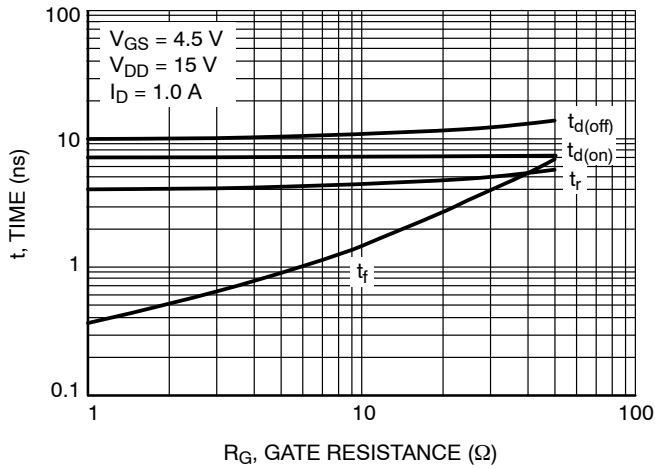

Figure 9. Resistive Switching Time Variation vs. Gate Resistance

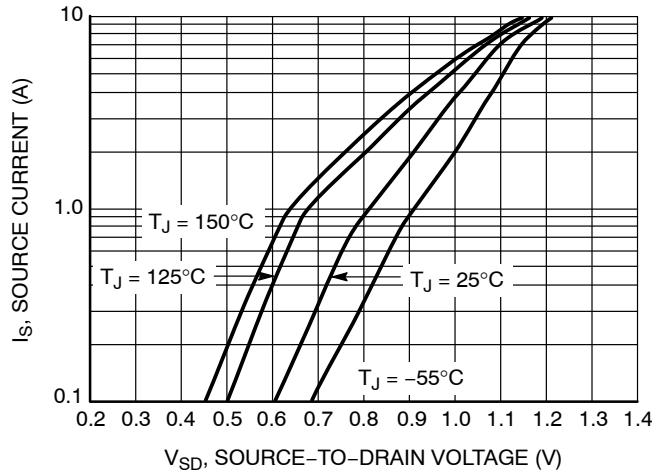

Figure 10. Diode Forward Voltage vs. Current

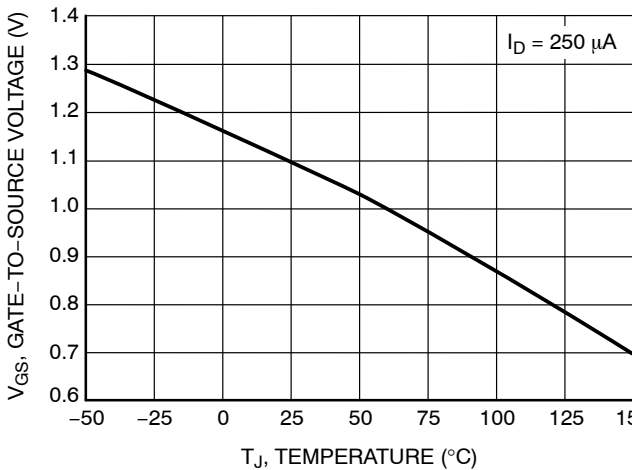

Figure 11. Threshold Voltage

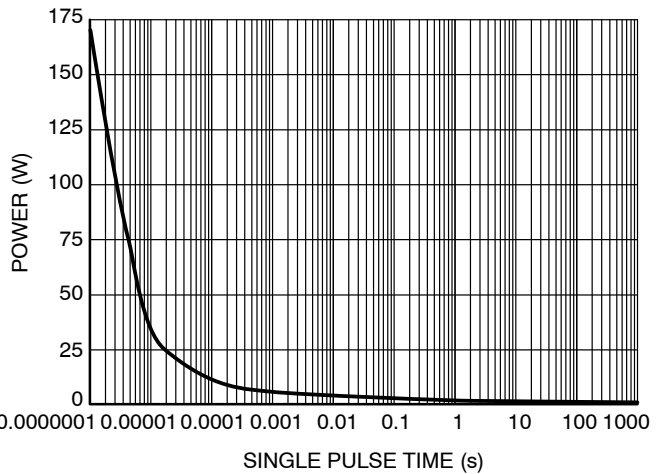

Figure 12. Single Pulse Maximum Power Dissipation

NTLUF4189NZ

TYPICAL MOSFET CHARACTERISTICS

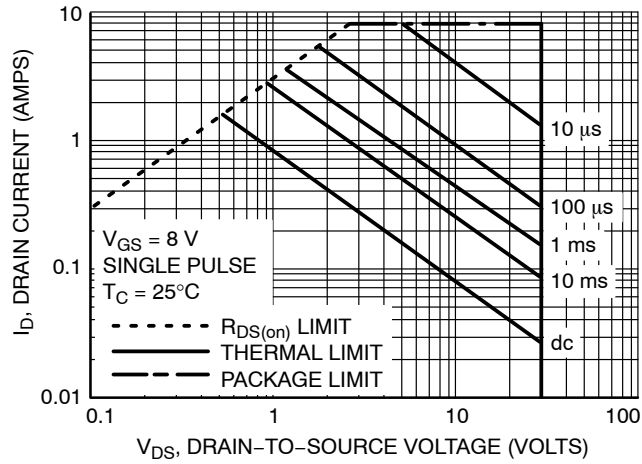

Figure 13. Maximum Rated Forward Biased Safe Operating Area

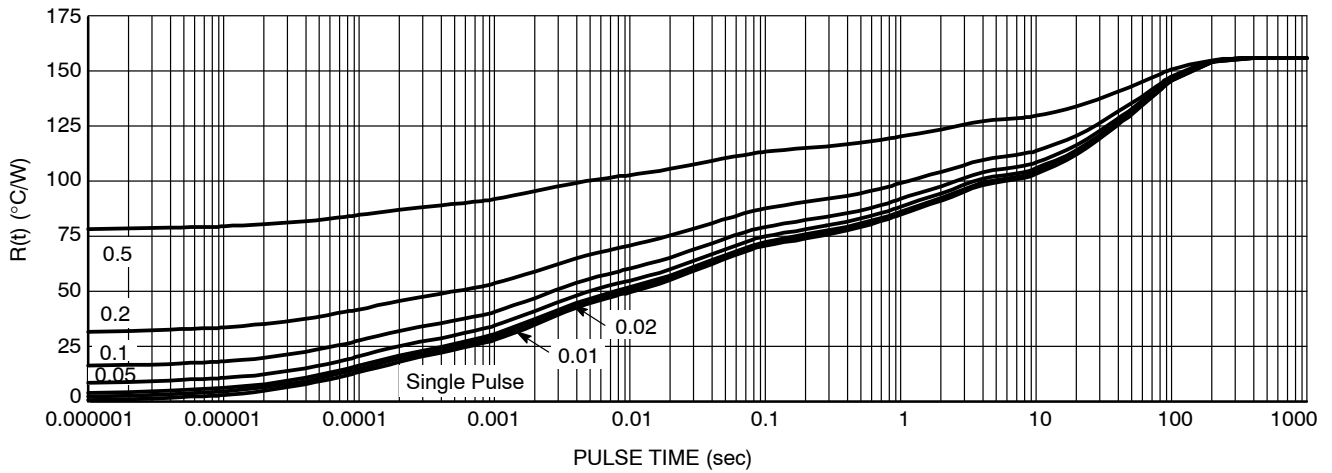

Figure 14. FET Thermal Response

NTLUF4189NZ

TYPICAL SCHOTTKY CHARACTERISTICS

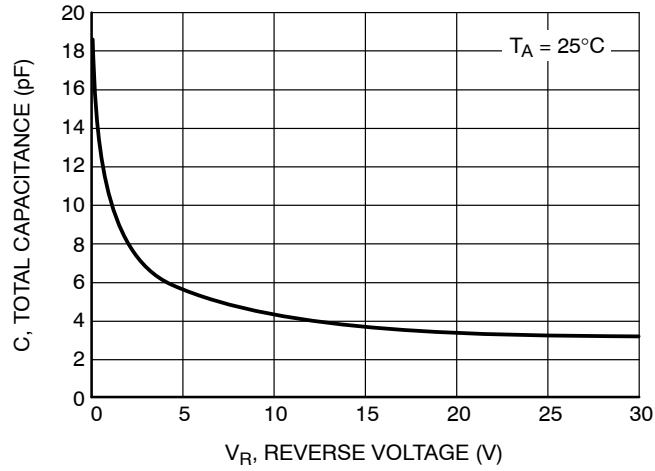

Figure 15. Total Capacitance

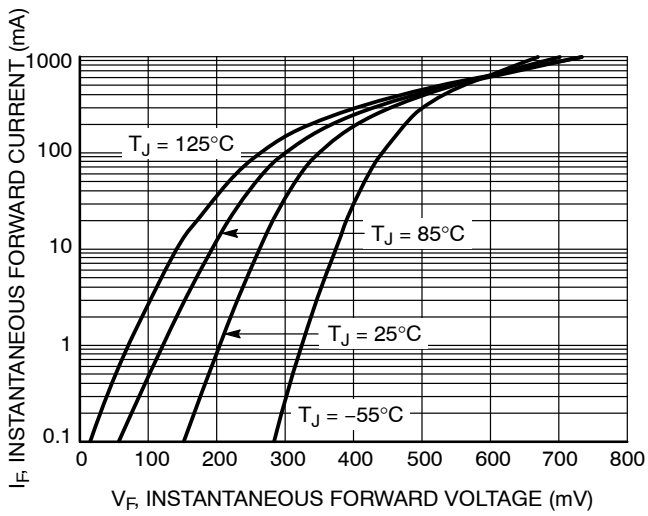

Figure 16. Typical Forward Voltage

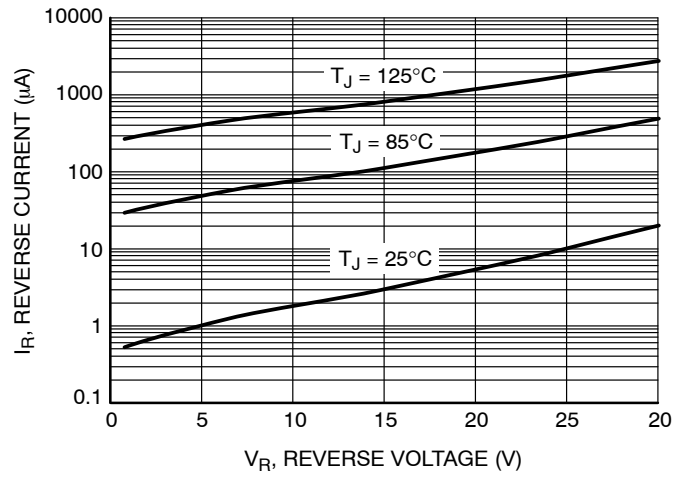
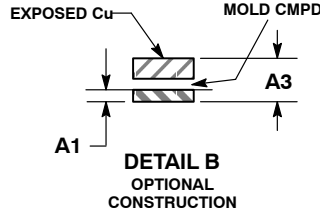
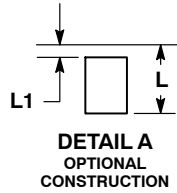
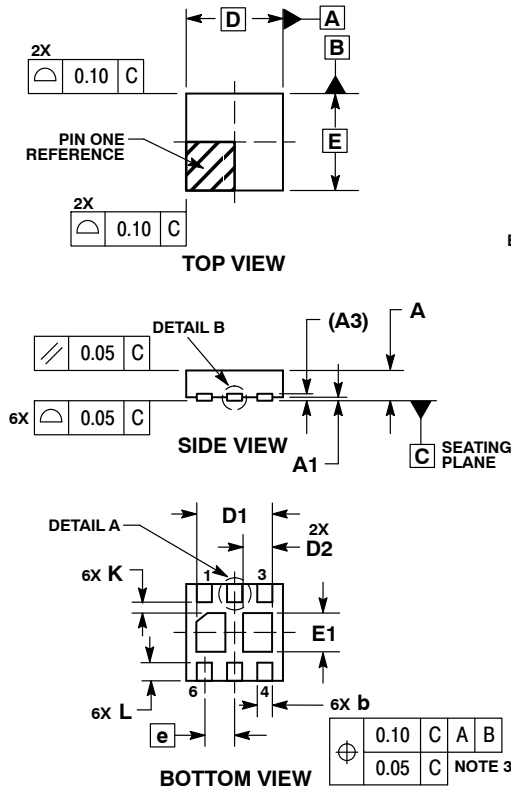

Figure 17. Typical Reverse Current

NTLUF4189NZ

PACKAGE DIMENSIONS

UDFN6 1.6x1.6, 0.5P
CASE 517AT-01
ISSUE O



NOTES:

1. DIMENSIONING AND TOLERANCING PER ASME Y14.5M, 1994.
2. CONTROLLING DIMENSION: MILLIMETERS.
3. DIMENSION b APPLIES TO PLATED TERMINAL AND IS MEASURED BETWEEN 0.15 AND 0.30 mm FROM TERMINAL.
4. COPLANARITY APPLIES TO THE EXPOSED PAD AS WELL AS THE TERMINALS.

MILLIMETERS		
DIM	MIN	MAX
A	0.45	0.55
A1	0.00	0.05
A3	0.13	REF
b	0.20	0.30
D	1.60	BSC
E	1.60	BSC
e	0.50	BSC
D1	1.14	1.34
D2	0.38	0.58
E1	0.54	0.74
K	0.20	---
L	0.15	0.35
L1	---	0.10

SOLDERMASK DEFINED MOUNTING FOOTPRINT*

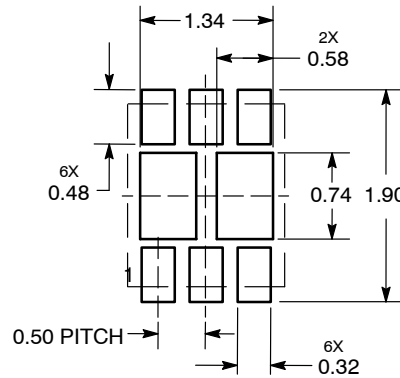

*For additional information on our Pb-Free strategy and soldering details, please download the ON Semiconductor Soldering and Mounting Techniques Reference Manual, SOLDERRM/D.

ON Semiconductor and are registered trademarks of Semiconductor Components Industries, LLC (SCILLC). SCILLC reserves the right to make changes without further notice to any products herein. SCILLC makes no warranty, representation or guarantee regarding the suitability of its products for any particular purpose, nor does SCILLC assume any liability arising out of the application or use of any product or circuit, and specifically disclaims any and all liability, including without limitation special, consequential or incidental damages. "Typical" parameters which may be provided in SCILLC data sheets and/or specifications can and do vary in different applications and actual performance may vary over time. All operating parameters, including "Typicals" must be validated for each customer application by customer's technical experts. SCILLC does not convey any license under its patent rights nor the rights of others. SCILLC products are not designed, intended, or authorized for use as components in systems intended for surgical implant into the body, or other applications intended to support or sustain life, or for any other application in which the failure of the SCILLC product could create a situation where personal injury or death may occur. Should Buyer purchase or use SCILLC products for any such unintended or unauthorized application, Buyer shall indemnify and hold SCILLC and its officers, employees, subsidiaries, affiliates, and distributors harmless against all claims, costs, damages, and expenses, and reasonable attorney fees arising out of, directly or indirectly, any claim of personal injury or death associated with such unintended or unauthorized use, even if such claim alleges that SCILLC was negligent regarding the design or manufacture of the part. SCILLC is an Equal Opportunity/Affirmative Action Employer. This literature is subject to all applicable copyright laws and is not for resale in any manner.

PUBLICATION ORDERING INFORMATION

LITERATURE FULFILLMENT:
Literature Distribution Center for ON Semiconductor
P.O. Box 5163, Denver, Colorado 80217 USA
Phone: 303-675-2175 or 800-344-3860 Toll Free USA/Canada
Fax: 303-675-2176 or 800-344-3867 Toll Free USA/Canada
Email: orderlit@onsemi.com

N. American Technical Support: 800-282-9855 Toll Free
USA/Canada
Europe, Middle East and Africa Technical Support:
Phone: 421 33 790 2910
Japan Customer Focus Center
Phone: 81-3-5773-3850

ON Semiconductor Website: www.onsemi.com
Order Literature: <http://www.onsemi.com/orderlit>

For additional information, please contact your local Sales Representative