

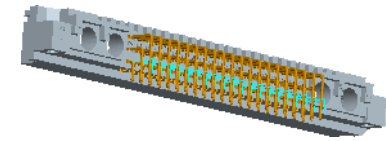

Copyright FCI.

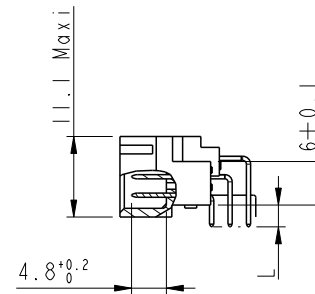

SCALE 1:1

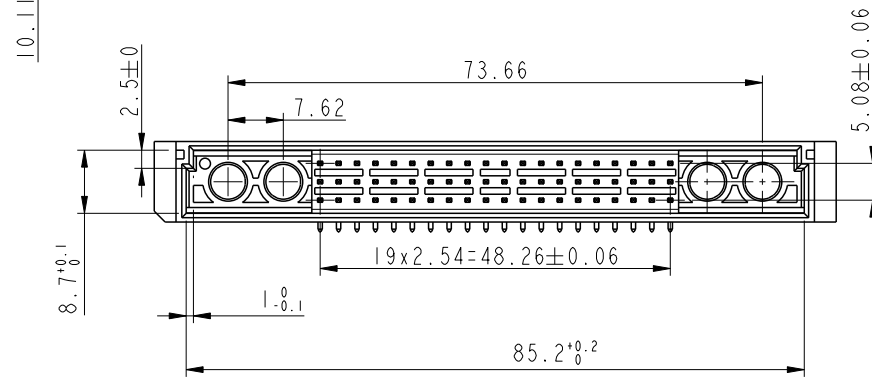
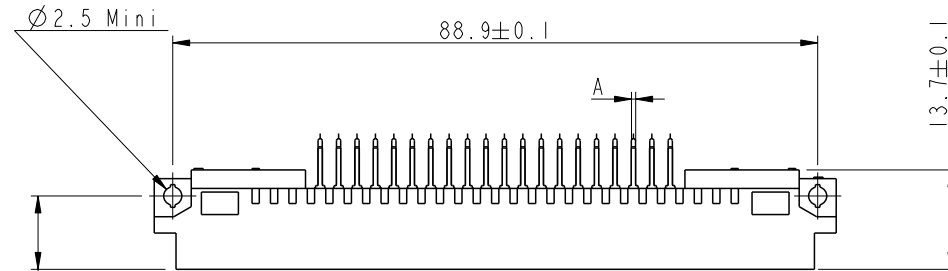
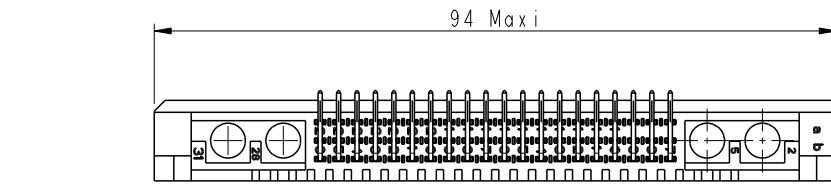
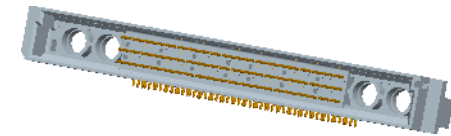

SCALE 1:1

SECTION A-A

PART-NUMBERS See Scheet 2.

GENERAL CHARACTERISTICS and ROHS INFORMATIONS
SEE DRAWING C-8609-0000A

rev	ecn no	dr	date
D	-	ROU	2002/08/30
E	LS05-001	JTA	2005/03/04
F	LS06-0097	LGO	2006/07/11
G	LS08-0169	HLE	2008/08/09
-	-	-	-
-	-	-	-

www.fciconnect.com		surface - ✓	tolerance std	projection	mm
		ISO 1302	ISO 406 ISO 1101		
		TOLERANCES UNLESS OTHERWISE SPECIFIED		size	Scale
Dr	ROUILLARD	16/09/1992	ANGULAR	A3	3:2
Eng	J. TARON	16/09/1992	LINEAR		
Chr	P. LEGARE	16/09/1992	0° ±2°		
Appr	P. LEGARE	16/09/1992	Product family	-	ECN LS08-0169
				Spec ref	-
			title		Rev.
			8609 SERIE STYLE M		G
			STANDARD MALE 3 ROW		
			dwg no	C-8609-0308	
			catalog no	8609 xxx xl 13x 7x5 EILF	sheet 1 of 2
			CUSTOMER		

REV I - 2006-04-17

PART NUMBER	8609	<input type="checkbox"/>	<input type="checkbox"/>	C1	<input type="checkbox"/>	<input type="checkbox"/>	5	<input type="checkbox"/>
PIN OUT								
rows a-b-c	-----	3	60					
rows a-c	-----	4	40					
NUMBER OF CONTACTS								
TERMINATION								
L = 2.75 ± 0.15 (.108)	A = ∅0.6 ⁰ _{-0.08}	B = ∅0.8 ⁰ _{+0.3}	13					
L = 4.15 ± 0.15 (.163)	A = 0.6X0.6	B = ∅1±0.1	23					
no option	-----	7						
with harpoons	----- for PCB thickness 1.6 mm -----	H						
DIN 41612 class 3	-----	4						
DIN 41612 class 2	-----	5						
DIN 41612 class 1	-----	6						
TERMINATION TYPE								
TIN LEAD	-----						000E1	
LEAD FREE	-----						E1LF	

PCB DRILLING
Component side

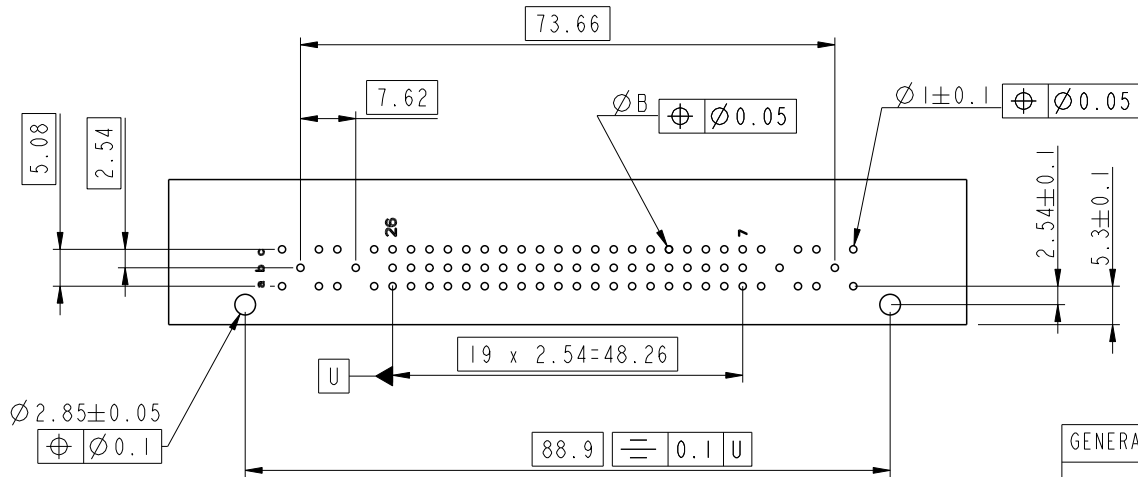

GENERAL CHARACTERISTICS AND ROHS INFORMATIONS:
SEE DRAWING C-8609-0000A

European Views

www.fciconnect.com			surface - <input checked="" type="checkbox"/>	tolerance std	projection	mm
			ISO 1302	ISO 406 ISO 1101		
			TOLERANCES UNLESS OTHERWISE SPECIFIED			
Dr	ROUILLARD	16/09/1992	ANGULAR	LINEAR	0.X ± 0.3	size A3 Scale 3:2
Eng	J. TARON	16/09/1992			0.XX ± 0.1	
Chr	P. LEGARE	16/09/1992	0° ± 2°		0.XXX ± 0.05	ECN LS08-0169
Appr	P. LEGARE	16/09/1992	Product family		-	Spec ref -
	title 8609 SERIE STYLE M				dwg no	Rev.
	STANDARD MALE 3 ROW				C-8609-0308	G
	catalog no 8609 xxx xl 13x 7x5 E1LF			CUSTOMER	sheet 2 of 2	

Copyright FCI.

REV 1 - 2006-04-17