

LAURA-W-PIN

~40° wide beam optimized for CREE XP-E.
Assembly with white holder, installation tape
and location pins.

TECHNICAL SPECIFICATIONS:

Dimensions	21.6 x 21.6 mm
Height	13.1 mm
Fastening	tape, pin
Colour	white
Box size	
Box weight	7.8 kg
Quantity in Box	1440 pcs
ROHS compliant	yes ⓘ



MATERIAL SPECIFICATIONS:

Component	Type	Material	Colour
LAURA-W	Lens	PMMA	clear
LAURA-PIN-XP-HLD-WHT	Holder	PC	white
ROSE-TAPE	Tape	PU tape	black

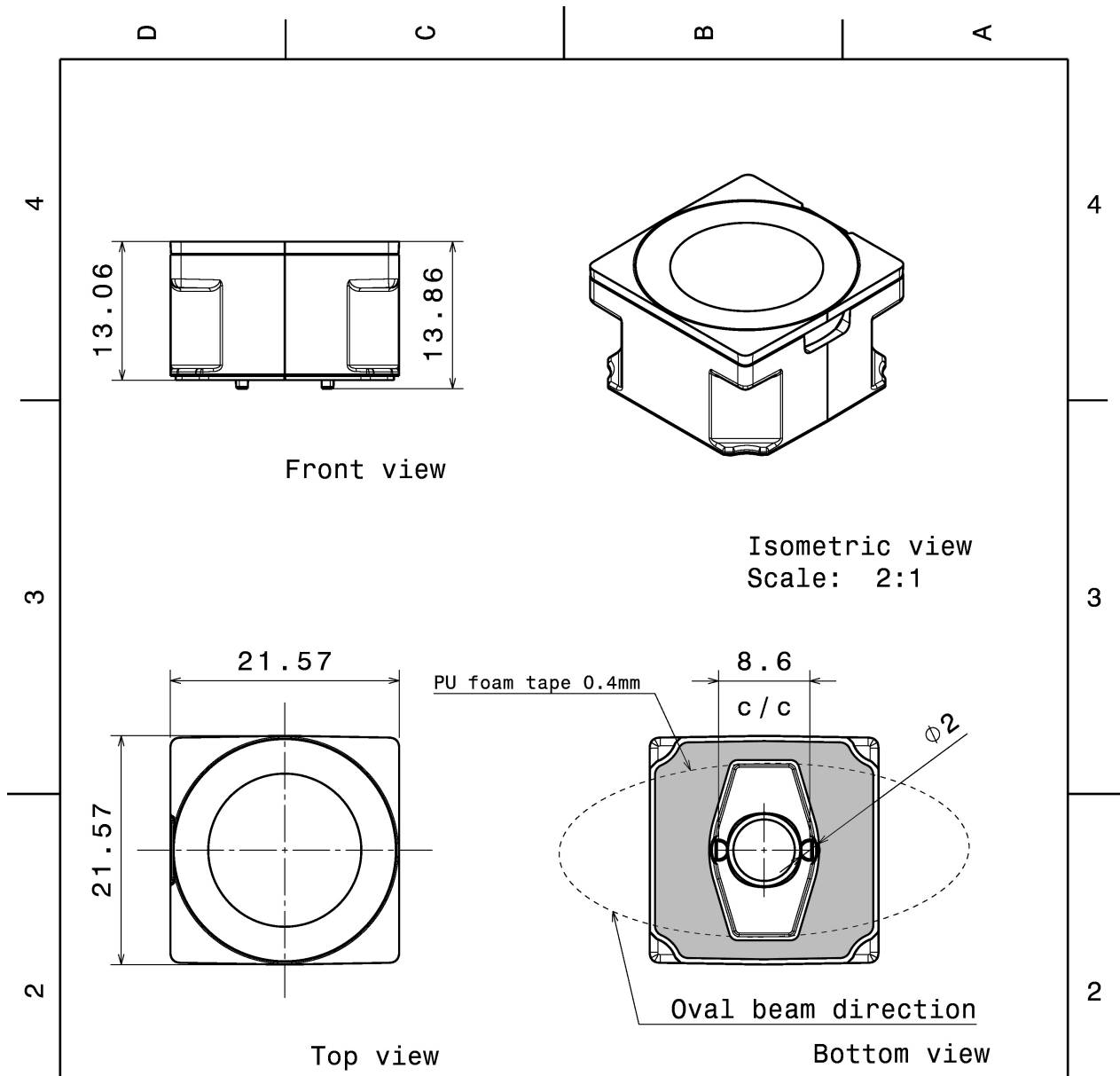

INDEX	PART NO	DESCRIPTION	MATERIAL	COLOUR
1	-	Laura-mech	PMMA	
3	C11835	LAURA-PIN-XP-HLD-WHT	PC	white

Tolerances if not otherwise shown
According to DIN ISO 2768-1
Linear measures:
Up to 30mm class M, otherwise class C.
According to DIN ISO 2768-2
Form and position: class L

LEDiL

Ledil Oy
Salorankatu 10
FIN 24240 SALO
Finland

THIRD ANGLE PROJECTION:

DRAWING TITLE
LAURA-XP-PIN-WHT assembly

This drawing is the property of LEDiL Oy. It may not be reproduced, copied or communicated without a written agreement with LEDiL Oy.

SIZE	PART NUMBER
A4	-

SCALE	2:1	WEIGHT	9 g	SHEET	1/1
-------	-----	--------	-----	-------	-----

PHOTOMETRIC DATA (MEASURED):

CREE

LED XB-D
FWHM 42.0°
Efficiency 86 %
Peak intensity 1.520 cd/lm
Required components:

CREE

LED XP-E
FWHM 47.0°
Efficiency 92 %
Peak intensity 1.700 cd/lm
Required components:

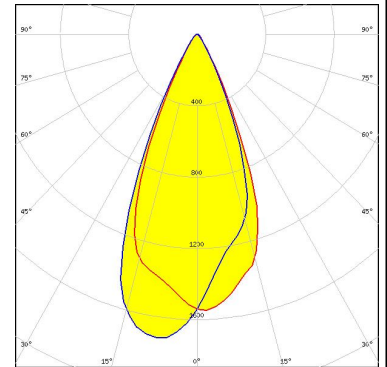

CREE

LED XP-G
FWHM 46.0°
Efficiency 91 %
Peak intensity 1.550 cd/lm
Required components:

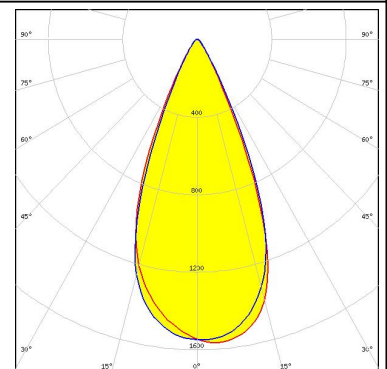

LUMILEDS

LED LUXEON Rebel
FWHM 44.0°
Efficiency 88 %
Peak intensity 1.800 cd/lm
Required components:

PHOTOMETRIC DATA (MEASURED):



LED LUXEON T
FWHM 46.0°
Efficiency 88 %
Peak intensity 1.400 cd/lm
Required components:

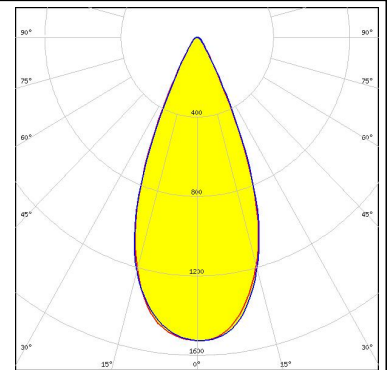

LED LUXEON Z ES
FWHM 38.0°
Efficiency 92 %
Peak intensity 2.200 cd/lm
Required components:



LED NCSxx19B
FWHM 41.0°
Efficiency 90 %
Peak intensity 1.900 cd/lm
Required components:

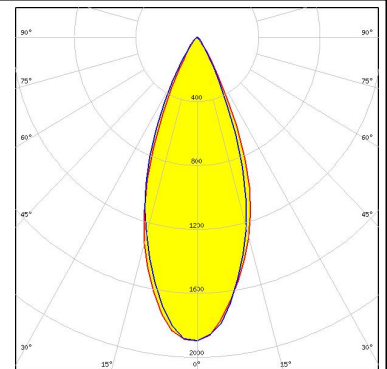
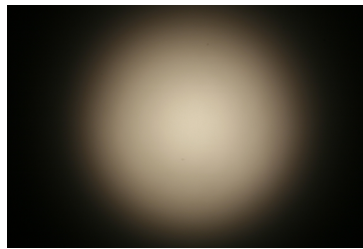

LED NF2x757D
FWHM 36.0°
Efficiency 87 %
Peak intensity 2.100 cd/lm
Required components:

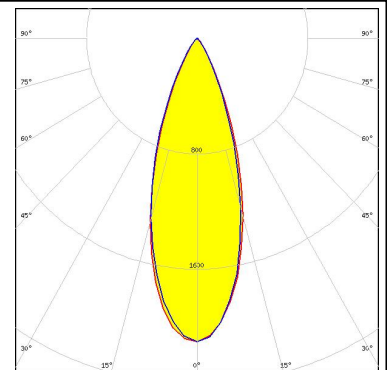
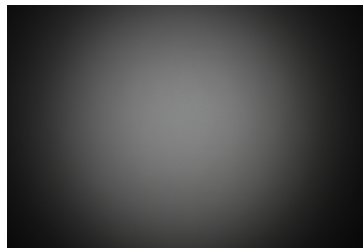

PHOTOMETRIC DATA (MEASURED):

OSRAM
Opto Semiconductors

LED Oslon Square EC
FWHM 44.0°
Efficiency 89 %
Peak intensity cd/lm
Required components:

OSRAM
Opto Semiconductors

LED Oslon SSL 150
FWHM 34.0°
Efficiency 85 %
Peak intensity cd/lm
Required components:

OSRAM
Opto Semiconductors

LED Oslon SSL 80
FWHM 43.0°
Efficiency 88 %
Peak intensity cd/lm
Required components:

PHOTOMETRIC DATA (SIMULATED):



LED XP-G3
FWHM 48.0°
Efficiency 93 %
Peak intensity 1.400 cd/lm
Required components:

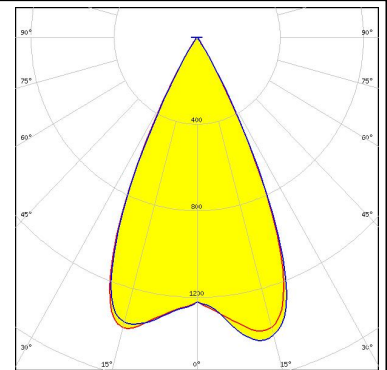
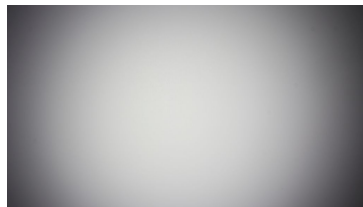

LED LUXEON H50-2
FWHM 51.0°
Efficiency 92 %
Peak intensity 1.400 cd/lm
Required components:



SEOUL SEMICONDUCTOR

LED Z5
FWHM 46.0°
Efficiency %
Peak intensity cd/lm
Required components:

GENERAL INFORMATION:

NOTE: The typical beam angle will be changed by different color, chip size and chip position tolerance. The typical total beam angle is the full angle measured where the luminous intensity is half of the peak value.

MATERIALS:

As part of our continuous research and improvement processes, and to ensure the best possible quality and availability of our products, LEDiL reserves the right to change material grades without notice.

PRODUCT DATA USER AGREEMENT AND DISCLAIMER:

The measured data in the provided downloadable LEDiL Product Datasheets and Mechanical 2D-Drawings is rounded and provided as reference for planning. LEDiL Oy's optical specifications have been verified by conducting performance testing of the products in accordance with the company's quality system. The reported data are averaged results of multiple measurements with typical variation. LEDiL Oy reserves the right to without prior notification make changes and improvements to its products.

LEDiL Oy assumes neither warranty, nor guarantee nor any other liability of any kind for the contents and correctness of the provided data. The provided data has been generated with highest diligence but the provided data may in reality not represent the complete possible variation range of all intrinsic parameters. Therefore, in certain cases a deviation from the provided data could occur.

LEDiL Oy reserves the right to undertake technical changes of its products without further notification which could lead to changes in the provided data. LEDiL Oy assumes no liability of any kind for the possible deviation from any provided data or any other damage resulting from the usage of the provided data.

The user agrees to this disclaimer and user agreement with the download or usage of the provided files.

LEDiL Oy

Joensuunkatu 13
FI-24240 SALO
Finland

LEDiL Inc.

228 West Page Street
Suite D
Sycamore IL 60178
USA

Local sales and technical support

[www.ledil.com/
where_to_buy](http://www.ledil.com/where_to_buy)

Shipping locations

Salo, Finland
Hong Kong, China

Distribution Partners

[www.ledil.com/
where_to_buy](http://www.ledil.com/where_to_buy)