

DESCRIPTION: HIGH DENSITY RIGHT ANGLE WITH FERRITE

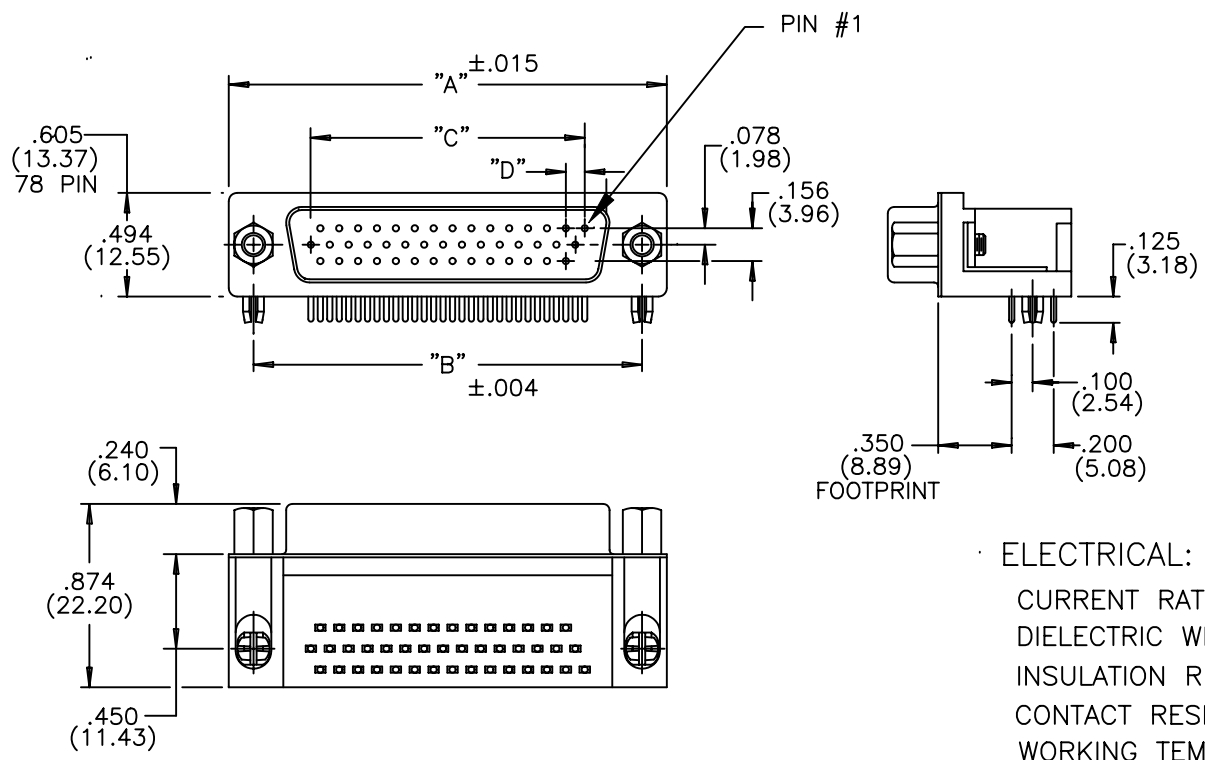

MATERIALS:

INSULATOR: PBT, UL94V-0, 230°C PROCESS TEMP.
 CHEMICAL RESISTANCE, COLOR BLACK
 SHELL: STEEL, NICKEL PLATED
 CONTACT: MALE:BRASS; FEMALE:PHOSPHOR BRONZE
 GOLD FLASH IN MATING AREA
 TIN PLATING ON TAIL ENDS
 RoHS COMPLIANT

ELECTRICAL:

CURRENT RATING: 2 AMPERES
 DIELECTRIC WITHSTANDING VOLTAGE: 1000VAC rms AT SEA LEVEL
 INSULATION RESISTANCE: 5000 MEGOHMS MIN.
 CONTACT RESISTANCE: 10 MILLIOHMS MAX.
 WORKING TEMPERATURE: -55° TO +125° C
 FERRITE SPECS: ATTENUATION - 25 OHMS MIN @ 30 Mhz,
 35 OHMS MIN @ 50 Mhz, 50 OHMS @ 100 Mhz.

194-XXX-X13LXX1

SERIES _____
 NUMBER OF CONTACTS _____
 GENDER _____
 1 = MALE
 2 = FEMALE (NO GROUND INDENTS)
 PC MOUNT _____
 3 = NICKEL SHELL _____

HARDWARE OPTIONS: _____
 17 = 4-40 INSERT WITH INSIDE GROUND STRAP
 53 = 4-40 INSERT WITH BOARD LOCKS
 56 = 4-40 STANDOFFS WITH BOARD LOCKS

PLATING: _____
 1 = GOLD FLASH

NUMBER OF CONTACTS	"A" Inch (mm)	"B" Inch (mm)	"C" Inch (mm)	"D" Inch (mm)
15	1.214 (30.84)	.984 (24.99)	.405 (10.29)	.090 (2.29)
26	1.545 (39.24)	1.312 (33.32)	.765 (19.43)	.090 (2.29)
44	2.088 (53.04)	1.852 (47.04)	1.305 (33.15)	.090 (2.29)
62	2.730 (69.34)	2.500 (63.50)	1.948 (49.47)	.095 (2.41)
78	2.635 (66.93)	2.406 (61.11)	1.805 (45.85)	.095 (2.41)

	THESE DRAWINGS AND SPECIFICATIONS ARE THE PROPERTY OF NorComp AND SHALL NOT BE REPRODUCED, COPIED OR USED AS THE BASIS FOR THE MANUFACTURE OF APPARATUS WITHOUT WRITTEN PERMISSION.		DRAWN: PAM JENKINS	DATE: 9-15-05
	<h1>NorComp</h1>			CHECKED:
SCALE:				SHEET 1 OF 1
DWG NO. 194-XXX-213LXX1				

DESCRIPTION: HIGH DENSITY RIGHT ANGLE FEMALE FOOTPRINT

78 POSITION FEMALE

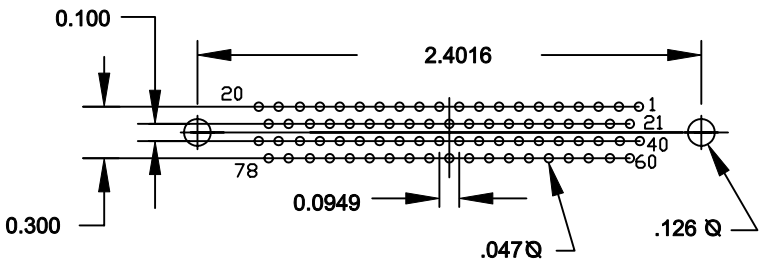

26 POSITION FEMALE

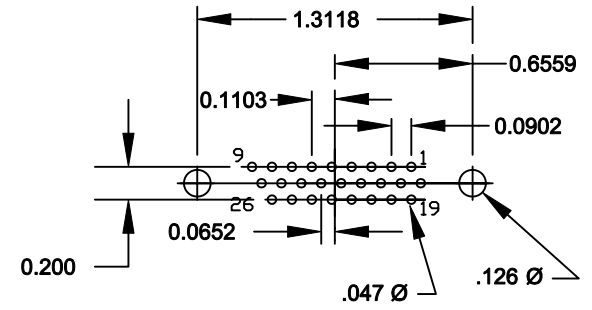

62 POSITION FEMALE

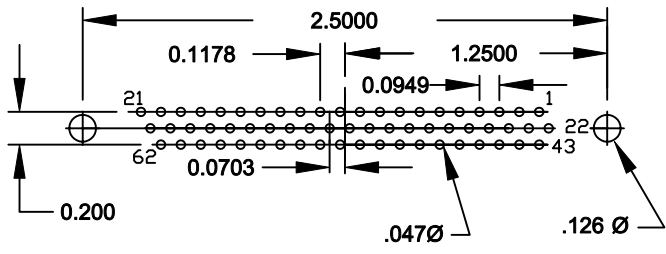

15 POSITION FEMALE

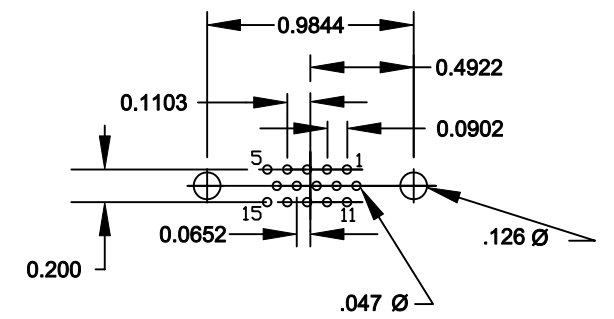

44 POSITION FEMALE

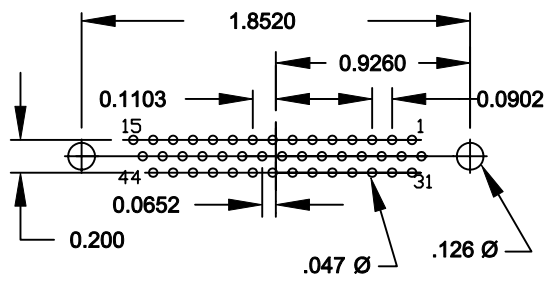

VIEWS ARE COMPONENT SIDE

	THESE DRAWINGS AND SPECIFICATIONS ARE THE PROPERTY OF NorComp AND SHALL NOT BE REPRODUCED, COPIED OR USED AS THE BASIS FOR THE MANUFACTURE OF SALE OF APPARATUS WITHOUT WRITTEN PERMISSION.		DRAWN: PAM JENKINS	DATE: 10-29-01
			CHECKED:	DATE:
<h1>NorComp</h1>		SCALE:	SHEET 1 OF 1	REV 4
		DWG NO. HIGH DENSITY RIGHT ANGLE FEMALE FOOTPRINT		