

## Description

The ZL2105 is an innovative mixed-signal power management and conversion IC that combines an integrated step-down DC-DC converter with key power and thermal management functions in a single package. The ZL2105EV2 platform allows evaluation of the features in the highly configurable ZL2105 in either stand-alone mode or via an I<sup>2</sup>C/SMBus interface.

A USB-to-SMBus adapter board can be used to connect the ZL2105EV2 board to a PC. The PMBus command set is accessed by using the Zilker Labs PowerNavigator™ evaluation software from a PC running Microsoft Windows.

## Features

- Small, compact design
- PMBus control
- Pin-strap selection for stand-alone operation
- V<sub>OUT</sub> settable from +0.6 V to +5 V
- Convenient power connection
- Onboard enable switch
- Power good indicator

## Target Specifications

This board has been designed as a buck regulator for the following conditions:

- V<sub>IN</sub> = 12 V (Board range 4.5 V to 14 V)
- V<sub>OUT</sub> = 3.3 V (Board range 0 to 5 V)
- I<sub>MAX</sub> = 3 A (Board range 0 to 3 A)
- f<sub>sw</sub> = 400 kHz
- Efficiency: 83% peak
- Output ripple: 0.5%
- Dynamic response: 3% (1–2A step, di/dt=2.5A/μs)
- Temperature: 25°C

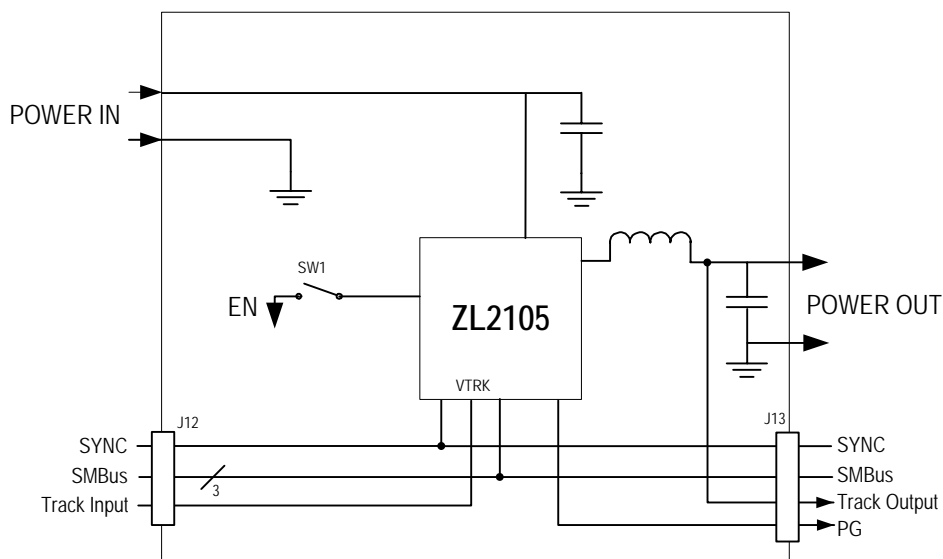

**Figure 1. ZL2105EV2 Block Diagram**

## Functional Description

---

The ZL2105EV2 provides all circuitry required to demonstrate the features of the ZL2105. The ZL2105EV2 has a functionally-optimized ZL2105 circuit layout that allows efficient operation up to the maximum output current. Power and load connections are provided through plug-in sockets.

Stand alone operation is achieved using the pin-strap settings for the device. The pin-strap settings are described in the ZL2105 data sheet [1].

The ZL2105 Evaluation Board is shown in Figure 2. The SMBus address is selectable through jumpers on the top side of the board. All power to the board (VIN and I<sup>2</sup>C bus) must be removed before changing the jumpers. The back side of the board has 0402 resistor footprints for setting the application pins using resistors.

The hardware enable function is controlled by a toggle switch on the ZL2105EV2 board. The power good (PG) LED is powered from the SMBus/I<sup>2</sup>C source; it indicates the correct state of PG when external power is applied to the ZL2105EV2 board. The right angle headers at opposite ends of the board are for connecting a USB to I<sup>2</sup>C control board or for daisy chaining of multiple evaluation boards.

Figure 3 shows the ZL2105 operational circuit. The circuit consists of the ZL2105 power conversion and management IC with its minimal component count to realize a buck converter. The board layout has been optimized for thermal performance. For thermal design considerations relating to the ZL2105, refer to Zilker Labs application note AN10[2].

Figure 5 on Page 8 illustrates the input and output power connections for the ZL2105. The optional input capacitors and output capacitors are also shown on this page.

## Operation

---

### Stand Alone Operation

The ZL2105 is easy to setup and operate. It is configured, out of the box, to provide 3.3 V at 3 A from a 12 V source. All input and output connections should be made before turning the input supply on.

When the input power supply is turned on, the ZL2105 will output the configured voltage and the load applied to VOUT+/VOUT- can be varied.

To modify the pin-strap setting of the ZL2105, input power must be turned off. The user pin-strap resistor pads are on the bottom side of the ZL2105EV2 PCB. Once the desired pin-strap settings and component changes have been applied, power can be turned on and the output can be evaluated for the newly configured mode. Refer to the ZL2105 data sheet [1] for pin-strap and resistor setting information. Refer to Figure 2 for resistor pad locations.

### PMBus Operation

The ZL2105 utilizes the PMBus protocol. The PMBus functionality can be controlled via USB from a PC running the Zilker Labs evaluation software in a Windows XP or Windows 2000/NT operating system.

Install the PowerNavigator software using the CD included in the ZL2105EV2 kit or download it from the web at [www.zilkerlabs.com](http://www.zilkerlabs.com).

For PMBus operation, connect another Zilker Labs evaluation board such as the ZL2005EV1 or the USB-to-SMBus adapter board to J12 of the ZL2105EV2 board. When using multiple evaluation boards together, verify that each device is assigned a different SMBus address. Connect the desired load and an appropriate power supply to the input. Place the ENABLE switch in “DISABLE” and turn on the power.

The evaluation software allows modification of all ZL2105 PMBus parameters. Manually configure the ZL2105 through the various

screens or load a predefined scenario from a configuration file.

Use the mouse-over pop-ups for help with PowerNavigator. Refer to Zilker Labs application note AN13 [3] for PMBus details.

The ENABLE switch can then be moved to “ENABLE” and the ZL2105 can be tested. Alternately, the PMBus ON-OFF CONFIG and OPERATION commands may be used.

## Loop Compensation Settings

By default, the ZL2105 EVB is configured for 12 V to 3.3 V conversion at 3 A. The output voltage can be changed by using the V1 and V0 resistor pads or through the use of PMBus commands. If the output voltage is set to 1V or below, the loop compensation needs to be modified. Table 1 summarizes the PID settings. This is achieved by using PMBus commands or by modifying the PowerPlan configuration file.

**Table 1. PID Settings versus Output Voltage**

V <sub>OUT</sub> Range	PID Setting
1V < V <sub>OUT</sub> ≤ 5.0V	A=5000, B=-9016, C=4170
V <sub>OUT</sub> ≤ 1V	A=10000, B=-18101, C=8324

These settings are included in the configuration file that is stored on the ZL2105 EVB and is shown here and at the end of this data sheet for reference.

For output voltages greater than 1V, the loop compensation is set as:

```
#Loop compensation for 12v:3.3v,
PID_TAPS      A=5000, B=-9016, C=4170
#NLR_CONFIG Enable,1.5%,No Outer,1.5%,3,3,0
NLR_CONFIG    0xA250
```

When the output voltage is set to 1V or less, the loop compensation should be:

```
#Loop compensation for 12V:0.8V
PID_TAPS      A=10000, B=-18101, C=8324
#NLR_CONFIG Enable,1.5%,No Outer,2%,3,3,0
NLR_CONFIG    0xA350
```

## Quick Start Guide

---

### Stand Alone Operation

1. Set ENABLE switch to “DISABLE”
2. Apply load to VOUT+/VOUT-
3. Connect power supply to VIN+/VIN- (supply turned off)
4. Turn power supply on
5. Set ENABLE switch to “ENABLE”
6. Test ZL2105 operation
7. To change hardware settings, turn input power supply OFF, modify resistor settings and then turn the input power supply ON

### USB (PMBus) Operation

1. Follow step 1 - 4 above
2. Insert the Zilker Labs Eval Kit CD
3. Connect USB-to-SMBus adapter board to J12 of ZL2105EV2
4. Connect supplied USB cable from computer to USB-to-SMBus adapter board
  - a. Upon first-time connection, the Found New Hardware Wizard will appear.
  - b. Windows XP users: Select ‘No’ at prompt to search the Internet for drivers.
  - c. Follow the steps on the screen to install the drivers from the CD.
5. Install the PowerNavigator evaluation software by running setup.exe from the PowerNavigator\_installer folder on the CD.
6. Set voltage to desired value in GUI.
7. Set ENABLE switch on EVB to “ENABLE”
8. Monitor and configure EVB using PMBus commands in the evaluation software
9. Test the ZL2105 operation using the evaluation software.

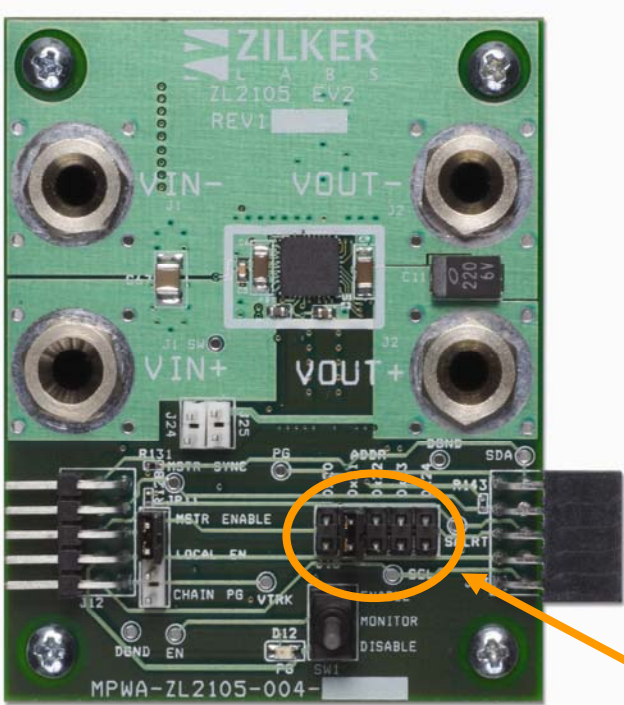

SMBus Address Jumper settings

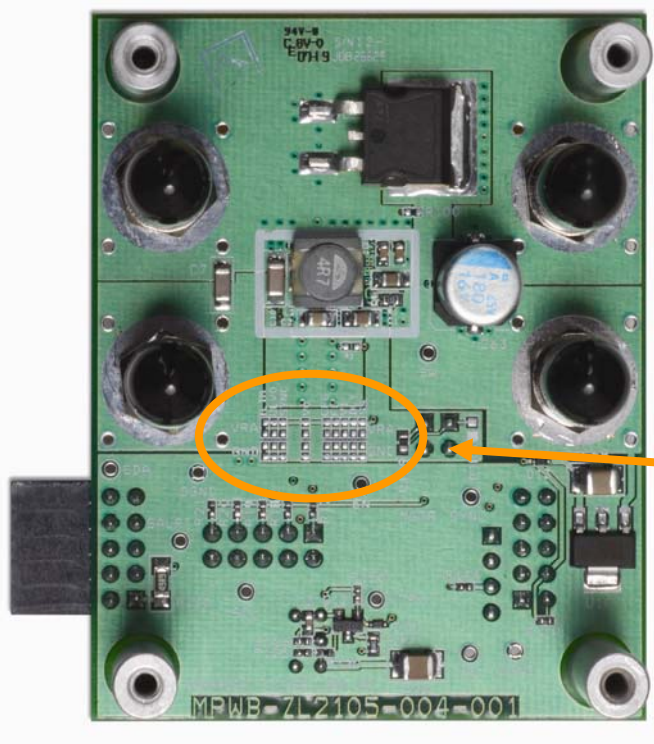

Pin-strap resistor settings

Figure 2. ZL2105EV2 Evaluation Board (Top Side and Bottom Side)

# ZL2105EV2

## Schematics

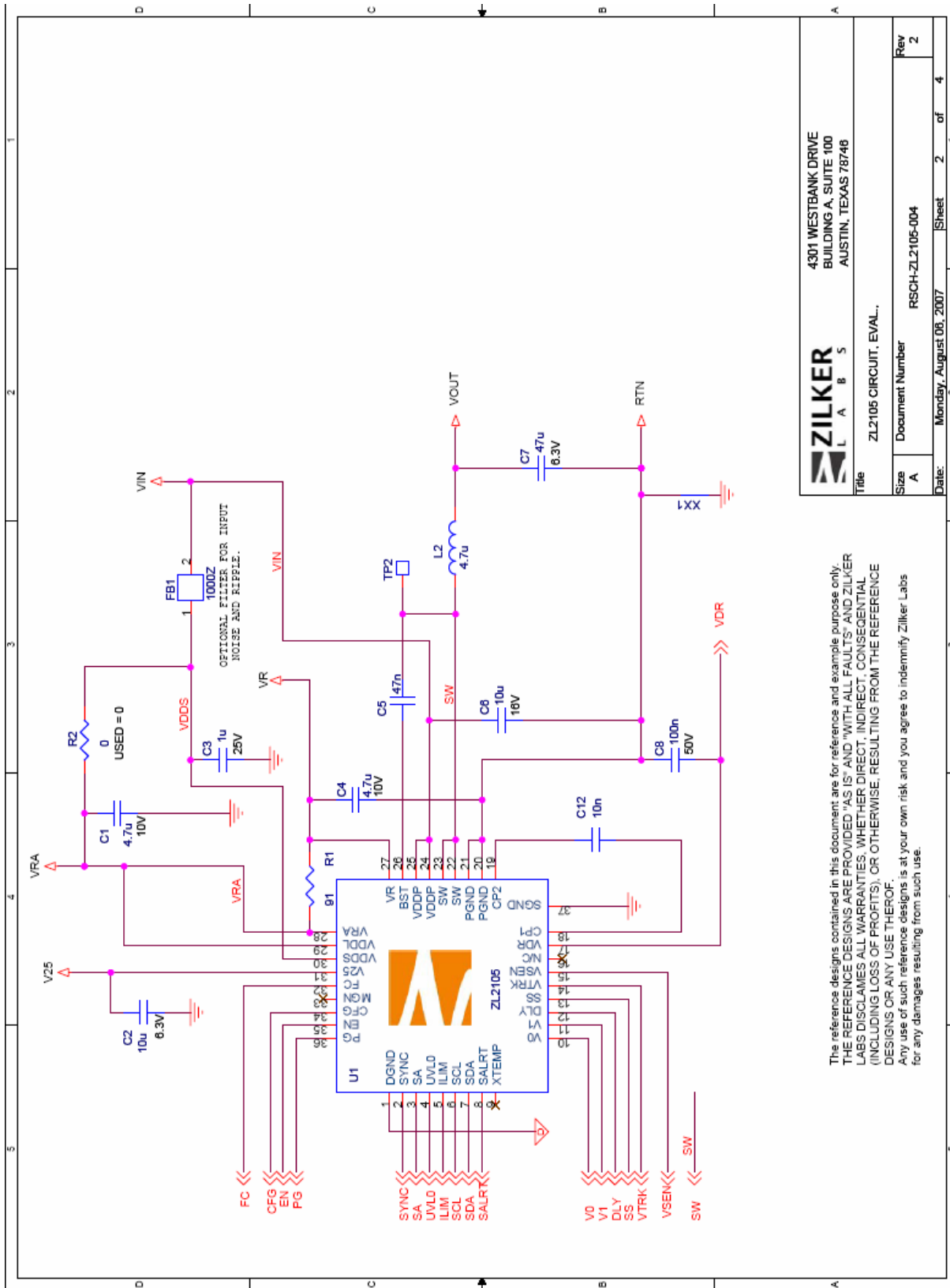
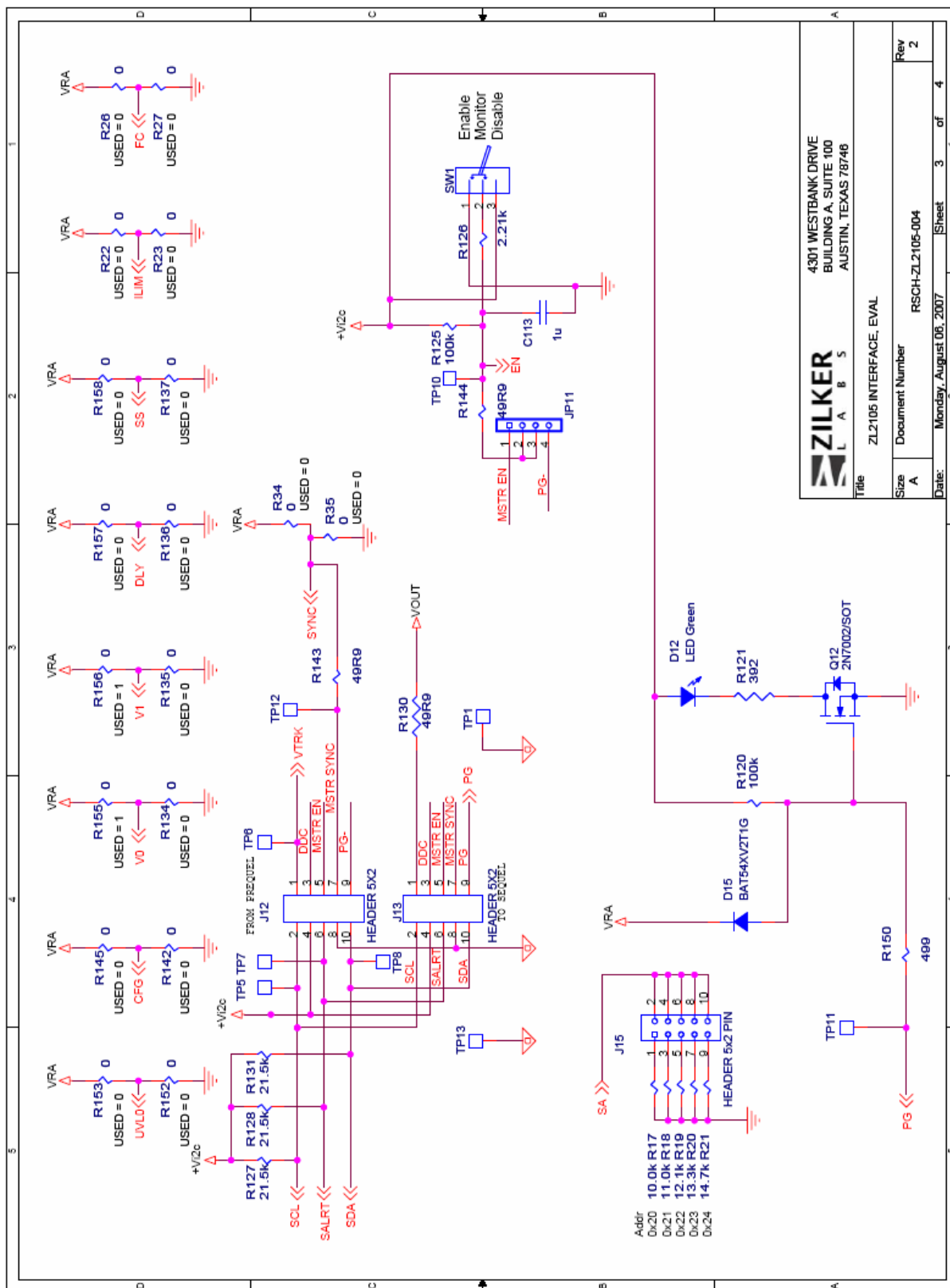

Figure 3. ZL2105EV2 Circuit

		4301 WESTBANK DRIVE BUILDING A, SUITE 100 AUSTIN, TEXAS 78748	
		Title: ZL2105 CIRCUIT, EVAL.	
Size: A	Document Number: RSCH-ZL2105-004	Rev: 2	
Date: Monday, August 06, 2007	Sheet: 2	of: 4	

The reference designs contained in this document are for reference and example purpose only. THE REFERENCE DESIGNS ARE PROVIDED "AS IS" AND "WITH ALL FAULTS" AND ZILKER LABS DISCLAIMS ALL WARRANTIES, WHETHER DIRECT, INDIRECT, CONSEQUENTIAL (INCLUDING LOSS OF PROFITS), OR OTHERWISE, RESULTING FROM THE REFERENCE DESIGNS OR ANY USE THEREOF. Any use of such reference designs is at your own risk and you agree to indemnify Zilker Labs for any damages resulting from such use.



<b>ZILKER</b> L A B S 4301 WESTBANK DRIVE BUILDING A, SUITE 100 AUSTIN, TEXAS 78746	
Title: ZL2105 INTERFACE, EVAL	
Size: A	Document Number: RSCH-ZL2105-004
Date: Monday, August 06, 2007	Sheet: 3 of 4
Rev: 2	

Figure 4. ZL2105EV2 Interface

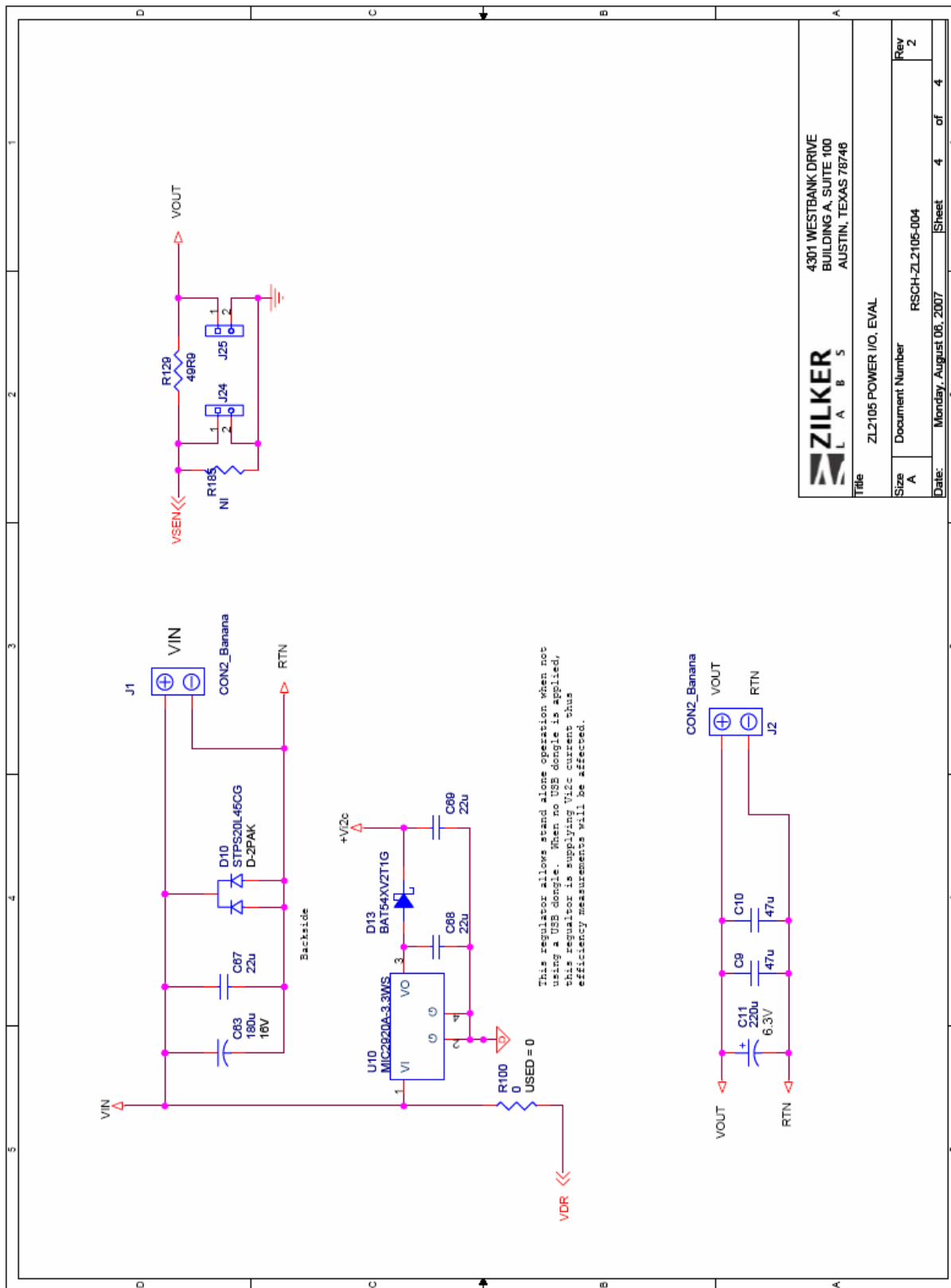

<b>ZILKER</b> L A B S		4301 WESTBANK DRIVE BUILDING A, SUITE 100 AUSTIN, TEXAS 78746	
Title: ZL2105 POWER I/O, EVAL			
Size: A	Document Number: RSCH-ZL2105-004	Rev: 2	Sheet: 4 of 4
Date: Monday, August 06, 2007			

Figure 5. ZL2105EV2 Power I/O



Board Layout – 4 Layers

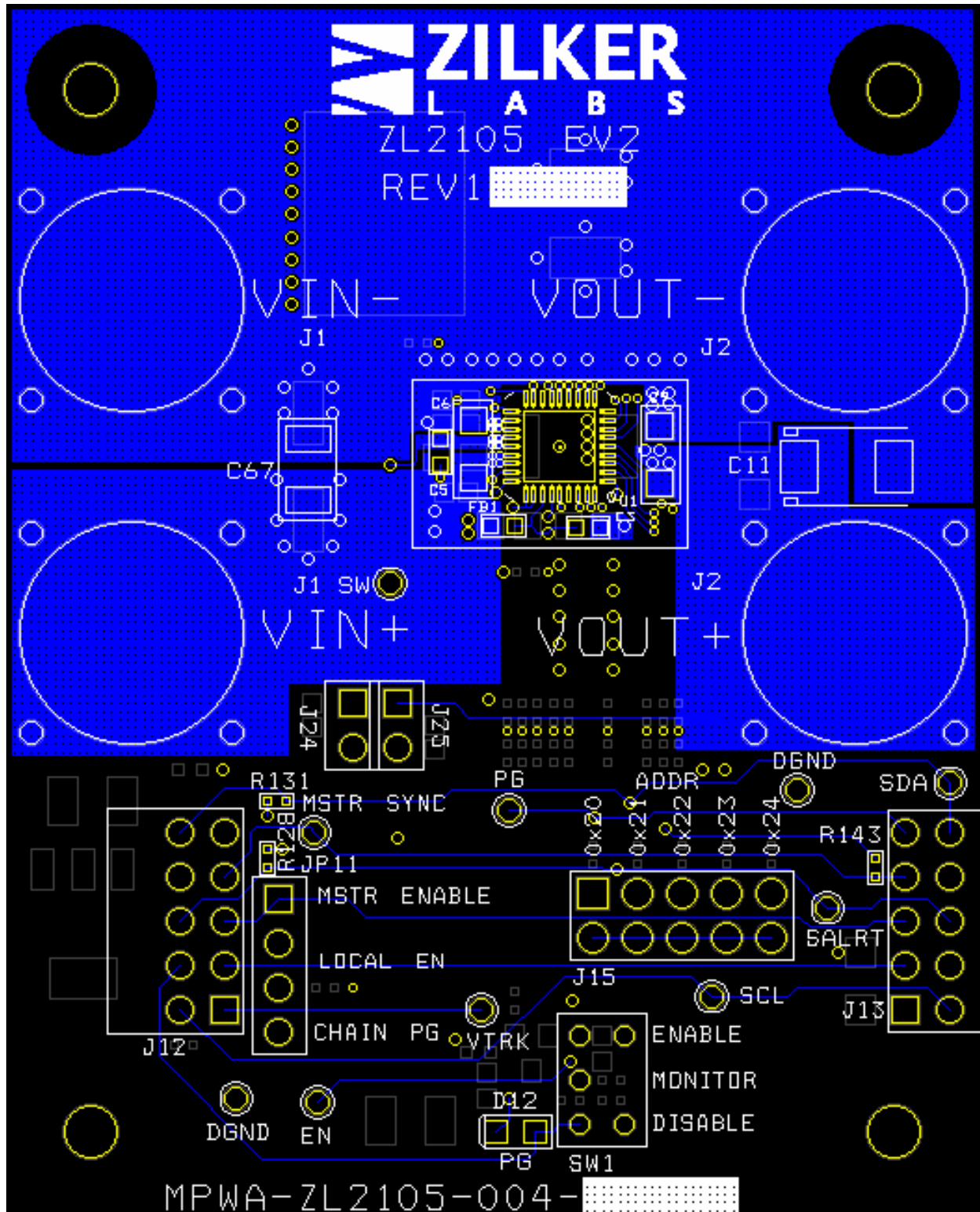

Figure 6. PCB – Top Layer

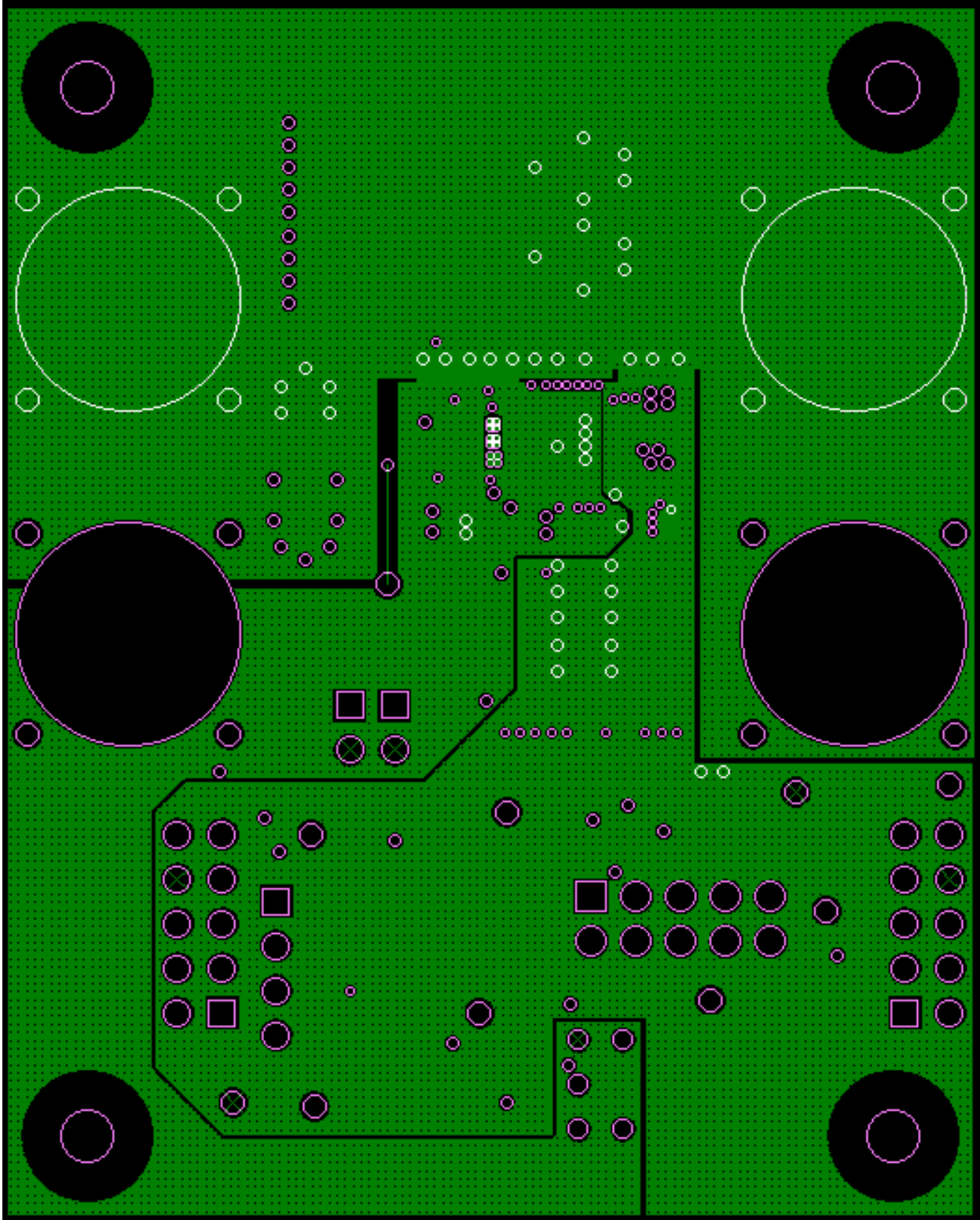

Figure 7. PCB – Inner Layer 1 (Viewed from Top)

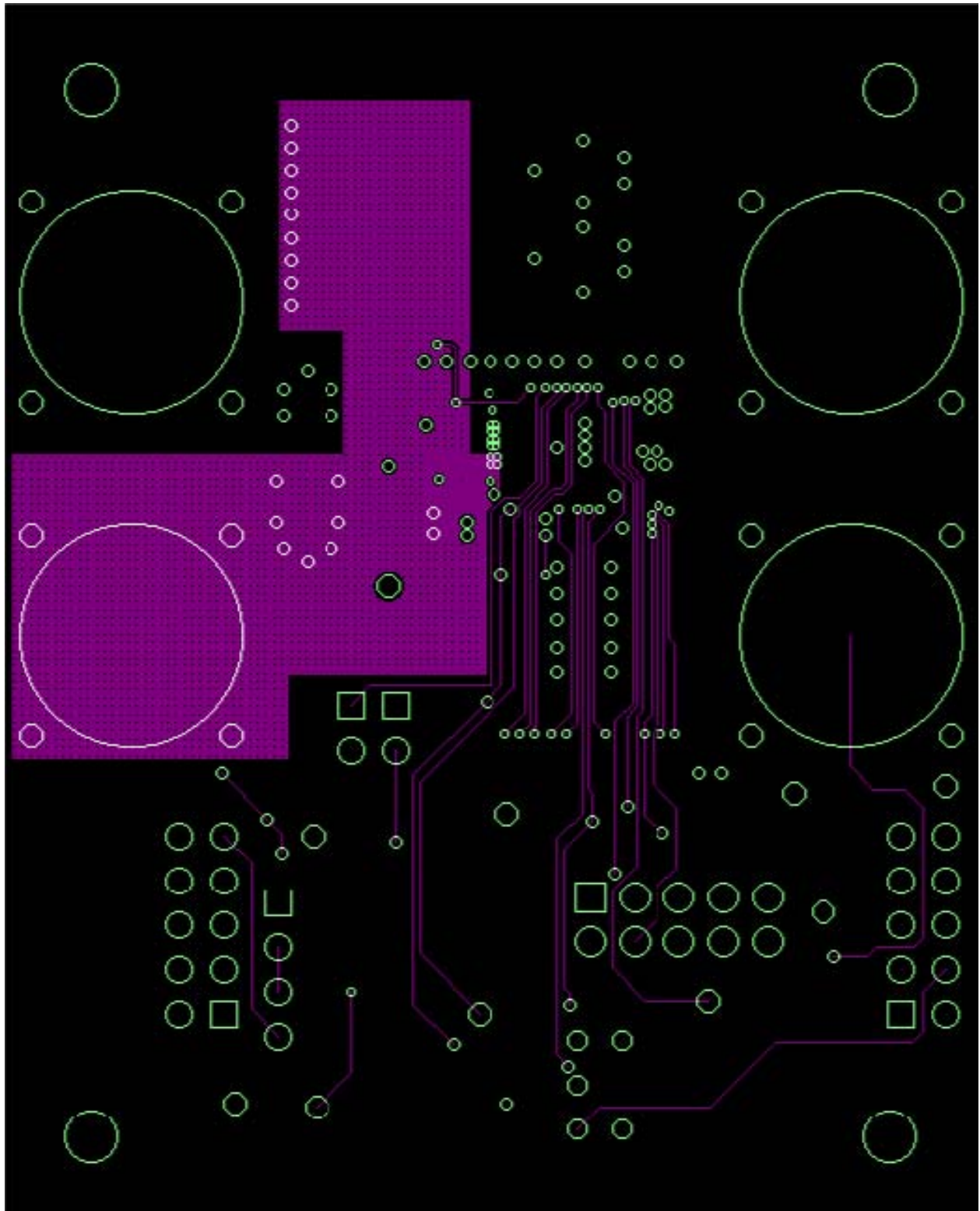

Figure 8. PCB – Inner Layer 2 (Viewed from Top)

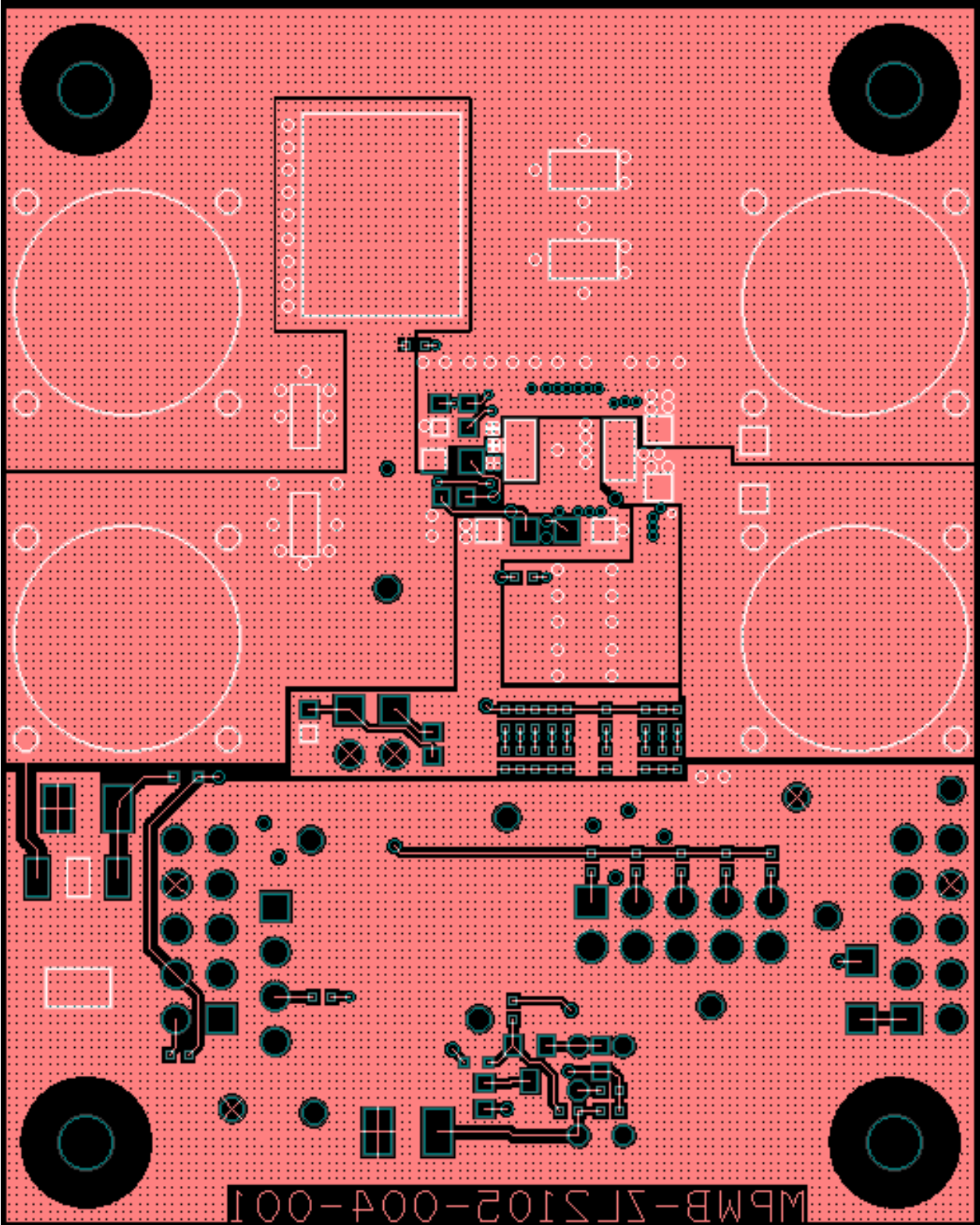

Figure 9. PCB – Bottom Layer (Viewed from Top)

### Typical Performance Data for Buck Regulator

Unless noted:  $V_{in} = 12V$ ,  $V_{out} = 3.3V$ ,  $f_{sw} = 400kHz$ ,  $T_A = +25^\circ C$

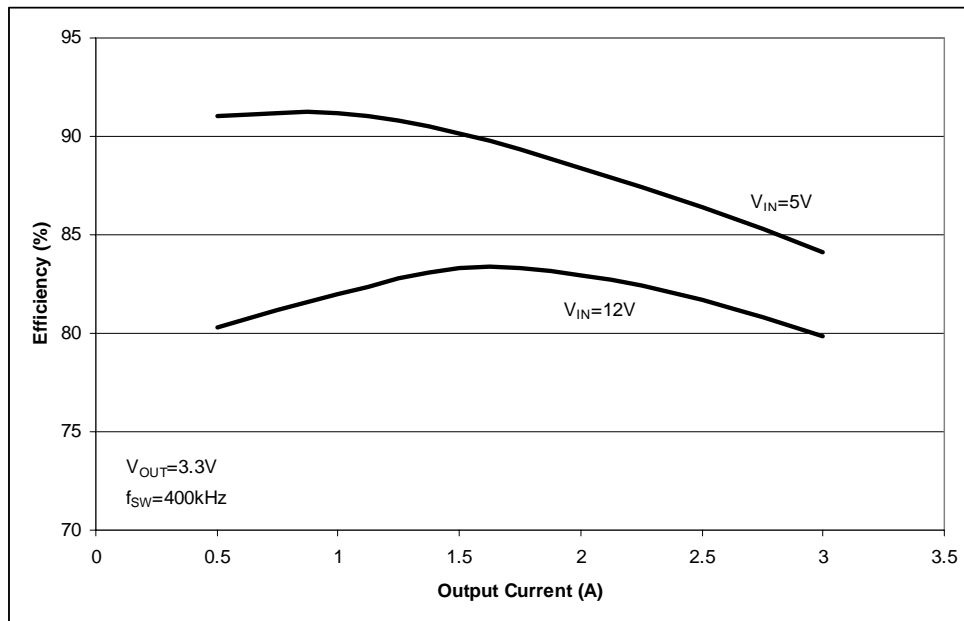

Figure 10. Measured Efficiency

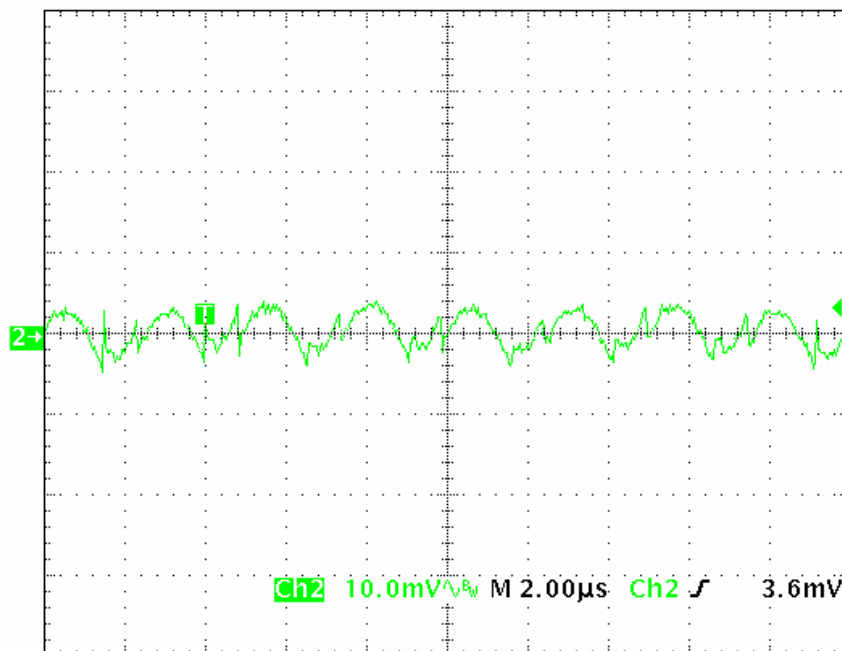

Figure 11. Ripple

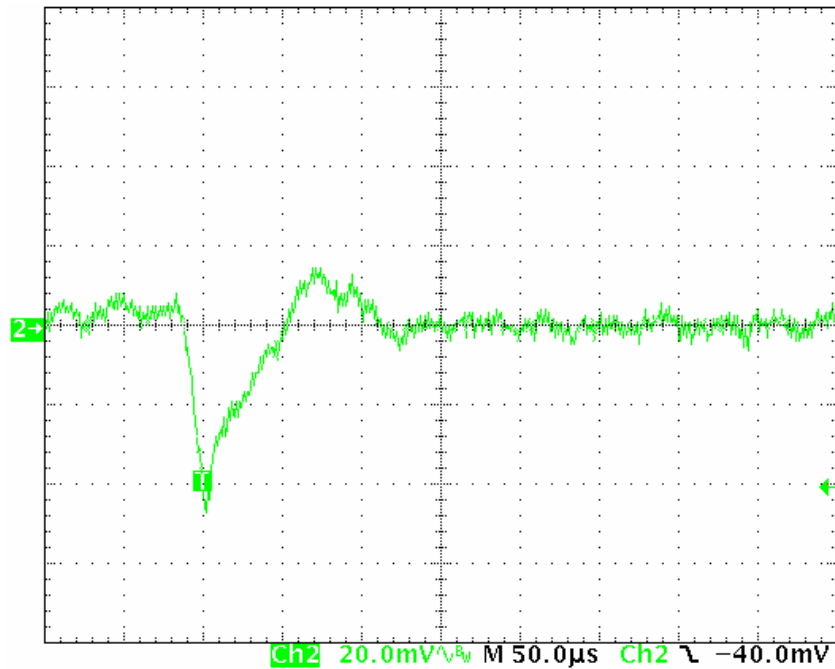

Figure 12. Dynamic Response (1 - 2A load step,  $di/dt=1A/\mu s$ )

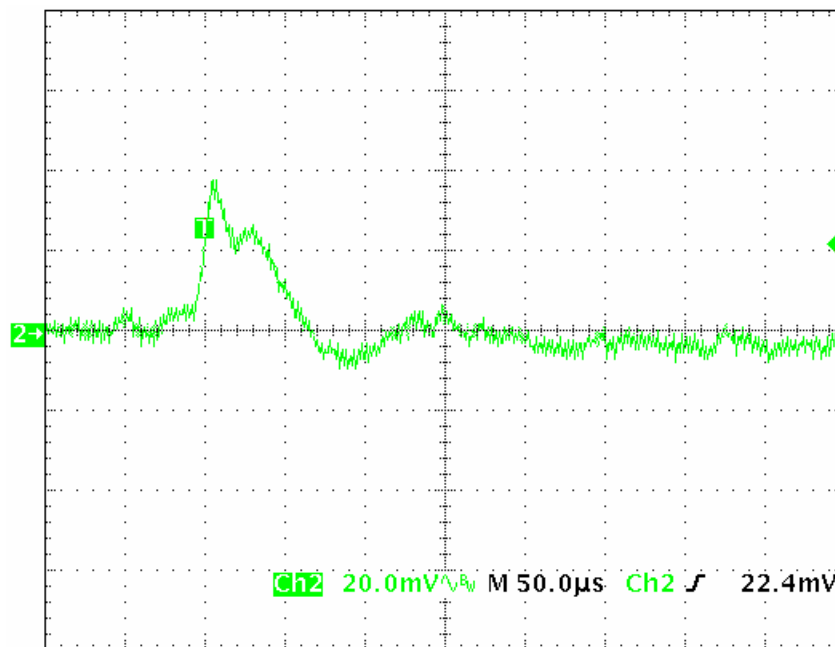

Figure 13. Dynamic Response (2 - 1A load step,  $di/dt=1A/\mu s$ )

Bill of Materials

ITEM	QTY	REFDES	VALUE	TOL	RATING	TYPE	PCB FOOTPRINT	MFR	MFR PN
1	2	C1,C4	4.7u	20%	10V	X5R	SM0805	PANASONIC-ECG	ECJ-GVB1A475M
2	1	C2	10u	20%	6.3V	X5R	SM0805	MURATA	GRM21BR60J106ME19L
3	1	C3	1u	10%	25V	X5R	SM0603	TAIYO YUDEN	TMK107BJ105KA-T
4	1	C5	47n	10%	25V	X7R	SM0603	AVX	06033C473KAT2A
5	1	C6	10u	20%	16V	X5R	SM1206	TDK	C3216X5R1C106M
6	3	C7,C9,C10	47u	20%	6.3V	X5R	SM1206	TDK	C3216X5R0J476M
7	1	C8	100n	10%	50V	X7R	SM0603	MURATA	GRM188R71H104KA93D
8	1	C11	220u	20%	6.3V	TANT	SM7343	NICHICON	F910J227MNC
9	1	C12	10n	10%	25V	X7R	SM0603	PANASONIC-ECG	ECJ-1VB1E103K
10	1	C63	180u	20%	16V	ELECT POLY	8.3X8.3_PXA_FLD	UCC	APXA160ARA181MHC0G
11	3	C67,C68,C69	22u	10%	16V	X5R	SM1210	MURATA	GRM32ER61C226KE20L
12	1	C113	1u	10%	10V	X7R	SM0603	TAIYO YUDEN	LMK107BJ105KA-T
13	1	D10	STPS20L45CG		45V		D-2PAK	ST MICROELECT	STPS20L45CG
14	1	D12	LED Green		20mA	CLR	SM0805_DIO_1C2A	CHICAGO MINIATURE	CMD17-21VGC
15	2	D13,D15	BAT54XV2T1G		30V	SCHOTTKY	SOD-523	ON SEMI	BAT54XV2T1G
16	1	FB1	1000Z	25%	50mA	MLC	SM0603	MURATA	BLM18HD102SN1D
17	1	JP11	4 PIN			SN	SIP4/100	TYCO	644456-4
18	2	J1,J2	CON2_Banana		15A		JACK_F	EMERSON	108-0740-001
19	1	J12	HEADER 5X2			SN	HDR5DUALRA100X100	SAMTEC	TSW-105-08-T-D-RA
20	1	J13	HEADER 5X2				HDRF5DUALRA100X100	SAMTEC	SSQ-105-02-T-D-RA
21	1	J15	HEADER 5x2 PIN			SN	HDR10DUAL100X100	SAMTEC	TSW-105-07-T-D
22	2	J24,J25	2 PIN			SN	SIP2/100	TYCO	644456-2
23	1	L2	4.7u	20%	3.4A	SH DRUM	IHLP_2525BD	TDK	RLF7030T-4R7M3R4
24	1	Q12	2N7002/SOT		60V	N-CH	SOT-23	ON SEMI	2N7002LT1
25	1	R1	91	1%	100mW	THK FILM	SM0603	ROHM	MCR03EZPFX91R0
27	1	R17	10.0k	1%	63mW	THK FILM	SM0402		
28	1	R18	11.0k	1%	63mW	THK FILM	SM0402		
29	1	R19	12.1k	1%	63mW	THK FILM	SM0402		
30	1	R20	13.3k	1%	63mW	THK FILM	SM0402		
31	1	R21	14.7k	1%	63mW	THK FILM	SM0402		
32	2	R120,R125	100k	1%	63mW	THK FILM	SM0402	YAGEO	RC0402FR-07100KL
33	1	R121	392	1%	100mW	THK FILM	SM0603	YAGEO	RC0603FR-07392RL
34	1	R126	2.21k	1%	63mW	THK FILM	SM0402	YAGEO	RC0402FR-072K21L
35	3	R127,R128,R131	21.5k	1%	63mW	THK FILM	SM0402		
36	1	R129	49R9	1%	100mW	THK FILM	SM0603	ROHM	MCR03EZPFX49R9
37	1	R130	49R9	1%	250mW	THK FILM	SM1206	YAGEO	RC1206FR-0749R9L
38	2	R143,R144	49R9	1%	63mW	THK FILM	SM0402	YAGEO	RC0402FR-0749R9L
39	1	R150	499	1%	63mW	THK FILM	SM0402	YAGEO	RC0402FR-07499L
40	2	R155,R156	0	5%	63mW	THK FILM	SM0402	YAGEO	RC0402JR-070RL
42	1	SW1	SW_SPDT				SW_TOG_SPDT	NKK	G13AP
44	1	U1	ZL2105		3A		MLF36_6X6BX	ZILKER LABS INC	ZL2105ALNFT
45	1	U10	MIC2920A-3.3WS		400mA		SOT223_1234_FLD	MICREL	MIC2920A-3.3WS
47	2	XX8,XX9					SHUNT_HDR_WITH_TAB	TYCO	881545-2
48	4	XX20,XX21,XX22,XX23					STANDOFF_4-40		
49	4	XX24,XX25,XX26,XX27				PHL	SCREW_4-40	BUILDING FASTENERS	PMS 440 0025 PH
50	4	XX30,XX31,XX32,XX33					CAP_MOLDED.25ID	CAPLUGS	VC-234-8
51	1	XX34	PCB				BDOTLN3.0HX4.0L	ZILKER LABS INC	MPWB-ZL2105-004
NOT INSTALLED:									
26	18	R2,R22,R23,R26,R27,R34,R35,R100,R134,R135,R136,R137,R142,R145,R152,R153,R157,R158	0	5%	63mW	THK FILM	SM0402	YAGEO	RC0402JR-070RL
41	1	R185	NI	1%	100mW	THK FILM	SM0603		
43	10	TP1,TP2,TP5,TP6,TP7,TP8,TP10,TP11,TP12,TP13	T POINT S				TP_036H_REV1		
46	1	XX1	TIEPT/10WIDE				TIEPT/10WIDE		

## Default Configuration Text

---

The following text is loaded into the ZL2105EV2 as default settings. Each PMBus command is loaded via the ZL2105EV2 interface software. The # symbol is used for a comment line.

```
#ZL2105-002-DB08
#NOTE: This file is intended for the Rev. 1 ZL2105-EV2 with L=4.7uH,
Co=3x(47uF/2.5mohm)+(220uF/250mohm)

#Configuration File Format:
#PMBus Command <tab> Hex Value

#Erase user store & default store
RESTORE_FACTORY
STORE_USER_ALL
STORE_DEFAULT_ALL

#RESPONSES
#low FET not enabled for output OV and UV count to 2
OVUV_CONFIG 0x01

#LIMITS
VIN_UV_FAULT_LIMIT 4.5

#Set output peak/valley current protection to 4.0 to -4.0A
IOUT_OC_FAULT_LIMIT 4
IOUT_UC_FAULT_LIMIT -4

#Set output average current protection to 3.3 to -3.3A
IOUT_AVG_OC_FAULT_LIMIT 3.3
IOUT_AVG_UC_FAULT_LIMIT -3.3

#SETTINGS
#Set Vout to 3.3V
VOUT_COMMAND 3.30000

#Set IOUT_SCALE to 151mOhms
IOUT_SCALE 151

#Set IOUT_OFFSET to -0.4A
IOUT_CAL_OFFSET -0.4A

#Use Rds(on) internal current sense method with internal tempco sensor, delay 512ns, 3 counts
MFR_CONFIG 0x8100

#Set temperature compensation at 400ppm/ C internal temp sensor
TEMPCO_CONFIG 0x04

#Set deadtime to 0ns H-L min dynamic and 16ns L-H fixed
DEADTIME_CONFIG 0x0086
DEADTIME 0x0010

#Loop compensation for 12v:3.3v, ~100mv peak under 1-2A transient @ 2.5A/us, with NLR.
PID_TAPS A=5000, B=-9016, C=4170
#NLR_CONFIG Enable,1.5%,No Outer,1.5%,3,3,0
NLR_CONFIG 0xA250

#Loop compensation for 12V:0.8V, ~20kHz BW, ~60deg PM, ~30mv peak under 0.5A step
#PID_TAPS A=10000, B=-18101, C=8324
#NLR_CONFIG Enable,1.5%,No Outer,2%,3,3,0
NLR_CONFIG 0xA350

STORE_DEFAULT_ALL
RESTORE_DEFAULT_ALL
```



**References**

---

- [1] *ZL2105 Data Sheet*, Zilker Labs, Inc., 2008.
- [2] AN10 – *ZL2005 and ZL2105 Thermal and Layout Guideline*, Zilker Labs, Inc., 2006.
- [3] AN13 – *PMBus™ Command Set*, Zilker Labs, Inc., 2007.

**Ordering Information**

---

<b>Orderable Part Number</b>	<b>Description</b>
ZL2105EVK2	ZL2105 Evaluation Kit, one channel
ZL2105EV2	ZL2105 Evaluation board only

**Revision History**

---

<b>Date</b>	<b>Rev. #</b>	
1-22-08	1.0	Initial Release based on ZL2105EV1 data sheet



**Zilker Labs, Inc.  
4301 Westbank Drive  
Building A-100  
Austin, TX 78746**

**Tel: 512-382-8300**

**Fax: 512-382-8329**

[www.zilkerlabs.com](http://www.zilkerlabs.com)

© 2008, Zilker Labs, Inc. All rights reserved. Zilker Labs, Digital-DC and the Zilker Labs Logo are trademarks of Zilker Labs, Inc. All other products or brand names mentioned herein are trademarks of their respective holders.

Pricing, specifications and availability are subject to change without notice. Please see [www.zilkerlabs.com](http://www.zilkerlabs.com) for updated information. This product is not intended for use in connection with any high-risk activity, including without limitation, air travel, life critical medical operations, nuclear facilities or equipment, or the like.

The reference designs contained in this document are for reference and example purposes only. THE REFERENCE DESIGNS ARE PROVIDED "AS IS" AND "WITH ALL FAULTS" AND ZILKER LABS DISCLAIMS ALL WARRANTIES, WHETHER EXPRESS OR IMPLIED. ZILKER LABS SHALL NOT BE LIABLE FOR ANY DAMAGES, WHETHER DIRECT, INDIRECT, CONSEQUENTIAL (INCLUDING LOSS OF PROFITS), OR OTHERWISE, RESULTING FROM THE REFERENCE DESIGNS OR ANY USE THEREOF. Any use of such reference designs is at your own risk and you agree to indemnify Zilker Labs for any damages resulting from such use.