

**ARM[®] Cortex[®]-M
32-bit Microcontroller**

**NuMicro[®] Family
NuTiny-SDK-M0564
User Manual**

The information described in this document is the exclusive intellectual property of Nuvoton Technology Corporation and shall not be reproduced without permission from Nuvoton.

Nuvoton is providing this document only for reference purposes of NuMicro microcontroller based system design. Nuvoton assumes no responsibility for errors or omissions.

All data and specifications are subject to change without notice.

For additional information or questions, please contact: Nuvoton Technology Corporation.

www.nuvoton.com

Table of Contents

1 OVERVIEW 4

2 NUTINY-SDK-M0564 INTRODUCTION..... 5

 2.1 NuTiny -SDK-M0564 Jumper Description 6

 2.1.1 Power Setting6

 2.1.2 Debug Connector6

 2.1.3 USB Connector6

 2.1.4 Extended Connector6

 2.1.5 Reset Button.....6

 2.1.6 Power Connector6

 2.1.7 Virtual COM Port Function Switch6

 2.2 Pin Assignment for Extended Connector 8

 2.3 NuTiny-SDK-M0564 PCB Placement.....24

3 How to Start NuTiny-SDK-M0564 on the Keil μ Vision[®] IDE..... 25

 3.1 Keil uVision[®] IDE Software Download and Install25

 3.2 Nuvoton Nu-Link Driver Download and Install25

 3.3 Hardware Setup.....25

 3.4 Example Program.....26

4 How to Start NuTiny-SDK-M0564 on the IAR Embedded Workbench 27

 4.1 IAR Embedded Workbench Software Download and Install27

 4.2 Nuvoton Nu-Link Driver Download and Install27

 4.3 Hardware Setup.....27

 4.4 Example Program.....28

5 Starting to Use Nu-Link-Me 3.0 VCOM Function..... 29

 5.1 Downloading and Installing VCOM Driver29

 5.2 VCOM Mode Setting on NuTiny-SDK-M0564.....30

 5.3 Setup on the Development Tool.....30

 5.3.1 Check the Using UART on the Keil μ Vision[®] IDE..... 30

 5.3.2 Check the Target Device and Debug Setting 31

 5.3.3 Build and Download Code to NuTiny-SDK-M0564 33

 5.3.4 Open the Serial Port Terminal 33

 5.3.5 Reset Chip 33

6 NuTiny-SDK-M0564 Schematic..... 35

 6.1 NuTiny-EVB-M0564 Schematic35

6.2 Nu-Link-Me V3.0 Schematic36
7 REVISION HISTORY 37

1 OVERVIEW

NuTiny-SDK-M0564 is the specific development tool for NuMicro® M0564 series. Users can use NuTiny-SDK-M0564 to develop and verify the application program easily.

NuTiny-SDK-M0564 includes two portions. One is NuTiny-EVB-M0564 and the other is Nu-Link-Me. NuTiny-EVB-M0564 is the evaluation board and Nu-Link-Me is its Debug Adaptor. Thus, users do not need other additional ICE or debug equipments.

2 NUTINY-SDK-M0564 INTRODUCTION

NuTiny-SDK-M0564 uses the M0564VG4AE as the target microcontroller. Figure 2-1 NuTiny-SDK-M0564 (PCB Board) Figure 2-1 is NuTiny-SDK-M0564 for M0564 series, the left portion is called NuTiny-EVB-M0564 and the right portion is Debug Adaptor called Nu-Link-Me.

NuTiny-EVB-M0564 is similar to other development boards. Users can use it to develop and verify applications to emulate the real behavior. The on board chip covers M0564 series features. The NuTiny-EVB-M0564 can be a real system controller to design users' target systems.

Nu-Link-Me is a Debug Adaptor. The Nu-Link-Me Debug Adaptor connects your PC's USB port to your target system (via Serial Wired Debug Port) and allows you to program and debug embedded programs on the target hardware. The Nu-Link-Me V3.0 also supports VCOM function, which gives users more flexibility when debug. To use Nu-Link-Me Debug adaptor with IAR or Keil, please refer to "Nuvoton NuMicro® IAR ICE driver user manual" or Nuvoton NuMicro® Keil ICE driver user manual" in detail. These two documents will be stored in the local hard disk when the user installs each driver. To use Nu-Link-Me 3.0 VCOM function, please refer to Chapter 5.

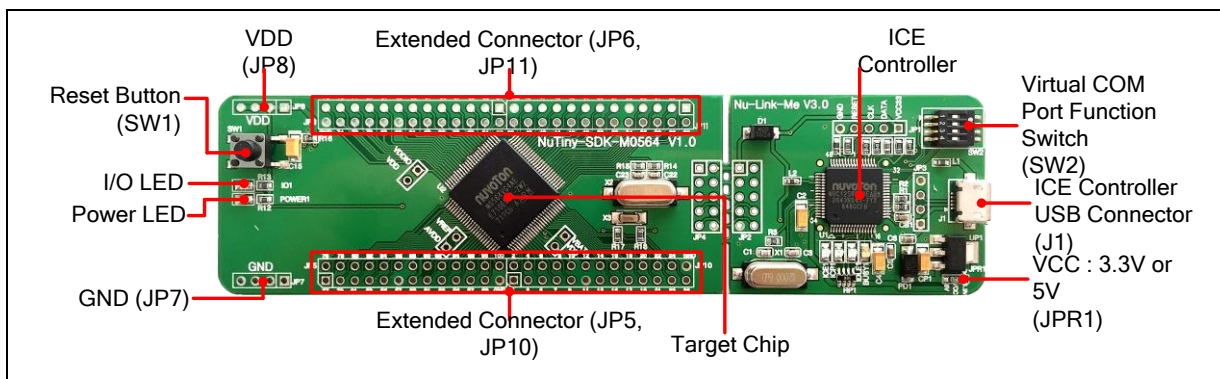

Figure 2-1 NuTiny-SDK-M0564 (PCB Board)

2.1 NuTiny -SDK-M0564 Jumper Description

2.1.1 Power Setting

- JP8: V_{DD} Voltage connector in NuTiny-EVB-M0564
- J1: USB port in Nu-Link-Me
- JPR1: Select 5.0V or 3.3V for system power

Model	JPR1	JP8 V_{DD}	J1 ICE USB Port	MCU Voltage
Model 1	Select 3.3V (Default)	DC 3.3V Output	Connect to PC	DC 3.3V
Model 2	Select 5.0V	DC 5.0V Output	Connect to PC	DC 5.0V
Model 3	Select 3.3V or 5.0V	DC 2.5V ~ 5.0V Input	Connect to PC	Voltage by JP8 Input
Model 4*	X	DC 2.5V ~ 5.0V Input	X	Voltage by JP8 Input

X: Unused.

Note*: Need to separate NuTiny-EVB-M0564 and Nu-Link-Me.

2.1.2 Debug Connector

- JP4: Connector in target board (NuTiny-EVB-M0564) for connecting with Nuvoton ICE adaptor (Nu-Link-Me)
- JP2: Connector in ICE adaptor (Nu-Link-Me) for connecting with a target board (NuTiny-EVB-M0564)

2.1.3 USB Connector

- J1: Micro USB Connector in Nu-Link-Me connected to a PC USB port

2.1.4 Extended Connector

- JP5, JP6, JP10, and JP11: Show all chip pins in NuTiny-EVB-M0564

2.1.5 Reset Button

- SW1: Reset button in NuTiny-EVB-M0564

2.1.6 Power Connector

- JP8: V_{DD} connector in NuTiny-EVB-M0564
- JP7: GND connector in NuTiny-EVB-M0564

2.1.7 Virtual COM Port Function Switch

- **SW2**: Switch SW2 on/off before power on to enable/disable VCOM function. SW2 connects pin 8(PD.0/RXD) and pin 15(PD.1/TXD) in NuTiny-EVB-M0564 with pin 22(PB.1/TXD) and pin 21(PB.0/RXD) in Nuvoton ICE adaptor (Nu-Link-Me V3.0). SW2 connects pin 30(VCOM) in Nuvoton ICE adaptor (Nu-Link-Me V3.0) to GND to enable VCOM

function.

Switch Pin Number	Disable VCOM Mode	Enable VCOM Mode
1	Off	On
2	Off	On
3	Off	On
4	Off	On

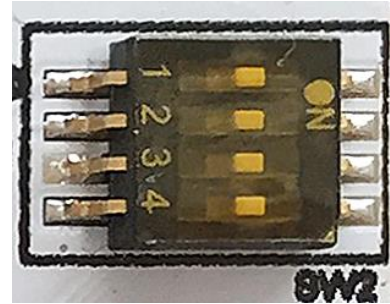

X: Unused.

2.2 Pin Assignment for Extended Connector

NuTiny-EVB-M0564 provides M0564VG4AE on board and the extended connector for LQFP100-pin. Table 2-1 is the pin assignment for M0564VG4AE.

Pin No.	Pin Name	Type	Description
1	PB.13	I/O	General purpose digital I/O pin.
	ADC0_CH10	A	ADC0 channel 10 analog input.
2	PB.14	I/O	General purpose digital I/O pin.
	ADC0_CH11	A	ADC0 channel 11 analog input.
3	PB.15	I/O	General purpose digital I/O pin.
	ADC0_CH12	A	ADC0 channel 12 analog input.
	ACMP0_P3	A	Analog comparator 0 positive input 3 pin.
	EBI_nCS1	O	EBI chip select 1 output pin.
4	PB.5	I/O	General purpose digital I/O pin.
	ADC0_CH13	A	ADC0 channel 13 analog input.
	SPI0_MOSI	I/O	SPI0 MOSI (Master Out, Slave In) pin.
	SPI1_MOSI	I/O	SPI1 MOSI (Master Out, Slave In) pin.
	ACMP0_P2	A	Analog comparator 0 positive input 2 pin.
	SC1_RST	O	Smart Card 1 reset pin.
	EBI_AD6	I/O	EBI address/data bus bit 6.
5	PB.6	I/O	General purpose digital I/O pin.
	ADC0_CH14	A	ADC0 channel 14 analog input.
	SPI0_MISO	I/O	SPI0 MISO (Master In, Slave Out) pin.
	SPI1_MISO	I/O	SPI1 MISO (Master In, Slave Out) pin.
	ACMP0_P1	A	Analog comparator 0 positive input 1 pin.
	SC1_PWR	O	Smart Card 1 power pin.
	EBI_AD5	I/O	EBI address/data bus bit 5.
6	PB.7	I/O	General purpose digital I/O pin.
	ADC0_CH15	A	ADC0 channel 15 analog input.
	SPI0_CLK	I/O	SPI0 serial clock pin.
	SPI1_CLK	I/O	SPI1 serial clock pin.
	USCI2_CTL1	I/O	USCI2 control 1 pin.
	ACMP0_P0	A	Analog comparator 0 positive input 0 pin.
	SC1_DAT	I/O	Smart Card 1 data pin.

Pin No.	Pin Name	Type	Description
	EBI_AD4	I/O	EBI address/data bus bit 4.
7	nRESET	I	External reset input: active LOW, with an internal pull-up. Set this pin low reset to initial state.
8	PD.0	I/O	General purpose digital I/O pin.
	SPI0_I2SMCLK	I/O	SPI0 I2S master clock output pin
	SPI1_I2SMCLK	I/O	SPI1 I2S master clock output pin
	UART0_RXD	I	UART0 data receiver input pin.
	USCI2_CTL0	I/O	USCI2 control 0 pin.
	ACMP1_N	A	Analog comparator 1 negative input pin.
	SC1_CLK	O	Smart Card 1 clock pin.
	INT3	I	External interrupt 3 input pin.
9	AV _{SS}	P	Ground pin for analog circuit.
10	V _{DD}	P	Power supply for I/O ports and LDO source for internal PLL and digital circuit.
11	V _{SS}	P	Ground pin for digital circuit.
12	PC.8	I/O	General purpose digital I/O pin.
	ADC0_CH16	A	ADC0 channel 16 analog input.
	UART0_nRTS	O	UART0 request to Send output pin.
13	PD.8	I/O	General purpose digital I/O pin.
	ADC0_CH17	A	ADC0 channel 17 analog input.
	UART0_nCTS	I	UART0 clear to Send input pin.
	USCI2_CTL1	I/O	USCI2 control 1 pin.
	TM2	I/O	Timer2 event counter input/toggle output pin.
	EBI_nCS0	O	EBI chip select 0 output pin.
14	PD.9	I/O	General purpose digital I/O pin.
	ADC0_CH18	A	ADC0 channel 18 analog input.
	UART0_RXD	I	UART0 data receiver input pin.
	USCI2_CTL0	I/O	USCI2 control 0 pin.
	ACMP1_P3	A	Analog comparator 1 positive input 3 pin.
	TM3	I/O	Timer3 event counter input/toggle output pin.
	EBI_ALE	O	EBI address latch enable output pin.
15	PD.1	I/O	General purpose digital I/O pin.
	ADC0_CH19	A	ADC0 channel 19 analog input.

Pin No.	Pin Name	Type	Description
	PWM0_SYNC_IN	I	PWM0 counter synchronous trigger input pin.
	UART0_TXD	O	UART0 data transmitter output pin.
	USCI2_CLK	I/O	USCI2 clock pin.
	ACMP1_P2	A	Analog comparator 1 positive input 2 pin.
	TM0	I/O	Timer0 event counter input/toggle output pin.
	EBI_nRD	O	EBI read enable output pin.
16	PD.2	I/O	General purpose digital I/O pin.
	ADC0_ST	I	ADC0 external trigger input pin.
	TM0_EXT	I/O	Timer0 external capture input/toggle output pin.
	USCI2_DAT0	I/O	USCI2 data 0 pin.
	ACMP1_P1	A	Analog comparator 1 positive input 1 pin.
	PWM0_BRAKE0	I	PWM0 Brake 0 input pin.
	EBI_nWR	O	EBI write enable output pin.
	INT0	I	External interrupt 0 input pin.
17	PD.3	I/O	General purpose digital I/O pin.
	TM2	I/O	Timer2 event counter input/toggle output pin.
	SPI0_I2SMCLK	I/O	SPI0 I2S master clock output pin
	TM1_EXT	I/O	Timer1 external capture input/toggle output pin.
	USCI2_DAT1	I/O	USCI2 data 1 pin.
	ACMP1_P0	A	Analog comparator 1 positive input 0 pin.
	PWM0_BRAKE1	I	PWM0 Brake 1 input pin.
	EBI_MCLK	O	EBI external clock output pin.
	INT1	I	External interrupt 1 input pin.
18	PD.4	I/O	General purpose digital I/O pin.
	SPI1_CLK	I/O	SPI1 serial clock pin.
	I2C0_SDA	I/O	I2C0 data input/output pin.
	UART2_nRTS	O	UART2 request to Send output pin.
	PWM0_BRAKE0	I	PWM0 Brake 0 input pin.
	TM0	I/O	Timer0 event counter input/toggle output pin.
19	PD.5	I/O	General purpose digital I/O pin.
	CLKO	O	Clock Out
	SPI1_MISO	I/O	SPI1 MISO (Master In, Slave Out) pin.

Pin No.	Pin Name	Type	Description
	I2C0_SCL	I/O	I2C0 clock pin.
	UART2_nCTS	I	UART2 clear to Send input pin.
	PWM0_BRAKE1	I	PWM0 Brake 1 input pin.
	TM1	I/O	Timer1 event counter input/toggle output pin.
20	PE.3	I/O	General purpose digital I/O pin.
	SPI1_MOSI	I/O	SPI1 MOSI (Master Out, Slave In) pin.
	UART2_RXD	I	UART2 data receiver input pin.
	PWM0_CH3	I/O	PWM0 channel 3 output/capture input.
21	PD.6	I/O	General purpose digital I/O pin.
	CLKO	O	Clock Out
	SPI1_SS	I/O	SPI1 slave select pin.
	UART0_RXD	I	UART0 data receiver input pin.
	UART2_TXD	O	UART2 data transmitter output pin.
	ACMP0_O	O	Analog comparator 0 output pin.
	PWM0_CH5	I/O	PWM0 channel 5 output/capture input.
	EBI_nWR	O	EBI write enable output pin.
22	V _{BAT}	P	Power supply by batteries for RTC.
23	PF.0	I/O	General purpose digital I/O pin.
	X32_OUT	O	External 32.768 kHz crystal output pin.
	USCI2_CTL1	I/O	USCI2 control 1 pin.
	INT5	I	External interrupt 5 input pin.
24	PF.1	I/O	General purpose digital I/O pin.
	X32_IN	I	External 32.768 kHz crystal input pin.
	USCI2_CTL0	I/O	USCI2 control 0 pin.
	PWM1_BRAKE0	I	PWM1 Brake 0 input pin.
25	PF.2	I/O	General purpose digital I/O pin.
	USCI2_CLK	I/O	USCI2 clock pin.
	PWM1_BRAKE1	I	PWM1 Brake 1 input pin.
26	PD.10	I/O	General purpose digital I/O pin.
	TM2	I/O	Timer2 event counter input/toggle output pin.
	USCI2_DAT0	I/O	USCI2 data 0 pin.
27	PD.11	I/O	General purpose digital I/O pin.

Pin No.	Pin Name	Type	Description
	TM3	I/O	Timer3 event counter input/toggle output pin.
	USCI2_DAT1	I/O	USCI2 data 1 pin.
28	PD.12	I/O	General purpose digital I/O pin.
	USCI1_CTL0	I/O	USCI1 control 0 pin.
	SPI1_SS	I/O	SPI1 slave select pin.
	UART0_TXD	O	UART0 data transmitter output pin.
	PWM1_CH0	I/O	PWM1 channel 0 output/capture input.
	EBI_ADR16	O	EBI address bus bit 16.
29	PD.13	I/O	General purpose digital I/O pin.
	USCI1_DAT1	I/O	USCI1 data 1 pin.
	SPI1_MOSI	I/O	SPI1 MOSI (Master Out, Slave In) pin.
	UART0_RXD	I	UART0 data receiver input pin.
	PWM1_CH1	I/O	PWM1 channel 1 output/capture input.
	EBI_ADR17	O	EBI address bus bit 17.
30	PD.14	I/O	General purpose digital I/O pin.
	USCI1_DAT0	I/O	USCI1 data 0 pin.
	SPI1_MISO	I/O	SPI1 MISO (Master In, Slave Out) pin.
	UART0_nCTS	I	UART0 clear to Send input pin.
	PWM1_CH2	I/O	PWM1 channel 2 output/capture input.
	EBI_ADR18	O	EBI address bus bit 18.
31	PD.15	I/O	General purpose digital I/O pin.
	USCI1_CLK	I/O	USCI1 clock pin.
	SPI1_CLK	I/O	SPI1 serial clock pin.
	UART0_nRTS	O	UART0 request to Send output pin.
	PWM1_CH3	I/O	PWM1 channel 3 output/capture input.
	EBI_ADR19	O	EBI address bus bit 19.
32	PD.7	I/O	General purpose digital I/O pin.
	USCI1_CTL1	I/O	USCI1 control 1 pin.
	SPI0_I2SMCLK	I/O	SPI0 I2S master clock output pin
	PWM0_SYNC_IN	I	PWM0 counter synchronous trigger input pin.
	TM1	I/O	Timer1 event counter input/toggle output pin.
	ACMP0_O	O	Analog comparator 0 output pin.

Pin No.	Pin Name	Type	Description
	PWM0_CH5	I/O	PWM0 channel 5 output/capture input.
	EBI_nRD	O	EBI read enable output pin.
33	PF.3	I/O	General purpose digital I/O pin.
	XT1_OUT	O	External 4~24 MHz (high speed) crystal output pin.
	I2C1_SCL	I/O	I2C1 clock pin.
34	PF.4	I/O	General purpose digital I/O pin.
	XT1_IN	I	External 4~24 MHz (high speed) crystal input pin.
	I2C1_SDA	I/O	I2C1 data input/output pin.
35	V _{SS}	P	Ground pin for digital circuit.
36	V _{DD}	P	Power supply for I/O ports and LDO source for internal PLL and digital circuit.
37	LDO_CAP	A	LDO output pin.
38	PC.9	I/O	General purpose digital I/O pin.
	SPI0_I2SMCLK	I/O	SPI0 I2S master clock output pin
	I2C1_SCL	I/O	I2C1 clock pin.
	USCI2_CTL1	I/O	USCI2 control 1 pin.
	PWM1_CH0	I/O	PWM1 channel 0 output/capture input.
39	PC.10	I/O	General purpose digital I/O pin.
	SPI0_MOSI	I/O	SPI0 MOSI (Master Out, Slave In) pin.
	I2C1_SDA	I/O	I2C1 data input/output pin.
	USCI2_DAT1	I/O	USCI2 data 1 pin.
	PWM1_CH1	I/O	PWM1 channel 1 output/capture input.
40	PC.11	I/O	General purpose digital I/O pin.
	SPI0_MISO	I/O	SPI0 MISO (Master In, Slave Out) pin.
	USCI2_CLK	I/O	USCI2 clock pin.
	PWM1_CH2	I/O	PWM1 channel 2 output/capture input.
41	PC.12	I/O	General purpose digital I/O pin.
	SPI0_CLK	I/O	SPI0 serial clock pin.
	USCI2_CTL0	I/O	USCI2 control 0 pin.
	PWM1_CH3	I/O	PWM1 channel 3 output/capture input.
42	PC.13	I/O	General purpose digital I/O pin.
	SPI0_SS	I/O	SPI0 slave select pin.

Pin No.	Pin Name	Type	Description
	USCI2_DAT0	I/O	USCI2 data 0 pin.
	PWM1_CH4	I/O	PWM1 channel 4 output/capture input.
43	PC.14	I/O	General purpose digital I/O pin.
	PWM1_CH5	I/O	PWM1 channel 5 output/capture input.
44	PC.0	I/O	General purpose digital I/O pin.
	SC0_DAT	I/O	Smart Card 0 data pin.
	SPI0_CLK	I/O	SPI0 serial clock pin.
	UART2_nCTS	I	UART2 clear to Send input pin.
	USCI0_DAT0	I/O	USCI0 data 0 pin.
	ACMP0_WLAT	I	Analog comparator 0 window latch input pin
	PWM0_CH0	I/O	PWM0 channel 0 output/capture input.
	EBI_AD8	I/O	EBI address/data bus bit 8.
	INT2	I	External interrupt 2 input pin.
45	PC.1	I/O	General purpose digital I/O pin.
	CLKO	O	Clock Out
	SC0_CLK	O	Smart Card 0 clock pin.
	UART2_nRTS	O	UART2 request to Send output pin.
	USCI0_DAT1	I/O	USCI0 data 1 pin.
	ACMP1_WLAT	I	Analog comparator 1 window latch input pin
	PWM0_CH1	I/O	PWM0 channel 1 output/capture input.
	EBI_AD9	I/O	EBI address/data bus bit 9.
46	PC.2	I/O	General purpose digital I/O pin.
	SC0_RST	O	Smart Card 0 reset pin.
	SPI0_SS	I/O	SPI0 slave select pin.
	UART2_TXD	O	UART2 data transmitter output pin.
	USCI0_CTL1	I/O	USCI0 control 1 pin.
	ACMP1_O	O	Analog comparator 1 output pin.
	PWM0_CH2	I/O	PWM0 channel 2 output/capture input.
	EBI_AD10	I/O	EBI address/data bus bit 10.
47	PC.3	I/O	General purpose digital I/O pin.
	SC0_PWR	O	Smart Card 0 power pin.
	SPI0_MOSI	I/O	SPI0 MOSI (Master Out, Slave In) pin.

Pin No.	Pin Name	Type	Description
	UART2_RXD	I	UART2 data receiver input pin.
	USCI0_CTL0	I/O	USCI0 control 0 pin.
	PWM0_CH3	I/O	PWM0 channel 3 output/capture input.
	EBI_AD11	I/O	EBI address/data bus bit 11.
48	PC.4	I/O	General purpose digital I/O pin.
	SC0_nCD	I	Smart Card 0 card detect pin.
	SPI0_MISO	I/O	SPI0 MISO (Master In, Slave Out) pin.
	I2C1_SCL	I/O	I2C1 clock pin.
	USCI0_CLK	I/O	USCI0 clock pin.
	PWM0_CH4	I/O	PWM0 channel 4 output/capture input.
	EBI_AD12	I/O	EBI address/data bus bit 12.
49	PE.0	I/O	General purpose digital I/O pin.
	SPI0_CLK	I/O	SPI0 serial clock pin.
	I2C1_SDA	I/O	I2C1 data input/output pin.
	TM2_EXT	I/O	Timer2 external capture input/toggle output pin.
	SC0_nCD	I	Smart Card 0 card detect pin.
	PWM0_CH0	I/O	PWM0 channel 0 output/capture input.
	EBI_nCS1	O	EBI chip select 1 output pin.
	INT4	I	External interrupt 4 input pin.
50	PC.5	I/O	General purpose digital I/O pin.
	SPI0_I2SMCLK	I/O	SPI0 I2S master clock output pin
	I2C1_SDA	I/O	I2C1 data input/output pin.
	USCI0_DAT0	I/O	USCI0 data 0 pin.
	PWM0_CH5	I/O	PWM0 channel 5 output/capture input.
	EBI_AD13	I/O	EBI address/data bus bit 13.
51	PC.6	I/O	General purpose digital I/O pin.
	USCI0_DAT1	I/O	USCI0 data 1 pin.
	ACMP1_O	O	Analog comparator 1 output pin.
	PWM1_CH0	I/O	PWM1 channel 0 output/capture input.
	EBI_AD14	I/O	EBI address/data bus bit 14.
52	PC.7	I/O	General purpose digital I/O pin.
	USCI0_CTL1	I/O	USCI0 control 1 pin.

Pin No.	Pin Name	Type	Description
	PWM1_CH1	I/O	PWM1 channel 1 output/capture input.
	EBI_AD15	I/O	EBI address/data bus bit 15.
53	PE.4	I/O	General purpose digital I/O pin.
	I2C0_SCL	I/O	I2C0 clock pin.
	I2C1_SCL	I/O	I2C1 clock pin.
	USCI0_CTL0	I/O	USCI0 control 0 pin.
	SC0_PWR	O	Smart Card 0 power pin.
	PWM1_BRAKE0	I	PWM1 Brake 0 input pin.
	EBI_nCS0	O	EBI chip select 0 output pin.
	INT0	I	External interrupt 0 input pin.
54	PE.5	I/O	General purpose digital I/O pin.
	I2C0_SDA	I/O	I2C0 data input/output pin.
	I2C1_SDA	I/O	I2C1 data input/output pin.
	USCI0_CLK	I/O	USCI0 clock pin.
	SC0_RST	O	Smart Card 0 reset pin.
	PWM1_BRAKE1	I	PWM1 Brake 1 input pin.
	EBI_ALE	O	EBI address latch enable output pin.
	INT1	I	External interrupt 1 input pin.
55	PE.6	I/O	General purpose digital I/O pin.
	ICE_CLK	I	Serial wired debugger clock pin.
	I2C0_SCL	I/O	I2C0 clock pin.
	UART0_RXD	I	UART0 data receiver input pin.
56	PE.7	I/O	General purpose digital I/O pin.
	ICE_DAT	O	Serial wired debugger data pin.
	I2C0_SDA	I/O	I2C0 data input/output pin.
	UART0_TXD	O	UART0 data transmitter output pin.
57	PA.8	I/O	General purpose digital I/O pin.
	UART1_TXD	O	UART1 data transmitter output pin.
	SC1_RST	O	Smart Card 1 reset pin.
	TM_BRAKE0	I	Timer Brake 0 input pin.
58	PA.9	I/O	General purpose digital I/O pin.
	UART1_RXD	I	UART1 data receiver input pin.

Pin No.	Pin Name	Type	Description
	SC1_PWR	O	Smart Card 1 power pin.
	TM_BRAKE1	I	Timer Brake 1 input pin.
59	PA.10	I/O	General purpose digital I/O pin.
	UART1_nCTS	I	UART1 clear to Send input pin.
	SC1_DAT	I/O	Smart Card 1 data pin.
60	PA.11	I/O	General purpose digital I/O pin.
	UART1_nRTS	O	UART1 request to Send output pin.
	SC1_CLK	O	Smart Card 1 clock pin.
61	PF.5	I/O	General purpose digital I/O pin.
	TM3_EXT	I/O	Timer3 external capture input/toggle output pin.
	SC1_nCD	I	Smart Card 1 card detect pin.
	TM_BRAKE0	I	Timer Brake 0 input pin.
62	PA.7	I/O	General purpose digital I/O pin.
	SPI1_CLK	I/O	SPI1 serial clock pin.
	TM0_EXT	I/O	Timer0 external capture input/toggle output pin.
	TM_BRAKE1	I	Timer Brake 1 input pin.
	EBI_AD7	I/O	EBI address/data bus bit 7.
63	PA.6	I/O	General purpose digital I/O pin.
	SPI1_MISO	I/O	SPI1 MISO (Master In, Slave Out) pin.
	TM1_EXT	I/O	Timer1 external capture input/toggle output pin.
	TM_BRAKE2	I	Timer Brake 2 input pin.
	EBI_AD6	I/O	EBI address/data bus bit 6.
64	PA.5	I/O	General purpose digital I/O pin.
	SPI1_MOSI	I/O	SPI1 MOSI (Master Out, Slave In) pin.
	TM2_EXT	I/O	Timer2 external capture input/toggle output pin.
	TM_BRAKE3	I	Timer Brake 3 input pin.
	EBI_AD5	I/O	EBI address/data bus bit 5.
65	PA.4	I/O	General purpose digital I/O pin.
	SPI1_SS	I/O	SPI1 slave select pin.
	TM3_EXT	I/O	Timer3 external capture input/toggle output pin.
	EBI_AD4	I/O	EBI address/data bus bit 4.
66	Vss	P	Ground pin for digital circuit.

Pin No.	Pin Name	Type	Description
67	V _{DD}	P	Power supply for I/O ports and LDO source for internal PLL and digital circuit.
68	PE.1	I/O	General purpose digital I/O pin.
	TM3_EXT	I/O	Timer3 external capture input/toggle output pin.
	SC0_nCD	I	Smart Card 0 card detect pin.
	PWM0_CH1	I/O	PWM0 channel 1 output/capture input.
69	PE.8	I/O	General purpose digital I/O pin.
	UART1_TXD	O	UART1 data transmitter output pin.
	TM0	I/O	Timer0 event counter input/toggle output pin.
	I2C1_SCL	I/O	I2C1 clock pin.
	SC0_PWR	O	Smart Card 0 power pin.
70	PE.9	I/O	General purpose digital I/O pin.
	UART1_RXD	I	UART1 data receiver input pin.
	TM1	I/O	Timer1 event counter input/toggle output pin.
	I2C1_SDA	I/O	I2C1 data input/output pin.
	SC0_RST	O	Smart Card 0 reset pin.
71	PE.10	I/O	General purpose digital I/O pin.
	SPI1_MISO	I/O	SPI1 MISO (Master In, Slave Out) pin.
	SPI0_MISO	I/O	SPI0 MISO (Master In, Slave Out) pin.
	UART1_nCTS	I	UART1 clear to Send input pin.
	SC0_DAT	I/O	Smart Card 0 data pin.
	SPI1_CLK	I/O	SPI1 serial clock pin.
	EBI_AD7	I/O	EBI address/data bus bit 7.
	TM0_EXT	I/O	Timer0 external capture input/toggle output pin.
72	PE.11	I/O	General purpose digital I/O pin.
	SPI1_MOSI	I/O	SPI1 MOSI (Master Out, Slave In) pin.
	SPI0_MOSI	I/O	SPI0 MOSI (Master Out, Slave In) pin.
	UART1_nRTS	O	UART1 request to Send output pin.
	SC0_CLK	O	Smart Card 0 clock pin.
	SPI1_MISO	I/O	SPI1 MISO (Master In, Slave Out) pin.
	EBI_AD6	I/O	EBI address/data bus bit 6.
	TM1_EXT	I/O	Timer1 external capture input/toggle output pin.

Pin No.	Pin Name	Type	Description
73	PE.12	I/O	General purpose digital I/O pin.
	SPI1_SS	I/O	SPI1 slave select pin.
	SPI0_SS	I/O	SPI0 slave select pin.
	UART1_TXD	O	UART1 data transmitter output pin.
	I2C0_SCL	I/O	I2C0 clock pin.
	SPI1_MOSI	I/O	SPI1 MOSI (Master Out, Slave In) pin.
	EBI_AD5	I/O	EBI address/data bus bit 5.
	TM2_EXT	I/O	Timer2 external capture input/toggle output pin.
74	PE.13	I/O	General purpose digital I/O pin.
	SPI1_CLK	I/O	SPI1 serial clock pin.
	SPI0_CLK	I/O	SPI0 serial clock pin.
	UART1_RXD	I	UART1 data receiver input pin.
	I2C0_SDA	I/O	I2C0 data input/output pin.
	SPI1_SS	I/O	SPI1 slave select pin.
	EBI_AD4	I/O	EBI address/data bus bit 4.
	TM3_EXT	I/O	Timer3 external capture input/toggle output pin.
75	V _{DDIO}	P	Power supply for PE.1, PE.8~PE.13.
76	PF.6	I/O	General purpose digital I/O pin.
77	PC.15	I/O	General purpose digital I/O pin.
	PWM1_CH0	I/O	PWM1 channel 0 output/capture input.
78	PB.12	I/O	General purpose digital I/O pin.
	PWM1_CH1	I/O	PWM1 channel 1 output/capture input.
79	PA.3	I/O	General purpose digital I/O pin.
	UART0_RXD	I	UART0 data receiver input pin.
	UART0_nRTS	O	UART0 request to Send output pin.
	I2C0_SCL	I/O	I2C0 clock pin.
	SC0_PWR	O	Smart Card 0 power pin.
	PWM1_CH2	I/O	PWM1 channel 2 output/capture input.
	EBI_AD3	I/O	EBI address/data bus bit 3.
	USCI1_CLK	I/O	USCI1 clock pin.
80	PA.2	I/O	General purpose digital I/O pin.
	UART0_TXD	O	UART0 data transmitter output pin.

Pin No.	Pin Name	Type	Description
	UART0_nCTS	I	UART0 clear to Send input pin.
	I2C0_SDA	I/O	I2C0 data input/output pin.
	SC0_RST	O	Smart Card 0 reset pin.
	PWM1_CH3	I/O	PWM1 channel 3 output/capture input.
	EBI_AD2	I/O	EBI address/data bus bit 2.
	USCI1_CTL0	I/O	USCI1 control 0 pin.
81	PA.1	I/O	General purpose digital I/O pin.
	UART1_nRTS	O	UART1 request to Send output pin.
	UART1_RXD	I	UART1 data receiver input pin.
	USCI1_CTL1	I/O	USCI1 control 1 pin.
	SC0_DAT	I/O	Smart Card 0 data pin.
	PWM1_CH4	I/O	PWM1 channel 4 output/capture input.
	EBI_AD1	I/O	EBI address/data bus bit 1.
82	PA.0	I/O	General purpose digital I/O pin.
	UART1_nCTS	I	UART1 clear to Send input pin.
	UART1_TXD	O	UART1 data transmitter output pin.
	USCI1_CTL0	I/O	USCI1 control 0 pin.
	SC0_CLK	O	Smart Card 0 clock pin.
	PWM1_CH5	I/O	PWM1 channel 5 output/capture input.
	EBI_AD0	I/O	EBI address/data bus bit 0.
	INT0	I	External interrupt 0 input pin.
83	PA.12	I/O	General purpose digital I/O pin.
	SPI1_I2SMCLK	I/O	SPI1 I2S master clock output pin
	UART2_RXD	I	UART2 data receiver input pin.
	UART1_RXD	I	UART1 data receiver input pin.
	TM_BRAKE2	I	Timer Brake 2 input pin.
84	PA.13	I/O	General purpose digital I/O pin.
	UART2_TXD	O	UART2 data transmitter output pin.
	UART1_TXD	O	UART1 data transmitter output pin.
	TM_BRAKE3	I	Timer Brake 3 input pin.
85	PA.14	I/O	General purpose digital I/O pin.
	UART2_nCTS	I	UART2 clear to Send input pin.

Pin No.	Pin Name	Type	Description
	USCI1_CTL1	I/O	USCI1 control 1 pin.
	TM2	I/O	Timer2 event counter input/toggle output pin.
86	PA.15	I/O	General purpose digital I/O pin.
	UART2_nRTS	O	UART2 request to Send output pin.
	USCI1_CLK	I/O	USCI1 clock pin.
	TM3	I/O	Timer3 event counter input/toggle output pin.
87	V _{SS}	P	Ground pin for digital circuit.
88	V _{DD}	P	Power supply for I/O ports and LDO source for internal PLL and digital circuit.
89	AV _{DD}	P	Power supply for internal analog circuit.
90	V _{REF}	A	ADC reference voltage input. Note: This pin needs to be connected with a 1uF capacitor.
91	PB.0	I/O	General purpose digital I/O pin.
	ADC0_CH0	A	ADC0 channel 0 analog input.
	VDET_P0	A	Voltage detector positive input 0 pin.
	UART2_RXD	I	UART2 data receiver input pin.
	TM2	I/O	Timer2 event counter input/toggle output pin.
	USCI1_DAT0	I/O	USCI1 data 0 pin.
	EBI_nWRL	O	EBI low byte write enable output pin.
	INT1	I	External interrupt 1 input pin.
92	PB.1	I/O	General purpose digital I/O pin.
	ADC0_CH1	A	ADC0 channel 1 analog input.
	VDET_P1	A	Voltage detector positive input 1 pin.
	UART2_TXD	O	UART2 data transmitter output pin.
	TM3	I/O	Timer3 event counter input/toggle output pin.
	SC0_RST	O	Smart Card 0 reset pin.
	PWM0_SYNC_OUT	O	PWM0 counter synchronous trigger output pin.
	EBI_nWRH	O	EBI high byte write enable output pin
	USCI1_DAT1	I/O	USCI1 data 1 pin.
	93	PB.2	I/O
ADC0_CH2		A	ADC0 channel 2 analog input.
SPI0_CLK		I/O	SPI0 serial clock pin.

Pin No.	Pin Name	Type	Description
	SPI1_CLK	I/O	SPI1 serial clock pin.
	UART1_RXD	I	UART1 data receiver input pin.
	SC0_nCD	I	Smart Card 0 card detect pin.
	TM_BRAKE0	I	Timer Brake 0 input pin.
	EBI_nCS0	O	EBI chip select 0 output pin.
	USCI0_DAT0	I/O	USCI0 data 0 pin.
94	PB.3	I/O	General purpose digital I/O pin.
	ADC0_CH3	A	ADC0 channel 3 analog input.
	SPI0_MISO	I/O	SPI0 MISO (Master In, Slave Out) pin.
	SPI1_MISO	I/O	SPI1 MISO (Master In, Slave Out) pin.
	UART1_TXD	O	UART1 data transmitter output pin.
	TM_BRAKE1	I	Timer Brake 1 input pin.
	EBI_ALE	O	EBI address latch enable output pin.
	USCI0_DAT1	I/O	USCI0 data 1 pin.
95	PB.4	I/O	General purpose digital I/O pin.
	ADC0_CH4	A	ADC0 channel 4 analog input.
	SPI0_SS	I/O	SPI0 slave select pin.
	SPI1_SS	I/O	SPI1 slave select pin.
	UART1_nCTS	I	UART1 clear to Send input pin.
	ACMP0_N	A	Analog comparator 0 negative input pin.
	SC1_nCD	I	Smart Card 1 card detect pin.
	EBI_AD7	I/O	EBI address/data bus bit 7.
	USCI0_CTL1	I/O	USCI0 control 1 pin.
96	PB.8	I/O	General purpose digital I/O pin.
	ADC0_CH5	A	ADC0 channel 5 analog input.
	UART1_nRTS	O	UART1 request to Send output pin.
	TM_BRAKE2	I	Timer Brake 2 input pin.
	PWM0_CH2	I/O	PWM0 channel 2 output/capture input.
	USCI0_CTL0	I/O	USCI0 control 0 pin.
97	PB.9	I/O	General purpose digital I/O pin.
	ADC0_CH6	A	ADC0 channel 6 analog input.
	USCI0_CLK	I/O	USCI0 clock pin.

Pin No.	Pin Name	Type	Description
98	PB.10	I/O	General purpose digital I/O pin.
	ADC0_CH7	A	ADC0 channel 7 analog input.
99	PB.11	I/O	General purpose digital I/O pin.
	ADC0_CH8	A	ADC0 channel 8 analog input.
100	PE.2	I/O	General purpose digital I/O pin.
	ADC0_CH9	A	ADC0 channel 9 analog input.
	UART1_nRTS	O	UART1 request to Send output pin.
	TM_BRAKE3	I	Timer Brake 3 input pin.
	PWM0_CH2	I/O	PWM0 channel 2 output/capture input.
	USCI0_CTL0	I/O	USCI0 control 0 pin.

Table 2-1 Pin Assignment for M0564

2.3 NuTiny-SDK-M0564 PCB Placement

Users can refer to Figure 2-2 for the NuTiny-SDK-M0564 PCB placement.

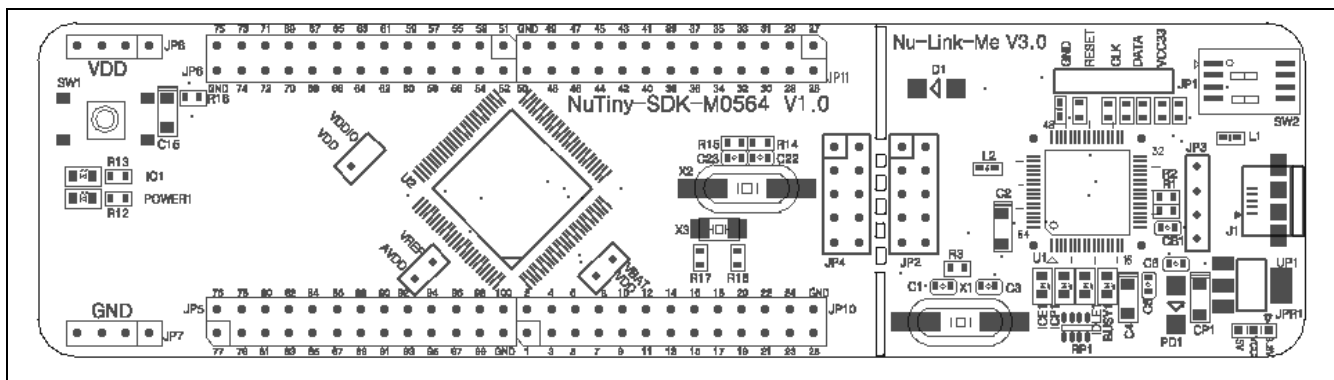

Figure 2-2 NuTiny-SDK-M0564 PCB Placement

3 HOW TO START NUTINY-SDK-M0564 ON THE KEIL MVISION® IDE

3.1 Keil uVision® IDE Software Download and Install

Please visit the Keil company website (<http://www.keil.com>) to download the Keil μ Vision® IDE and install the RVMDK.

3.2 Nuvoton Nu-Link Driver Download and Install

Please visit the Nuvoton company NuMicro® website (<http://www.nuvoton.com/NuMicro>) to download “NuMicro® Keil μ Vision® IDE driver” file. When the Nu-Link driver has been well downloaded, please unzip the file and execute the “Nu-Link_Keil_Driver.exe” to install the driver.

3.3 Hardware Setup

The hardware setup is shown as Figure 3-1.

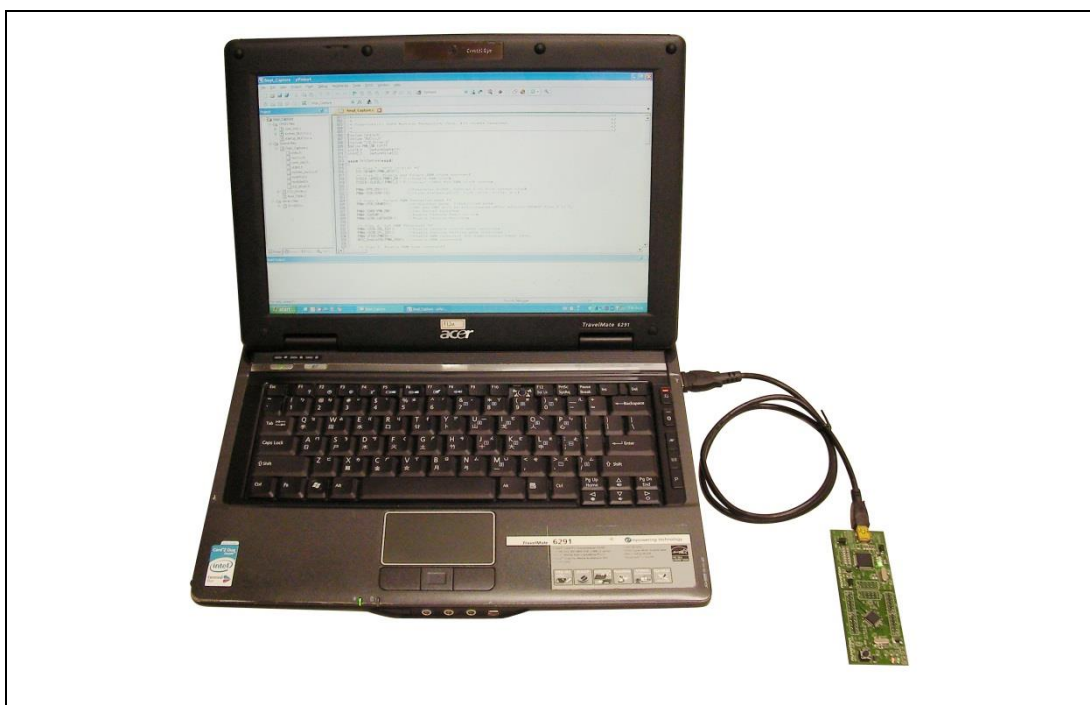

Figure 3-1 NuTiny-SDK-M0564 Hardware Setup

3.4 Example Program

This example demonstrates the ease of downloading and debugging an application on a NuTiny-SDK-M0564 board. It can be found on Figure 3-2 list directory and downloaded from Nuvoton NuMicro® website.

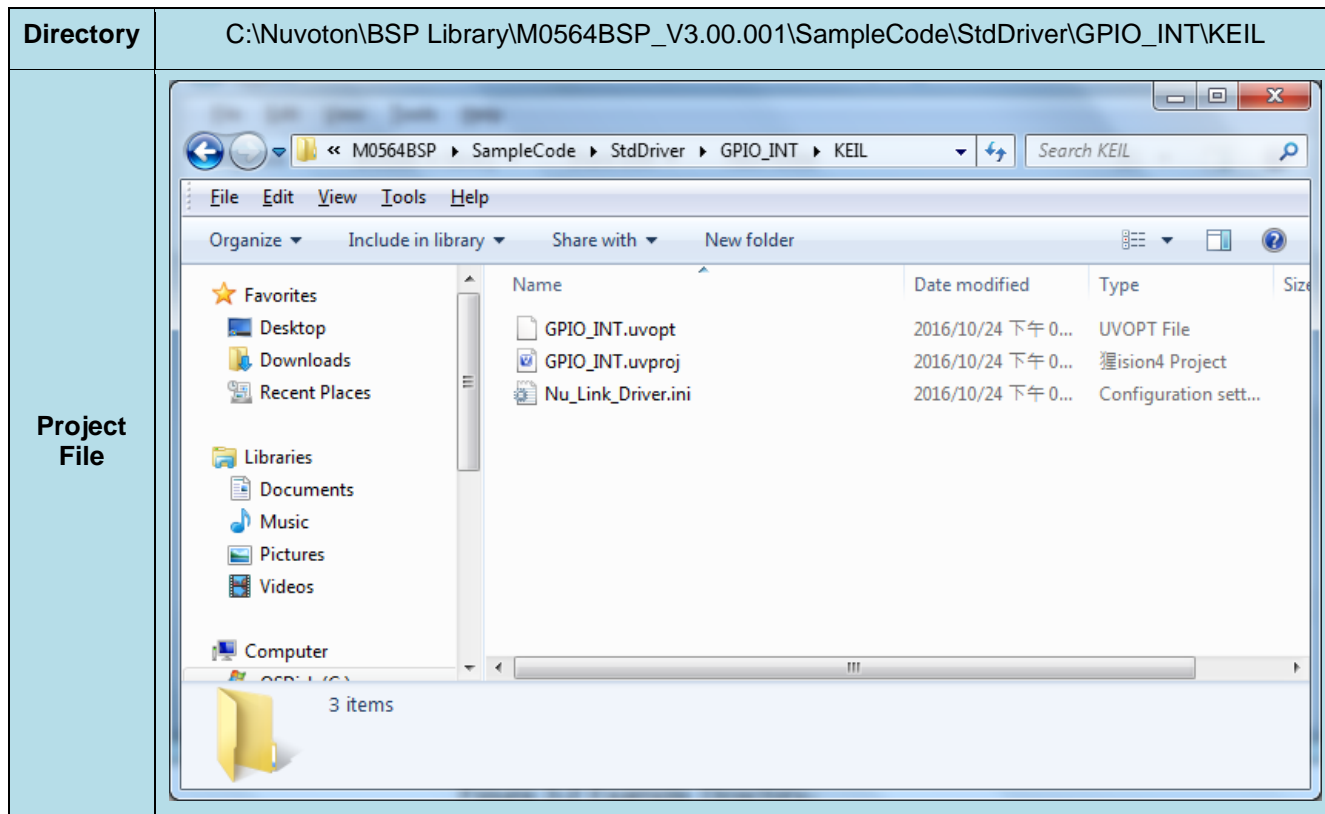









Figure 3-2 Example Directory

To use this example:

This sample code runs some functions about system manager controller and clock controller, and will show messages by Uart. Users can see the messages by following the steps of Chapter 5.

-  **Start µVision®**
- **Project-Open**
Open the SYS.uvproj project file
-  **Project - Build**
Compile and link the SYS application
-  **Flash – Download**
Program the application code into on-chip Flash ROM
-  **Start debug mode**
Using the debugger commands, you may:
 - ◆  Review variables in the watch window
 - ◆  Single step through code
 - ◆  RST Reset the device
 - ◆  Run the application

4 HOW TO START NUTINY-SDK-M0564 ON THE IAR EMBEDDED WORKBENCH

4.1 IAR Embedded Workbench Software Download and Install

Please connect to IAR company website (<http://www.iar.com>) to download the IAR Embedded Workbench and install the EWARM.

4.2 Nuvoton Nu-Link Driver Download and Install

Please visit the Nuvoton company NuMicro[®] website (<http://www.nuvoton.com/NuMicro>) to download the “NuMicro[®] IAR EWARM Driver” file. When the Nu-Link driver has been well downloaded, please unzip the file and execute the “Nu-Link_Keil_Driver.exe” to install the driver.

4.3 Hardware Setup

The hardware setup is shown as Figure 4-1.

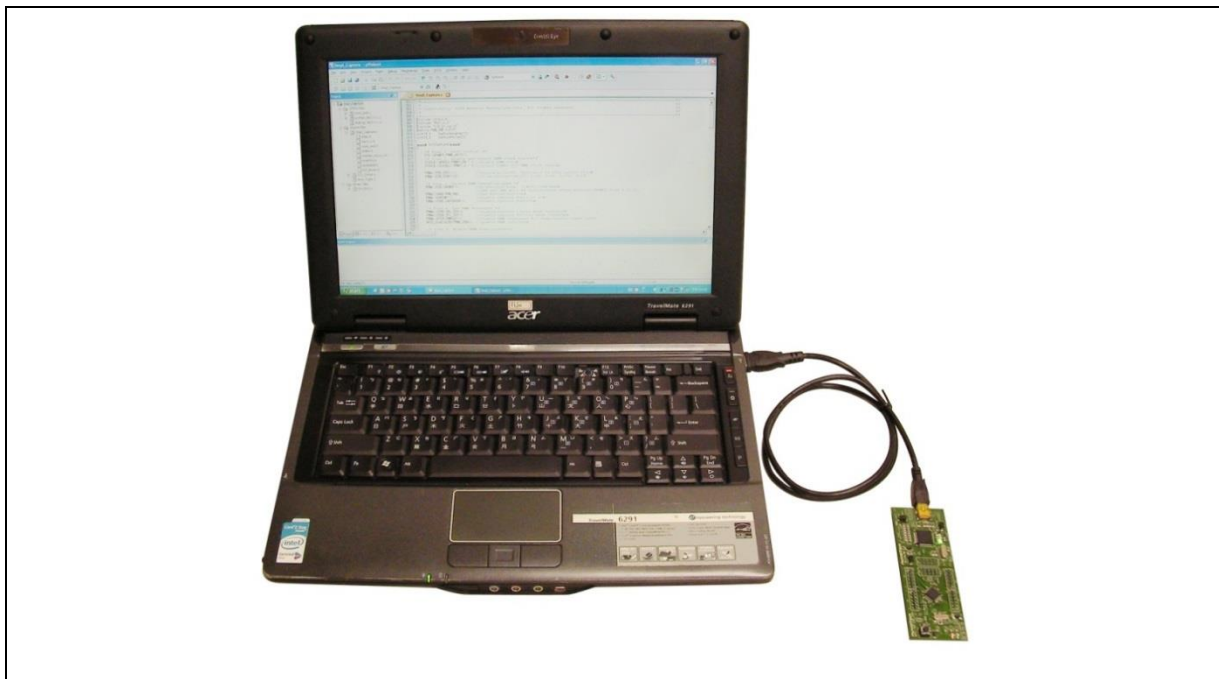

Figure 4-1 NuTiny-SDK-M0564 Hardware Setup

4.4 Example Program

This example demonstrates the ease of downloading and debugging an application on a NuTiny-SDK-M0564 board. It can be found on Figure 4-2 list directory and downloaded from Nuvoton NuMicro® website.

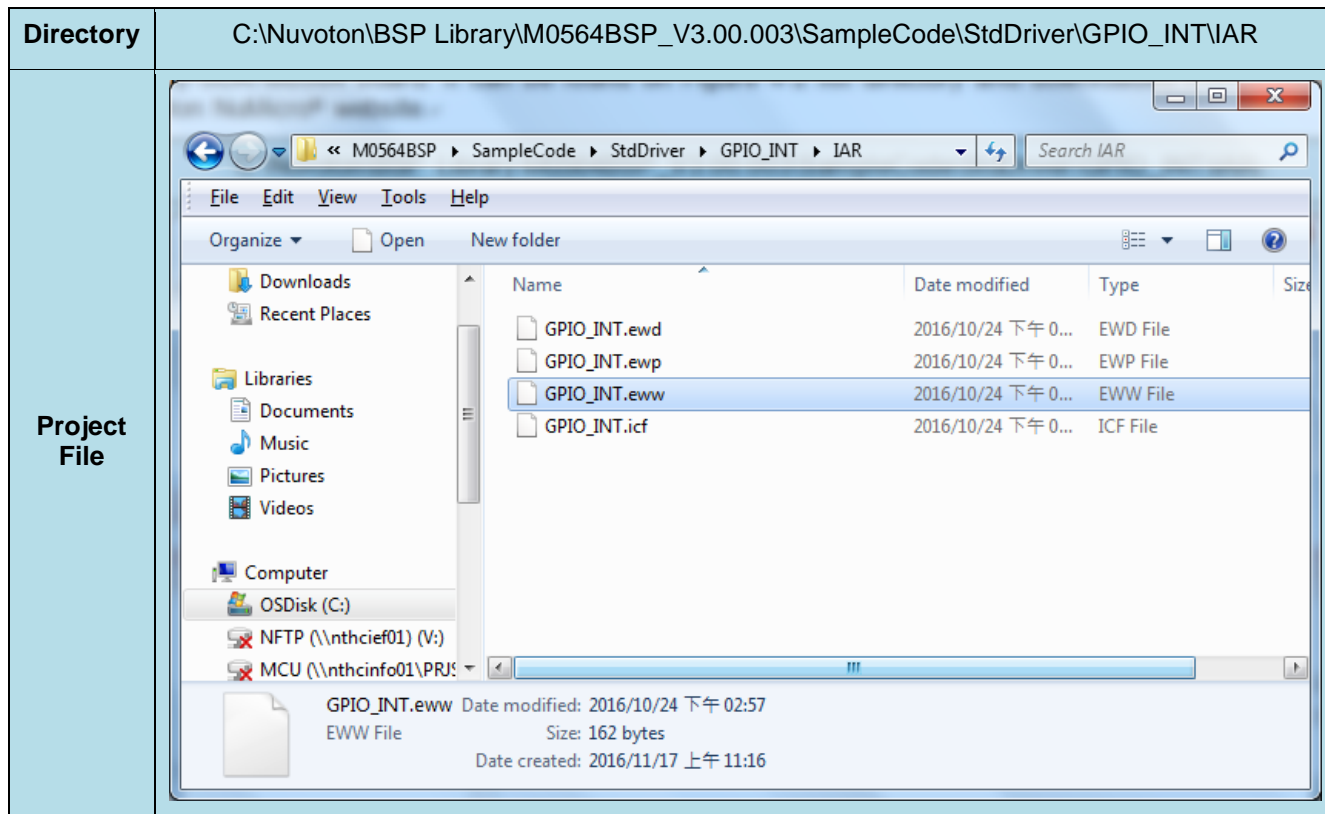







Figure 4-2 Example Directory

To use this example:

This sample code runs some functions about system manager controller and clock controller, and will show messages by Uart. Users can see the messages by following the steps of Chapter 5.

-  Start IAR Embedded Workbench
-  Project – Download and Debug
Program the application code into on-chip Flash ROM
- File-Open-Workspace
Open the SYS.eww workspace file
-  Single step through code
-  Reset the device
-  Project - Make
Compile and link the SYS application
-  Run the application

5 STARTING TO USE NU-LINK-ME 3.0 VCOM FUNCTION

5.1 Downloading and Installing VCOM Driver

Please connect to Nuvoton NuMicro® website (<http://www.nuvoton.com/NuMicro>) to download the “NuMicro® ICP Programming Tool” file. After the ICP Programming Tool driver is downloaded, please unzip the file and execute the “ICP Programming Tool.exe”. Simply follow the installation and optional steps to install ICP Programming Tool and Nu-Link USB Driver, which included VCOM driver.

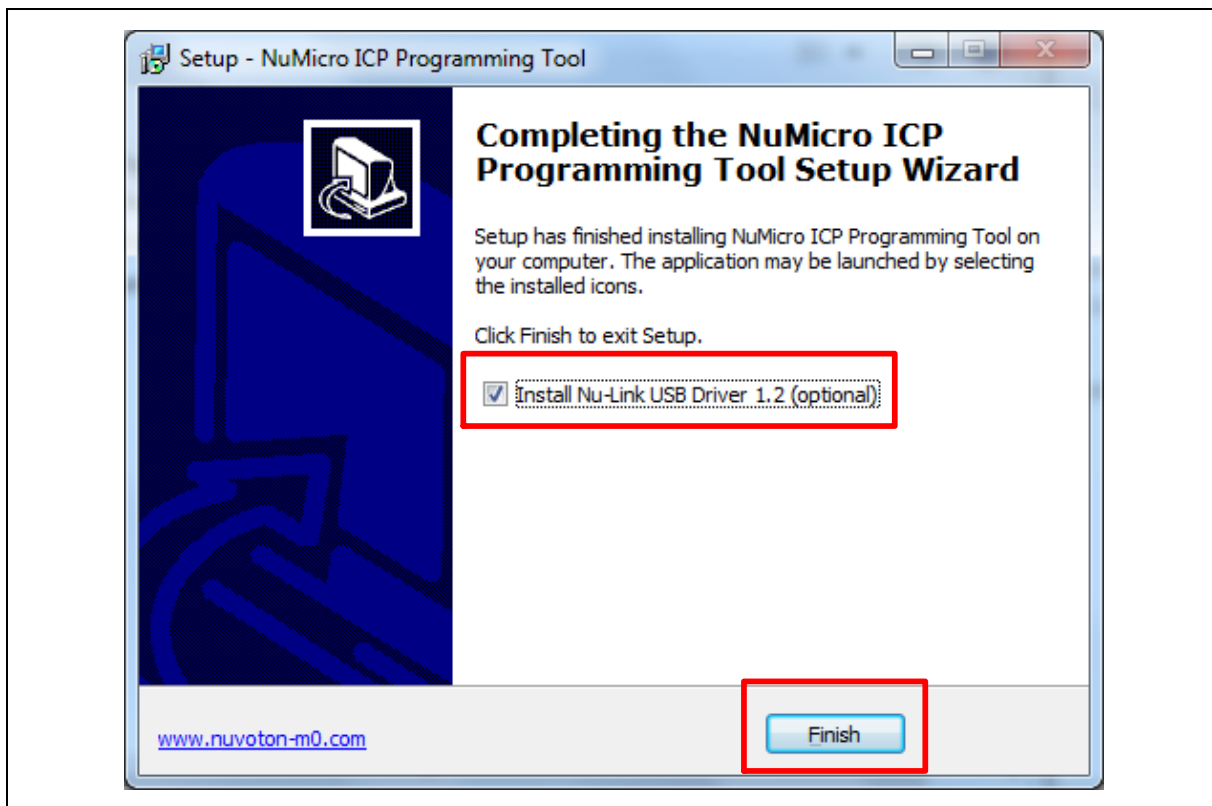

Figure 5-1 Optional Step after ICP Programming Tool Installation

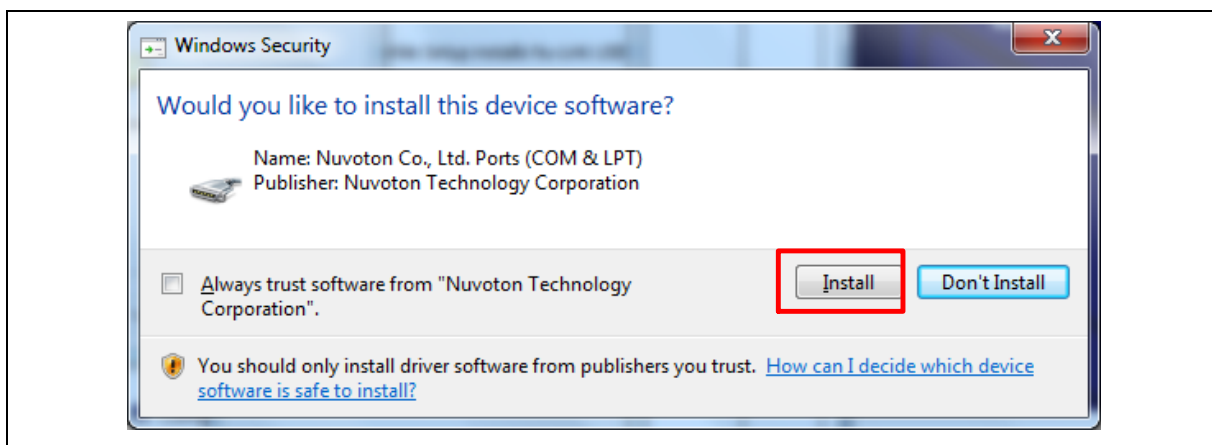

Figure 5-2 Install Nuvoton COM&LPT Driver

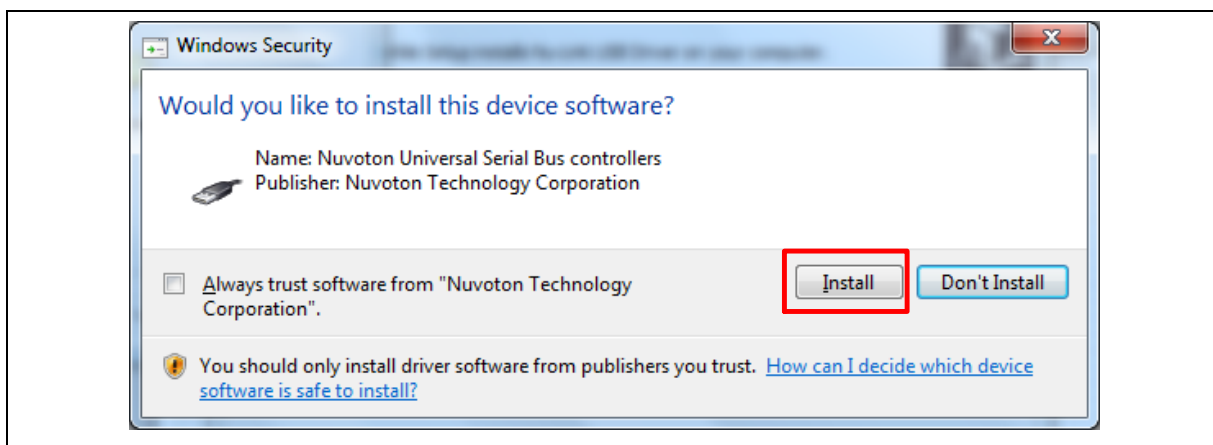

Figure 5-3 Install Nuvoton Universal Serial Bus Controllers

5.2 VCOM Mode Setting on NuTiny-SDK-M0564

Before the NuTiny-SDK-M0564 is connected to the PC, please enable SW2 VCOM function by switching on SW2. The NuTiny-EVB-M0564 transmits through UART0 to VCOM to send out data. Switch SW2 off when using UART0 function without VCOM function.

After connected USB port in Nu-Link-Me to the PC, user can find a "Nuvoton Virtual Com Port" from Device Manager as Figure 5-4.

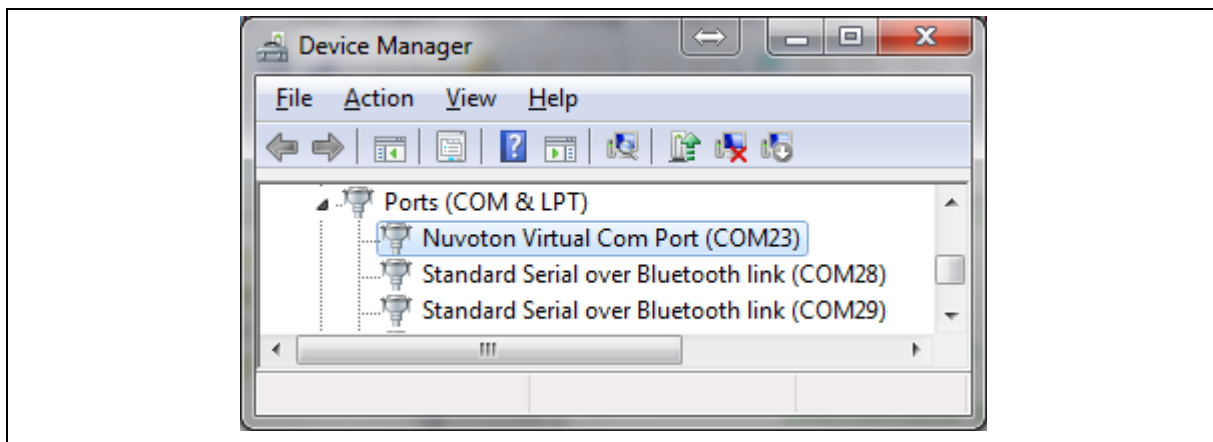

Figure 5-4 Nuvoton Virtual Com Port

5.3 Setup on the Development Tool

The example is demonstrated on the Keil μ Vision[®] IDE.

5.3.1 Check the Using UART on the Keil μ Vision[®] IDE

Please open the project and find system_M0564.h (which can be found in \\M0564BSP_CMSIS_V3.00.001\Library\Device\Nuvoton\M0564\Include) to check the using UART in DEBUG_PORT. The setting has to be the same as the using UART in the NuTiny-EVB-M0564.

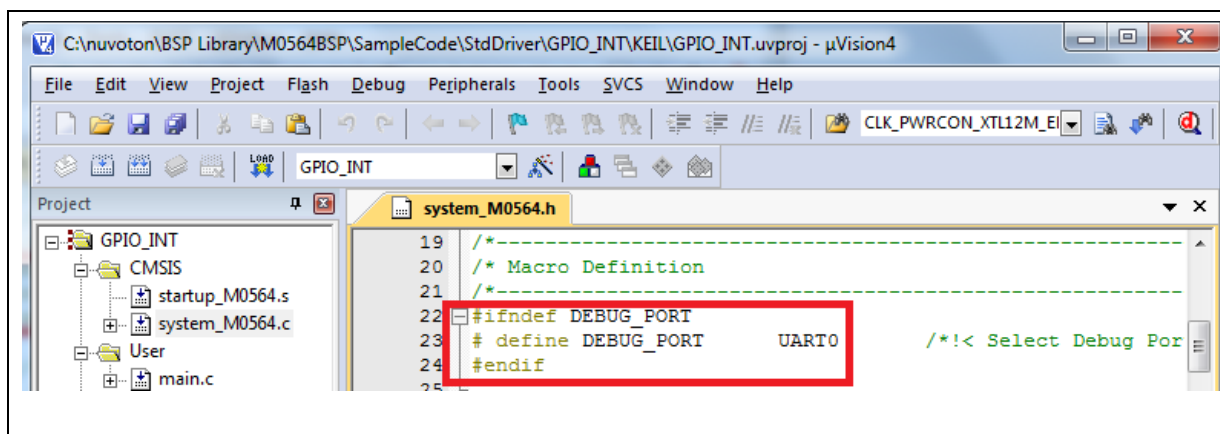
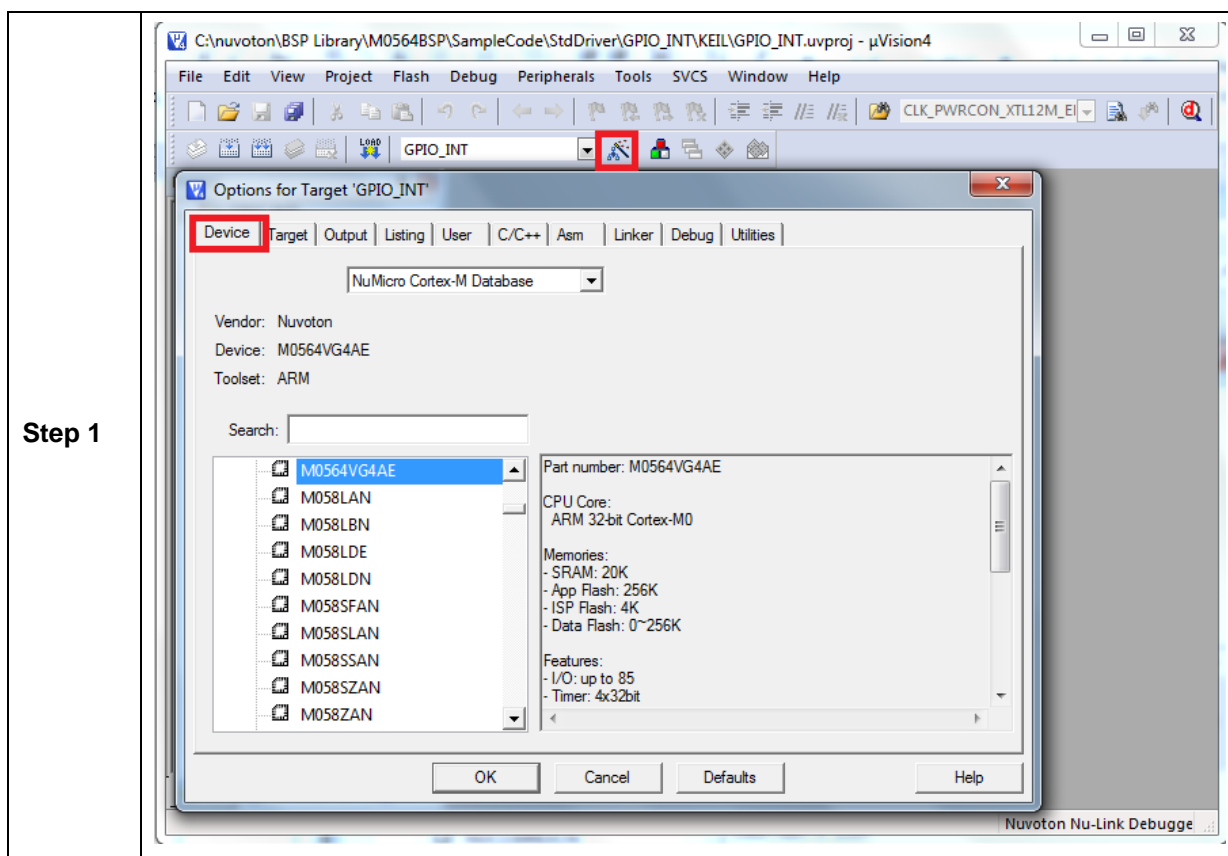

Figure 5-5 The Using UART on Keil μVision® IDE

5.3.2 Check the Target Device and Debug Setting

The target device has to be the same as the setting in Debug. Please click “Target Option” to open the Option windows, and find the setting in “Device”, “Debug”, and “Utilities” page. Please follow the steps below to check the setting.



Step 2

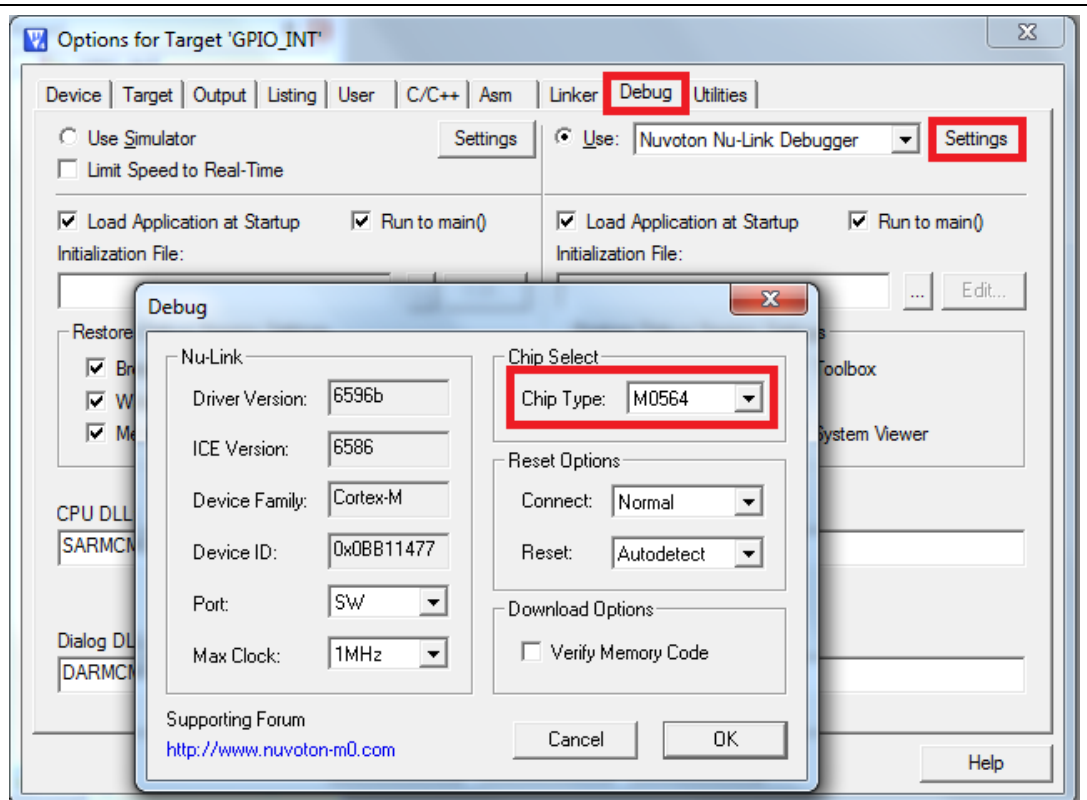

Step 3

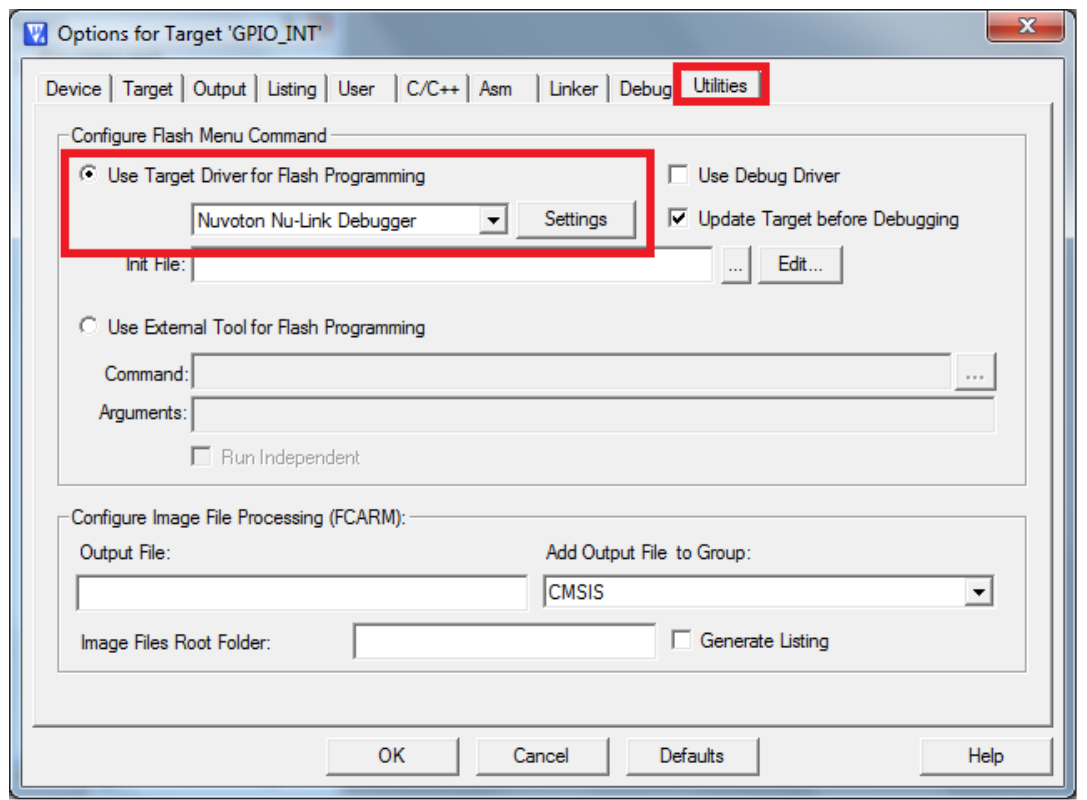

5.3.3 Build and Download Code to NuTiny-SDK-M0564

Please build the project and download code to NuTiny-SDK-M0564.

5.3.4 Open the Serial Port Terminal

User can use serial port terminal, PuTTY for example, to print out debug message.

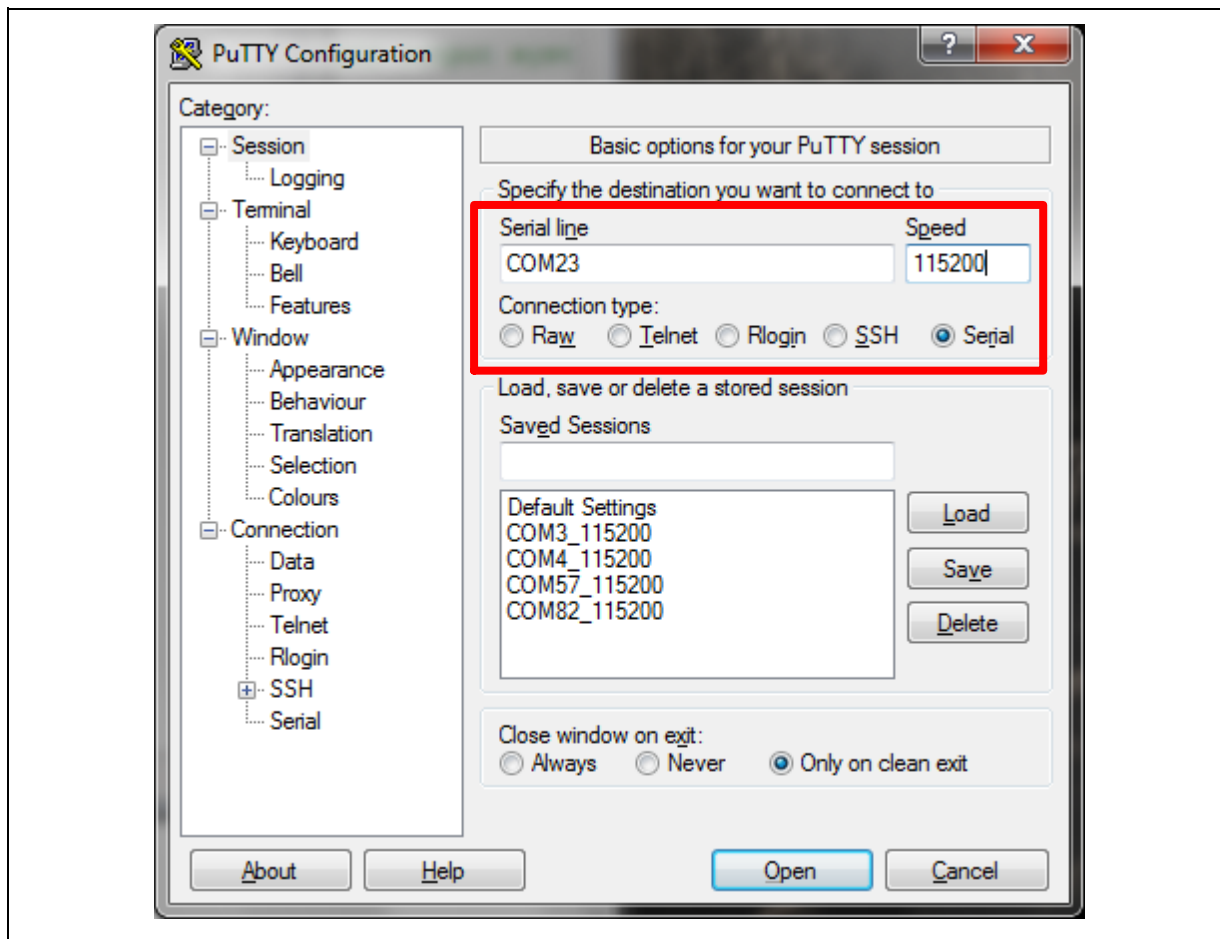

Figure 5-6 Set Baud Rate

5.3.5 Reset Chip

After pushing the reset button, the chip will reprogram application and print out debug message.

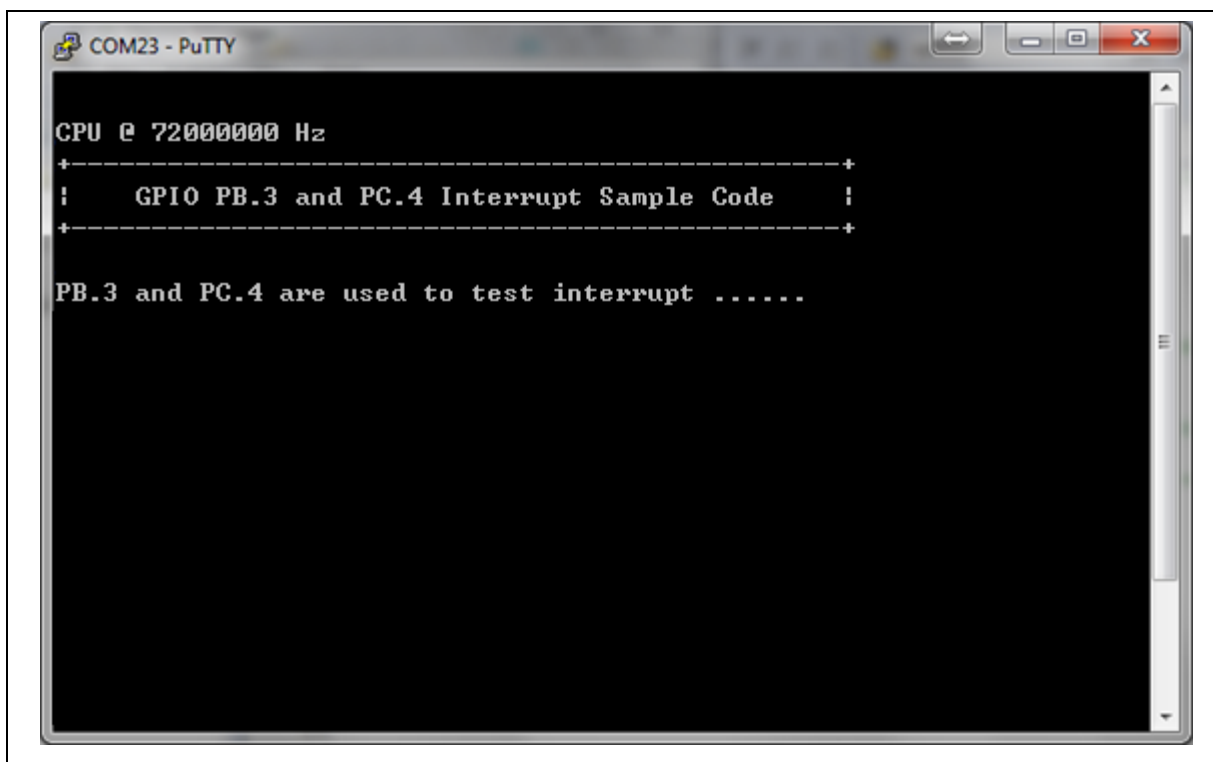
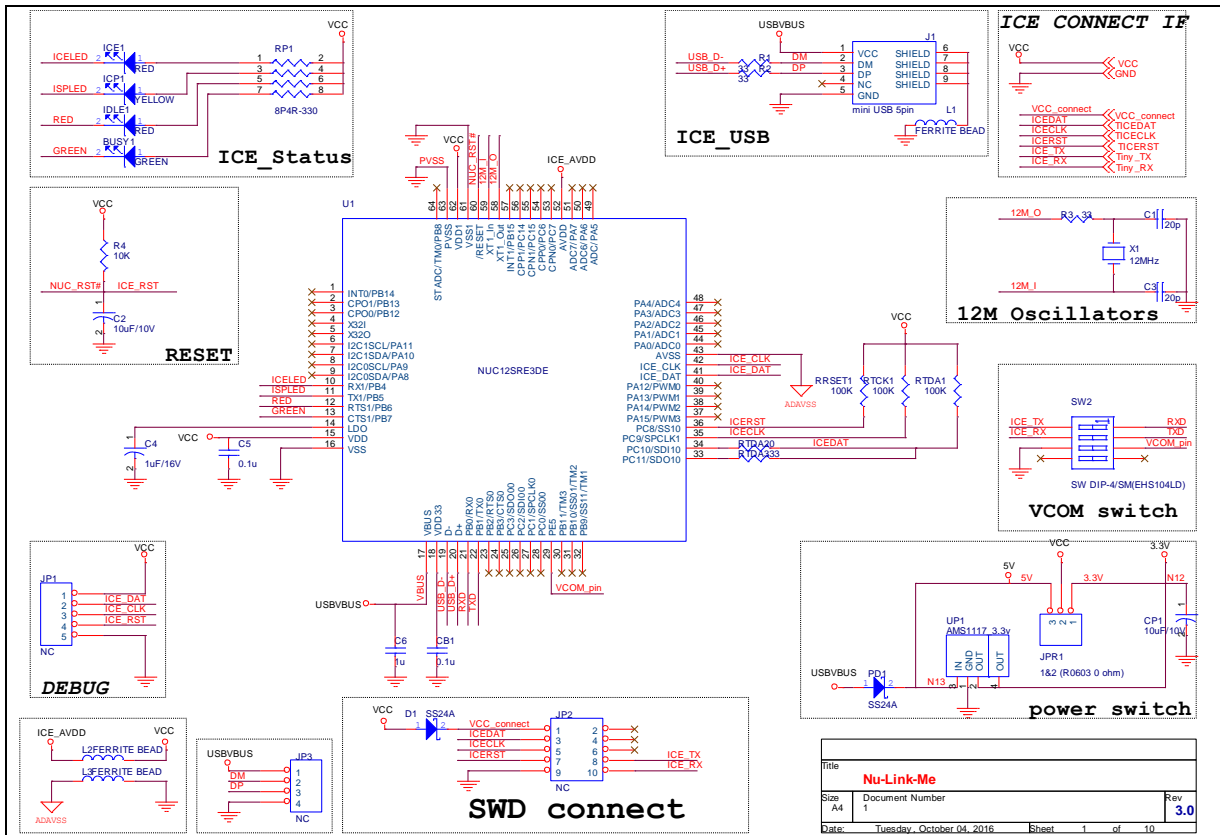

Figure 5-7 Serial Port Terminal Windows

Notice: Please switch SW2 on before the NuTiny-SDK-M0564 connects to the PC. When the NuTiny-SDK-M0564 connects to the PC with SW2 switch on, PC will detect VCOM as a USB device and the detection will only be processed once. VCOM will not function if switch on SW2 after the connection.

6.2 Nu-Link-Me V3.0 Schematic



7 REVISION HISTORY

Date	Revision	Description
2017.05.23	1.00	1. Initially issued.

Important Notice

Nuvoton Products are neither intended nor warranted for usage in systems or equipment, any malfunction or failure of which may cause loss of human life, bodily injury or severe property damage. Such applications are deemed, "Insecure Usage".

Insecure usage includes, but is not limited to: equipment for surgical implementation, atomic energy control instruments, airplane or spaceship instruments, the control or operation of dynamic, brake or safety systems designed for vehicular use, traffic signal instruments, all types of safety devices, and other applications intended to support or sustain life.

All Insecure Usage shall be made at customer's risk, and in the event that third parties lay claims to Nuvoton as a result of customer's Insecure Usage, customer shall indemnify the damages and liabilities thus incurred by Nuvoton.

*Please note that all data and specifications are subject to change without notice.
All the trademarks of products and companies mentioned in this datasheet belong to their respective owners.*