

# New Scale Technologies

DK-M3-RS-U-2M-20-L

Developer's Kit

## Two-Axis / Two-Mirror Beam Steering System

Miniature piezo smart stages  
with built-in controllers enable simple,  
precise point-to-point beam steering

SMALL, PRECISE, SMART ... IN MOTION

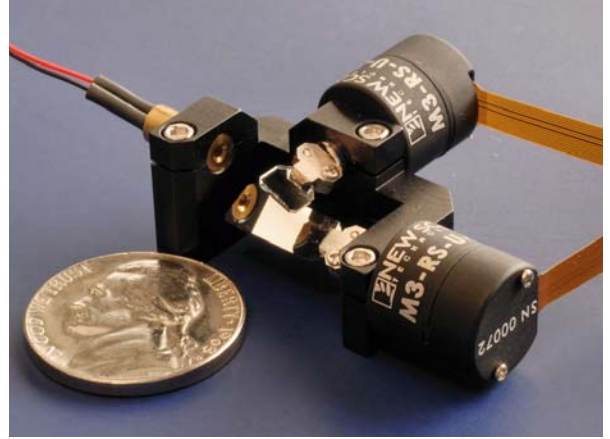

- Piezo stages with familiar digital galvo form factor
- Mounted mirrors, laser and two-axis base
- Each stage < 12 mm diameter
- Closed-loop controller embedded in stage
  - *No separate electronics needed*
  - 3.3 VDC input
  - Direct digital input of motion commands (I<sup>2</sup>C, SPI, UART) or analog servo
- Steers beam diameters up to 2 mm
- Angular resolution 0.025 deg (440 μrad) closed loop with built-in absolute position sensor
- Angular resolution 0.0057 deg (100 μrad) open loop with external position sensor provided by user
- Holds position with zero power and no jitter

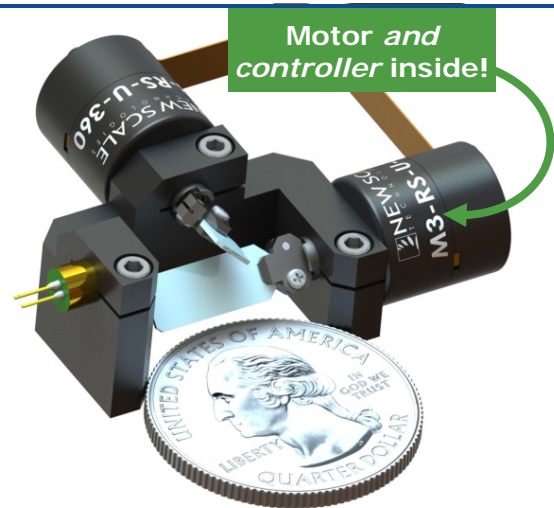

### Two-axis beam steering on your fingertip

The DK-M3-RS-U-2M-20-L is a complete piezoelectric beam steering system with a familiar galvo-scanner form factor, but a drastically smaller size: **only 12 mm diameter including the embedded closed-loop controller.**

The mounted aluminum-coated mirror moves at up to 1100 degrees per second with accuracy of 0.25 degrees for precise, point-to-point beam steering. The mirror range is +/- 20 degrees.

### Embedded controller means tiny size plus fast, easy integration

Patented piezoelectric motors along with position sensors, bearings, drive electronics and embedded firmware are all integrated into the miniature rotary stage.

We've eliminated the extra bulk of a separate external controller.

Along with smallest system size, this makes for fast, easy integration into your system. The beam steering system accepts direct input of high-level digital or analog motion commands from your system processor, or use the USB adapter to power and control the system from a PC. Input is only 3.3 VDC.

### APPLICATIONS

This system is ideal for precise, point-to-point beam steering in a limited space, where dynamic scanning is limited to less than 100 Hz. The 3.3 VDC input makes it suited for handheld/portable instruments.

#### Medical

- Dermatology lasers, fluorescence microscopes and imaging instruments
- In-vivo and in-vitro micro laser surgery

#### Industrial

- 3D printers
- LIDAR, 3D measurement, spectroscopy
- Remote sensing (e.g. pollution sources)
- Image and hand tremor stabilization
- Laser marking, engraving, machining

#### Telecommunications

- Free-space optical communication
- Variable optical attenuation
- Fiber-to-fiber optical switching

#### Aerospace and Defense

- Target designation, jitter compensation
- Automated obstacle detection, tracking and avoidance for robots, UAVs, etc.

## The Developer's Kit

The DK-M3-RS-U-2M-20-L Beam Steering System Developer's Kit includes two smart stages, mounted mirrors, a 650nm collimated laser, base, demo board, cables, USB adapter and software for system evaluation and development.

### Smart Stages with mounted mirrors, laser and base

The standard aluminum-coated mirrors are pre-mounted on the M3-RS-U smart stages. The stages' built-in controllers accept direct digital and analog servo control via the FPC connector.



**Rotary smart stage #1**  
with embedded controller  
(M3-RS-U-360)

**Short Mirror**  
(M3-RS-U-Mirror-01-03)

**Demo Laser**  
650nm collimated

**Base**

**Flex Cables** with straight exit  
from stage, 150 mm length  
(M3-RS-U-FPC-0-150)

**Rotary smart stage #2**  
with embedded controller  
(M3-RS-U-360)

**Long Mirror**  
(M3-RS-U-Mirror-01-11)

### Included accessories

The Developer's Kit accessories include a demo board, cables, tools and software to aid in evaluation and system development. New Scale Pathway™ software for Windows provides an easy-to-use graphical interface to control the systems from a PC screen, or develop your own code using the intuitive scripting tool.

#### Demo Board

Interface to PC  
Connection to laser power supply  
Direct access to:

- SPI, I<sup>2</sup>C and UART digital control interfaces
- Analog Servo (Input) up to ±10V
- PWM Position (Output)
- Scope probe
- ON Target (Output)
- DC Power

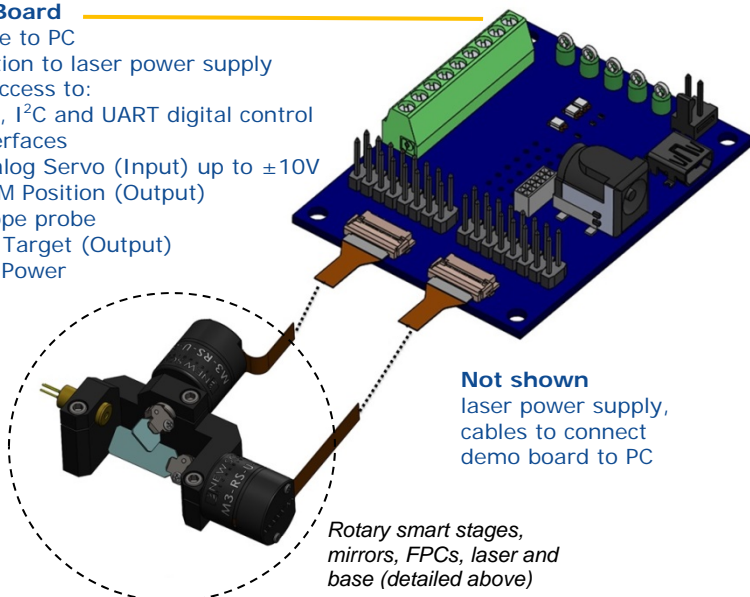

**Not shown**  
laser power supply,  
cables to connect  
demo board to PC

*Rotary smart stages,  
mirrors, FPCs, laser and  
base (detailed above)*

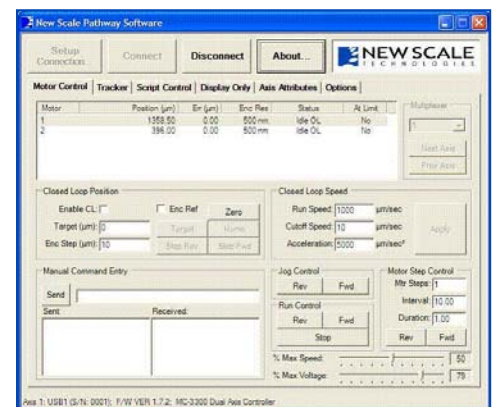

#### New Scale Pathway Software for Windows

For system evaluation and development

## Specifications – DK-M3-RS-U-2M-20-L Developer's Kit

<b>M3-RS-U smart stage with standard 3-mm length mounted mirror (short mirror)</b>	
Beam Diameter (maximum)	2 mm
Range of Motion	+/- 20 deg
Speed	>1100 deg/sec
Acceleration	>1,000,000 deg/sec <sup>2</sup> *
Stall Torque (minimum)	0.04 N-mm
Holding Torque (minimum)	0.08 N-mm (zero power)
<b>Recommended Maximum Payload</b> mounted to rotating shaft (Payload must be balanced)	
Mass	3 g
Inertia	350 g-mm <sup>2</sup>
<b>CLOSED-LOOP performance</b> (with built-in position sensor)	
Recommended Step Frequency	Up to 100 Hz
Resolution (encoder resolution)	0.025 deg (440 µrad) absolute
Repeatability	+/-0.05 deg (880 µrad)
Accuracy	0.25 deg (4400 µrad)
<b>Maximum Closed-Loop Step &amp; Settle Times</b> (0.99 g-mm <sup>2</sup> inertial load*)	
0.5 deg	9 ms
5 deg	14 ms
20 deg	21 ms
<b>OPEN-LOOP performance</b> (external position sensor provided by user)	
Resolution	<0.0057 deg (<100 µrad)
Accuracy	Typically better than 10% of distance travelled after calibration
<b>Maximum Open-Loop Step Times</b> (0.99 g-mm <sup>2</sup> inertial load*)	
0.05 deg	0.5 ms
0.5 deg	1.6 ms
5 deg	6 ms
20 deg	10 ms
Input Voltage	3.3 V DC
<b>Power Consumption (typical)</b>	
Input directly to stage	500 mW active, moving 190 mW active, ready 50 mW standby
Input via USB interface (demo board)	1200 mW active, both axes moving 580 mW active, ready 200 mW standby
Stage Mass	3 g
Operational Lifetime	100 million random positions
Temperature/Relative Humidity	0 to +60 C, non-condensing
Compliance	CE / RoHS
Communication Interface	I <sup>2</sup> C, SPI, UART, analog servo <i>Input directly to M3-RS</i>
Controller	Integrated into stage, 64 MIPS <i>NO external controller needed</i>

<b>Standard Mounted Mirrors (included in kit)</b>	
Size – Short Mirror	3 x 5 x 0.4 mm
Size – Long Mirror	11 x 5 x 0.4 mm
Material	Float Glass
Coating	Protected Aluminum (MgF2)
Operational Bandwidth	0.350 – 4.0 µm
R <sub>avg</sub> Reflectivity (0.350 – 4.0 µm)	90%
Maximum Beam Diameter	2 mm
Flatness (632 nm)	λ/4 over any 2 mm length
Surface Quality	60 – 40 scratch/dig
CW Damage Threshold (4 µm)	6 W/cm <sup>2</sup>
Pulsed Damage Threshold (1 µsec pulses, 350 nm, 20 Hz)	0.3 J/ cm <sup>2</sup>

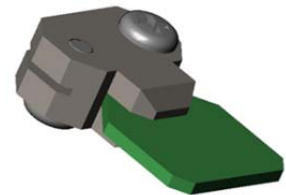

\* With inertial load of mounted mirror M3-RS-U-Mirror-01-11

Internal Stage Inertia	0.39 g-mm <sup>2</sup>
Mirror Clamp	0.45 g-mm <sup>2</sup>
Mirror	0.15 g-mm <sup>2</sup>
Total Inertia	0.99 g-mm <sup>2</sup>

## Closed-Loop versus Open-Loop Stepping

An important and standard feature of the M3-RS-U Smart Rotary Stage is the ability to move in using both open-loop and closed-loop commands from the SPI, I2C or UART interface.

### Closed-loop stepping

Closed-loop stepping achieves specific shaft angles in minimum increments equal to the resolution of the embedded absolute position sensor. The desired shaft angle is achieved by:

- (1) Receiving the target command from the host processor
- (2) Reading the current shaft angle from the position sensor
- (3) Calculating and commanding the appropriate drive signal for the piezoelectric motor to achieve the desired angle
- (4) Repeating steps (2) and (3) until the target angle is achieved

Closed-loop stepping provides superior repeatability and accuracy, but requires more time to “step and settle” when compared to open-loop stepping.

### Open-loop stepping

Open-loop stepping rotates the shaft using only the piezoelectric motor that is commanded to move in “sub-steps.” The magnitude of the sub-steps is smaller than the internal position sensor resolution and allows more precise shaft movement. This is particularly useful in applications that have an external sensor with better resolution than the internal sensor or where very fast “step and settle” performance is required.

Motor sub-steps are commanded from the host processor by defining the Direction, Velocity, and On-time for the piezoelectric motor. The combination of Velocity and On-time determines the magnitude of each sub-step.

Many factors impact the accuracy of open-loop steps including the external load, direction, absolute angle, and magnitude of the step. Options for improving the precision of open-loop stepping include:

- a. Calibration of motor sub-step size for specific operation conditions using an external sensor and fixed look-up table.
- b. Real-time calibration using the internal closed-loop sensor to measure the average size of multiple motor sub-steps.

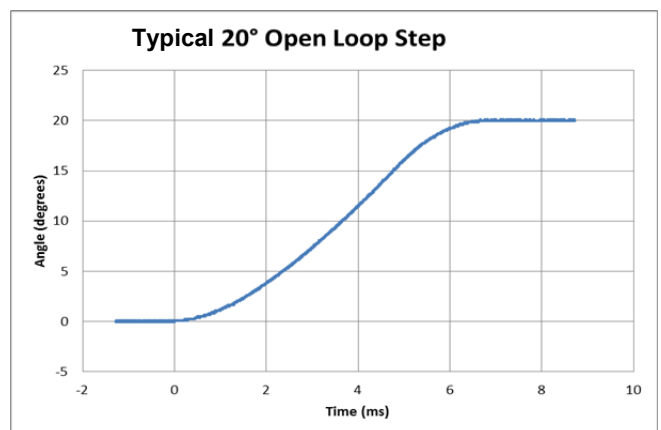
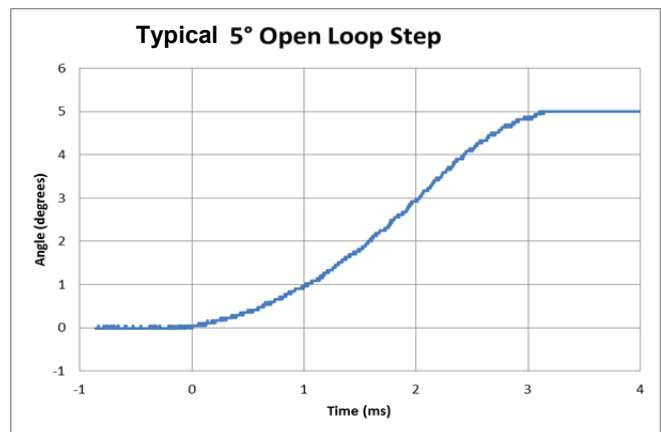
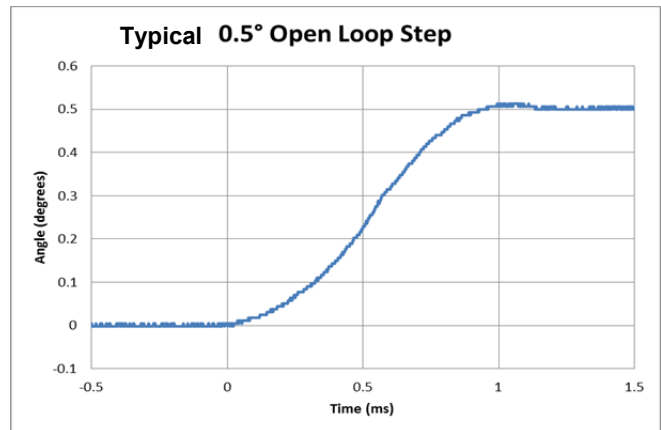
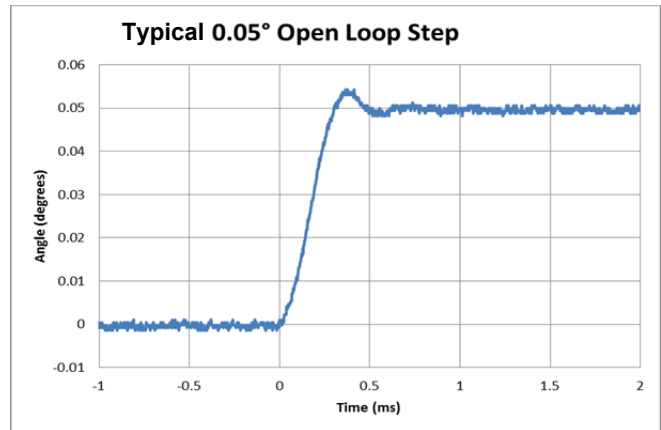

## Drawings

### Smart stages with mounted mirrors, laser and base

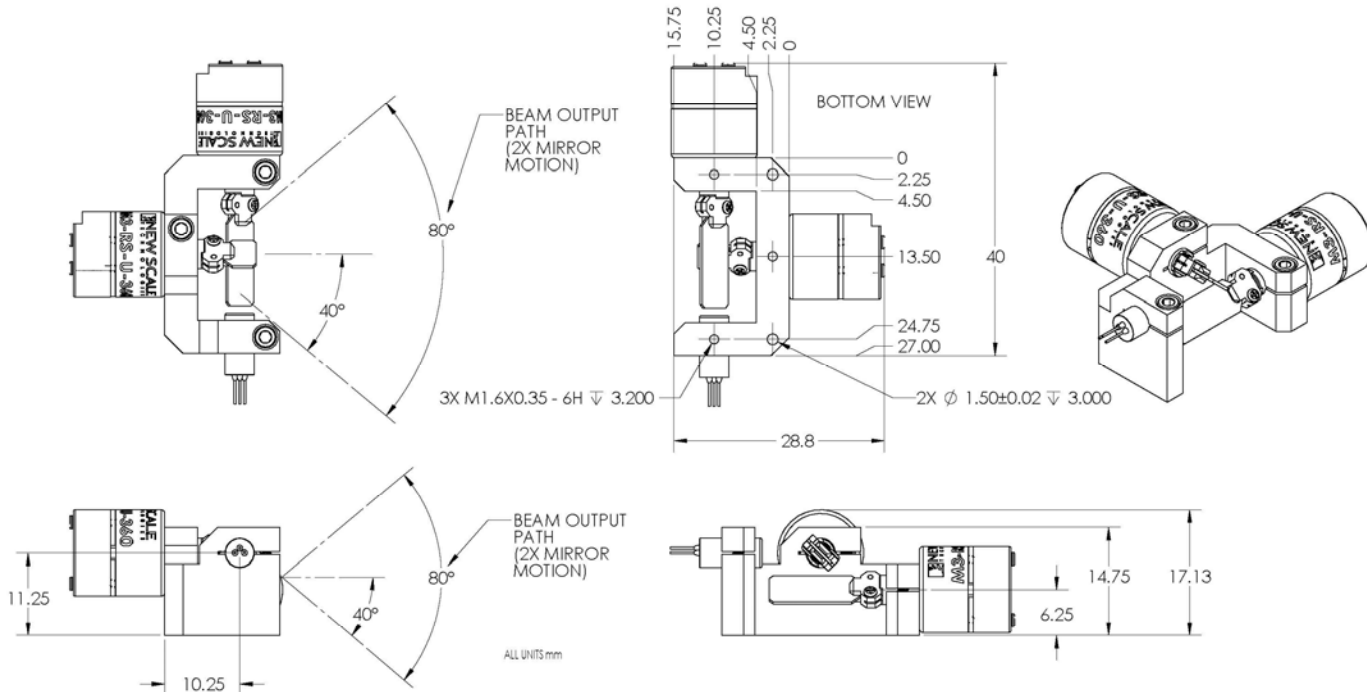

## Demo board

Included in the Developer's Kit for evaluation. NOT REQUIRED FOR BEAM STEERING.

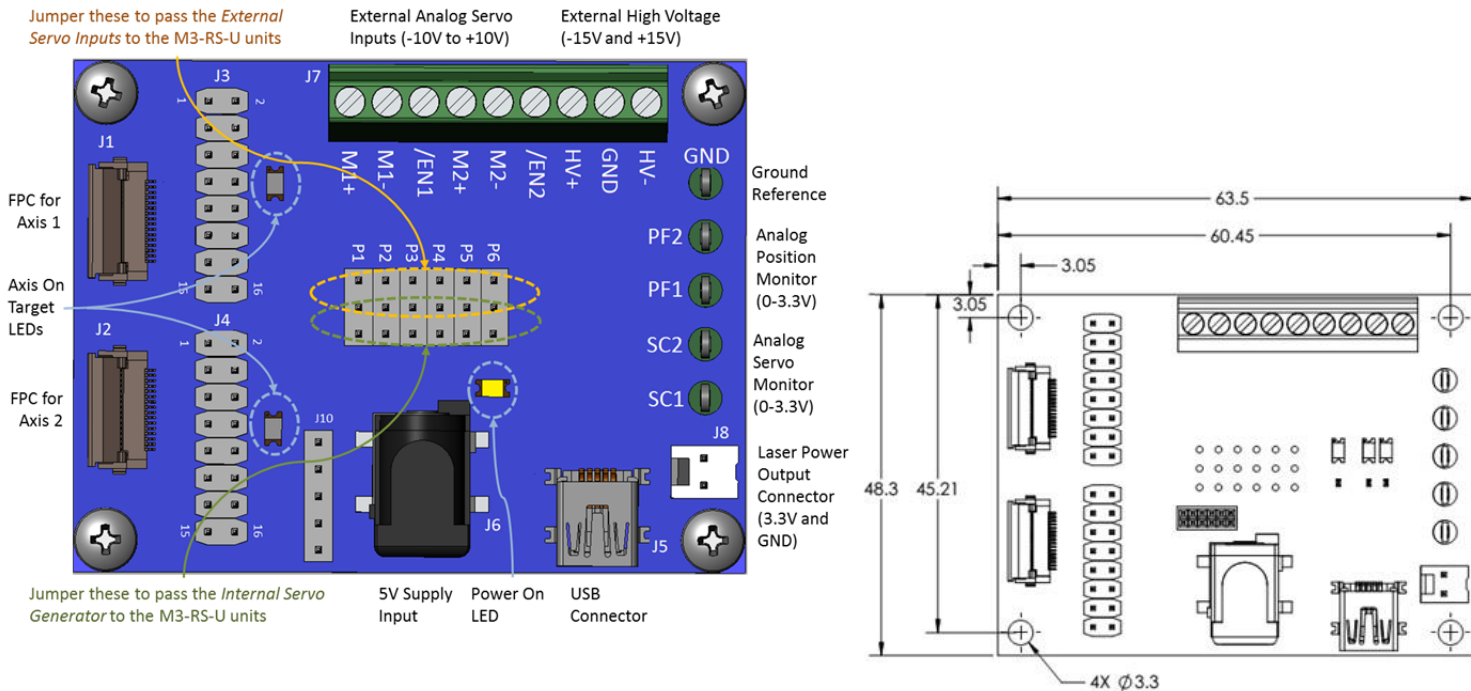

## Ordering information

Developer's Kit	Description
<b>DK-M3-RS-U-2M-20-L</b>	<b>Developer's Kit, Two-Axis Two-Mirror Beam Steering System</b> <ul style="list-style-type: none"> <li>Two M3-RS-U-360 Rotary Stage Positioning Modules with embedded controller and straight FPC</li> <li>One M3-RS-U-Mirror-01-03, mounted to stage</li> <li>One M3-RS-U-Mirror-01-11, mounted to stage</li> <li>One 650nm collimated laser</li> <li>Base</li> <li>Demo board and cables for testing and PC connection</li> <li>Power supply</li> <li>New Scale Pathway™ Software</li> </ul>
Optional Components	Description
<b>M3-RS-U-360</b>	<b>Rotary Stage Positioning Module</b> Piezo smart stage with built-in controller and M3-RS-U-FPC-0-150 flex cable <i>Two stages are included in the kit.</i>
<b>M3-RS-U-Mirror-01-03</b>	<b>Mounted mirror, 3 x 5 x 0.4 mm</b> Inertia 0.50 g-mm <sup>2</sup> <i>One, 3-mm mirror is included in the kit.</i>
<b>M3-RS-U-Mirror-01-11</b>	<b>Mounted mirror, 11 x 5 x 0.4 mm</b> Inertia 0.60 g-mm <sup>2</sup> <i>One, 11-mm mirror is included in the kit.</i>
<b>M3-RS-U-FPC-0-150</b>	<b>FPC cable with straight exit from stage</b> 150 mm length (standard cable, included with stage)

## Optional components

### Mounted Mirrors

Each kit includes one, 3-mm long mounted mirror and one, 11-mm long mounted mirror pre-attached to the stages.

You may order additional mounted mirrors if desired. Tools to attach the mounted mirrors to the stage are included in the kit.

### FPC Cables

Each kit includes two flexible printed circuit cables for stage input. You may purchase cables in other lengths, with straight or 90-degree exit angles.

### Additional Stages

Each kit includes two rotary stage positioning modules. Additional modules may be ordered separately.

## Additional information

Visit the website for CAD files and user manuals (registration required):

<http://www.newscaletech.com/downloads/software-cad-manuals.php>